

1/16 DIN, Easy-to-Operate
Combination Counter and Timer

- Operation selectable as preset counter or timer
- 6-digit LCD display—
Present Value: 8 mm (0.32 in)
Set Value: 4 mm (0.16 in)
- Nonsignificant zeros suppressible from preset or count value display
- Selectable power supply voltages
24 to 240 VAC and 12 to 120 VDC
- Memory protection
- 4 programmable output modes available for both counter and timer functions



Ordering Information

■ Counter/Timer

Mounting style			Surface/flush mounting			
Operating function			Preset counter/timer (selectable)			
Operating system (mode)			Counter: reversible (Three input modes and four operating modes are selectable) Timer: time-limit operation, integrating operation (Four operating modes are selectable)			
Backup power supply for memory protection			Provided: Approx. 10 years at 20° C (68° F)			
Number of counts			0 to 999999 (6 digits)			
Timing ranges			0.00 to 9999.99 s, 0.0 to 99999.9 min., 0.0 to 99999.9 h (6 digits)			
External connection			Socket			
Display type			6-digit backlit LCD; 8 mm (0.32 in) Present Value, 4 mm (0.16 in) Set Value			
Count and reset input for counter function; reset and gate input for timer function			No-voltage input (See Note.) (solid-state/contact input)		Voltage input	
Control output			Contact	Solid-state	Contact	Solid-state
Power supply/ counting speed	AC	30 cps	H8CA-SAL	H8CA-SALS	H8CA-SALV	H8CA-SALVS
		1 kcps	H8CA-SAH	H8CA-SAHS	H8CA-SAHV	H8CA-SAHVS
	DC	30 cps	H8CA-SDL	H8CA-SDLS	H8CA-SDLV	H8CA-SDLVS
		1 kcps	H8CA-SDH	H8CA-SDHS	H8CA-SDHV	H8CA-SDHVS

Note: Do not use the contact input at a counting speed of 1 kcps.

■ Accessories (Order Separately)

Description		Part number	
Sockets	11-pin	Bottom surface or track mounting, top screw terminals	P2CF-11
		Bottom surface or track mounting, top screw terminals, finger safe terminal conforms to VDE0106/P100	P2CF-11-E
		Back mounting, for use with Y92F-30 mounting adapter, bottom screw terminals	P3GA-11
Panel mounting adapter		Fits behind panel, ideal for side-by-side installation. Use P3G□-□sockets	Y92F-30
NEMA 4 cover		Waterproof front cover	Y92A-48N
Mounting track	DIN rail, 50 cm (1.64 ft) length; 7.3 mm thick		PFP-50N
	DIN rail, 1 m (3.28 ft) length; 7.3 mm thick		PFP-100N
	DIN rail, 1 m (3.28 ft) length; 16 mm thick		PFP-100N2
End plate			PFP-M
Spacer			PFP-S

Specifications

■ Ratings

Supply voltage	AC	24 to 240 VAC, 50/60 Hz
	DC	12 to 120 VDC (20% max. permissible ripple)
Operating voltage range		90 to 110% of rated voltage
Power consumption (See Note 1.)		Approx. 2.2 VA (at 240 VAC, 50 Hz) Approx. 1 W (at 120 VDC)
Max. counting speed of CP1 and CP2		In counter function mode: 30 cps (contact and solid-state inputs): Minimum pulse width: 16.7 ms (ON/OFF ratio: 1:1) 1 kcps (solid-state input): Minimum pulse width: 0.5 ms (ON/OFF ratio: 1:1)
Reset system		External reset (common to contact and solid-state inputs) and manual reset Minimum reset signal width: 20 ms
Start and gate response time		In timer function mode: Start and gate response time (common to contact and solid-state inputs): L-type: 16.5 ms H-type: 0.5 ms
Count and reset inputs for counter function/ start and gate inputs for timer function		No-voltage input: (See Note 2.) Maximum short-circuit impedance: 1 kΩ Short-circuit residual voltage: 0.5 V max. (1.3 V max.) Minimum open impedance: 100 kΩ Voltage input: 5 to 30 V at "High" level 0 to 2 V at "Low" level Input impedance: Approx. 4.7 kΩ
Control output		Contact output type: SPDT 250 VAC 3 A p.f.=1 (resistive load) Solid-state output type: Open collector 30 VDC max. 100 mA max.
Approvals		UL / CSA / SEV

Note: 1. On power application, the following inrush current flows for 0.5 ms.
3.7 A at 240 VAC, 2.3 A at 120 VDC

2. The source current output from each input terminal when using no-voltage input is 2 mA max.

■ Characteristics

In timer function mode	Repeat accuracy	±0.05% ±0.05 s
	Setting error	±0.1% ±0.005 s
	Variation due to voltage change	±0.05% ±0.05 s max.
	Variation due to temperature change	
Insulation resistance	100 mΩ min at 500 VDC	
Dielectric Strength	1,500 VAC 50/60 Hz for 1 minute	
Vibration	Mechanical durability: 10 to 55 Hz, 0.75 mm (0.030 in) double amplitude Malfunction durability: 10 to 55 Hz, 0.3 mm (0.012 in) double amplitude	
Shock	Mechanical durability: approx. 30 G Malfunction durability: approx. 10 G	
Ambient temperature	Operating: -10° to 55° C (14° to 131° F) Storage: -25° to 65° C (-13° to 149° F)	
Humidity	35 to 85% RH	
Service life	Mechanically: 10,000,000 operations min. Electrically: See "Engineering Data"	
Weight	Approx. 130 g (4.59 oz)	

Note: Operate time of output circuit is included in overall error.

Engineering Data

■ Electrical Service Life

Resistive Load

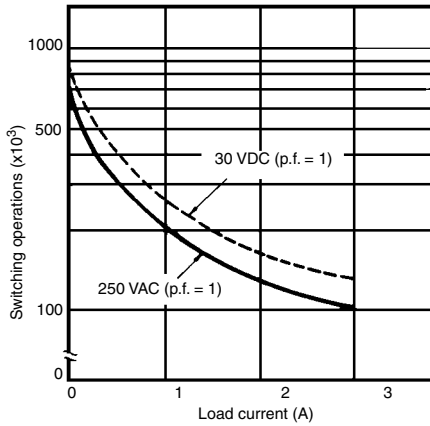

Inductive Load

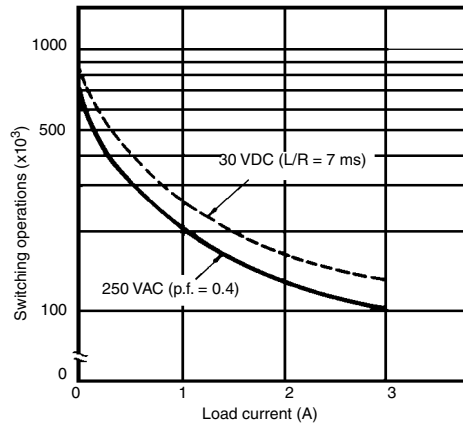

Timing Charts

■ In Counter Function Mode

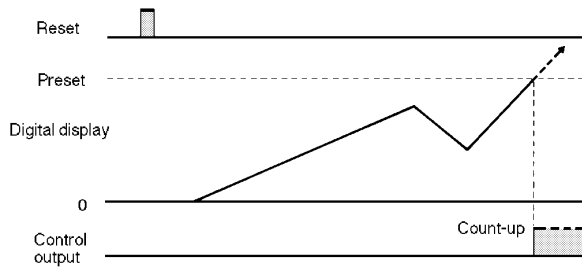

■ In Timer Function Mode

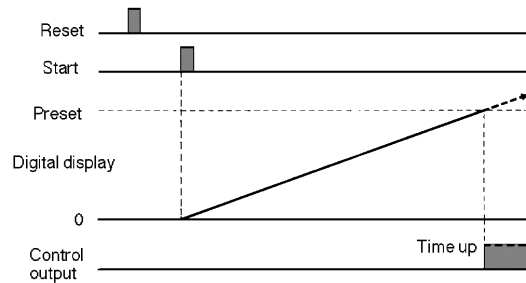

■ Count Output Modes

In the timing charts below, "A" is the minimum signal width. "B" must be at least 1/2 of minimum signal width, otherwise, signals may not be counted if the minimums for "A" and "B" are not met.

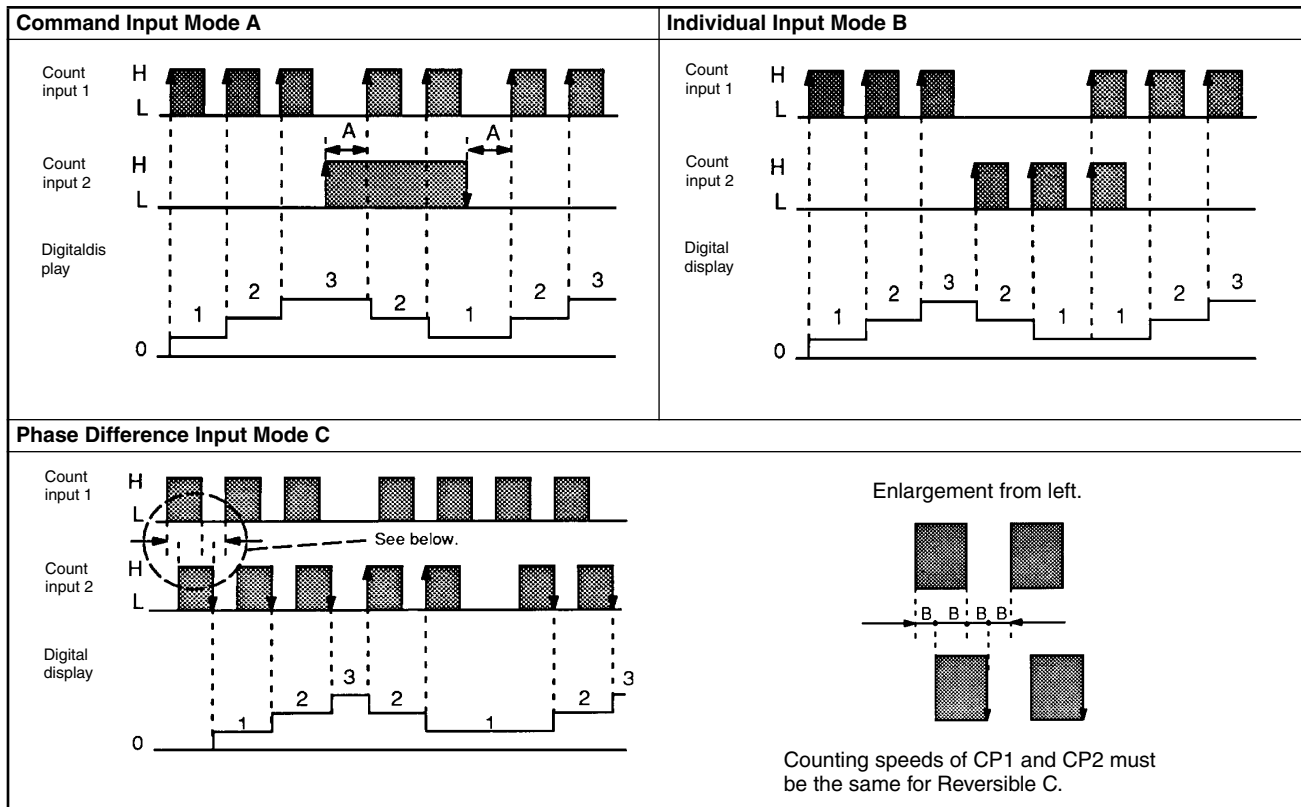

■ Functions of Input Signals

Input type	Counter output	Signal high	Signal low
No-voltage	Contact	The contact turns ON	The contact turns OFF
	Solid-state	The open collector transistor is in the ON state	The transistor is in the OFF state
Voltage	Both	Input signal voltage level is 5 to 30 V	Input signal voltage level is 0 to 2 V

Input	Counter mode A (command input)	Counter mode B (individual input)	Counter mode C (phase difference)	Timer operation
Count input 1	Count input: The count value is increased by one when count input 2 (CP2) voltage goes low. The count value is decreased by one when count input 2 (CP2) voltage goes up.	Addition count input	The count value is increased by one when phase of count input 2 (CP2) is delayed with respect to phase of count input 1 (CP1). The count value is decreased by one when phase of count input 2 (CP2) is ahead with respect to phase of count input 1 (CP1).	Start input
Count input 2	Addition/subtraction control	Subtraction count input		Gate input

■ Output Modes in Both Counter and Timer Operations

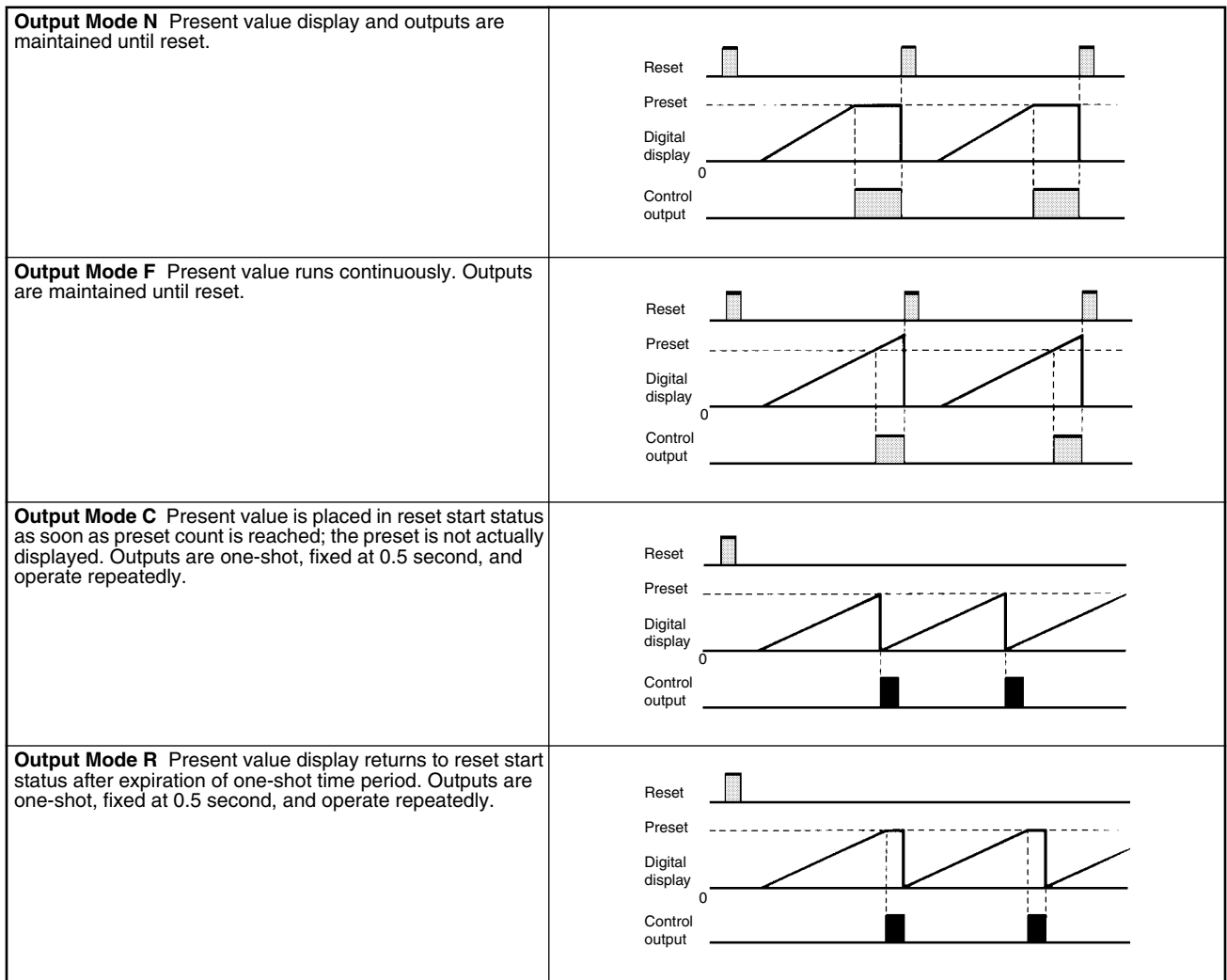

■ Sustained control output

■ One-shot control output, set to 0.5 second

Dimensions

Unit: mm (inch)

■ H8CA-S Counter/Timer

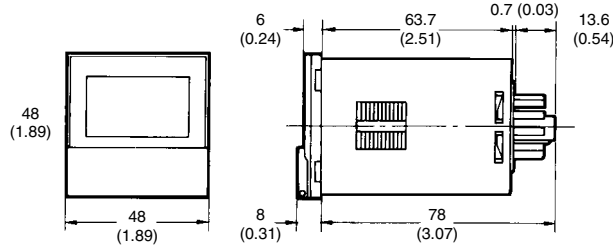
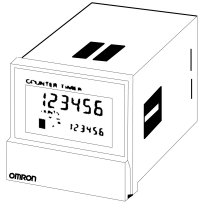

Panel cutout

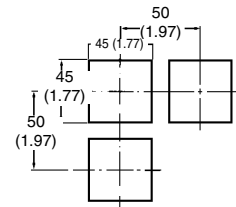

Note: Recommended panel thickness is 1 to 3.2 mm. Panel cutout conforms to DIN 43700.

■ Accessories

P2CF-11 Track Mounting/Front Connecting Socket

Conforming to VDE0106/P100

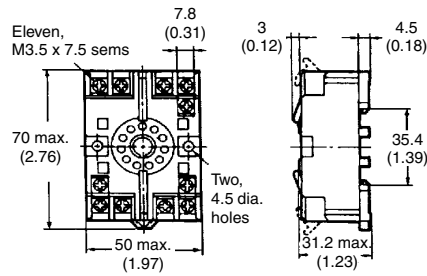
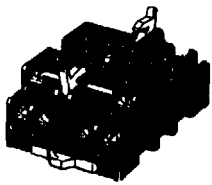

Terminal arrangement

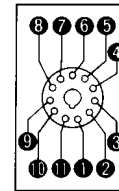

Mounting holes

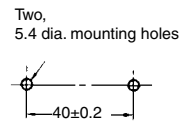

P2CF-11-E Finger Safe Terminal Type

Conforming to VDE0106/P100

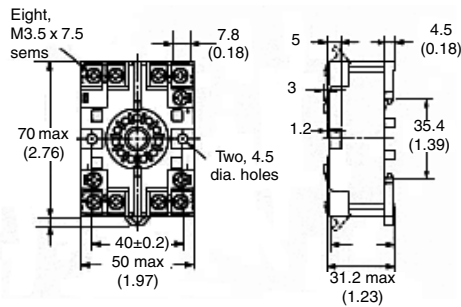
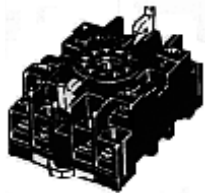

P3GA-11 Back Mounting Socket

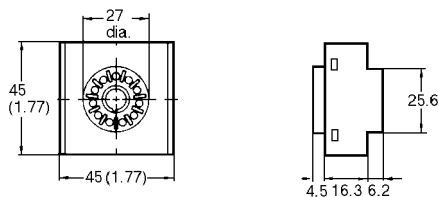
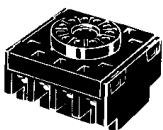

Terminal arrangement

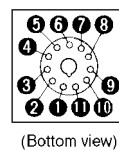

Y92F-30 Panel Mounting Adapter

Adapter installs behind the panel. It is ideal for side-by-side installation. Use a P3GA-11 socket.

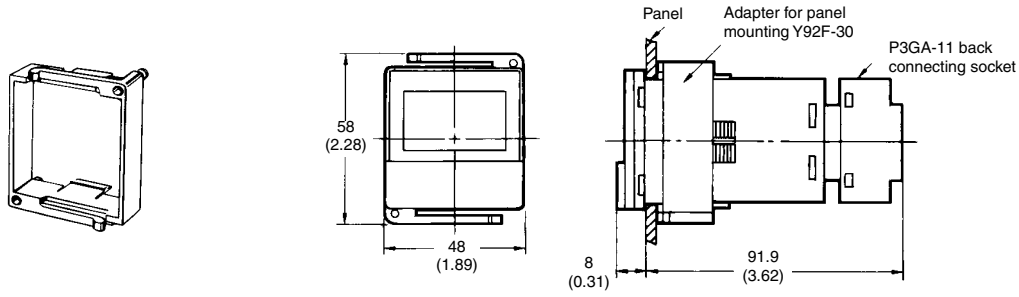

PFP-100N, PFP-50N Mounting Track

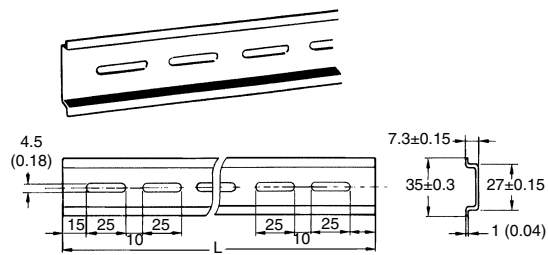

PFP-100N2 Mounting Track

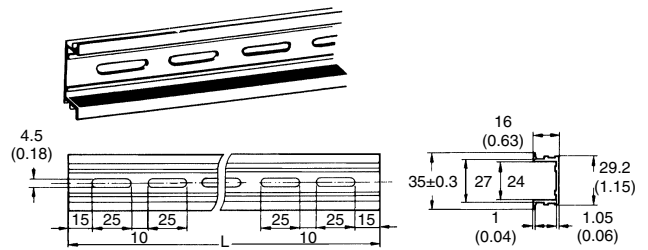

L: Length

1 m	PFP-100N
50 cm	PFP-50N
1 m	PFP-100N2

PFP-M End Plate

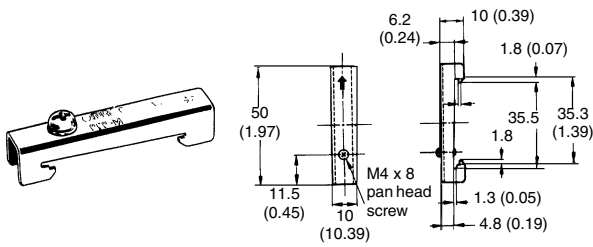

PFP-S Spacer

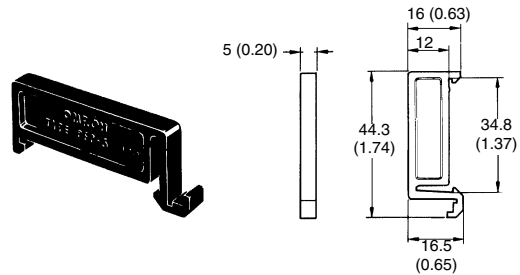

Nomenclature

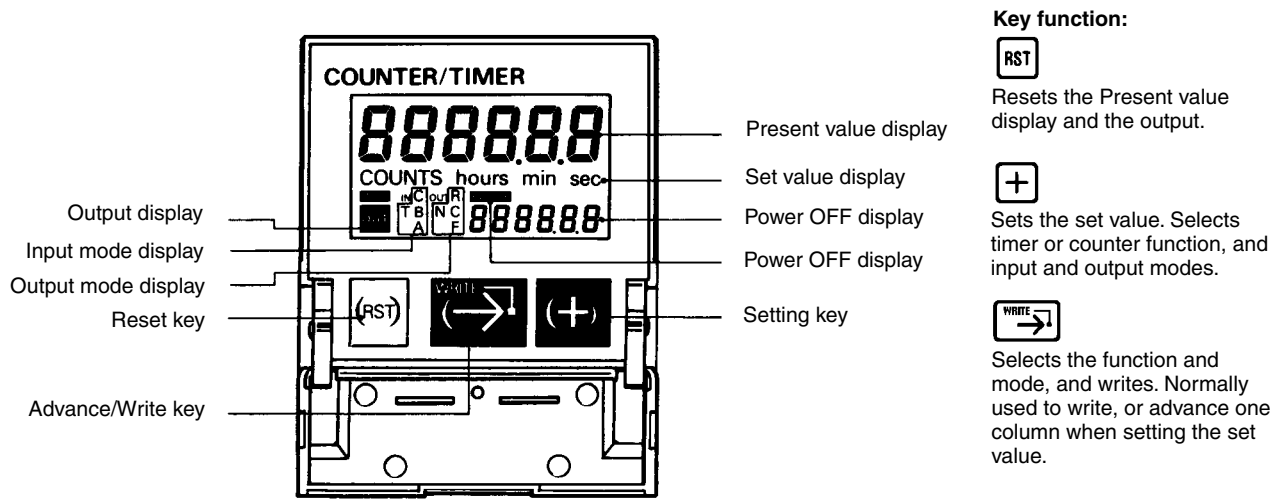

Programming

■ Selecting Function Mode

Select timer or counter function first. It is not necessary for power to be ON to set this function. When the H8CA-S is shipped, it is set to counter function, input mode "A," output mode "N," and pre-set value 1.

1. Terminals 1 and 3 must be connected to select timer or counter function using the **+** key.

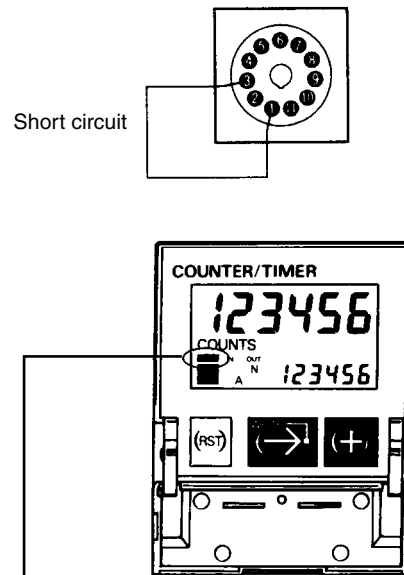

"**MODE**" is lit. The function, input mode, or output mode display will be blinking. (The Power OFF display will stop blinking when power comes ON.)

2. Press the **[+]** key to select counter or timer function, input mode, and output mode. The characters below will flash when the **[+]** key is pressed.

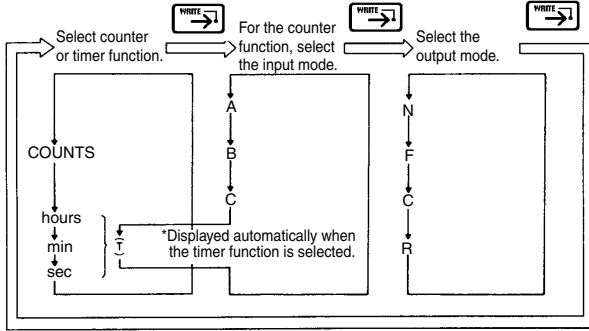

- Press the **[+]** key until the desired function appears.
- Press the **[+]** key until the desired function appears.
- Press the **[+]** key until the desired function appears.
- Press the **[↔]** key to write the desired input mode.
- Press the **[↔]** key to write the desired input mode.
- Press the **[↔]** key to write the desired input mode.

■ Setting Example

1. Selecting the counter function with input mode "A" and output mode "N." (Terminals 1 & 3 connected.)

"**MODE**" lights on the display.

"COUNTS" will begin blinking when the **[+]** key is pressed. (Press the keys until the desired place is reached.)

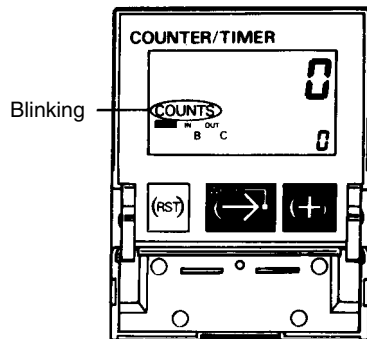

Press the **[↔]** key. "COUNTS" will stop blinking, and one of the input modes will be blinking.

Press the **[+]** key until input mode "A" begins blinking.

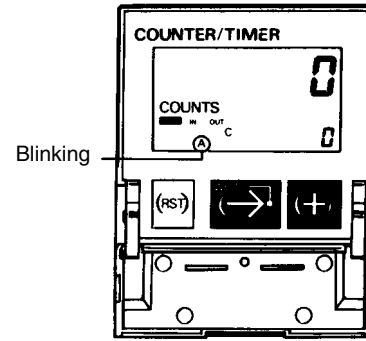

Press the **[↔]** key. "A" will stop blinking, and one of the output modes will begin blinking.

Press the **[+]** key until output mode "N" begins blinking.

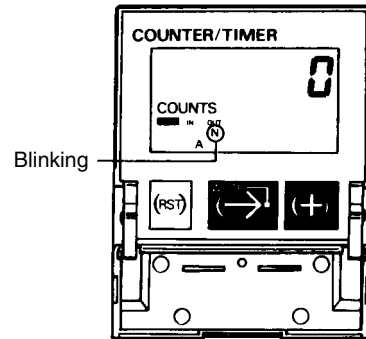

Disconnect terminals 1 and 3 before setting values. When terminals 1 and 3 are disconnected, the "**MODE**" display will turn OFF and output mode "N" will stop blinking.

Always disconnect terminals 1 and 3 when finished selecting the function. Values cannot be preset if terminals 1 and 3 are connected.

2. Selecting the timer function with "sec" and output mode "N." (Terminals 1 and 3 connected.)

If set for timer, "sec" will begin blinking when the **[+]** key is pressed. (Press the keys until the desired place is reached.)

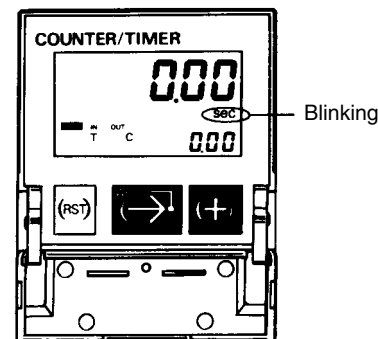

Press the **[↔]** key. "sec" will stop blinking, and one of the output modes will begin blinking. The INPUT MODE will automatically enter "T."

Press the **[+]** key until input mode "N" begins blinking.

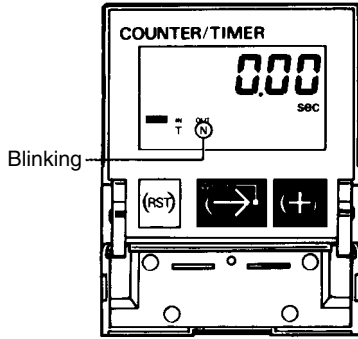

Press the **[MODE]** key until the desired digit begins blinking.

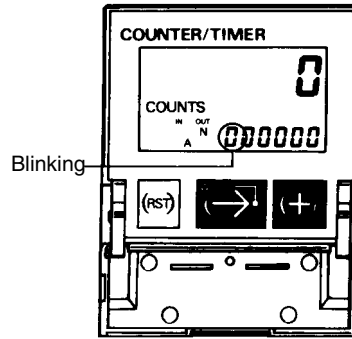

Disconnect terminals 1 and 3 before setting values. When terminals 1 and 3 are disconnected, the "MODE" display will turn OFF, and output mode "N" will stop blinking.

Always disconnect terminals 1 and 3 when finished selecting the function. Values cannot be preset if terminals 1 and 3 are connected.

■ Presetting Numeric Values

Preset values after selecting the function. Values can be preset whether the power supply is ON or OFF.

Press the **[+]** key to set the desired value.

Continue pressing the **[MODE]** and **[+]** keys until the smallest digit has been set.

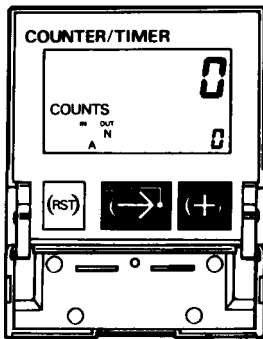
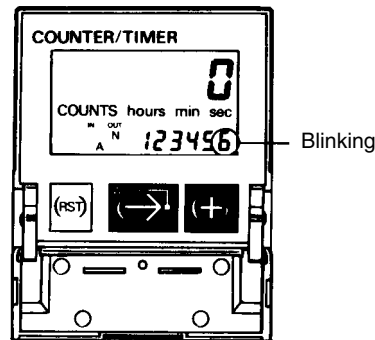

To complete presetting, press the **[MODE]** key so that no place on the display is blinking.

* Preset unnecessary higher digits at 0. (i.e. 000015)

Note: The output will go ON if the set value is 0 (0.0 or 0.00) and the displayed count is also 0 (0.0 or 0.00). In this case, press reset after presetting, and the output will go OFF.

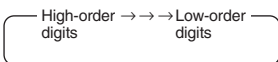

key: Press this key to move to the next column.



key: Press this key to increment values.



Connections

Terminal Arrangements

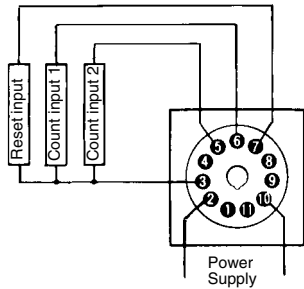

In Counter Function Mode

Note: When the control power supply is DC, terminals ② and ③ are internally connected.

Mode Switch (① & ③)

When these terminals are short-circuited, set the input and output modes with the RESET key, not the MODE key.

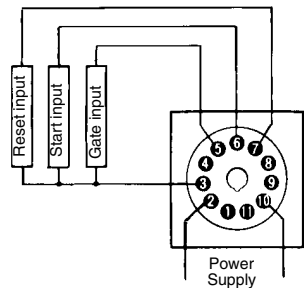

In Timer Function Mode

Note: When the control power supply is DC, terminals ② and ③ are internally connected.

* Check the operating status of terminals ③ and ④ (see table below) before connecting or disconnecting them.

Timer Control Terminals ③ & ④

Be sure these terminals are not connected when using the H8CA-S as a counter. These terminals are used as shown below only when H8CA-S functions as a timer.

Terminals ③ & ④	Operation
Short-circuited	Timer operation temporarily interrupted when power failure occurs in control power supply
Open	Timer operation continues even when power failure occurs in control power supply

Power Supply Connection

Connect power supply across terminals ② and ⑩ and apply one of the specified voltages. (Pay special attention to the polarity when using a DC-operated model.)

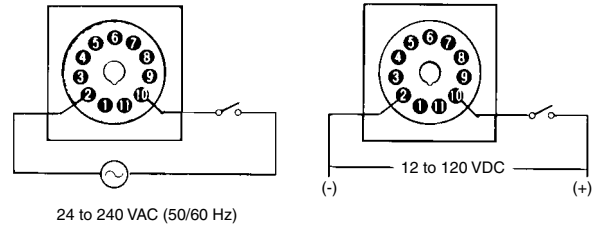

Caution

Do not touch the input terminals while power is supplied to the H8CA-S or you may experience an electric shock, since this counter does not have a built-in power transformer. Use of a model rated at a low DC voltage is recommended when the counter is installed at a location where the input terminals are easily accessible.

Note: When connecting external signal input contacts and transistors, use a power supply having a power transformer whose primary and secondary circuits are isolated from each other with the secondary circuit not grounded, for the input devices, to prevent current feedback and short-circuiting.

Correct:

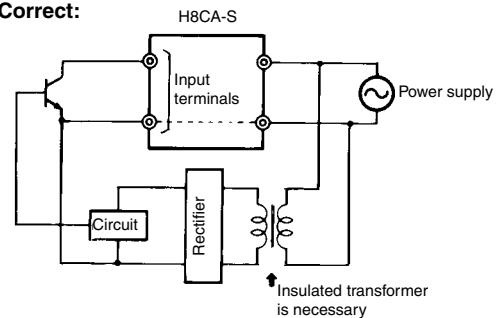

Incorrect:

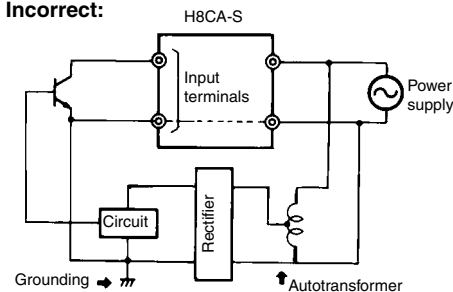

Note: Do not arrange the peripheral circuits of the counter in either way, as the internal circuit may be destroyed, rendering the counter unoperational.

To input a signal from a single input contact to several H8CA-Ss at the same time, be sure to connect the terminals of the same numbers in parallel.

■ Connection of Load Circuit Control Output

Contact Output Type

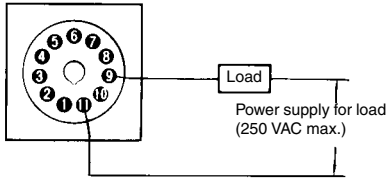

Note: The load is turned on when the set count or time is up.

Solid-State Output Type

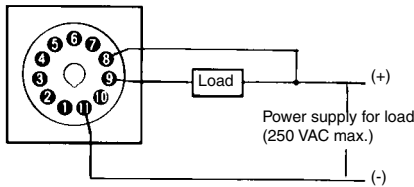

Note: 1. The load is turned on when the set count or time is up.
2. Be sure to connect terminal ⑩ when an inductive load is connected.

Output Delay Time

The output delay time is the time from the application of the count input signal of the preset value until the generation of control output. The delay time differs depending on counting speed and model of control output used, as shown in the table below.

Type of control output	Max. counting speed of rated time	Output delay time
Contact output	30 cps	Common to hours, minutes and seconds
	1 kcps	
Solid-state output	30 cps	30 ms max.
	1 kcps	2 ms max.

■ Reset Input Connection

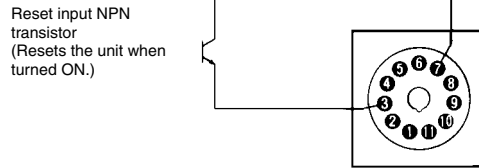
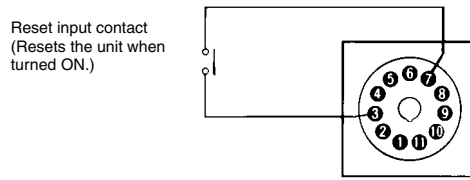

Voltage Input Type

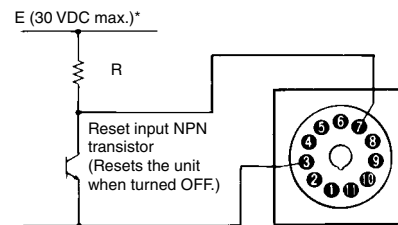
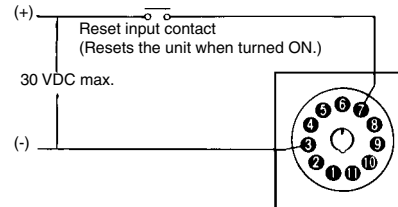

*At "High" level
4.7 E
4.7 + R (V) 5 V

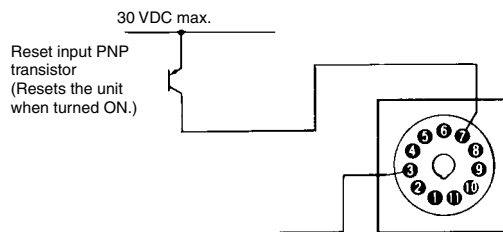

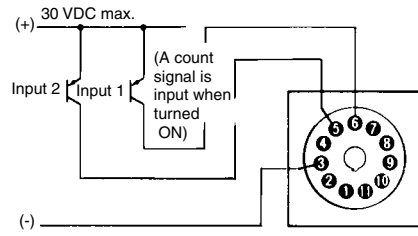
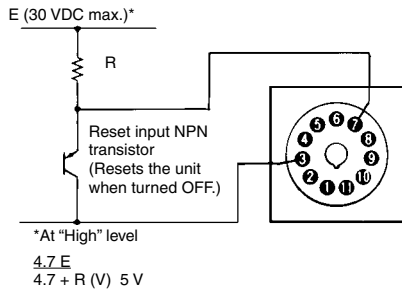

■ Connection of Count Inputs

No-Voltage Input Type

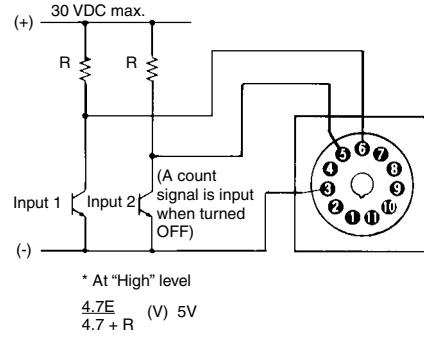
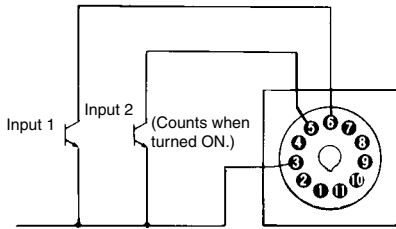
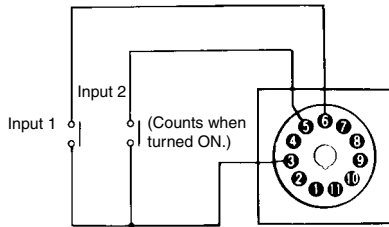

Voltage Input Type

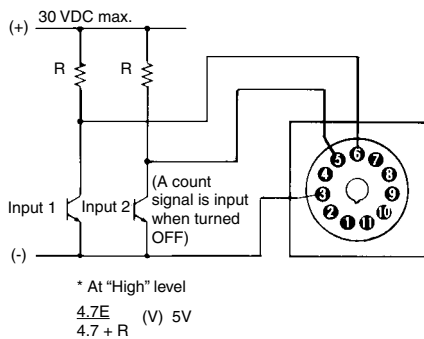
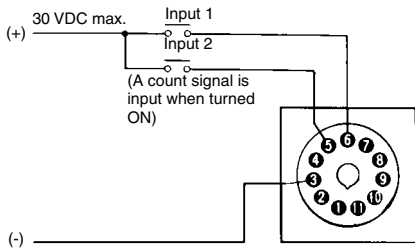

Operations

Power Failure Detection

The H8CA-S is capable of detecting and indicating a power failure on the display. Before power application or when a power failure occurs, the "PW OFF" display flickers indicating that the control power supply is off.

Relation Among t_1 , t_2 , and Supply Voltage

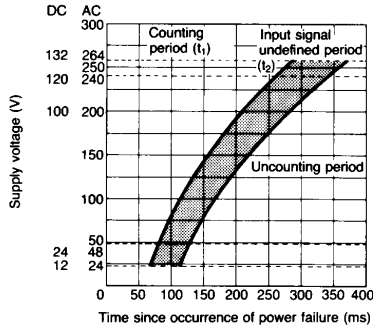

When a power failure occurs, there is a period during which the counter does not respond to the input signal, as shown below, because of the lag in the rise in the internal circuit voltage.

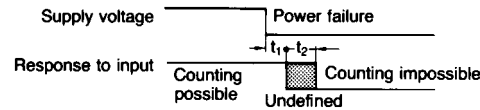

Likewise, on power application, there is a period during which the counter does not respond to the input signal, as shown below, because of a lag in the rise in the internal circuit voltage.

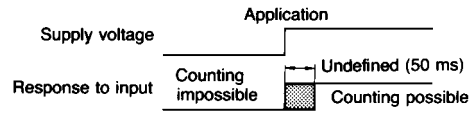

Operation and Display

"OUT" is displayed when counting or timing is complete.

When "MODE" lights on display, terminals 1 and 3 are connected. In this case, it is not possible to preset values. Be sure to disconnect the terminals.

The H8CA-S uses "regular read format," so the preset values can be changed whether power is ON or OFF.

When changing the preset value during timer or counter operation, a signal will be output when the new value is the same as the displayed value.

The front panel keys operate at a touch. Do not press the keys with excessive force or tools, such as a screwdriver. Press only with fingers.

After presetting values, part of the display might be blinking. The H8CA-S will operate normally in this condition, but press the [→] key so that characters do not blink.

Mounting

There is no limitation in mounting direction. However, avoid mounting the unit at an angle.

Surface Mounting

Using P2CF-11 Front Connecting Socket

When a number of the H8CA-S are mounted in a vertical line or when an H8CA-S is mounted close to an obstacle such as a wiring duct, be sure to provide a separation of approximately 20 mm (0.79 in) between adjacent units or between the unit and the obstacle to allow room for engagement and disengagement of hooks as shown below.

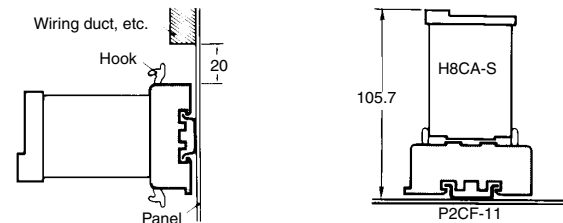

Panel Mounting

Using Y92F-30 Adapter for Flush Mounting

Insert the H8CA-S into a square-cut hole from the front of the mounting panel; insert the adapter from the rear of the H8CA-S until the clearance between the panel surface and the adaptor is minimized. Then secure the H8CA-S with two screws onto the panel.

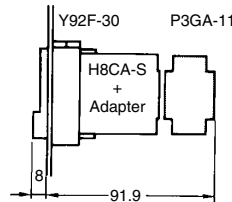

When mounting two or more counters in a vertical line, arrange all the adapters so that the molded springs of the Y92F-30 adapters are positioned on the right and left sides.

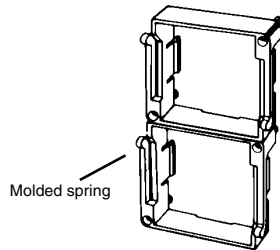

When mounting two or more counters in a horizontal line, arrange all the adapters so that the molded springs of the Y92F-30 adapters are positioned on the top and bottom sides.

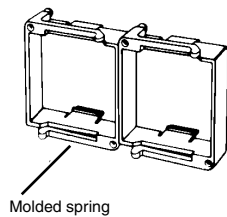

By attaching the P3GA-11 back connecting socket to a panel mounted H8CA-S, wiring can be performed in the same manner as the front connecting socket.

Removal

To remove an H8CA-S panel mounted with a Y92F-30 adapter, loosen the two screws of the adapter, pry up the top and bottom hooks of the adapter, and pull the H8CA-S out from the front of the panel.

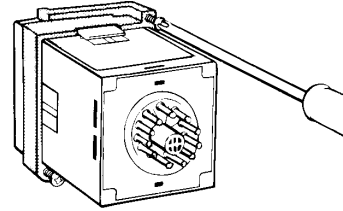

Caution

The H8CA-S has a built-in lithium battery. Be sure to dispose of the old H8CA-S properly, as lithium batteries are likely to explode if incinerated.

ALL DIMENSIONS SHOWN ARE IN MILLIMETERS. To convert millimeters into inches, divide by 25.4

OMRON

OMRON ELECTRONICS LLC

One East Commerce Drive
Schaumburg, IL 60173

1-800-55-OMRON

OMRON ON-LINE

Global - <http://www.omron.com>
USA - <http://www.omron.com/oei>
Canada - <http://www.omron.com/oci>

OMRON CANADA, INC.

885 Milner Avenue
Scarborough, Ontario M1B 5V8

416-286-6465