

Microwave RFID System **V690 Series** User's Manual

Read/Write Antenna, ID Tag, and Link Unit

Read/Write Antenna

Model V690-HMG01A

ID Tag

Model V690-D8KR01A

Link Unit

Model V690-L01

Introduction

Thank you for choosing a V690-series Microwave-type RFID System. The V690 Series was developed by OMRON based on our advanced technology and extensive experience. This user's manual describes the functions, performance, and usage of the V690 Series.

When you use V690-series products, observe the following precautions:

- V690-series products must be operated by a qualified electrical engineer with expert knowledge on electrical systems.
- Read this user's manual carefully, understand the V690-series products fully, and use them correctly.
- Keep this user's manual in a safe place where it is easily accessible for future reference.

Application Considerations

When you use the V690 Series in the following environments, operate it within the ratings and functions, take sufficient safety measures, such as installing a fail-safe system, and consult your nearest OMRON representative.

- (1) Use in conditions or environments not described in this manual
- (2) Use for nuclear energy control, railroads, aeronautical systems, cars, combustion equipment, medical equipment, amusement facilities, safety devices, etc.
- (3) Use for applications that may have a serious influence on people's lives and property or any other way requiring a high level of safety.

Read and Understand this Manual

Please read and understand this manual before purchasing the product. Please consult your OMRON representative if you have any questions or comments.

Warranty and Limitations of Liability

WARRANTY

OMRON's exclusive warranty is that the products are free from defects in materials and workmanship for a period of one year (or other period if specified) from date of sale by OMRON.

OMRON MAKES NO WARRANTY OR REPRESENTATION, EXPRESS OR IMPLIED, REGARDING NON-INFRINGEMENT, MERCHANTABILITY, OR FITNESS FOR PARTICULAR PURPOSE OF THE PRODUCTS. ANY BUYER OR USER ACKNOWLEDGES THAT THE BUYER OR USER ALONE HAS DETERMINED THAT THE PRODUCTS WILL SUITABLY MEET THE REQUIREMENTS OF THEIR INTENDED USE. OMRON DISCLAIMS ALL OTHER WARRANTIES, EXPRESS OR IMPLIED.

LIMITATIONS OF LIABILITY

OMRON SHALL NOT BE RESPONSIBLE FOR SPECIAL, INDIRECT, OR CONSEQUENTIAL DAMAGES, LOSS OF PROFITS OR COMMERCIAL LOSS IN ANY WAY CONNECTED WITH THE PRODUCTS, WHETHER SUCH CLAIM IS BASED ON CONTRACT, WARRANTY, NEGLIGENCE, OR STRICT LIABILITY.

In no event shall the responsibility of OMRON for any act exceed the individual price of the product on which liability is asserted.

IN NO EVENT SHALL OMRON BE RESPONSIBLE FOR WARRANTY, REPAIR, OR OTHER CLAIMS REGARDING THE PRODUCTS UNLESS OMRON'S ANALYSIS CONFIRMS THAT THE PRODUCTS WERE PROPERLY HANDLED, STORED, INSTALLED, AND MAINTAINED AND NOT SUBJECT TO CONTAMINATION, ABUSE, MISUSE, OR INAPPROPRIATE MODIFICATION OR REPAIR.

Application Considerations

SUITABILITY FOR USE

OMRON shall not be responsible for conformity with any standards, codes, or regulations that apply to the combination of products in the customer's application or use of the products.

At the customer's request, OMRON will provide applicable third party certification documents identifying ratings and limitations of use that apply to the products. This information by itself is not sufficient for a complete determination of the suitability of the products in combination with the end product, machine, system, or other application or use.

The following are some examples of applications for which particular attention must be given. This is not intended to be an exhaustive list of all possible uses of the products, nor is it intended to imply that the uses listed may be suitable for the products.

- Outdoor use, uses involving potential chemical contamination or electrical interference, or conditions or uses not described in this manual.
- Nuclear energy control systems, combustion systems, railroad systems, aviation systems, medical equipment, amusement machines, vehicles, safety equipment, and installations subject to separate industry or government regulations.
- Systems, machines, and equipment that could present a risk to life or property.

Please know and observe all prohibitions of use applicable to the products.

NEVER USE THE PRODUCTS FOR AN APPLICATION INVOLVING SERIOUS RISK TO LIFE OR PROPERTY WITHOUT ENSURING THAT THE SYSTEM AS A WHOLE HAS BEEN DESIGNED TO ADDRESS THE RISKS, AND THAT THE OMRON PRODUCTS ARE PROPERLY RATED AND INSTALLED FOR THE INTENDED USE WITHIN THE OVERALL EQUIPMENT OR SYSTEM.

Disclaimers

CHANGE IN SPECIFICATIONS

Product specifications and accessories may be changed at any time based on improvements and other reasons.

It is our practice to change model numbers when published ratings or features are changed, or when significant construction changes are made. However, some specifications of the products may be changed without any notice. When in doubt, special model numbers may be assigned to fix or establish key specifications for your application on your request. Please consult with your OMRON representative at any time to confirm actual specifications of purchased products.

DIMENSIONS AND WEIGHTS

Dimensions and weights are nominal and are not to be used for manufacturing purposes, even when tolerances are shown.

PERFORMANCE DATA

Performance data given in this manual is provided as a guide for the user in determining suitability and does not constitute a warranty. It may represent the result of OMRON's test conditions, and the users must correlate it to actual application requirements. Actual performance is subject to the OMRON Warranty and Limitations of Liability.

ERRORS AND OMISSIONS

The information in this manual has been carefully checked and is believed to be accurate; however, no responsibility is assumed for clerical, typographical, or proofreading errors, or omissions.

Signal Words and Alert Symbols

• Meanings of Signal Words

For the safety operation of the V690-series RFID System, the signal word described below is used in this manual. Precautions given with this signal word are important for safety operation. Be sure to follow the precautions provided. The signal word and meaning are as follows:



Indicates a potentially hazardous situation which, if not avoided, will result in minor or moderate injury, or may result in serious injury or death. Additionally there may be significant property damage.

• Meanings of Alert Symbols



• Indicates a danger of explosion under particular conditions.

Alert Statements in this Manual



A lithium battery is contained in an ID Tag. Do not disassemble, deform under pressure, heat to above 212 °F (100°C), or incinerate the ID Tag. Otherwise serious injury may result from fire or rupturing of the battery.



Precautions for Safe Use

For safety, observe the following precautions.

1. Do not operate the product in any flammable, explosive, or corrosive gas environment.
2. Do not disassemble, repair, or alter the product.
3. Tighten the base lock screws and terminal block screws securely.
4. Use wiring crimp terminals of the specified size.
5. The 24 VDC power supply must meet the following conditions:
 - (1) The 24 VDC power supply must be used for the V690 Series only and must not be connected to any other devices or apparatuses.
 - (2) The voltage of the DC power supply must be within the specified ratings (24 VDC +10%/–15%).
6. Observe all precautions given in this manual.

Precautions for Correct Use

1. Do not install the V690-HMG01A, V690-D8KR01A, or V690-L01 in the following areas:
 - Areas exposed to the direct sunlight.
 - Humid areas where condensation may occur.
 - Areas subject to vibration or shock.
2. Preliminary Check of Installation Site

The V690 Series uses the 2,450 MHz frequency band for communications between the Antenna and Tags. Some wireless equipment, such as wireless LANs, cellular phones, personal handyphone systems and transceivers, motors, and switching power supplies, may generate radio waves (noise) that affect communications with the Tags. If you must use the product near such devices, check for negative influences in advance.

To minimize the general influence of noise, follow these precautions:

 - Ground any metallic material located around the product according to 100 Ω or less.
 - Wire the product separated as far as possible from high voltages and heavy currents.
3. Ambient Environment and Communications Range
 - The communications range depends on environment of the installation site. This is because metallic materials and the ground reflect radio waves, and water and the human body absorb it. Place an Antenna and Tag in the communications range and check the radio wave environment in advance.
 - The V690-HMG01A Read/Write Antenna has a communications test command to check the radio wave environment at the working site. (Refer to 4-5 *Communications Test*.)
4. Ground any ground terminal to 100 Ω or less. Performance may deteriorate if the system is not properly grounded.
5. Cleaning the V690-HMG01A, V690-D8KR01A, and V690-L01
 - Do not use any organic thinners. Resin materials and the case paint are dissolved by thinner.

Laws and Standards

1. Japan

The V690 is covered under the Specified Low-Power Wireless Station - Wireless Equipment for Mobile Object Identification (ARIB RCR STD-29 Version 3.2) and thus does not require a license for use in Japan.

2. USA

The V690 is covered under FCC Part 15 Subpart C and thus does not require a license for use in the USA.

FCC ID: E4E6CYCIDV6900101

The following restrictions apply for use in the USA:

The output power must be set to the low-power (2 m) mode. This is the default setting.

If the Antenna is set to the high-power (5 m) mode, it will be in violation of FCC regulations and subject to punishment.

3. Europe

The V690 is covered under the Radio and Telecommunications Terminal Equipment Directive 1999/5/EC (R&TTE Directive).

Radio wave Directives: EN 300 440-1 (2001-09)

EN 300 761-1 (2001-06)

EMC Directives: EN 300 440-1 (2001-09)

EN 300 761-1 (2001-06)

EN 301 489-1, -3 (2000-08)

A license is not required for use in the following countries.

Iceland, Ireland, England, Italy, Austria, the Netherlands, Greece, Switzerland, Spain, Denmark, Norway, Finland, France, Belgium, or Luxembourg.

The following restrictions apply for use in these countries:

Always use radio wave channel 5 for the Antenna. This is the default setting.

If the Antenna is set to any other radio wave channel, it will be in violation of the R&TTE Directive and subject to punishment.

4. Other Areas

Please ask your nearest OMRON representative.

Interference with Second-generation Low-power Data Communications Systems (Wireless LANs), Cellular Phones, etc.

1. Radio Interference between Wireless Stations

The 2,450 MHz frequency band (2,434.25 to 2,465.75 MHz) used by the V690 Microwave RFID System is designated for second-generation low-power data communications system (wireless LANs), local area wireless stations for mobile object identification, and specified low-power wireless stations, as well as industrial, scientific, or medical equipment, such as microwave ovens. Radio interference can be expected in this frequency band.

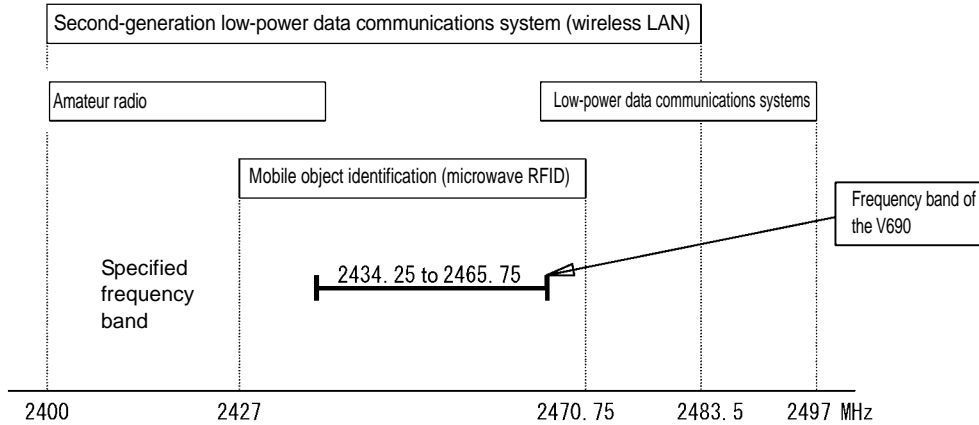

Note: Cellular phones and personal handyphone systems (900 to 1900 MHz) may also generate radio interference.

2. Possible Trouble Due to Radio Interference

• Communications Failure in RFID Systems

The radio waves from an ID Tag to the Antenna are weak and, therefore, communications between the Antenna and ID Tag may fail due to radio interference caused by any other devices. Keep sufficient distance between the RFID System and any other devices. For specific distances, refer to 8-5 *Distance to Wireless LAN Cellular Phone (Reference)*.

• ID Tag Battery Power Loss

The electronic circuits in the ID Tag may be started by radio waves from other device, causing the battery power to be consumed considerably. The V690 has a Tag power-saving function (refer to 4-7 *ID Tag Power-Saving Functions*) to control the battery power. Nevertheless, the battery power may be still consumed depending on the working environment. Keep sufficient distance between ID Tags and any other devices. For specific distances, refer to 8-5 *Distance to Wireless LAN Cellular Phone (Reference)*.

◆ Communications Failure in RFID System

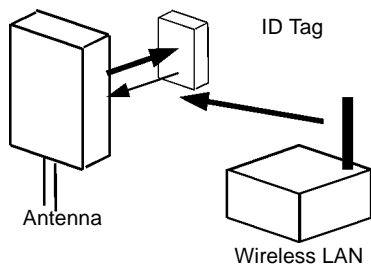

◆ ID Tag Battery Power Loss

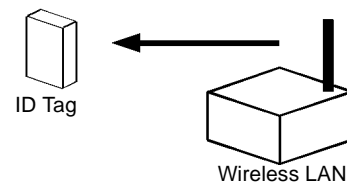

3. Preparations at the Working Site

(1) Checks at the Working Site

- 1) Before using the V690, check that second-generation low-power data communications systems (wireless LANs), local area wireless stations (Microwave RFID Systems) for mobile object identification, or specified low-power wireless stations (Microwave RFID Systems) are not operating near the V690.
- 2) If the V690 causes radio interference to a local area wireless station for mobile object identification, change the channel immediately or stop the V690 from emitting radio waves. Then, contact your nearest OMRON representative to take necessary actions to prevent interference (e.g., partitioning).
- 3) Contact your nearest OMRON representative if the V690 causes radio interference to the second-generation low-power data communications system or specified low-power wireless station for mobile object identification or if any other trouble happens.

(2) Product Label and Caution Label

A product label and caution label come with the product.

- Attach the product label to a visible position on the Antenna unit.
- Attach the caution label to a visible position near the Antenna. The caution label must show the contact address or phone number of the person in charge of installation and any other related information.

◆ Product Label



◆ Caution Label

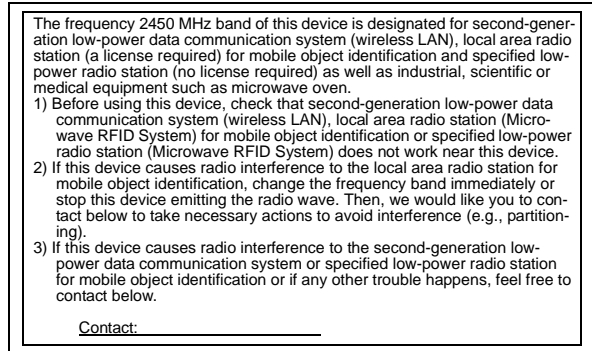

(3) Meaning of Product Label

- 2.4: Radio equipment that uses the 2.4 GHz frequency band
- RFID: The application of Radio Frequency Identification
- 10 mW: The Antenna power.
- □□□: Frequency band as follows:

The V690 Antenna uses the 2,450 MHz frequency band and, therefore “2450” is given.

Frequency band: 2440 2450 2455 MHz



Manual Revision History

A manual revision history code is added to the end of catalog number shown at the lower right of the front cover and back cover

Cat. No.	Z149-E1-02
-----------------	-------------------

↑
Revision code

Revision code	Date of revision	Reason for revision/Revised pages
01	October 2000	Original production
02	March 2004	Added sleep and standby time descriptions. Added information on overseas standards and overhauled the manual.

Contents

Chapter 1 Installation Precautions

1-1	Microwaves.....	1-1
1-1-1	V690 Frequency Bank: 2,450 MHz.....	1-1
1-1-2	Characteristics of Microwaves.....	1-2
1-1-3	Directional Characteristics of the Read/Write Head.....	1-5
1-1-4	ID Tags as Radio Wave Reflectors.....	1-6
1-2	Installation Procedure.....	1-7
1-2-1	Installation Flowchart.....	1-7
1-2-2	Determining V690 Application Methods.....	1-8
1-2-3	Programming the Host.....	1-11
1-2-4	Installation to the System.....	1-12
1-2-5	Confirming Communications with Tags.....	1-12
1-3	International Radio Wave Laws.....	1-14

Chapter 2 Features and System Configuration

2-1	Features.....	2-1
2-2	System Configuration.....	2-2
2-3	Operation Overview.....	2-4

Chapter 3 Specifications and Performance

3-1	H690-HMG01A Read/Write Antenna.....	3-1
3-1-1	Specifications.....	3-1
3-1-2	Dimensions.....	3-1
3-1-3	Connector Signals (Connector Enclosed).....	3-2
3-1-4	Indicators.....	3-2
3-2	V690-D8KR01A ID Tag.....	3-3
3-2-1	Specifications.....	3-3
3-2-2	Dimensions.....	3-3
3-2-3	Memory Map.....	3-4
3-2-4	Battery Life Characteristics.....	3-5
3-2-5	Battery Voltage Alarm Function.....	3-5
3-3	V690-L01 RS-422A/485 Link Unit.....	3-6
3-3-1	Specifications.....	3-6
3-3-2	Dimensions.....	3-6
3-3-3	Function.....	3-7
3-4	Connecting Cables.....	3-8
3-4-1	Specifications.....	3-8
3-4-2	Dimensions.....	3-8
3-5	Tag Communications Performance.....	3-10
3-6	Host Communications Specifications.....	3-11

Chapter 4 Functions

4-1	Single, FIFO, and Multi Mode Access	4-1
4-2	Switching between Low-power (2 m) and High-power (5 m) Mode	4-2
4-3	Radio Wave Channel Switching	4-3
4-4	Simplified Communications Test	4-4
4-5	Communications Test	4-5
4-6	Write Protect Function.....	4-6
4-7	ID Tag Power-Saving Functions.....	4-8

Chapter 5 Installation and Connection

5-1	Read/Write Antenna and ID Tag	5-1
5-1-1	Installation Environment	5-1
5-1-2	Installing the Antenna.....	5-2
5-1-3	Rainproofing the Antenna.....	5-3
5-1-4	Install Tags.....	5-4
5-1-5	Connecting the Cable to the Antenna	5-5
5-2	Wiring the Host.....	5-6
5-2-1	Wiring an RS-232C Interface	5-6
5-2-2	Wiring for RS-422A/485	5-9
5-3	Link Unit.....	5-14
5-3-1	Installation Environment	5-14
5-3-2	Installing Link Units	5-14
5-3-3	Wiring Link Units.....	5-15
5-3-4	Switch Settings	5-18

Chapter 6 Controlling Operation from the Host

6-1	Operation Status of Read/Write Antenna and ID Tags.....	6-1
6-2	Communications Operation Sequences	6-2
6-2-1	Communications Modes with Commands.....	6-2
6-2-2	Communications Modes with Communications Designations.....	6-5
6-2-3	Other Communications Modes	6-7
6-3	Command and Response Formats.....	6-8
6-4	Commands and Communications Designations	6-10
6-5	Data Code Designation	6-13
6-6	Communications Response Flow.....	6-15
6-7	Tag Communications Commands.....	6-16
6-7-1	Read.....	6-16
6-7-2	ID Code Read	6-18
6-7-3	Designated Tag Read.....	6-20
6-7-4	Write	6-22
6-7-5	Designated Tag Write	6-24
6-7-6	Data Fill	6-26
6-7-7	Designated Tag Data Fill.....	6-28

6-7-8	Communications Test	6-29
6-8	Antenna Operation Commands	6-30
6-8-1	Auto Repeat Cancel	6-30
6-8-2	Reset.....	6-31
6-8-3	Request to Respond	6-32
6-8-4	Request to Retransmit	6-33
6-9	Antenna Setting Commands	6-34
6-9-1	Radio Wave Transmission ON/OFF	6-34
6-9-2	Communications Range and Radio Wave Channel Selection	6-35
6-9-3	Radio Wave Output Status Read	6-36
6-9-4	Setting the Time to Wait for a Tag	6-37
6-9-5	Setting the Command Data Response Time	6-38
6-9-6	Read Data Length Setting	6-39
6-9-7	Setting Host Communications Conditions.....	6-40
6-9-8	Setting the Station Number	6-41
6-9-9	Reading Settings	6-42
6-10	End Code List	6-43

Chapter 7 Startup and Operating Procedures

7-1	Trial Operation.....	7-1
7-2	Diagnosis Function	7-2
7-3	Error List.....	7-3
7-4	Errors and Countermeasures	7-4
7-5	Maintenance and Inspection	7-5
7-6	Troubleshooting	7-6

Chapter 8 Communications Performance and Characteristic Data (Reference)

8-1	Communications Area (Reference).....	8-1
8-2	Influence of Ambient Temperature (Reference).....	8-2
8-3	Communications Time (Reference).....	8-3
8-4	Mutual Interference between Antennas (Reference)	8-5
8-5	Distance to Wireless LAN Cellular Phone (Reference)	8-6
8-6	Influence of Tag Installation Angle (Reference)	8-7
8-7	Influence of Back Metal (Reference).....	8-8

Appendix

Appendix 1	Glossary	Appendix-1
Appendix 2	JIS 8-bit Code List (ASCII List)	Appendix-4
Appendix 3	Degree of Protection.....	Appendix-5
Appendix 4	Standard Models	Appendix-6

Chapter 1 Installation Precautions

1-1 Microwaves

The V690-series Microwave RFID (radio frequency identification) System has a communications range between the Antenna and a Tag of up to 5 m. A Microwave RFID System, however, employs radio waves, and installation must be performed with care to ensure proper performance.

1-1-1 V690 Frequency Bank: 2,450 MHz

The frequency band of 2,450 MHz that is generally approved under law for use in microwave RFID systems is the same frequency band as used by microwave ovens. Under the law, microwaves are from 3,000 to 30,000 MHz and 2,450 is a submicrowave. Microwaves are transmitted by metal and in some application environments can be propagated for long distances. It is thus very import when setting up an application to use the Communications Test command and confirm the effects of the V690 Antenna and other wireless devices in the working site. (Section 4-5).

Frequencies and Wavelengths

RFID system	Frequency	OMRON products	Wavelengths (m)
Electromagnetic induction	125 kHz	V700	2,400
	530 kHz	V600	566
	13.56 MHz	V670, V720	22
Microwave propagation	2.45 GHz	V690	0.12

Wireless Devices that Operate in the 2.4 GHz Frequency Band:

- RFID Systems

- Wireless LANs: IEEE 802.11b, IEEE 802.11g

- Bluetooth

- Other original wireless devices

1-1-2 Characteristics of Microwaves

◆ Influence of External Objects

• Radio Wave Absorbers: Water, Human Body, Water Films, Water-absorbing Materials, etc.

Radio waves (microwaves) penetrates any solid body or liquid other than metal, but it is attenuated while penetrating. In particular, water absorbs radio waves extremely well. When radio waves penetrate water, the radio waves are absorbed considerably. Also, radio waves are attenuated remarkably in a human body, which contains much water. There must thus be no solid body or liquid between the Antenna and a Tag.

A general-purpose plastic or glass plate that is a few millimeters thick does not absorb radio waves, and radio wave attenuation is not a serious problem with these materials. However, the radio wave attenuation depends on a type of material and/or thickness of external objects which the radio wave penetrates. Perform a communications test in the working site in advance. If, however, the communication is performed through a plastic plate or glass plate that is wet or covered with water due to rain, the radio waves will be absorbed. The radio waves will be attenuated by the water film and the communication may fail. Perform a communications test in the working site in advance and take great care not to get out of the communications range during operation.

Dry wood and paper do not attenuate radio waves very much. Wood and paper, however, absorb water easily. Wet wood and paper may attenuate radio waves considerably. Perform a communications test in the working site in advance using both dry materials and wet ones.

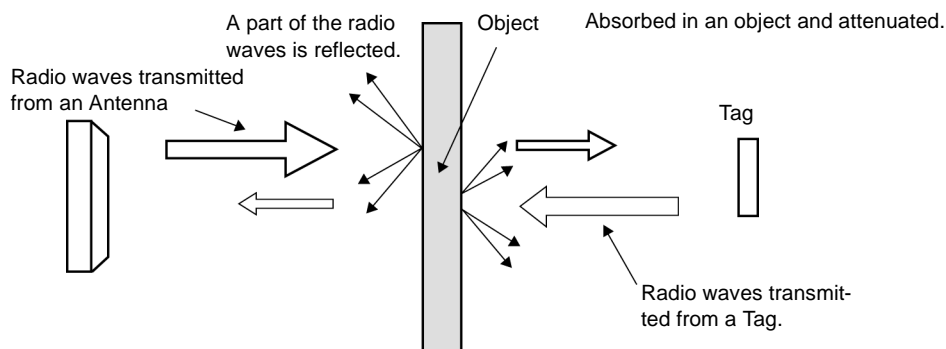

• Radio Wave Reflectors: Metal, Ground, Etc.

Metal reflects radio waves (microwaves) like a mirror reflects light. If there is a metal surface near an Antenna communications area, the communications area will be affected by the metal. If a metal object is placed between an Antenna and Tag, communications between the Antenna and Tag may fail. Metal, whether a metal plate or wire netting, may affect communications. Also, the ground affects the communications like metal.

As shown below, a radio wave absorber or reflector can be used to interrupt radio waves. When you interrupt radio waves, perform a communications test in the working site in advance.

Example of radio wave absorber: ECCOSORB AN75 (61 x 61 cm, E&C Engineering)

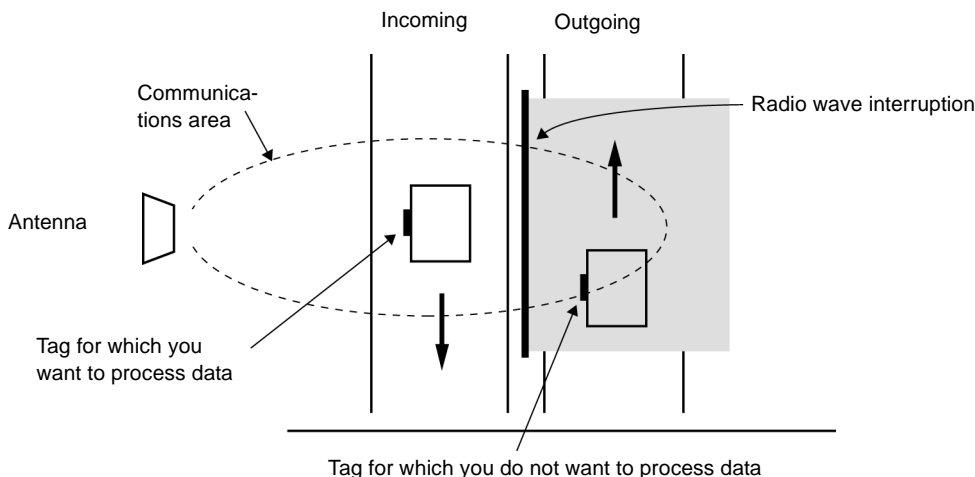

• Communications Area Affected by the Ground

If an Antenna is installed near the ground, radio waves (microwaves) emitted from the Antenna and ones reflected by the ground overlap each other. Therefore, the outline of the communications area becomes ragged and complex. In this case, dead zones may be formed frequently, where no communications can be made to a Tag.

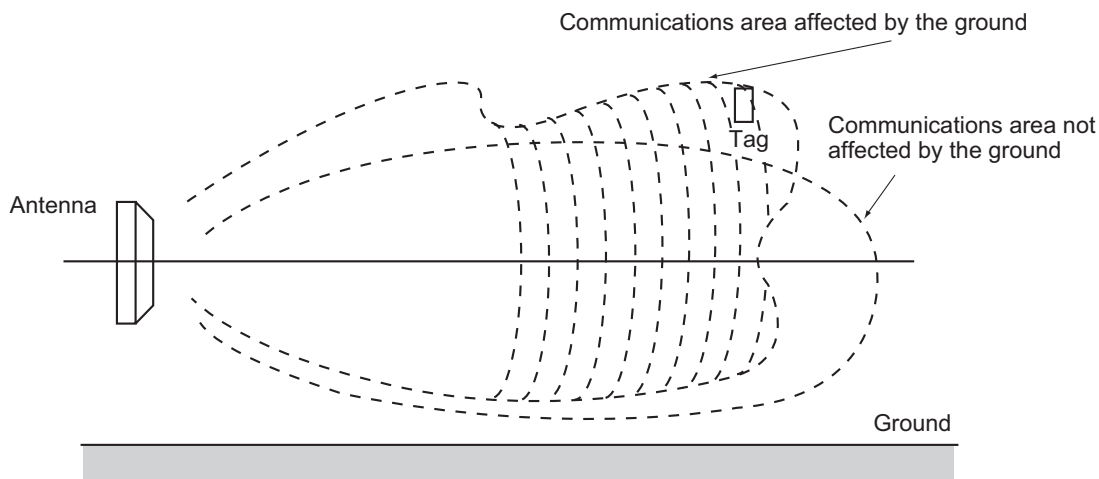
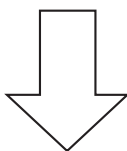
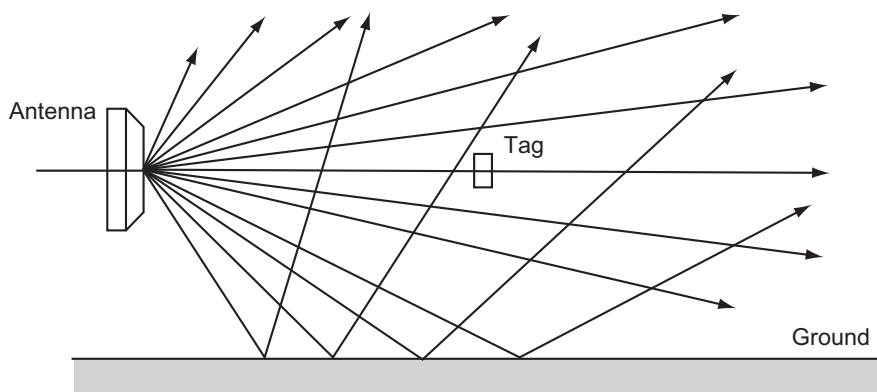

Precaution for Correct Use

Depending on the working site, a special point may be created in the communications area preventing communications with the Tag at that point. Be sure to check communications with a communications test (refer to Section 4-5).

◆ **Metal Propagation of Microwaves**

Microwaves will resonate in any metal that is an integral multiple of the wavelength of microwaves (122 mm) in length, causing the metal to act as an antenna. This “antenna” will cause the microwaves to be propagated in the metal a long way with little attenuation.

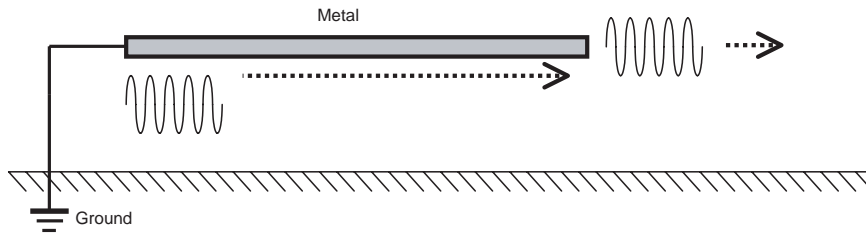

A V690 Antenna installed in a high location can affect Antennas installed far away when it transmits radio waves. If the is metal that will function as an antenna, the metal will cause the radio waves to be propagated a long way with little attenuation. In one actual example, a Read/Write Antenna installed more than 30 m away was affected.

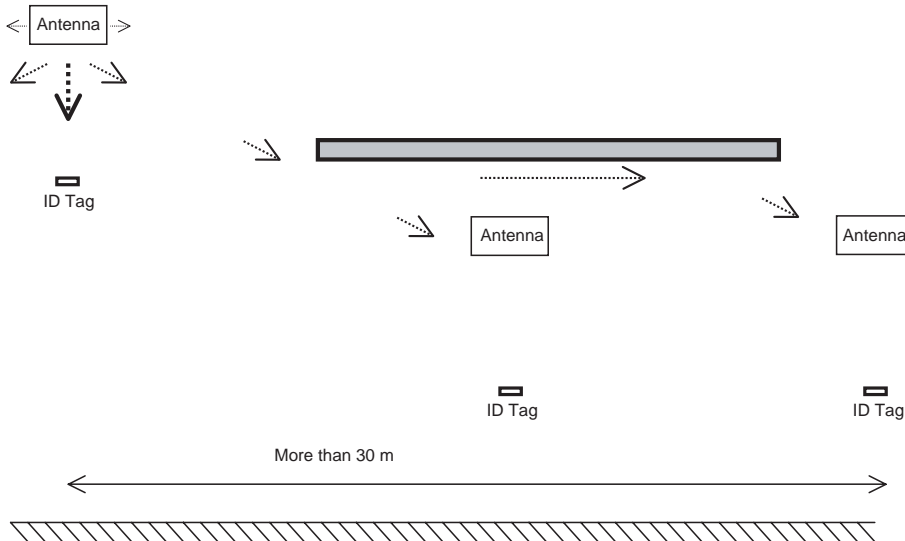

1-1-3 Directional Characteristics of the Read/Write Head

Cellular phones, wireless LANs, other common wireless devices must be able to communicate with other wireless devices within a specific area. They thus use nondirectional antennas and transmit radio waves in all directions.



Microwave RFID antennas, however, must communicate only with specific ID Tags. The Read/Write Antenna thus use directional radio waves to detect specific ID Tags. When the V690 Read/Write Antenna is set in low-power (2 m) mode, the oscillation power inside the Antenna is amplified to 4 mW, the directional antenna's gain goes to 14 dBi, and 100 mW is radiated. The radiation level from the back of the case is 1 mW maximum, a negligible level.

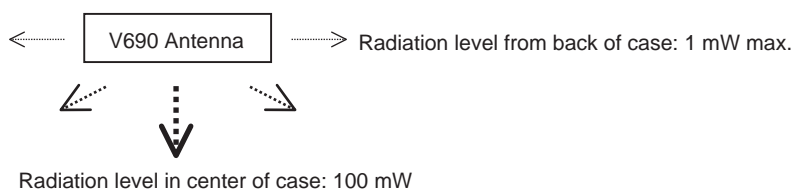

1-1-4 ID Tags as Radio Wave Reflectors

Regardless of whether a microwave system or a electromagnetic induction system is used, the ID Tags in common RFID systems are transponders. The ID Tags do not transmit radio waves themselves, but rather they transmit data by reflecting the radio waves from the Read/Write Antenna. The Read/Write Antenna can communicate with ID Tags in the communications area because the ID Tags act as reflectors. Also, the battery built into an ID Tag is not used to transmit radio waves, but only for the operation of the electronic circuits inside the Tag (e.g., static-RAM memory and the CPU). The battery in an ID Tag thus has a long life of 5 years (reference value). The operation of an ID Tag as a reflector also makes them very sensitive. When the V690 Antenna and ID Tag are separated by only 1 m, the ID Tag returns only one part in one hundred million of the radio wave level output by the Antenna. If the V690 is set to the low-power (2 m) mode, the power of the radio waves received by the Antenna at a distance of 1 m is only 1 nW. The V690 uses subcarrier technology to perform modulation at frequencies lower than 2,450 MHz and create a structure resistant to noise from other wireless devices in the 2.4 GHz band, but it is still more susceptible to noise in the 2.4 GHz band than common wireless devices.

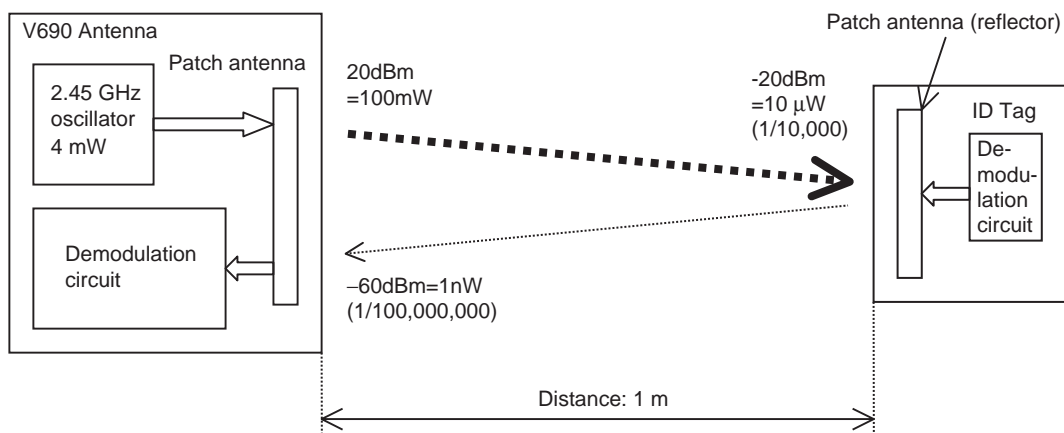

1-2 Installation Procedure

1-2-1 Installation Flowchart

The following flowchart shows the procedure to introduce a V690 System.

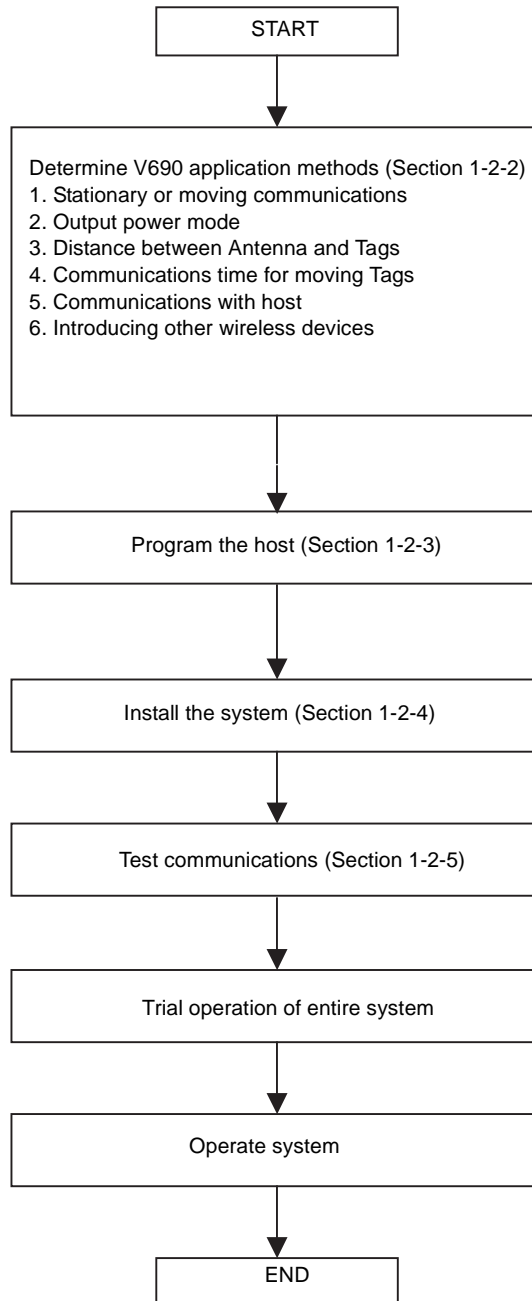

Refer to the following sections for further information:

1-2-2 Determining V690 Application Methods

1-2-3 Programming the Host

1-2-4 Installation to the System

1-2-5 Confirming Communications with Tags

1-2-2 Determining V690 Application Methods

Consider the information provided in this section when determining the applications methods of the V690.

(1) Communications with Stationary or Moving Tags

ID Tags are attached to product, pallets, or other object and then communications are performed with the Read/Write Antenna. It makes an important difference whether communications are performed with ID Tags when they are stationary or when they are moving. Decide which is the best method after proper consideration.

---	Communications with stationary ID Tags	Communications with moving ID Tags	
	Objects are detected with sensors and then the host sends a command to the Antenna.	Objects are detected with sensors and then the host sends a command to the Antenna.	Objects are not detected and Auto or Repeat command is used.
Communications reliability	Acceptable If communications fail due to noise, retries can be performed to increase reliability. There may be, however, areas in which communications are not possible or distorted due to the effects of reflections or other factors.	Acceptable If communications fail due to noise, retries may not be possible if the Tag has left the communications area, possibly affecting the entire system. Some means of recovery must be used when communications fail. Even if there are areas in which communications are not possible due to the effects of reflections or other factors, the movement of the Tags through the communications area will enable communications.	
System cost	Acceptable Sensors are required detect objects, increasing the system cost by the cost of the sensors.	Acceptable Sensors are required detect objects, increasing the system cost by the cost of the sensors.	Good Sensors are not required to detect objects.
Effect on other V690 Antennas or other wireless devices	Good The effects will be relatively small because the Antenna will transmit radio waves only when communicating. The effects, however, will have to be checked in the working site.		NG The system will be affected greatly because radio waves are being transmitted constantly.

Note 1: Command types: Trigger, Auto, and Repeat (Refer to 6-2-1.)

Note 2: See the illustration at the right for one means of detecting objects.

Note 3: As one example of a means to recover when communications fail, two Antennas can be used. If communications with the first Antenna fail, they can be performed from the second Antenna, as shown in the following illustration.

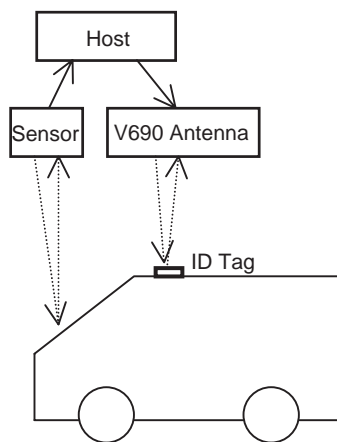
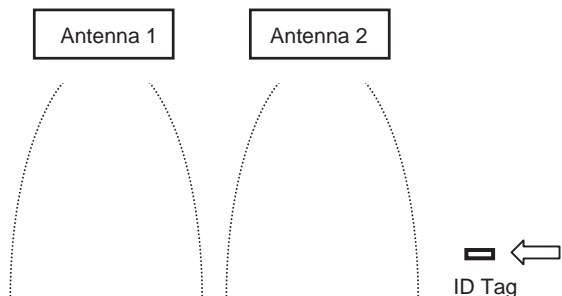

(2) Selecting the Output Power Mode

The “5 m” given for the high-power output power mode is the maximum communications range. The distance between the Read/Write Antenna and ID Tag must be, under normal circumstances, less than 5 m. Using the high-power mode increases the output power, increasing the radio waves reflected from the surroundings, which can in turn reduce the communications distance or even enable communications in unlikely locations. The low-power (2 m) mode should be used whenever possible to reduce affecting other devices. The low-power (2 m) mode is the default setting.

Output power mode	Low-power (2 m) mode	High-power (5 m) mode
Radio wave output from Antenna	4 mW	10 mW
Distance between Antenna and Tag at room temperature	2 m max.	3.5 m max.
Installation distance between two V690 Antennas installed in parallel	4.5 m min. (See note.)	6 m min. (See note.)

Note: The parallel installation distances of 4.5 and 6 m minimum given above assume that there is no radio wave reflection. Any metal in the surrounding area will affect the installation distance. It may be necessary to program the system so that adjacent Antennas do not transmit at the same time or so that they use different radio wave channels.

(3) Distance between Read/Write Antenna and ID Tags

The communications distance can be calculated as shown below when there is no metal near the Read/Write Head or ID Tag.

Conditions:

Low-power (2 m) mode

Tag installation angle: $\pm 15^\circ = -15\%$ max.

Metal behind Tag at 0 mm: -10% (from Section 8-7)

The distance will be set to 70% of the maximum communications distance.

Calculation:

$$2.0 \text{ m} \times (1 - 0.15) \times (1 - 0.10) \times 70\% = 1.0 \text{ (m)}$$

The width of the communications for each Antenna can be affected by metal at the working site. Always perform communications tests to measure the radio wave environment value and check for radio wave interference at the working site.

(4) Time for Communications with Moving Tags

A calculation example for the speed of Tag movement is provided in Section 8-3. Here, the time available for communications will be calculated.

Conditions:

Low-power (2 m) mode

Distance between Tag and Antenna: 1.5 m

Width of communications area at 20°C: 800 mm (from Section 8-1)

Tag speed: 100 mm/s

Tag rotation: 0° to 360°

Tag installation angle: $\pm 15^\circ = -15\%$ max.

Metal behind Tag at 5 mm: -5% (from Section 8-7)

Calculation:

$$800 \div 100 \times (1 - 0.15) \times (1 - 0.05) = 6.5 \text{ s}$$

The system would be designed to complete communications well within 6.5 s to allow for a margin for error. The communications time required to read 8 Kbytes is 260 ms (from Section 8-3), which provides plenty of margin.

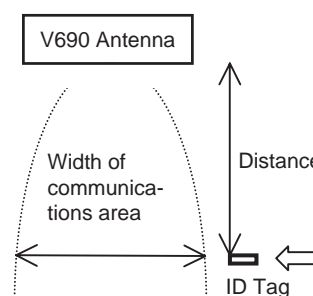

(5) Communications between Read/Write Antenna and Host

With the V690 Series, either RS-232C or RS-422A/RS-485 can be used for communications between the Read/Write Antenna and the host. Select the type of communications based on the required baud rate and length of the communications path.

Protocol	RS-232C	RS-422A/RS-485
Baud rate	19.2 kbps max.	115.2 kbps max.
Path length	15 m max.	300 m max.

Note 1: Whenever possible, use the BCC as a check code for communications between the Read/Write Antenna and the host, particularly if the baud rate is above 20 kbps.

Note 2: Specify the data length to use when returning data from the Read/Write Antenna to the host. Refer to Section 6-9-6. Keep the data length as short as possible to help improve the reliability of data communications.

(6) Introducing Other Wireless Devices

It is not recommended to use wireless LANs or other wireless devices that operate in the 2.4 GHz band in the same building as the V690. OMRON cannot assume responsibility for such applications. If such applications are unavoidable, observe the following precautions.

Do Not Use FHSS Wireless Devices

Do not use FHSS (frequency hopping spread spectrum) systems or Bluetooth systems. Use DSSS (direct sequence spread spectrum) systems (wireless LAN IEEE 802.11b) or other frequency bands (e.g., the 400 MHz band).

Post Warnings

Post warnings asking for caution in using wireless devices, such as wireless LAN or Bluetooth systems, because an RFID system using the 2.4 GHz band is being operated.

1-2-3 Programming the Host

Observe the following precautions when programming the host (e.g., Programmable Controller or personal computer).

Retries

Perform retries by sending the same command after a delay of 10 ms whenever the end code in the response from the Read/Write Antenna is 72 (no Tag) or 70 (communications error with Tag).

Executing Multiple Commands

For example, when executing a read followed by a write, wait at least 200 ms after receiving a normal response (00) for the read command before executing the Write command. The ID Tag will sleep for at least 200 ms.

Writes with Verification

To increase the reliability of writing, use Write commands with verification (W1, W4, or W7) whenever possible.

End Code 7B

An end code of 7B is a warning indicating that the voltage of the battery in the ID Tag has dropped. Record the ID code of the ID Tag for which an end code of 7B was returned and have the battery replaced. If the ambient temperature is 0°C or lower, an end code of 7B may be returned even if the battery has sufficient charge. End codes of 7B can generally be ignored if the temperature is 0°C or lower.

Communications Log

Keep a log of commands and responses between the Read/Write Antenna and ID Tags to help in troubleshooting any problems that might occur. At the very least, keep a log of end codes and ID codes.

Discontinuing Auto Repeat Commands

When communications have been completed for Auto Repeat Commands, be sure to send the Auto Repeat Clear command (C2) to stop transmission of radio waves. This is necessary to reduce the time that radio waves are transmitted and thus reduce the effects on other Antennas.

Number of Read/Write Bytes

Communications between the Read/Write Antenna and an ID Tag are performed in units of 256-byte packets. Even if the required number of read bytes is only 2 kbytes, program structure, such as the use of common program sections, may call for 8-kbyte reads. Whenever possible, however, read/write only the required number of bytes to increase the stability of communications.

Errors in Host Communications

Read commands are sent to the Read/Write Antenna, which returns a response. If an error occurs in host communications, it is not always necessary to send the same command again. The Request to Retransmit command (H1) can be sent to read the response again.

End Code 70 for Writes

If an end code of 70 is returned for a Write command, it is possible that the specified write address in the ID Tag was corrupted and that the data was written to the wrong address. Take steps in programming to handle this possibility.

1-2-4 Installation to the System

Observe the following precautions when installing the Read/Write Antenna.

Installation Direction

Install the Antennas in a consistent direction to enable easier maintenance.

Operation Indicators

The operation of the Antenna can be monitored using the four indicators provided on it. This will aid in maintenance work. Install the Antenna so that the indicators are easily visible.

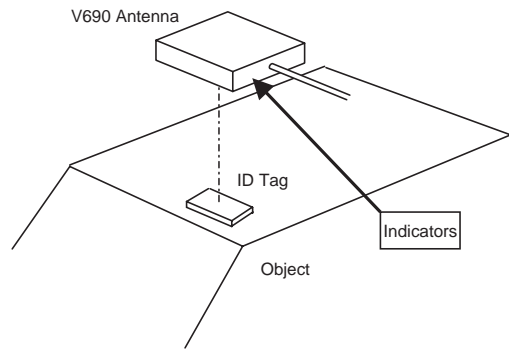

1-2-5 Confirming Communications with Tags

◆ Confirmation for Overall System

The width of the communications for each Antenna can be affected by metal at the working site. Always perform communications tests to measure the radio wave environment value and check for radio wave interference at the working site.

Evaluating Communications Performance for Individual V690 Antennas

With the line stopped, use the Communications Test command (T0) and the commands that will actually be used to confirm the range in which communications are possible for each V690 Antenna. Set up the system so that the radio wave environment value is 50 or less.

Influence from Other V690 Antennas

Set any V690 Antennas that might influence operation so that they are transmitting radio waves and then repeat the above evaluation.

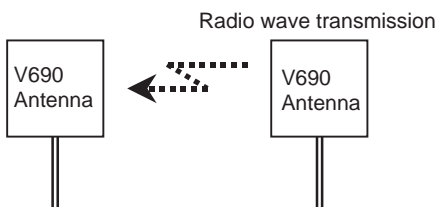
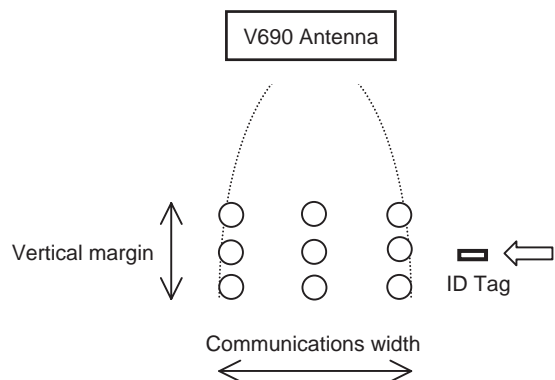

◆ Countermeasures for High Radio Wave Environment Values

Perform tests using the Communications Test command and maintain a radio wave environment value of 50 or less. Stable operation will not be possible if the radio wave environment value is greater than 50. If the value cannot be reduced below 50, take the following measures.

High Radio Wave Environment Values for Individual V690 Antennas

- Adjust the distance between the Read/Write Antenna and ID Tags or adjust positioning.
- Remove as many metallic objects as possible to reduce the effects of metal.

High Radio Wave Environment Values Due to Other V690 Antennas

- Do not transmit radio waves from adjacent Antennas at the same time.
- Set the radio wave channels to 0, 5, and 9.

The V690 supports 10 channels of radio wave frequencies from channel 0 to channel 9. These can be used to reduce interference with other wireless devices. For adjacent V690 Antennas, however, only three channels can be used, i.e., 0, 5, and 9 (default: 5). This is because of the high-speed communications (600 kbps) of the V690, which requires that the channels of adjacent Antennas be separated by at least 4 channels.

Channel	0	1	2	3	4	5	6	7	8	9
Frequency (MHz)	2437.5	2440.0	2442.5	2445.0	2447.5	2450.0	2452.5	2455.0	2457.5	2460.0

Note: Only channel 5 can be used in Europe. It is thus not possible to use different channels to prevent interference, so adjust the timing of transmitting radio waves instead.

◆ Testing Communications with Tags

Test Mechanism

One packet (256 bytes) is sent from the Read/Write Antenna to the ID Tag. The ID Tag returns 256 bytes to the Antenna to complete the first cycle. In the communications test, this cycle is repeated 256 times, meaning that approximately 65 Kbytes of data is handled during one communications test. Approximately 2.5 s is required to complete the test.

The Read/Write Antenna uses a CRC (cyclic redundancy check) code to check the data and determines if each cycle is OK or NG. The NG count is returned as the radio wave environment value. The radio wave environment value is between 0 and 256.

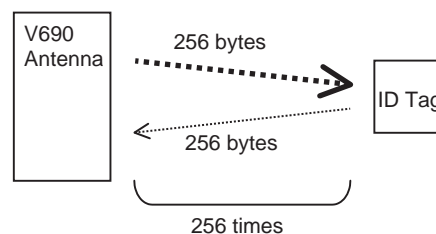

Application Method

Send the Communications Test command (T0) from the host to the Read/Write Antenna. Refer to Section 6-7-8 for the command and response formats. The radio wave environment value may vary depending on the timing. Repeat the test at least five times for each position of the Read/Write Antenna and ID Tag and use the average value.

Radio Wave Environment Values (Example)

---	Radio wave environment value
1	10
2	3
3	5
4	50
5	12
Average	16

1-3 International Radio Wave Laws

Laws governing the use of radio waves are different in different countries. The output power modes and radio wave channels that can be used thus depend on the country where the Microwave RFID System is used.

◆ Japan

The V690 falls under the frequency band from 2,434.5 to 2465.75 MHz stipulated in the Specified Low-Power Wireless Station - Wireless Equipment for Mobile Object Identification (RCR STD-29). Each Antenna is issued a Technical Regulation Conformity Certification by the Telecom Engineering Center (<http://www.telec.or.jp/>) before shipping. Within Japan, either the low-power (2 m) or high-power (5 m) mode can be used and any of the radio wave channels from channel 0 to channel 9 can be used.

Radio wave channel (MHz)		0 (2437.5)	1 (2440.0)	2 (2442.5)	3 (2445.0)	4 (2447.5)	5 (2450.0)	6 (2452.5)	7 (2455.0)	8 (2457.5)	9 (2460.0)
Output power mode	Low (2 m)	OK	OK	OK	OK	OK	OK	OK	OK	OK	OK
	High (5 m)	OK	OK	OK	OK	OK	OK	OK	OK	OK	OK

◆ USA

The V690 conforms to FCC 15.245 of the FCC (<http://www.fcc.gov/>). In FCC 15.245, however, 500 mV/m is specified as the fundamental wave electric field strength. The high-power (5 m) mode thus cannot be used. Within the USA, only the low-power (2 m) mode can be used, but any of the radio wave channels from channel 0 to channel 9 can be used.

(If the Antenna is set to the high-power (5 m) mode, it will be in violation of FCC regulations and subject to punishment.)

Radio wave channel (MHz)		0 (2437.5)	1 (2440.0)	2 (2442.5)	3 (2445.0)	4 (2447.5)	5 (2450.0)	6 (2452.5)	7 (2455.0)	8 (2457.5)	9 (2460.0)
Output power mode	Low (2 m)	OK	OK	OK	OK	OK	OK	OK	OK	OK	OK
	High (5 m)	No	No	No	No	No	No	No	No	No	No

◆ Europe

In the EU, an application must be made according to the Radio and Telecommunications Terminal Equipment Directive 1999/5/EC (R&TTE Directive). The V690-HMG01A complies with Radio Wave Directives EN 300 440-1 and EN 300 761-1, EMC Directives EN 301 489-1, -3, and Safety Directive EN 61010-1.

At present, laws regarding radio waves vary with the country, although the laws are scheduled to be revised to respect the ERC Recommendation 70-03 E for short-distance wireless devices (including RFID systems). The V690 conforms to specification in *Annex II: RF Identification Systems* in this Recommendation, but the frequency range is limited to 2,446 to 2,454 MHz. The V690 can thus be used only when set to radio wave channel 5. Within the EU, only radio wave channel 5 can be used, but either the low-power (2 m) or high-power (5 m) mode can be used.

(If the Antenna is set to any radio wave channel other than channel 5, it will be in violation of the R&TTE Directive and subject to punishment.)

Radio wave channel (MHz)		0 (2437.5)	1 (2440.0)	2 (2442.5)	3 (2445.0)	4 (2447.5)	5 (2450.0)	6 (2452.5)	7 (2455.0)	8 (2457.5)	9 (2460.0)
Output power mode	Low (2 m)	No	No	No	No	No	OK	No	No	No	No
	High (5 m)	No	No	No	No	No	OK	No	No	No	No

Note: Refer to *Laws and Standards* at the front of this manual for a list of countries where the V690 can be used.

Chapter 2 Features and System Configuration

2-1 Features

The V690 Series is a Microwave RFID System that achieves long-range, high-performance communications. The V690 System is highly suited for assembly lines, physical distribution systems, and product control applications.

V690-HMG01A
Read/Write Antenna

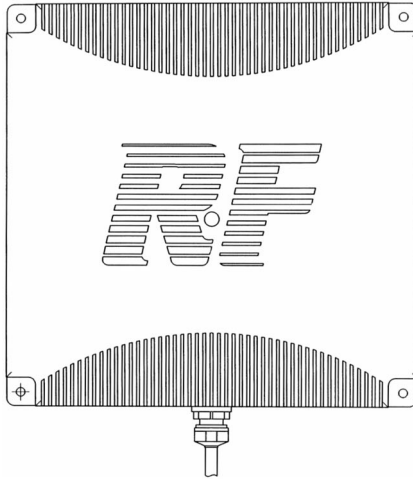

V690-D8KR01A
ID Tag

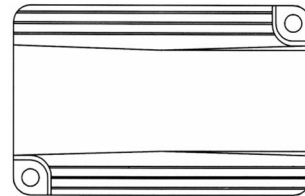

V690-L01
RS-422A/485 Link Unit

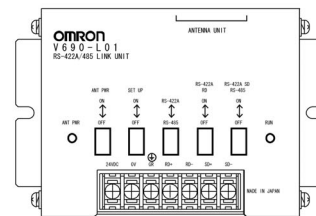

(1) V690-HMG01A Read/Write Antenna

- Consists of an antenna unit, which communicates with ID Tags, and a controller unit, which controls communications.
- The antenna unit achieves a communications speed of 600 kbps and a maximum communications range of 5 m.
- The Antenna uses circularly polarized waves as radio waves. An ID Tag facing the Antenna can communicate at any angle of rotation on the center axis. The maximum communications range depends on the angle of the Tags.
- This Antenna is a specified low-power wireless station and, therefore, no wireless station license is required for use in Japan.
- A Multi Access function enables accessing several Tags in the Antenna communications area and a FIFO (First-In First-Out) function enables accessing Tags coming in the communications area sequentially one by one.
- Commands from the host can be used to switch the output power mode (communications range) between the low-power (2 m) and high-power (5 m) mode, or to switch the radio wave channel at the working site. You can select the most suitable output power mode at the working site to easily prevent mutual interference between Antennas.
- The controller unit supports an RS-232C interface. It can connect to a general-purpose personal computer or Programmable Controller (PLC) that supports RS-232C communications. Also, several Antennas can be connected to one host using the RS-422A/485 Link Unit.
- A simplified communications test function, which can check communications with Tag without a host, and a communications test, which can check the radio wave environment at the working site, are also supported.

(2) V690-D8KR01A ID Tag

- This Tag contains a battery and have a memory capacity of 8 kbytes.
- Write Protection is supported to disable writing in using of 256 bytes.
- An IEC IP67 (JEM IP67g) protective structure has been achieved. This Tag can be used even in a place subject to water and oil splashes.
- The battery life is 5 years at 25°C (reference value). The battery is not replaceable, but a power-saving function and battery voltage alarm function are supported.

(3) V690-L01 RS-422A/485 Link Unit

- Use when communicating with the host through RS-422A or RS-485 communications.
- The power supply to the Read/Write Antenna can be controlled, the operation/setting mode can be switched, communications can be switched between RS-422A and RS-485, and the terminating resistance can be turned ON/OFF.

2-2 System Configuration

- **Example System Configuration for the V690-HMG01A: 1:1 Host Connection via RS-232C**

The V690-HMG01A supports an RS-232C serial interface and can connect to a general-purpose personal computer or Programmable Controller easily. All communications with Tags are controlled according to commands from the host.

Host

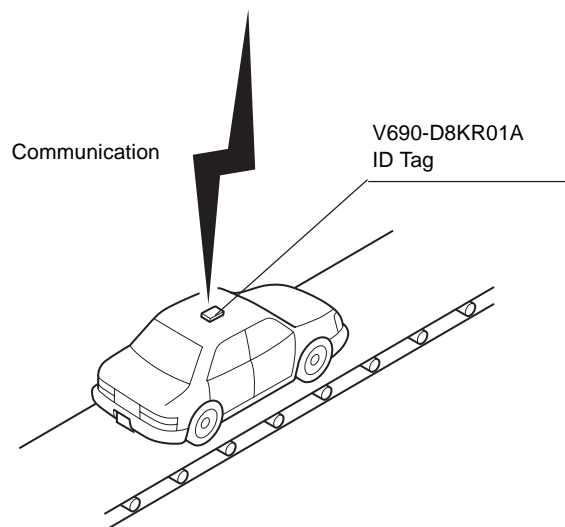
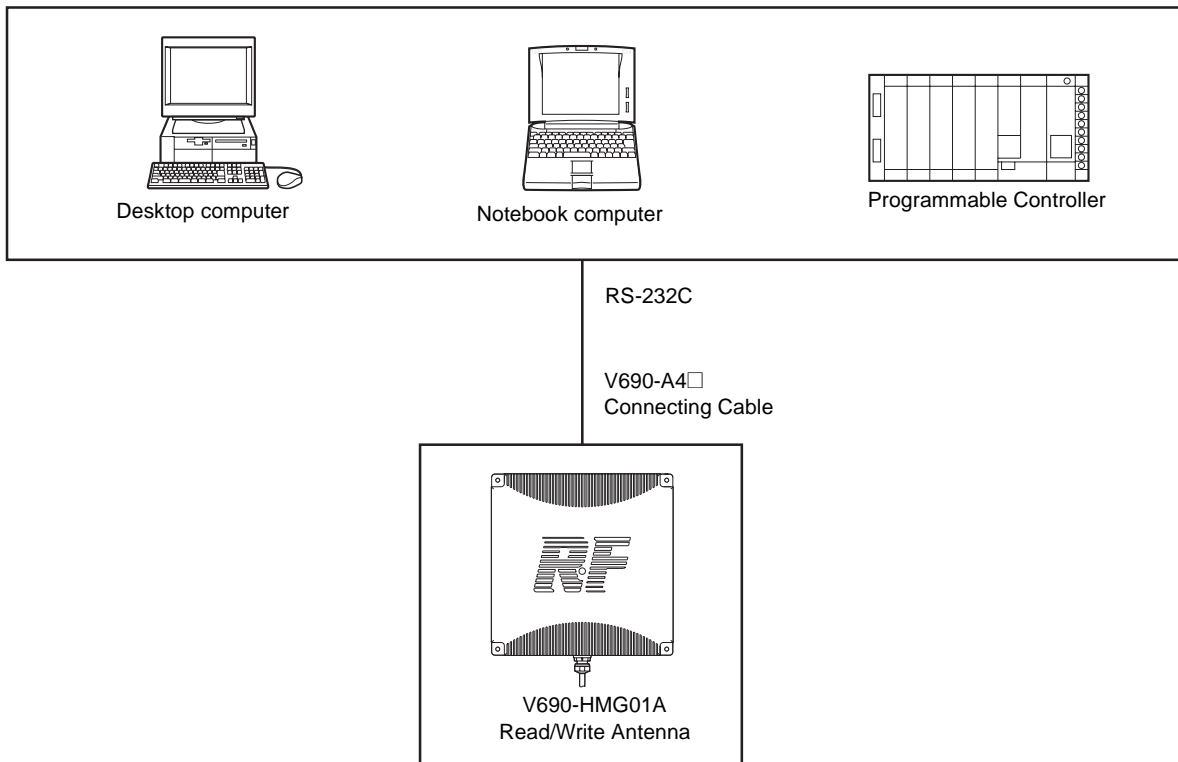

• **Example System Configuration for the V690-HMG01A: 1:N Host Connection via RS-422A (4-wire)/RS-485 (2-wire)**

The V690-HMG01A supports an RS-422A/485 interface and up to 32 V690-HMG01A Antennas can connect to one general-purpose personal computer or Programmable Controller through up to 32 V690-L01 RS-422A/485 Link Units. The maximum length of RS-422A/485 cable is 300 m.

Host

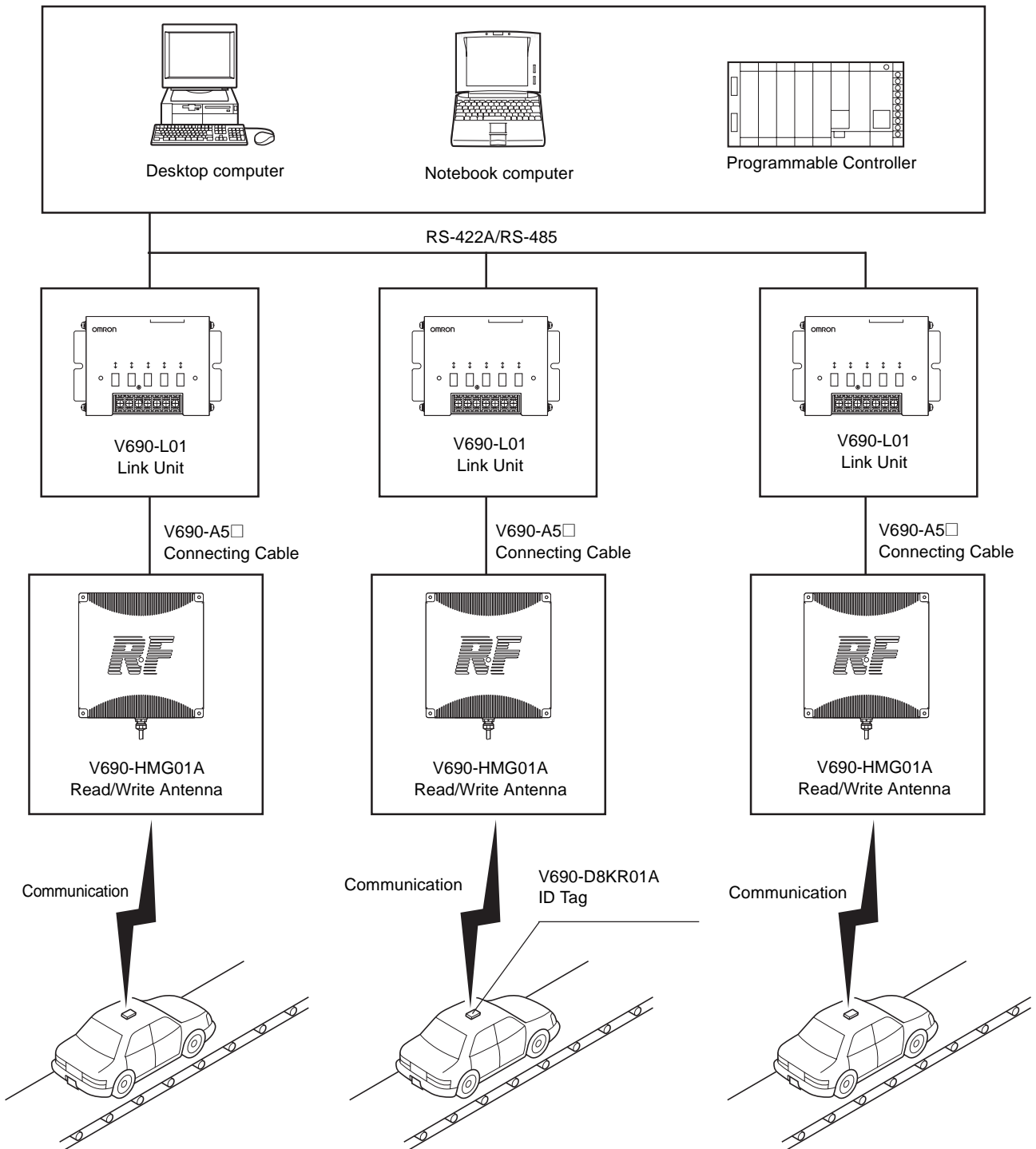

2-3 Operation Overview

An overview of V690 Series operation is provided below using assignments of destination in car transportation.

An ID Tag is mounted on the car body and the destination is assigned to the car according to the destination information stored in the ID Tag.

Host

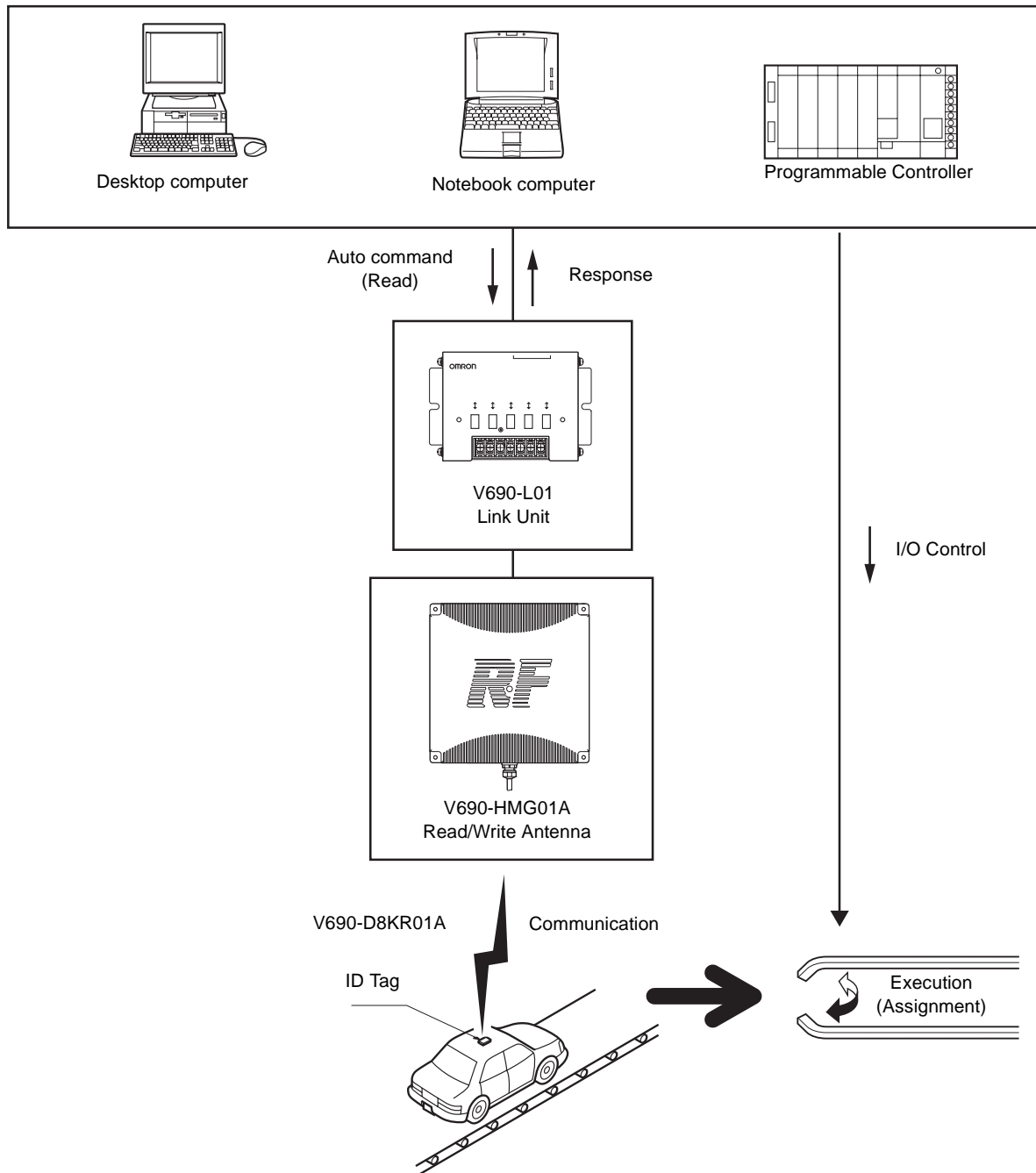

- (1) When an auto command is sent from the host to the Read/Write Antenna, the Antenna becomes ready to work and waits for an ID Tag.
- (2) When an ID Tag enters the Antenna's communications area, the Antenna reads data from the ID Tag and returns the data from the memory area specified in the auto command (Read) as a response.
- (3) Based on the data, the host controls a transportation device and assigns the destination for the car.

Chapter 3 Specifications and Performance

3-1 H690-HMG01A Read/Write Antenna

3-1-1 Specifications

Item	Specifications
Emitting frequency	2,450 MHz band (2,434.25 to 2,465.75 MHz)
Power supplied to Antenna	5 mW in low-power (2 m) mode, 10 mW in high-power (5 m) mode (The system is thus classified as a specified low-power wireless station - wireless equipment for mobile object identification in Japan. The user is not required to apply for a license for a wireless station in Japan for this type of system.)
Power supply	24 VDC +10%/–15%
Consumption current	0.5 A max.
Ambient operating temperature	-20 to 60°C (with no icing)
Ambient operating humidity	35% to 85% (with no condensation)
Ambient storage temperature	-20 to +60°C (with no icing)
Ambient storage humidity	35% to 85% (with no condensation)
Insulation resistance	20 MΩ min. (at 100 VDC) between the cable terminals as a group and the case
Withstand voltage	1,000 VAC, 50/60 Hz for 1 minute, detected current of 1 mA or less between the cable terminals as a group and the case
Degree of protection	IP62 (IEC60529) *With the cable outlet turned downward.
Vibration resistance	10 to 150 Hz, single amplitude 0.35 mm, maximum acceleration 50 m/s ² sweeping 10 times for 8 minutes in X, Y, and Z directions
Shock resistance	150 m/s ² three times each in X, Y, and Z directions, i.e., 18 times total
Indicator	Power supply, radio wave emission, host transmission, Tag transmission
Cable length	0.5 m (A round connector (watertight) comes with the cable.)
Weight	2.6 kg max. (including a cable of 0.5 m in length and connector)

3-1-2 Dimensions

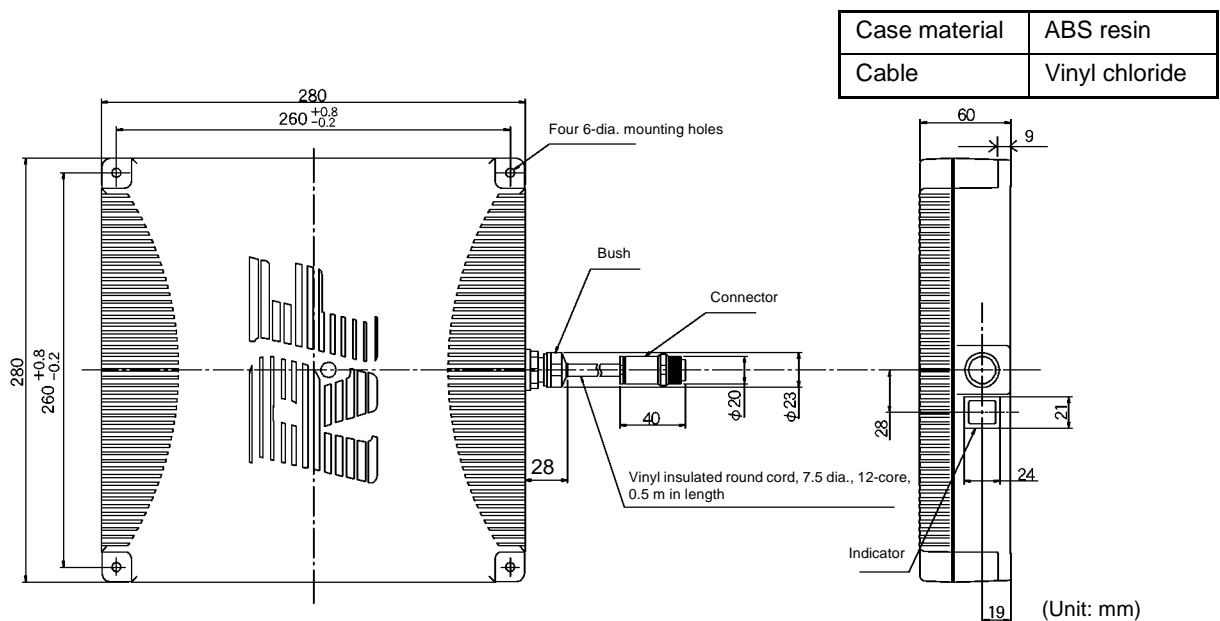

Precaution for Correct Use

The degree of protection of the Antenna (IP62) provides protection against drops of water. If the Antenna is subjected to water spray or a water jet, cover the Antenna with a protective cover. (Refer to Appendix 3 Degree of Protection.)

3-1-3 Connector Signals (Connector Enclosed)

Item	Symbol	Pin number	Usage
Power supply	+24V	A	Supply 24 VDC.
	0V	B	
Setting	+P	C	Short-circuit for setting mode. Refer to Section 6-1. This pin is not connected in operation mode.
	-P	D	
RS-422A RD (Receiving)	RD+	E	Use for RS-422A communications. (Terminating resistance 220 Ω is connected to both RD and SD in the Antenna.) Do not connect when RS-232C is used.
	RD-	F	
RS-422A SD (Sending)	SD+	G	
	SD-	H	
RS-232C Receiving	Rx	J	Use for RS-232C communications. Do not connect when RS-422A/485 is used.
RS-232C Sending	Tx	K	
RS-232C Signal 0 V	SG	L	
Frame ground	GR	M	Ground to 100 Ω or less.

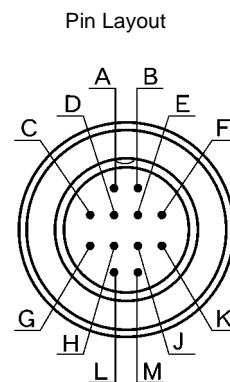

3-1-4 Indicators

(1) The following items can be checked through the Antenna indicators.

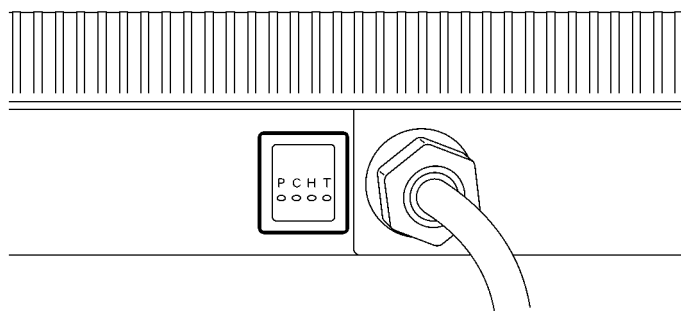

Indicator	P (green)	C (red)	H (yellow)	T (green)
Meaning	Power supply	Radio wave emission	Host transmission	Tag transmission

- P (Power): Lights when 24 VDC power is being supplied to the Antenna.
- C (Carrier): Lights when the Antenna is emitting radio waves.
- H (Host): Lights when the Antenna is sending data to the host.
- T (Tag): Lights when the Antenna is sending data to a Tag.

- (2) By enabling the setting mode, you can check the communications range for Tags without connecting the host. Refer to Section 4-4.
- (3) If operation fails, troubleshoot according to these indicators, which will light or flash to indicate the cause of the problem. Refer to Section 7-2.

Precaution for Correct Use

Do not disassemble the Antenna or touch the inside when the power supply is turned ON. Otherwise, the Antenna may fail.

3-2 V690-D8KR01A ID Tag

3-2-1 Specifications

Item	Specifications
Memory capacity	8 Kbytes
Type of memory	SRAM (volatile memory). Data is backed up by a battery.
Battery life (Reference value)	5 years *At an ambient temperature of 25°C. For details, refer to Section 3-2-4. The battery is not replaceable. There is a battery voltage alarm function.
Ambient operating temperature	-20 to 60°C during communications, -25 to 70°C otherwise (with no icing)
Ambient operating humidity	35% to 85% (with no condensation)
Ambient storage temperature	-25 to 70°C (with no icing)
Ambient operating humidity	35% to 85% (with no condensation)
Degree of protection	IP67 (IEC60529) and IP67g (JEM1030)* When mounted on a flat surface without any level difference.
Vibration resistance	10 to 2,000 Hz, single amplitude 0.75 mm, maximum acceleration 150 m/s ² sweeping 10 times for 15 minutes in X, Y, and Z directions
Shock resistance	500 m/s ² 3 times each in X, Y, and Z directions, i.e., 18 times total
Weight	75 g max.

3-2-2 Dimensions

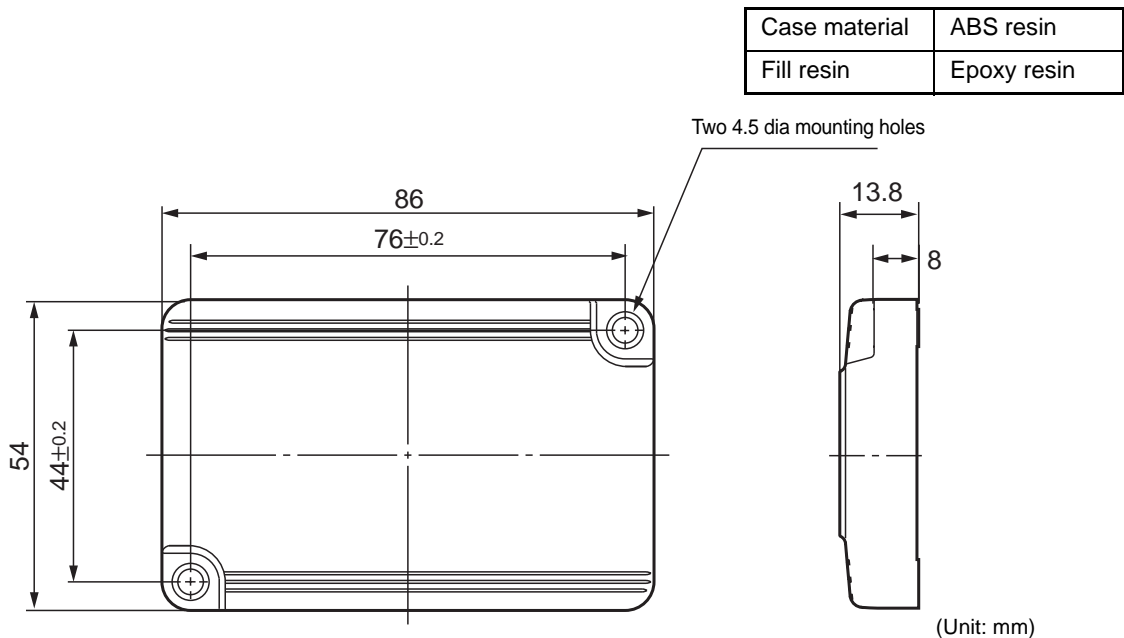

WARNING

A lithium battery is contained in an ID Tag. Do not disassemble, deform under pressure, heat to above 212 °F (100°C), or incinerate the ID Tag. Otherwise serious injury may result from fire or rupturing of the battery.



3-2-3 Memory Map

◆ User Data

The memory capacity for user data on an ID Tag is 8,192 bytes. The minimum unit of memory is 1 byte and memory is specified using addresses (0000h to 1FFFh). h: Hexadecimal number

Data address	Bit								Writing by user	Related commands
	7	6	5	4	3	2	1	0		
0000h to 1FFFh	User data (8 kbytes) Initial values: All 00h								Possible	Section 6-7-1, 6-7-3 to 6-7-7

◆ System Data

In addition to user data, system data is included in the ID Tag memory. Uppercase words, such as DATE are used as addresses. For details on reading and writing, refer to Section 6-7-1 to 6-7-5.

Content	Bit								Writing by user	Related commands
	7	6	5	4	3	2	1	0		
Date of manufacture	Thousand's place of Year				Hundred's place of Year				Not possible	Section 6-7-1 and 6-7-3
	Ten's place of Year				One's place of Year					
	Ten's place of Month				One's place of Month					
	Ten's place of Day				One's place of Day					
ID code	8 bytes *A value inherent to the Tag.								Not possible	Section 6-7-2
Write Protect data	4 bytes *Refer to Section 4-6 Initial value: Write Protect disabled in all the areas.								Possible	Section 6-7-1, 6-7-3 to 6-7-5
Sleep waiting time	2 bytes *Refer to Section 4-7. Initial value: 4800 (8 minutes). Set in units of 100 ms.								Possible	

3-2-4 Battery Life Characteristics

The ID Tag contains a battery. The charts below show the relation between the ID Tag battery life, number of communications bytes, and ambient temperature. The battery life is the time until the battery voltage alarm is given.

Communications Data and Battery Life (at an Ambient Temperature of 25°C)

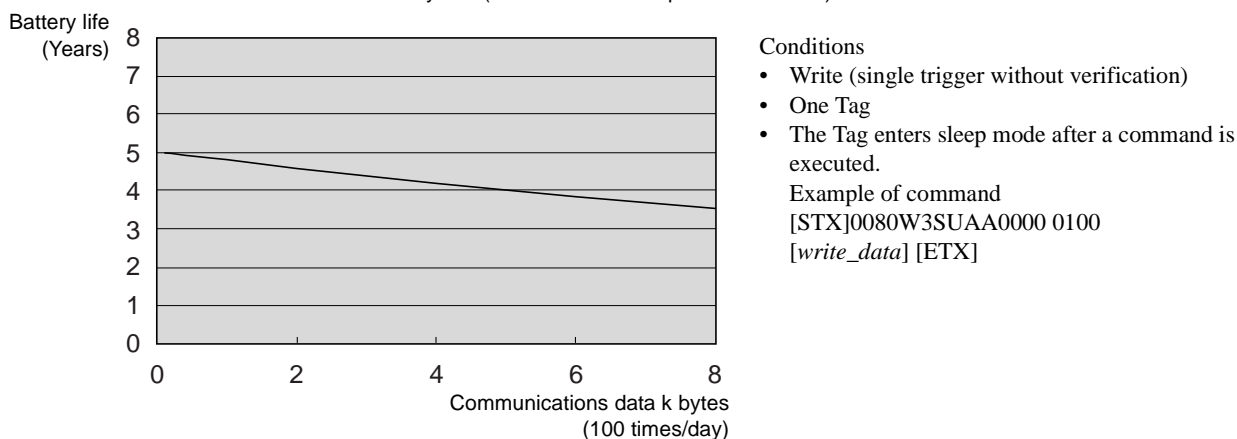

Ambient Temperature and Tag Battery Life (256 bytes x 100 times/day)

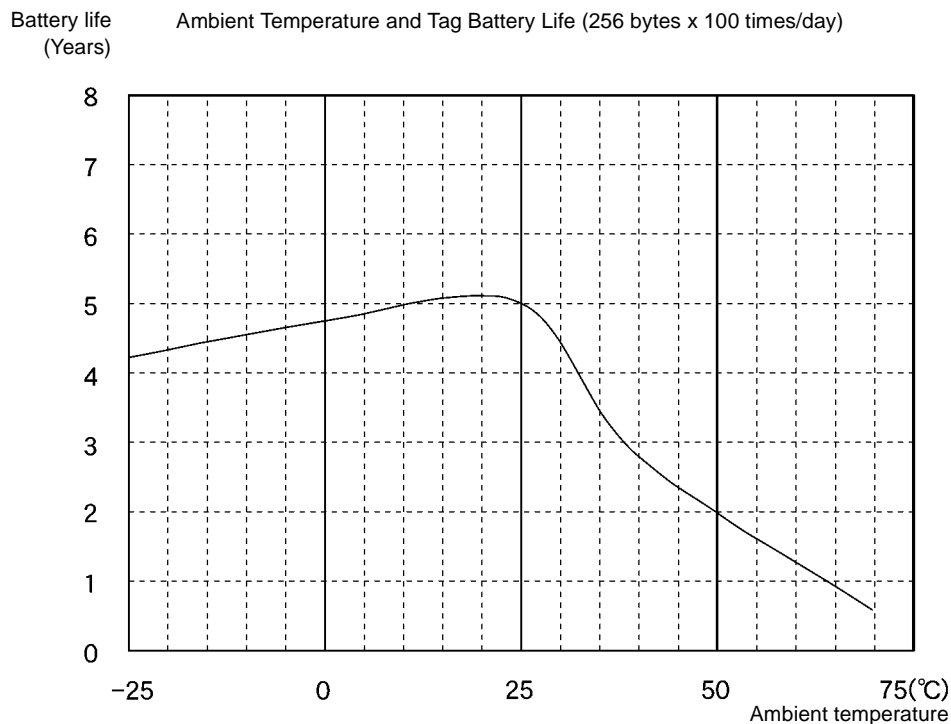

3-2-5 Battery Voltage Alarm Function

When the voltage of the battery in an ID Tag becomes low, 7B will be returned as the end code when a Tag communications command (Read or Write) is executed.

Precaution for Correct Use

After the end code 7B is first returned, the ID Tag can be used for approximately one month in normal situations. We recommend, however, that you replace the Tag with a new one immediately. If the ambient temperature is 0°C or lower, an end code of 7B may be returned even if the battery has sufficient charge. End codes of 7B can generally be ignored if the temperature is 0°C or lower.

3-3 V690-L01 RS-422A/485 Link Unit

3-3-1 Specifications

Item	Specifications
Interface specifications	RS-422A, RS-485
Power supply voltage	24 VDC
Allowable voltage	20.4 to 26.4 VDC
Power consumption	6 W max.
Operating temperature	0 to 55°C (with no icing)
Operating humidity	35% to 85% (with no condensation)
Storage temperature	-10 to 65°C (with no icing)
Storage humidity	35% to 85% (without condensation)
Insulation resistance	20 MΩ min. (at 100 VDC) between the cable terminals as a group and the case, excluding GR
Withstand voltage	1,000 VAC, 50/60 Hz for 1 minute, detected current of 20 mA or less between the cable terminals as a group and the case, excluding GR
Degree of protection	IP30 (IEC60529) *When connected to connector on V690-A5□ Connecting Cable.
Vibration resistance	10 to 150 Hz, single amplitude 0.35 mm, maximum acceleration 50 m/s ² sweeping 10 times for 8 minutes in X, Y, and Z directions
Shock resistance	150 m/s ² 3 times each in X, Y, and Z directions, i.e., 18 times total
Ground	Ground to 100 Ω or less.
Weight	450 g or less

3-3-2 Dimensions

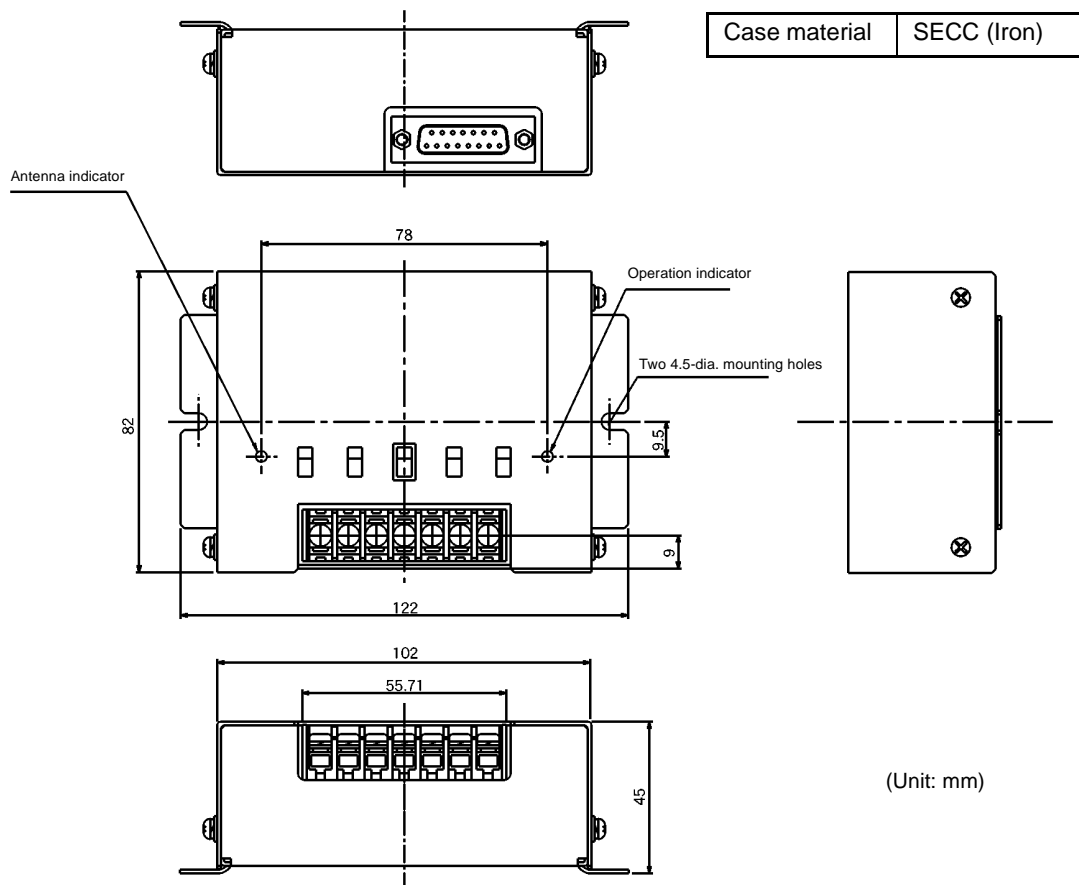

3-3-3 Function

The Link Unit functions as a relay when operation is controlled through RS-422A/RS-485 communications between the host and Antenna. For an example of internal circuits, refer to Section 5-2-2.

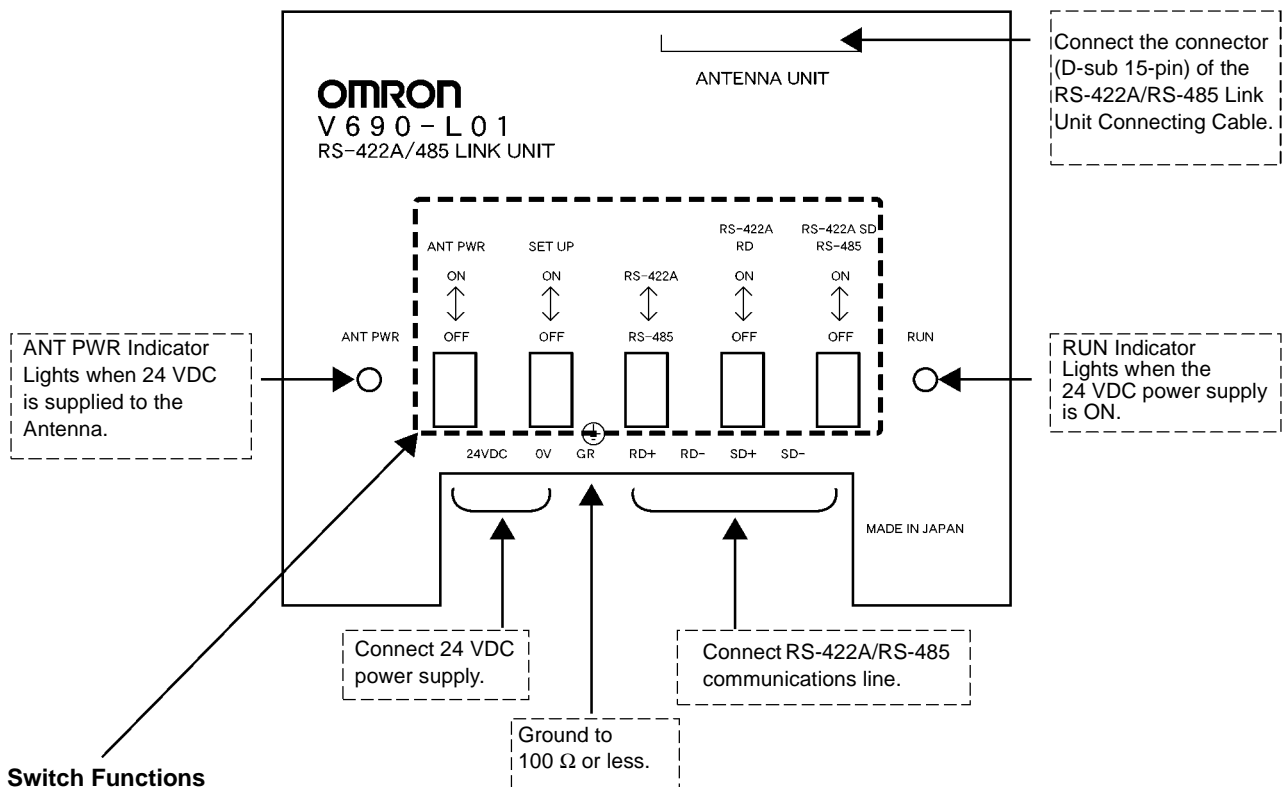

Switch Functions

ANT PWR	SET UP	RS-422A/ RS-485	RS-422A RD (Receiving)	RS-422A SD (Sending) RS-485
Turn ON to supply power to the Antenna. Turn OFF to turn OFF the power to the Antenna.	Turn ON to short-circuit the setting mode terminals (+P and -P). Turn OFF to open the circuit between the setting mode terminals (+P and -P).	Switches between RS-422A and RS-485.	Connects/disconnects the terminating resistance (220 Ω) of RS-422A RD (Receiving) for RS-422A communications. The terminating resistance cannot be turned ON/OFF for RS-485 communications.	Connects/disconnects the terminating resistance (220 Ω) of RS-422A SD (Sending) for RS-422A communications. The terminating resistance cannot be turned ON/OFF for RS-485 communications.

Precautions for Correct Use
Always connect a grounding wire. Otherwise, errors may occur in operation.
Do not touch any terminal when the power supply is turned ON. Otherwise, an error may occur in operation.
Do not disassemble the Unit or touch the inside when the power supply is turned ON. Otherwise, the Unit may fail.

3-4 Connecting Cables

3-4-1 Specifications

Item	Specifications
Cable outer diameter	7.5 mm
Cable color	Dark gray
Sheathing material	Vinyl chloride resin
Number of cores	12 (Three AWG22 lines for power supply and GR and nine AWG26 lines for signals)
Insulation resistance	50 MΩ/km min. between the cables as a group and the cable sheath
Withstand voltage	500 VAC for 1 minute between the cables as a group and the cable sheath

3-4-2 Dimensions

(1) RS-232C Connecting Cables (for IBM PC/AT or Compatible)

Item	Specifications
Connector at Antenna	Round connector (watertight)
Connector at host	D-sub 9-pin, female (not watertight)

Model	Cable length
V690-A40	2 m
V690-A41	3 m
V690-A42	5 m
V690-A43	10 m
V690-A44	15 m

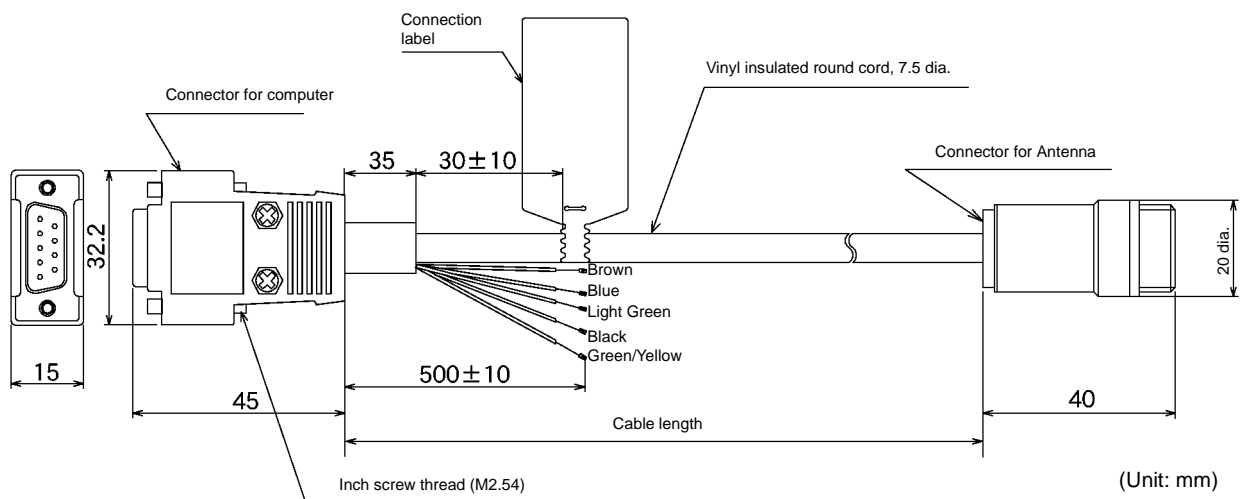

(2) RS-422A/485 Link Unit Connecting Cables

Item	Specifications
Connector at Antenna	Round connector (watertight)
Connector at Link Unit	D-sub 15-pin, male (not watertight)

Model	Cable length
V690-A50	2 m
V690-A51	3 m
V690-A52	5 m
V690-A53	10 m
V690-A54	20 m
V690-A55	30 m
V690-A56	50 m

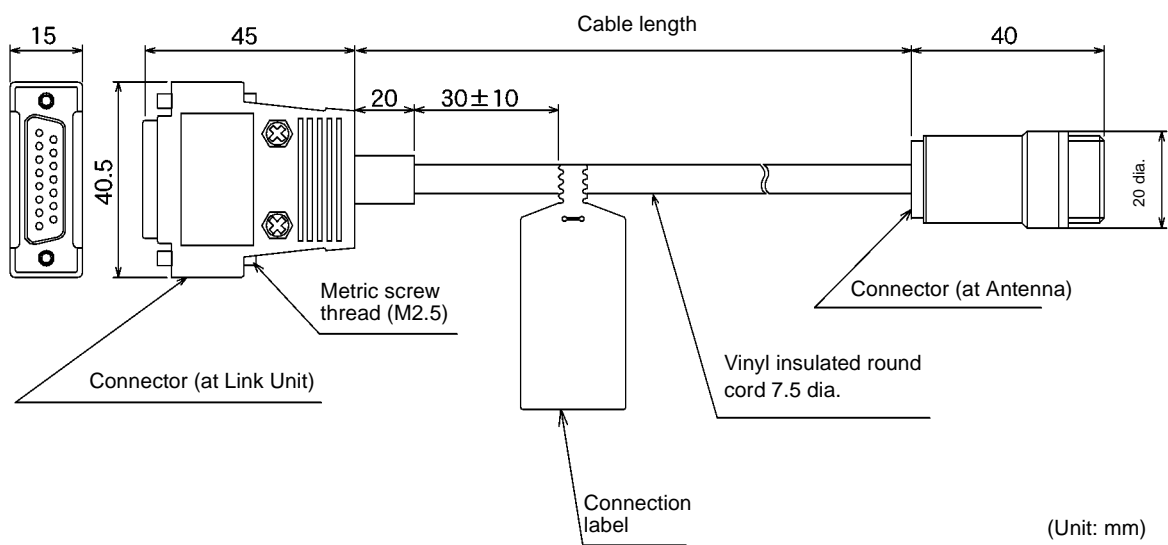

3-5 Tag Communications Performance

Item	Specifications
Frequency	2,450 MHz band (microwave, 2,434.25 to 2,465.75 MHz)
Type of wireless station	Classified as a specified low-power wireless station - wireless equipment for mobile object identification (RCR STD-29 Version 3.0) in Japan. *The user is not required to apply for a license for a wireless station in Japan.
Transmission output at modulation	5 mW for low-power (2 m) mode and 10 mW for high-power (5 m) mode
Polarized waves	Circularly polarized wave
Output power mode (communications range)	Low-power (2 m) mode/high-power (5 m) mode switched by host command. (Section 4-2) Low-power mode: 0.2 to 2.0 m (reference value) High-power (5 m) mode: 0.2 to 5.0 m (reference value) *Conditions for reference value <ul style="list-style-type: none"> • Ambient temperature of 20±5°C • Place the Tag at a suitable rotating position so that the logo "omron" is upright. (Refer to the figure below.) • Place the Tag on the center axis of the Antenna at a height of 1.5 m in a large room where radio wave noise is minimal.
Communications speed	600 kbps
Communications error check	16-bit CRC bidirectional check (CRC: Cyclic Redundancy Check)

Tag rotation: 0 degrees

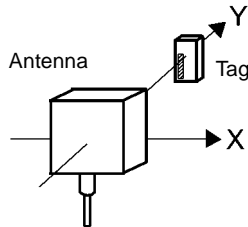

*The hatched area  on the Tag is the "omron" logo.

Precautions for Correct Use

- The communications range depends on the installation site environment. This is because metal materials and the ground reflect a radio wave, and water and the human body absorb it. Place the Antenna and Tag in the communications range and check the radio wave environment in advance.
- The V690-HMG01A Read/Write Antenna has a communications test command to check the radio wave environment at the working site. (Refer to Section 4-5.)

3-6 Host Communications Specifications

Item	Specifications	Remarks
Applicable standards	RS-232C RS-422A RS-485	Note 1
Communications method	Bidirectional half-duplex transmissions	
Baud rate	4,800 bps, 9,600 bps, 19,200 bps, 38,400 bps, 57,600 bps, and 115,200 bps	Note 2
Synchronization method	Start-stop synchronization (1 or 2 stop bits)	Note 2
Transmission code	ASCII 7 bit or JIS 8 bit	Note 2
Maximum number of connected Antennas	32	
Error control	Vertical parity (even, odd, none). Horizontal parity is used as BCC.	Note 2
Line length	RS-232C: 15 m max. RS-422A: 300 m max. RS-485: 300 m max.	

Note 1. The Antenna is equipped with RS-232C and RS-422A terminals. Refer to Section 3-1-3. RS-422A/485 is connected through the Link Unit.

Note 2. Switched by a command from the host. (Refer to Section 6-9-7.)

Chapter 4 Functions

4-1 Single, FIFO, and Multi Mode Access

You can use one of the three communications modes according to the number of Tags in the communications area and the situation. The communications mode can be specified in the communications designation of a command.

(1) Single Mode

In Single mode, a communication is made with one Tag in the Antenna communications area. In Single mode, only one Tag must be in the Antenna communications area. If two or more Tags are in the Antenna communications area, a communications error will occur.

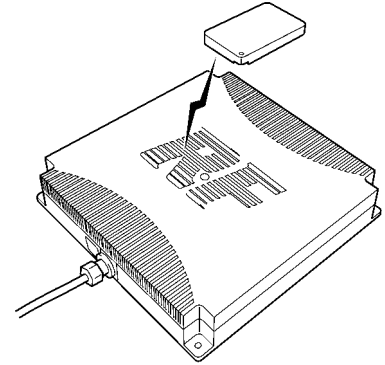

(2) FIFO Mode (First-In First-Out)

FIFO mode enables accessing Tags entering the communications area sequentially one by one. When the communication with one Tag has been completed, the Tag is prohibited from communicating again. Even if there are Tags that have completed communications in the Antenna communications area, a communication will be made with the next Tag that entered the area. When a Tag prohibited from communicating has gone out of the Antenna communications area, communications with that Tag will be enabled again.

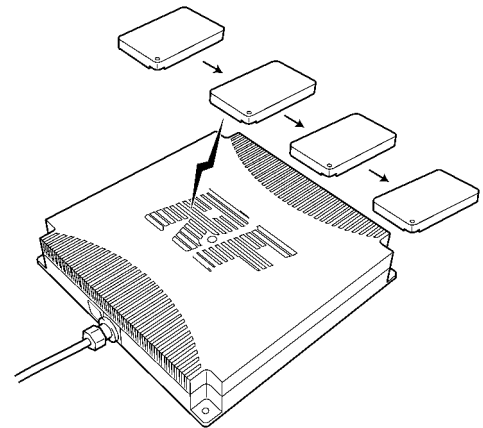

(3) Multi Mode

Multi mode enables accessing all the Tags in the Antenna communications area. A Selective Access function can be used to communicate only with specific Tags in the Antenna communications area.

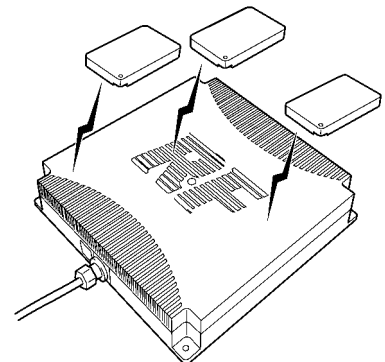

Precaution for Correct Use

When you use FIFO mode, do not allow more than one Tag to enter the Antenna communications area simultaneously. If more than one Tag enters the Antenna communications area simultaneously, a communications error will occur and communications will not be possible until there is only one Tag in the Antenna communications area.

4-2 Switching between Low-power (2 m) and High-power (5 m) Mode

You can switch between the low-power (2 m) and high-power (5 m) output power mode by using a command from the host. Use either one depending on the working site.

For information on the command, refer to Section 6-9-2 and 6-9-3. The default value is the low-power mode.

For information on the communications range for the low-power mode and high-power mode, refer to Section 8-1.

4-3 Radio Wave Channel Switching

In this RFID System, the 2,450 MHz frequency band frequencies from 2,437.5 to 2,462.5 MHz can be divided into 10 channels (at 2.5-MHz intervals). Those channels can be switched using a command from the host. Use them to prevent mutual interference between Antennas or interference caused by any other devices.

For information on the command, refer to Section 6-9-2 and 6-9-3. The default value is Channel 5 (2,450 MHz).

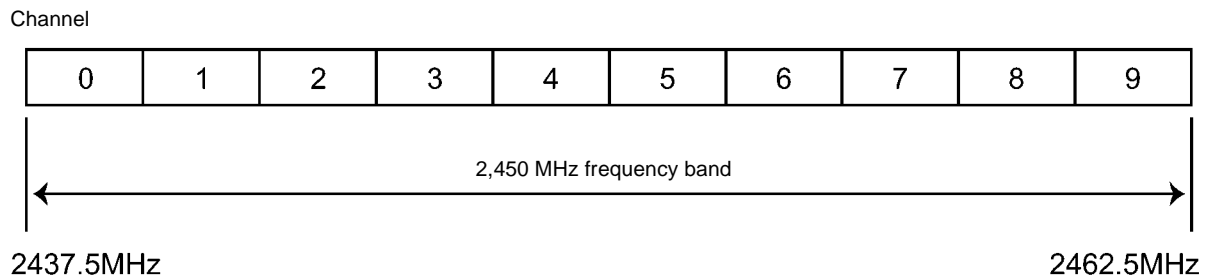

Laws and Standards

- Always use the low-power (2 m) mode when using the Antenna in the USA.
- Always use radio wave channel 5 when using the Antenna in Iceland, Ireland, England, Italy, Austria, the Netherlands, Greece, Switzerland, Spain, Denmark, Norway, Finland, France, Belgium, or Luxemburg.

Precaution for Correct Use

Due to frequency dispersion, adjacent channels may overlap each other. Do not assign consecutive numbers to the channels of adjacent Antennas.

4-4 Simplified Communications Test

You can check communications between an Antenna and Tag using the Antenna only without connecting to the host.

In the simplified communications test, the Antenna detects the Tag approximately every 2 seconds and, if the Tag responds, it lights the C indicator.

- (1) Turn OFF the power supply.
- (2) Short-circuit the setting terminals +P and -P.
- (3) Turn ON the power supply. The setting mode will be enabled. (Refer to Section 6-1.)
- (4) The simplified communications test will start. As shown below, the C indicator (radio wave emission) shows whether communications with the Tag are successful.
- (5) The communications test will stop when any command is sent from the host to the Antenna.

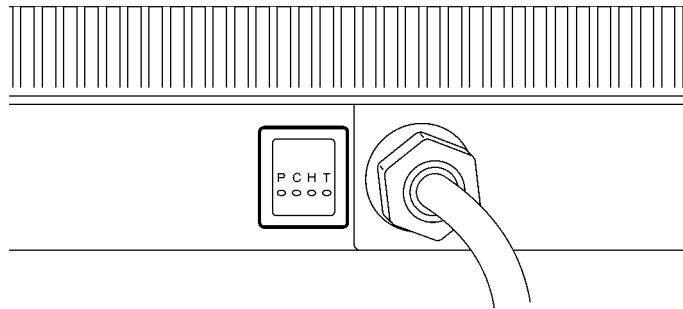

Antenna indicators				Meaning
P (green)	C (red)	H (yellow)	T (green)	
Power supply	Radio wave emission	Host transmission	Tag transmission	
Lit	Flashing	Not lit	Flashing	C and T flash approximately every 2 seconds. This shows that there is no Tag.
Lit	Lit	Not lit	Flashing	C lights. This shows that there is a Tag in the Antenna communications area.

Flashing: Flashing approximately every 2 seconds. (This shows that data is being sent.)

4-5 Communications Test

Execute the communications test to check the radio wave environment at the working site.

Data (256 bytes) is communicated 256 times between the Antenna and Tag and the communications status is output. A total of 128 kbytes of data is communicated in two directions. A few seconds is required to execute this test. Communications are not retried. Refer to Section 6-7-8.

- (1) Create a communications program at the host.
- (2) Enable the operation mode. (Disconnect the terminals +P and -P from each other. Refer to Section 6-1.)
- (3) Turn ON the power supply.
- (4) Put the Tag in front of the Antenna.
- (5) Send a communications test command (Section 6-7-8). If the Antenna is 00, the command is [STX]0080T0SU[ETX].
- (6) If the Antenna responds to the host, the communication between the host and Antenna was made successfully.
- (7) In the response [STX]8000T0000256□□[ETX], the radio wave environment value □□ will be between 0000 and 0256. If the value is close to 0000, communications with the Tag are stable.

Example of response from Antenna:

*Radio wave environment is good.

```
[STX] 8 0 0 0 T 0 0 0 0 2 5 6 0 0 0 0 [ETX]
```

Number of communications	Radio wave environment value
-----------------------------	---------------------------------

*Radio wave environment is poor or there is no Tag in the communications area.

```
[STX] 8 0 0 0 T 0 0 0 0 2 5 6 0 2 5 6 [ETX]
```

Number of communications	Radio wave environment value
-----------------------------	---------------------------------

Precaution for Correct Use

We recommend you to maintain a radio wave environment value of 50 or less.
--

4-6 Write Protect Function

You can enable write protection for user data (8 kbytes) for each page (256 bytes). Write protection prevents data from being destroyed by accidental writing.

◆ Scope of Write Protection

The addresses of pages P0 to P31 are listed below.

Page	256 bytes/page
P0	0000 to 00FF (h)
P1	0100 to 01FF (h)
P2	0200 to 02FF (h)
.	.
.	.
.	.
P30	1E00 to 1EFF (h)
P31	1F00 to 1FFF (h)



256 bytes x 32 pages = 8,192 bytes

*(h) means that the value is a hexadecimal number.

◆ Enabling Write Protection

The 32 bits of Write Protection data (4 bytes) in the system data (refer to Section 3-2-3) correspond to the pages of Tag memory. A page can be write-protected by setting the bit corresponding to the page to 1 (enable). To disable write protection, clear the bit to 0.

The relation between the bits in write protection data and pages is shown below.

Write protection data (4 bytes)



Code	Bit								Description
	7	6	5	4	3	2	1	0	
A1	P7	P6	P5	P4	P3	P2	P1	P0	Status of Write Protection 0: Disabled (Default value) 1: Write-protected
A2	P15	P14	P13	P12	P11	P10	P9	P8	
A3	P23	P22	P21	P20	P19	P18	P17	P16	
A4	P31	P30	P29	P28	P27	P26	P25	P24	

P** : Status of write protection for page ** (between 0 and 31).

◆ Examples of Write Protection

(1) The write protection data to write-protect pages P3 and P14 in the initial state of the ID Tag would be as follows:

	A 4	A 3	A 2	A 1
Binary notation	0 0 0 0 0 0 0 0	0 0 0 0 0 0 0 0	0 1 0 0 0 0 0 0	0 0 0 0 1 0 0 0
Hexadecimal notation	0 0	0 0	4 0	0 8

The Write command (Section 6-7-4) would be as follows:

STX	D A	S A	Command code	Communications designation	Split flag	Data designation	Start address	Number of write bytes	Write data	ETX
	0 0	8 0	W 1	S U	A	H	W P R O	0 0 0 4	0 0 0 0 4 0 0 8	

The response from the Antenna for a normal end would be as follows:

STX	S A	D A	Command code	End code	Response number	ID code	ETX
	8 0	0 0	W 1	0 0	0 1	* * * * *	

(2) The write protection data to disable write protection for page P14, which was write-protected in the step (1), and to write-protect P17 and P28 would be as follows:

	A 4	A 3	A 2	A 1
Decimal notation	0 0 0 1 0 0 0 0	0 0 0 0 0 0 1 0	0 0 0 0 0 0 0 0	0 0 0 0 1 0 0 0
Hexadecimal notation	1 0	0 2	0 0	0 8

The Write command (Section 6-7-4) would be as follows:

STX	D A	S A	Command code	Communications designation	Split flag	Data designation	Start address	Number of write bytes	Write data	ETX
	0 0	8 0	W 1	S U	A	H	W P R O	0 0 0 4	1 0 0 2 0 0 0 8	

(3) The write protection data to disable write protection for all pages would be as follows:

	A 4	A 3	A 2	A 1
Decimal notation	0 0 0 0 0 0 0 0	0 0 0 0 0 0 0 0	0 0 0 0 0 0 0 0	0 0 0 0 0 0 0 0
Hexadecimal notation	0 0	0 0	0 0	0 0

The Write command (Section 6-7-4) would be as follows:

STX	D A	S A	Command code	Communications designation	Split flag	Data designation	Start address	Number of write bytes	Write data	ETX
	0 0	8 0	W 1	S U	A	H	W P R O	0 0 0 4	0 0 0 0 0 0 0 0	

4-7 ID Tag Power-Saving Functions

The Tag has the two power-saving functions.

◆ Preventing Battery Power Loss Due to Radio Wave from Other Radio Equipment

This function operates constantly. No settings are necessary.

If any radio equipment is located near a Tag, the Tag will operate (i.e., it will become ready to communicate) because the Tag's receiving band is wide. As a result, the Tag's battery may be consumed. (Refer to *Interference with Second-generation Low-power Data Communications Systems (Wireless LANs), Cellular Phones, etc.* at the beginning of this manual.) To prevent this power loss, the Tag has a function to enter a sleep state (refer to Appendix 1 Glossary) against radio waves emitted from any other wireless equipment.

- The V690 Antenna sends a wake command (refer to Appendix 1 Glossary) every 100 ms after emitting radio waves and the Tag operates (i.e., it will become ready to communicate).
- When the Tag receives radio waves from any other wireless equipment, the Tag may operate (i.e., it will become ready to communicate), but unless it receives a valid wake command, the Tag will return to a sleep state in 2 seconds.

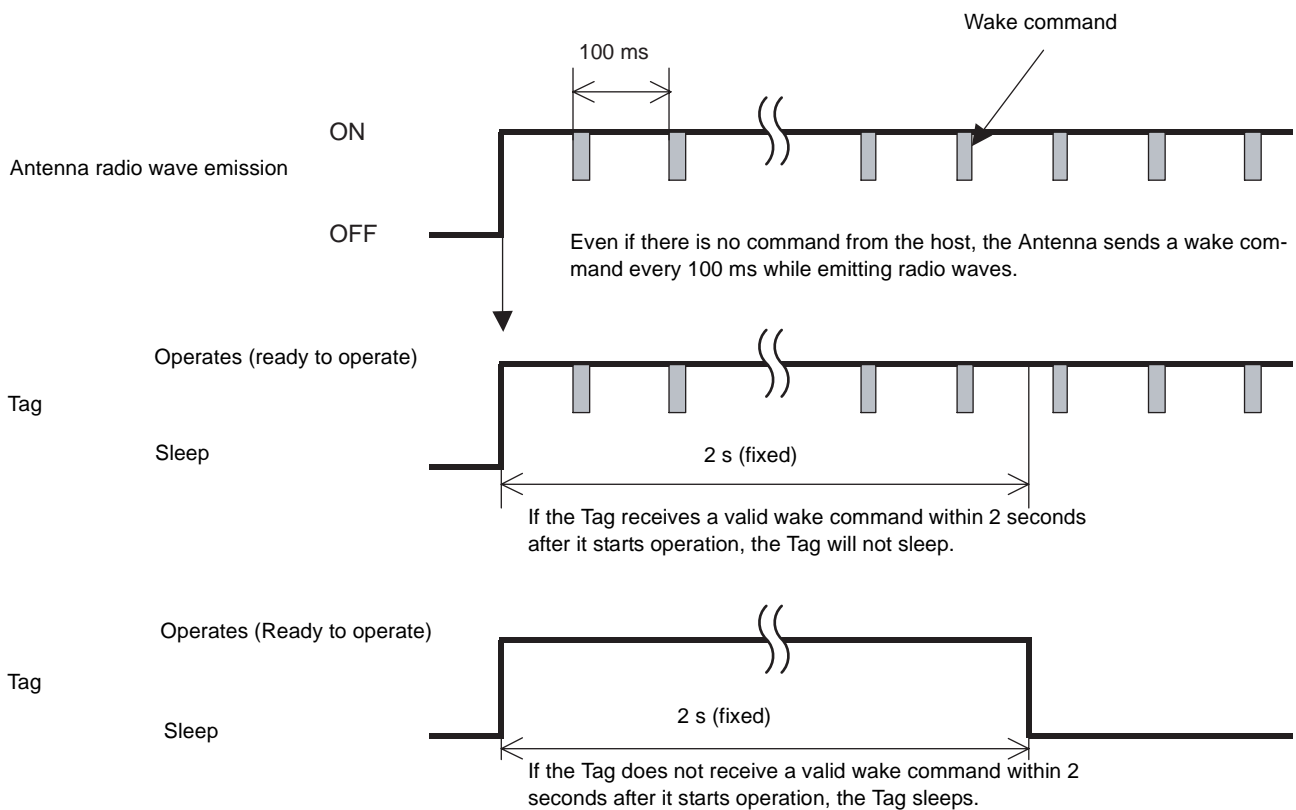

◆ Prevent Battery Power Loss Due to Neglect

This function operates constantly. No settings are necessary.

When you use the Antenna with a Repeat command (refer to (3) in Section 6-2-1), troubles at the working site may cause the Tag to be left in front of the Antenna while it is emitting radio waves, causing the Tag to operate (ready to operate). Here again, the Tag's battery will be consumed. To prevent this power loss, the Tag has a function to enter a sleep state when a waiting time for sleeping (refer to a chart below) has passed.

If the Tag does not receive a valid command within the waiting time for sleeping after receiving a valid command, the Tag enters a sleep state. A default value of the waiting time for sleeping is 480 seconds (8 minutes). To change the waiting time, specify "SLEP" as the address in the Read/Write command. The wait time can be set to between 0000 and 9999 in units of 0.1 s, e.g., $0001 \times 0.1 \text{ s} = 0.1 \text{ s}$ and $4800 \times 0.1 \text{ s} = 480 \text{ s}$. A setting of 0000 sets an infinite time. (Refer to Section 6-7-1 and 6-7-3 to 6-7-5.)

To wake the Tag from the sleep state:

- Turn OFF the power supply of the Antenna and turn it ON again.
- Take the Tag out of the communications area and place it in the communications area again.

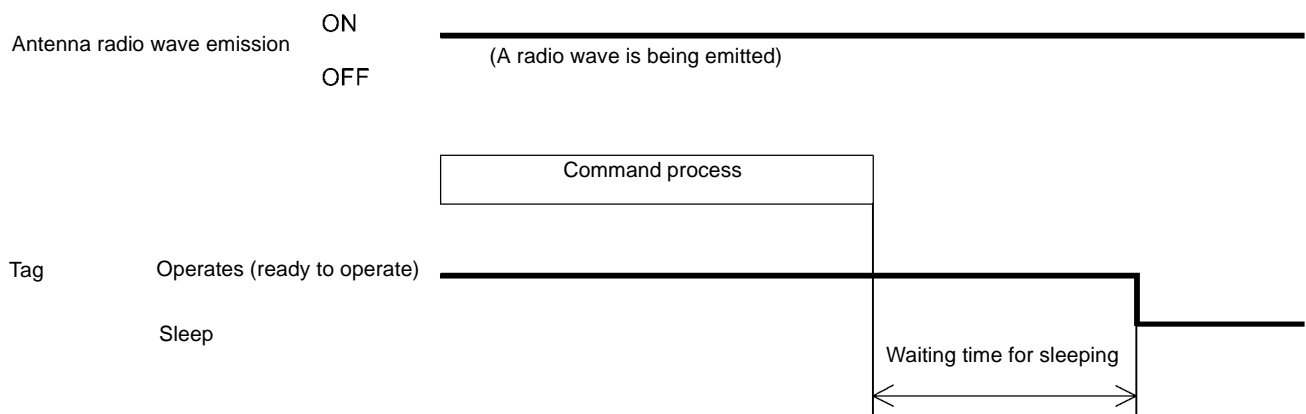

Chapter 5 Installation and Connection

5-1 Read/Write Antenna and ID Tag

5-1-1 Installation Environment

(1) Antenna and Tags

Install the Antenna and Tags so that the front sides of the Antenna and Tags face each other. Confirm the front sides and back sides. The front sides must face each other.

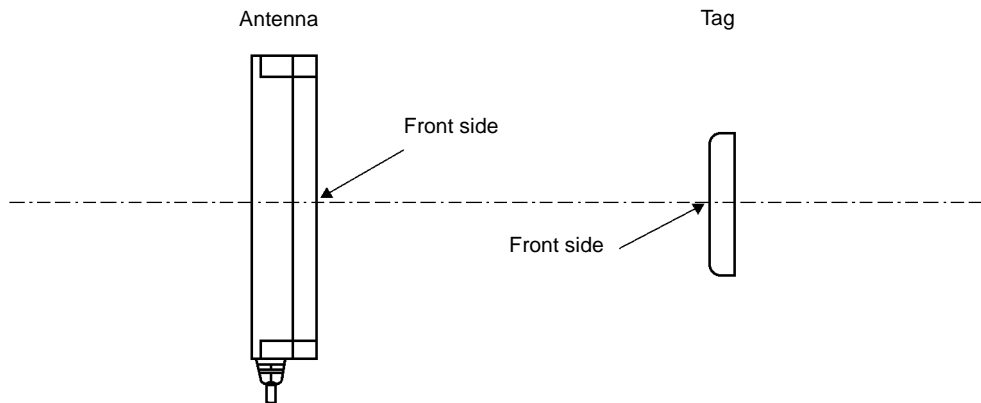

(2) Antennas

Keep sufficient distance between the Antennas according to Section 8-4. If sufficient distance cannot be obtained perform the following:

- Assign the most different channel numbers to the radio channels of adjacent Antennas. (Refer to Section 4-3.)
- Permit only one of Antennas to transmit radio waves at a time so that the Antennas do not transmit radio waves simultaneously.

(3) Tag Rotation in Respect to the Antenna

The Antenna and Tag use circularly polarized waves as radio waves to communicate with each other. The Tags can communicate with the Antenna at any angle of rotation.

• Conceptual Diagram of Circularly Polarized Waves

The arrows show the direction to the oscillating surface. The radio wave propagates while the oscillating surface is rotating.

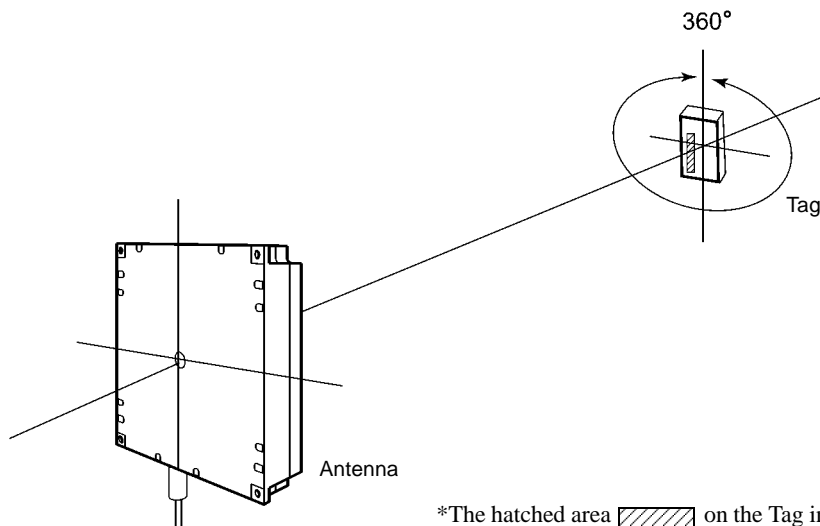

*The hatched area  on the Tag indicates the "omron" logo.

(4) Installation Environment

Do not install the Antenna and Tags in any of the following locations:

- Locations where the ambient temperature is no between -20 and 60°C for the Antenna and -25 and 70°C for the Tag, where the temperature fluctuates considerably, or where condensation can occur
- Locations where the relative humidity not between 35% and 85%
- Locations where there is corrosive gas, flammable gas, dust, salt, or iron powder
- Locations subject to vibration or shock
- Locations subject to splashes of water, oil, or chemicals

5-1-2 Installing the Antenna

Install an Antenna on a flat plane, taking care not to bend it by applying excessive force. As shown below, mount the Antenna with four M5 screws, spring washers, and flat washers. The tightening torque is $2.0\text{ N}\cdot\text{m}$ (approximately $20\text{ kgf}\cdot\text{cm}$). Do not use any lock paint to fix the screws.

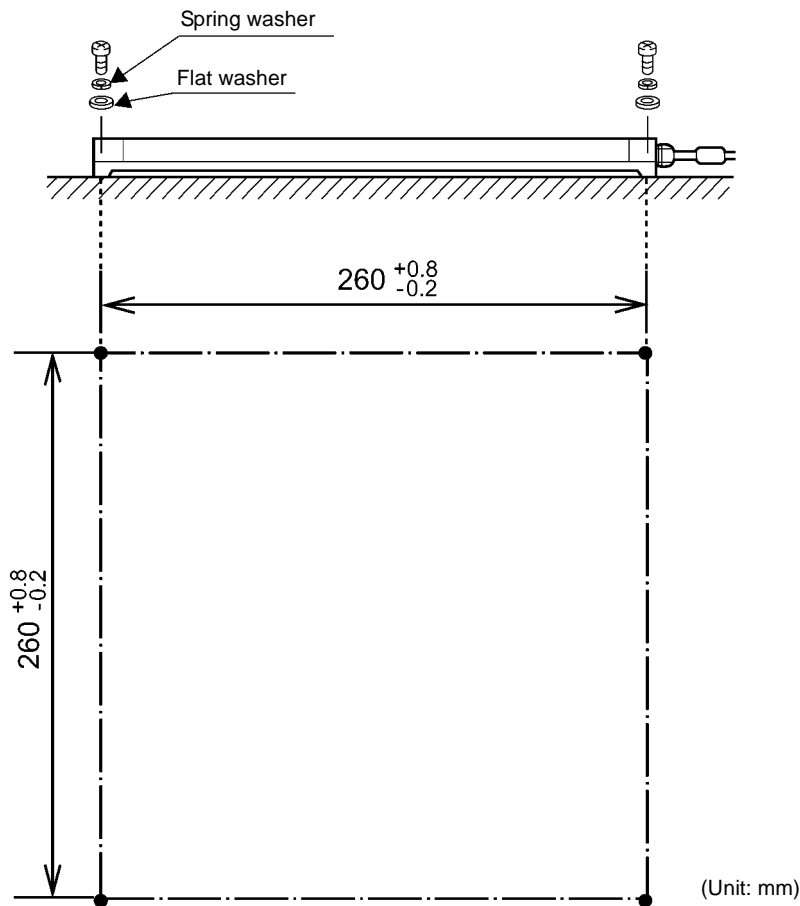

Precaution for Correct Use
Do not disassemble the Unit or touch the inside when the power supply is turned ON. Otherwise, the Unit may fail.

5-1-3 Rainproofing the Antenna

The Antenna is not waterproof. Do not install the Antenna outdoors or in any other location where it would be subject to water without waterproofing it.

If you must install the Antenna outdoors, protect the Antenna against rain with a plastic rainproof box. To prevent water droplets entering the Antenna through a cable, be sure to turn the Antenna cable section downward.

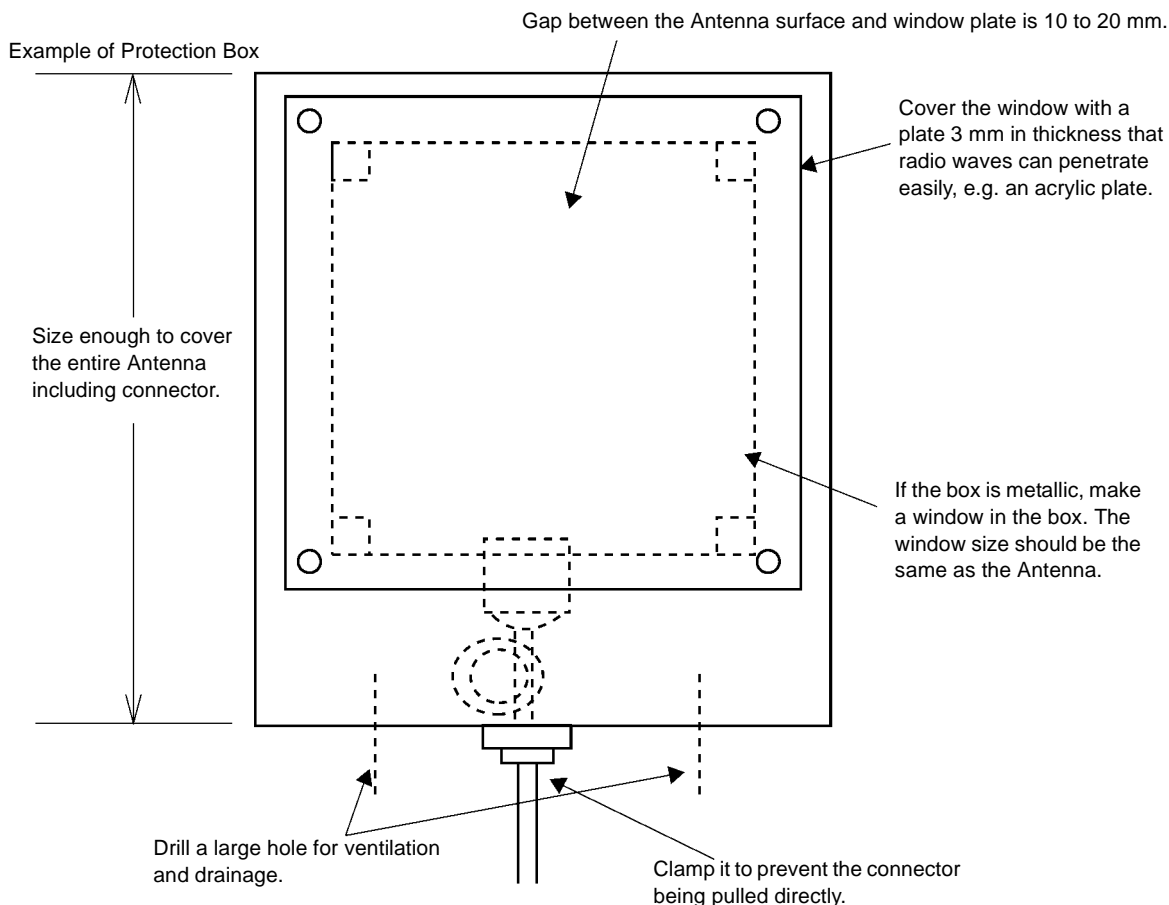

Precaution for Correct Use

The protective structure IP62 of the Antenna is for protection against the drops of water. If the Antenna is splashed with water spray or water jet flow, cover the Antenna with a protection plate. (Refer to Appendix 3 Degree of Protection.)

5-1-4 Install Tags

◆ Installation

Install a Tag on a flat plane taking care not to bend it by applying excessive force. As shown below, mount the Tag with two M4 screws, spring washers, and flat washers. The tightening torque is 1.2 N•m (approximately 12 kgf•cm). Do not use any lock paint to fix the screws.

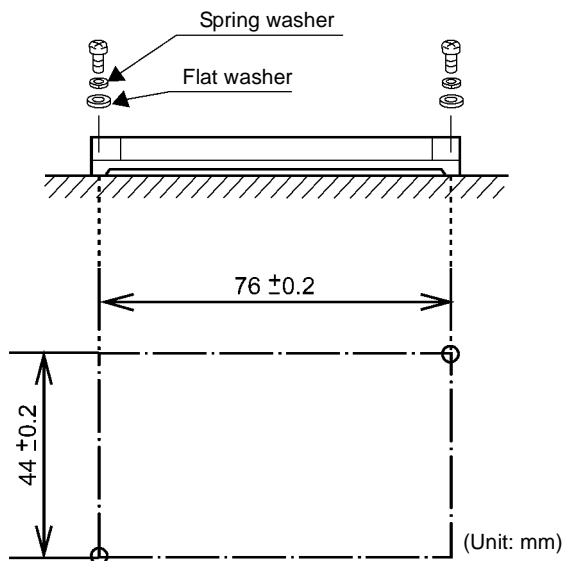

◆ Influence on Communications: Adhesive, Metal Tape, Water Films, Etc.

- When you apply adhesive or other substances to the surface of a Tag, radio waves are attenuated and the communications area may be affected. Performs a communications test under application conditions in advance.
- If a metallic tape is attached to the surface of a Tag, radio waves will be interrupted and communications with the Antenna will fail.
- If the Tag is put on a glass plate with double-sided adhesive tape as shown below, the gap between the glass plate and Tag sweats easily. Moreover, a water film may be generated. In this case, radio waves will be absorbed and the communications range may become smaller.

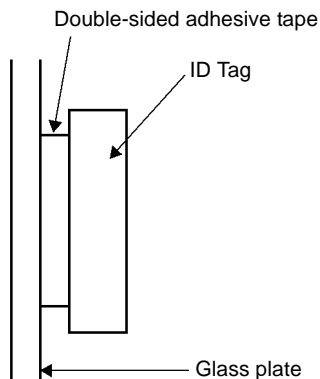

5-1-5 Connecting the Cable to the Antenna

To connect the Antenna and host, use a Connecting Cable (sold separately).

RS-232C Connecting Cable V690-A4□ *Refer to Section 3-4.
RS-422A/485 Link Unit Connecting Cable V690-A5□ *Refer to Section 3-4.

- (1) When you connect the connector on the cable and connector on Antenna, be sure to hold those connectors and insert them into each other completely.
- (2) When you have connected the connectors, turn the ring completely as shown below.

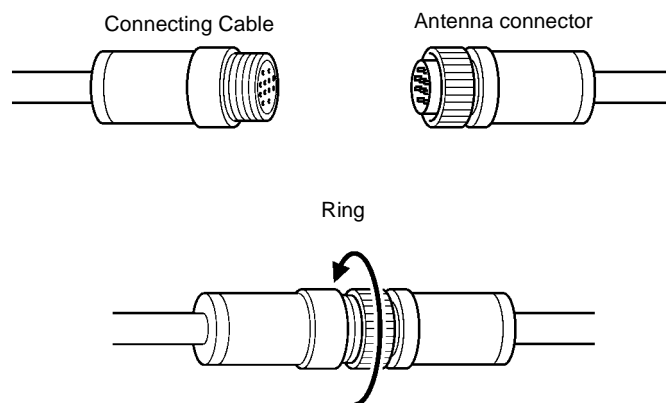

Precautions for Correct Use

- Do not connect or disconnect the connectors when the power supply is ON. Otherwise, product failure may result.
- Do not pull the cable with excessive force.
- Do not touch the connecting terminals on the connector.
- Do not touch the connector during operation.

5-2 Wiring the Host

5-2-1 Wiring an RS-232C Interface

(1) Using RS-232C Connecting Cable

To connect a Read/Write Antenna to an IBM PC/AT or compatible, use a V690-A4□ RS-232C Connecting Cable. Connect the five electric wires at a connector of host as shown below.

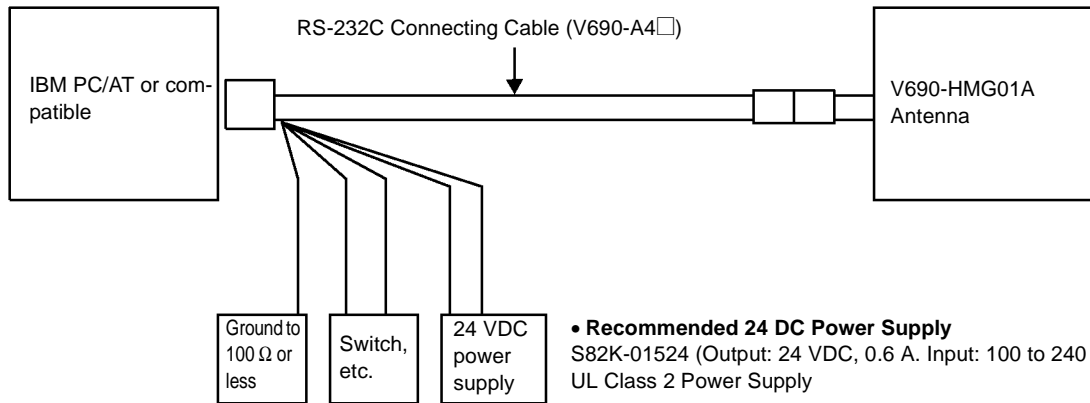

Connecting the Leader Lines of RS-232C Connecting Cable

Leader lines of Connecting Cable		Details of connection
Brown	Thick wire: AWG22	(+) of 24 VDC power supply
Blue		(-) of 24 VDC power supply
Light green	Thin wire: AWG26	+P and -P for the setting mode: Open for operation mode. Short-circuit for setting mode.
Black		
Green/Yellow	Thick wire: AWG22	Ground to 100 Ω or less.

Connector Pin Layout

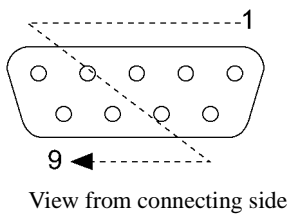

Pin No.	IBM PC/AT or compatible	V690-A4□ RS-232C Connecting Cable
	Socket (Male)	Plug (Female)
1		
2	RD (Receiving)	TX (Sending)
3	SD (Sending)	RX (Receiving)
4		
5	SG (Signal ground)	SG (Signal ground)
6		
7	RS (Request to send)	Loop back (Short-circuit)
8	CS (Clear to send)	
9		

(2) Using RS-232C Connecting Cable to Extend a Cable and Connecting to IBM PC/AT or Compatible (Typical)

To connect an IBM PC/AT or compatible (typical) extending a RS-232C Connecting Cable, prepare the cables as shown below. The wires in the cable must be AWG26 or thicker.

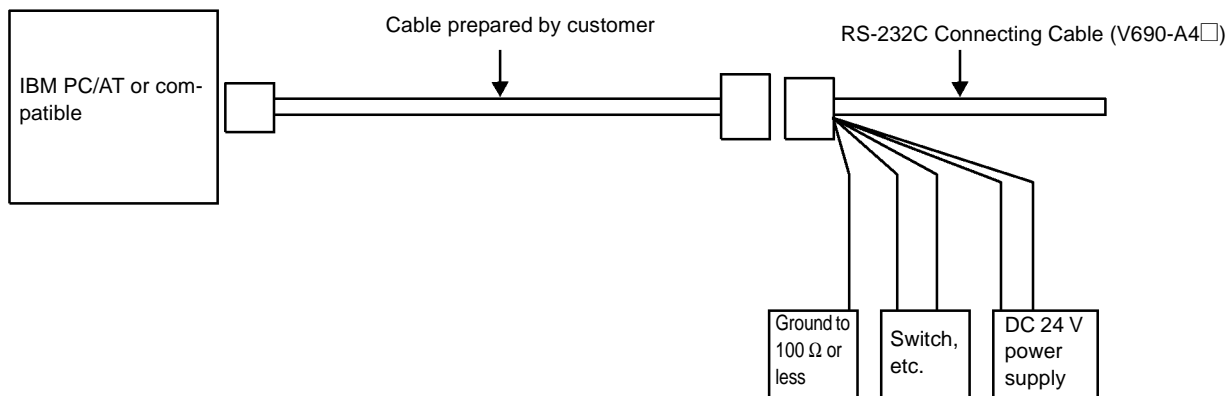

• **Recommended 24 VDC Power Supply**

S82K-01524 (Output: 24 VDC, 0.6 A. Input: 100 to 240 VAC, OMRON)

If you do not use the recommended power supply or an equivalent, connect to the 24 VDC power supply via a line filter.

Pin No.	IBM PC/AT or compatible (typical)	Cable prepared by customer			V690-A4□ RS-232C Connecting Cable
	Socket (Male)	Female	Male		Plug (Female)
1				1	
2	RD (Receiving)			2	TX (Sending)
3	SD (Sending)			3	RX (Receiving)
4				4	
5	SG (Signal ground)			5	SG (Signal ground)
6				6	
7	RS (Request to send)			7] Loop back
8	CS (Clear to send)			8	
9				9	

(3) Connecting to an OMRON PLC

To connect an Antenna and OMRON Programmable Controller (PLC), prepare a V690-A4□ RS-232C Connecting Cable and connection cable.

The wires in the cable must be AWG26 or thicker.

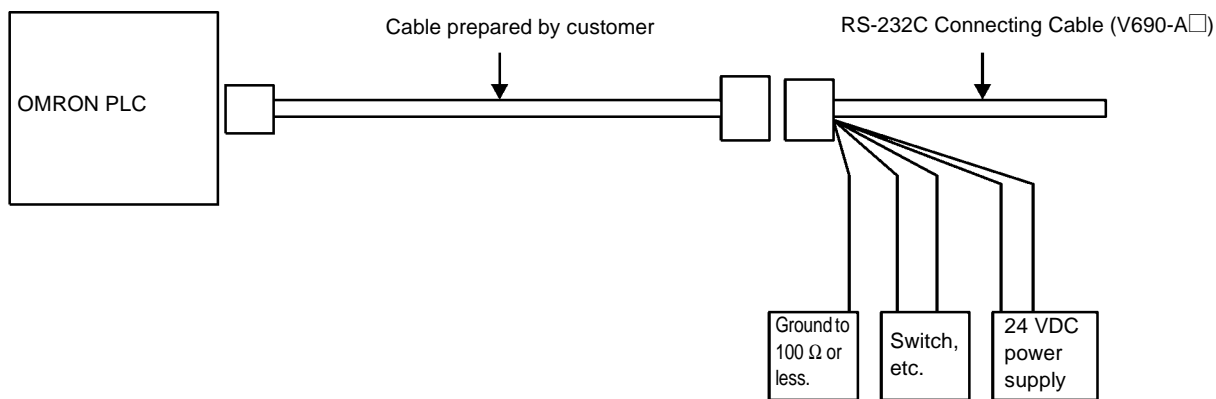

- **Recommended 24 DC Power Supply**
 S82K-01524 (Output: 24 VDC, 0.6 A. Input: 100 to 240 VAC, OMRON)
 UL Class 2 Power Supply

Pin No.	OMRON PLC	Cable prepared by customer		RS-232C Connecting Cable
	Socket (Female)	Male	Female	
1				1
2	SD (Sending)			2 TX (Sending)
3	RD (Receiving)			3 RX (Receiving)
4	RS (Request to send)			4
5	CS (Clear to send)			5 SG (Signal ground)
6				6
7				7 } Loop back
8				8 }
9	SG (Signal ground)			9

Additional connections in the cable prepared by customer:
 - Pin 4 to Pin 5: Loop back (Short-circuit)
 - Pin 7 to Pin 8: Loop back

5-2-2 Wiring for RS-422A/485

(1) 1:1 Connection with Link Unit

To connect an Antenna and host through an RS-422A/485 connection, use the Link Unit. The following example shows the connection of one Antenna and one host through RS-422A (4-wire).

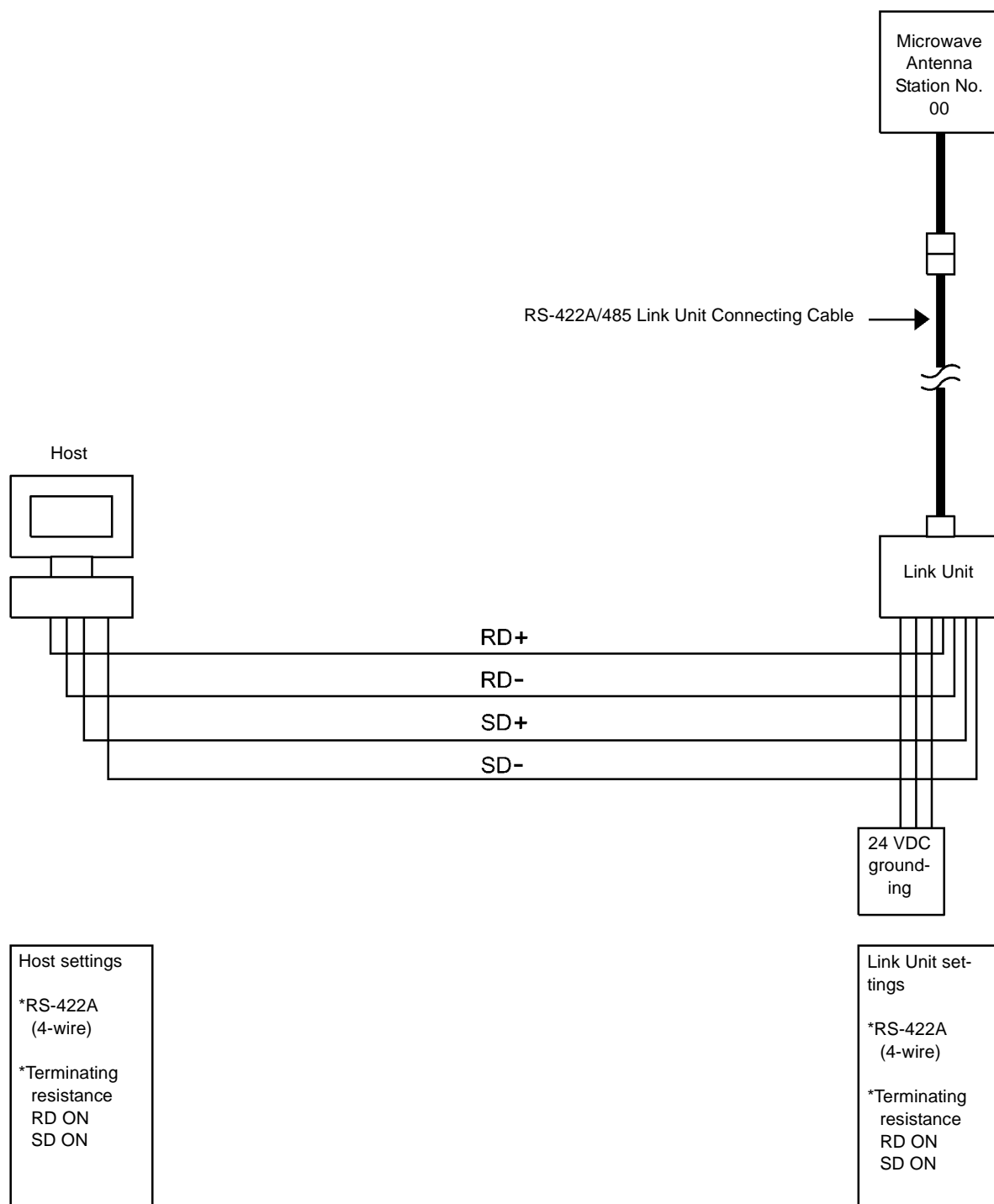

The internal configuration of a 1:1 connection of an Antenna and host through RS-422A (4-wire) is shown below.

- The signal lines (Rx, Tx and SG) of RS-232C are disconnected.
- If RS-422A is selected with the Link Unit, SD and RD terminating resistance (220 Ω) can be turned ON/OFF.

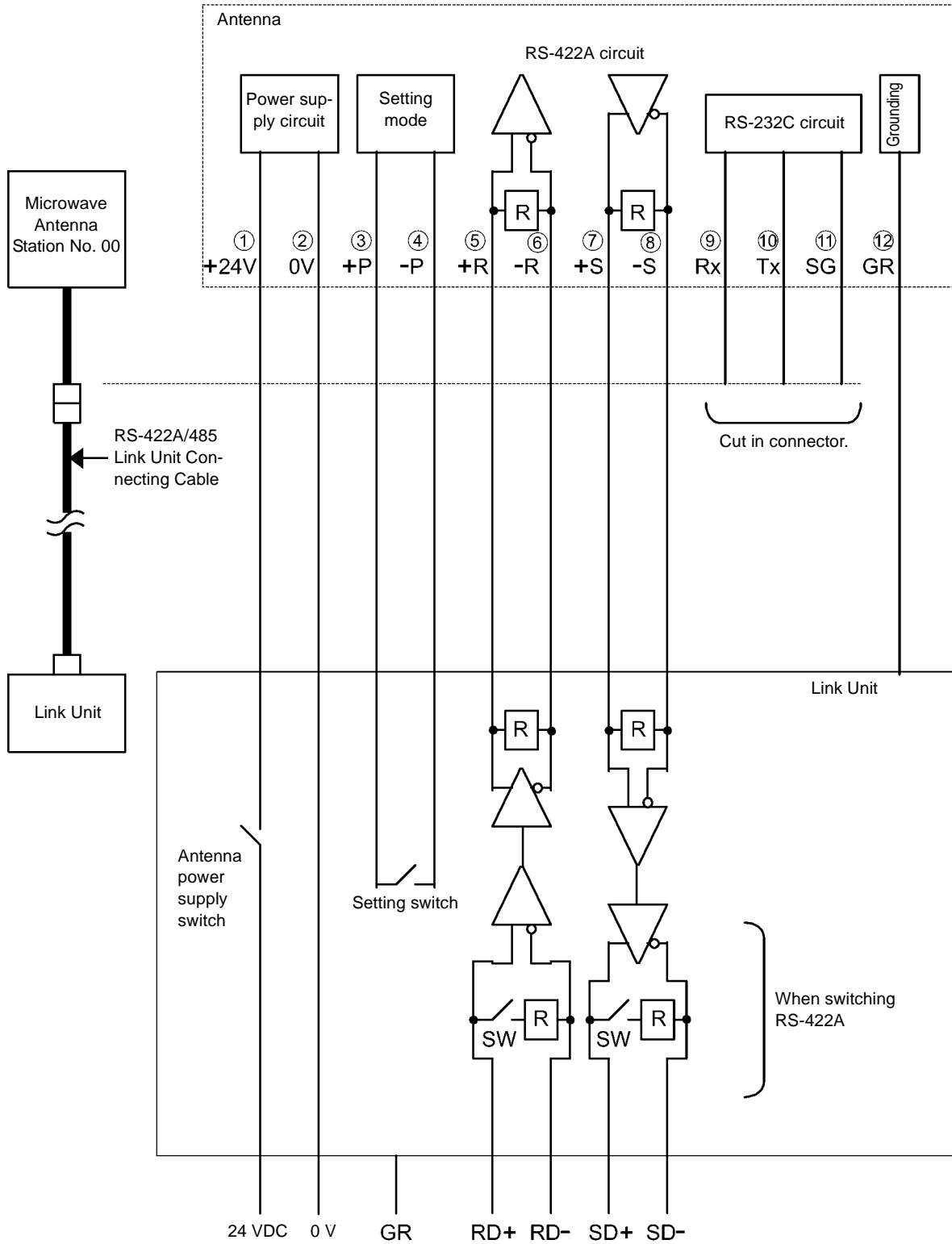

(2) 1:N Connection with Link Unit

To connect several Antennas and the host through RS-422A/485 connections, use Link Units. The following example shows the connection of several Antennas and one host through RS-485 (2-wire).

A maximum of 32 units can be connected.

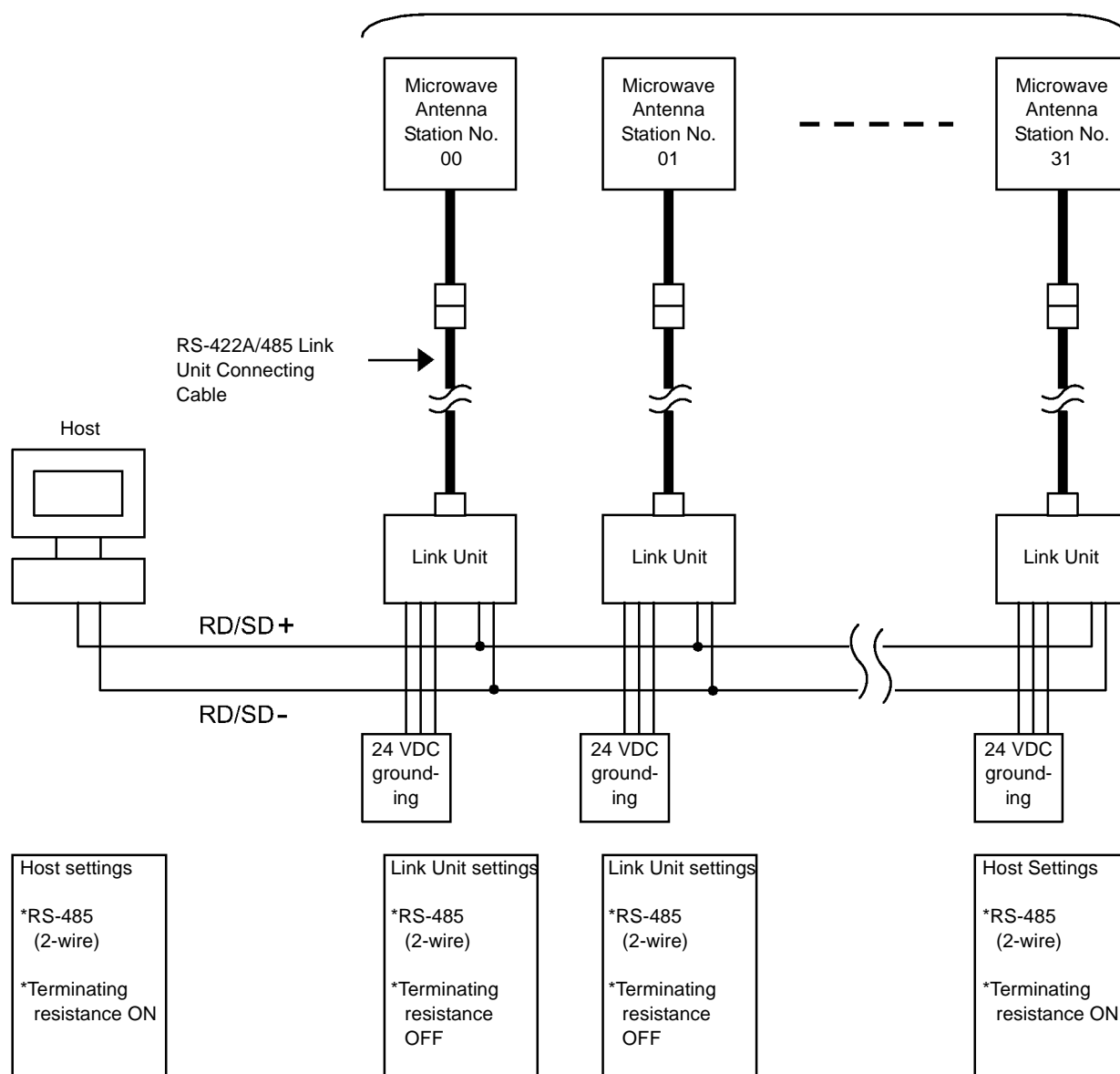
**Precaution for Correct Use**

Turn ON (connected) the terminating resistances at both ends of the entire RS-422A/RS-485 communications wiring.

Precaution for Correct Use

The host must send the next command within 10 ms after checking a response from an Antenna. When you use an RS-232C/485 converter at the host, the command must be sent after the command transmission has been enabled completely. When the command has been sent completely, switch into the receiving state within 10 ms. Otherwise, communications with the Antenna may fail.

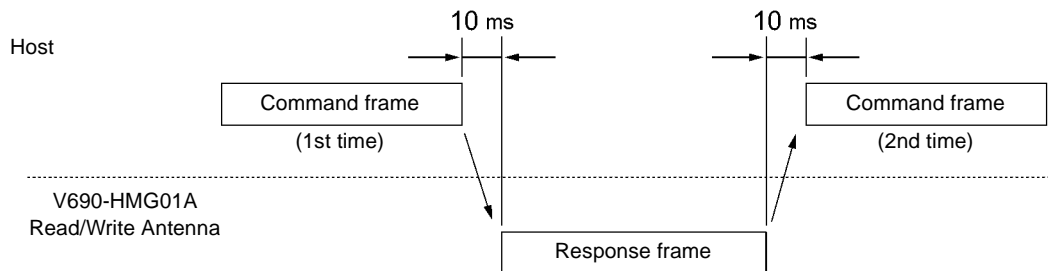

Signal name	V690-A5□	
	Link Unit connector pin number	Antenna connector pin number
+24V	1	A
0V	2	B
+P	3	C
-P	4	D
RD+	5	E
RD-	6	F
SD+	7	G
SD-	8	H
GR	12	M

The internal configuration of the 1:N connection of an Antenna and host through RS-485 (2-wire) is shown below.

- The signal lines (Rx, Tx and SG) of RS-232C are disconnected.
- If RS-485 is selected with the Link Unit, the terminating resistance (220 Ω) can be turned ON/OFF.

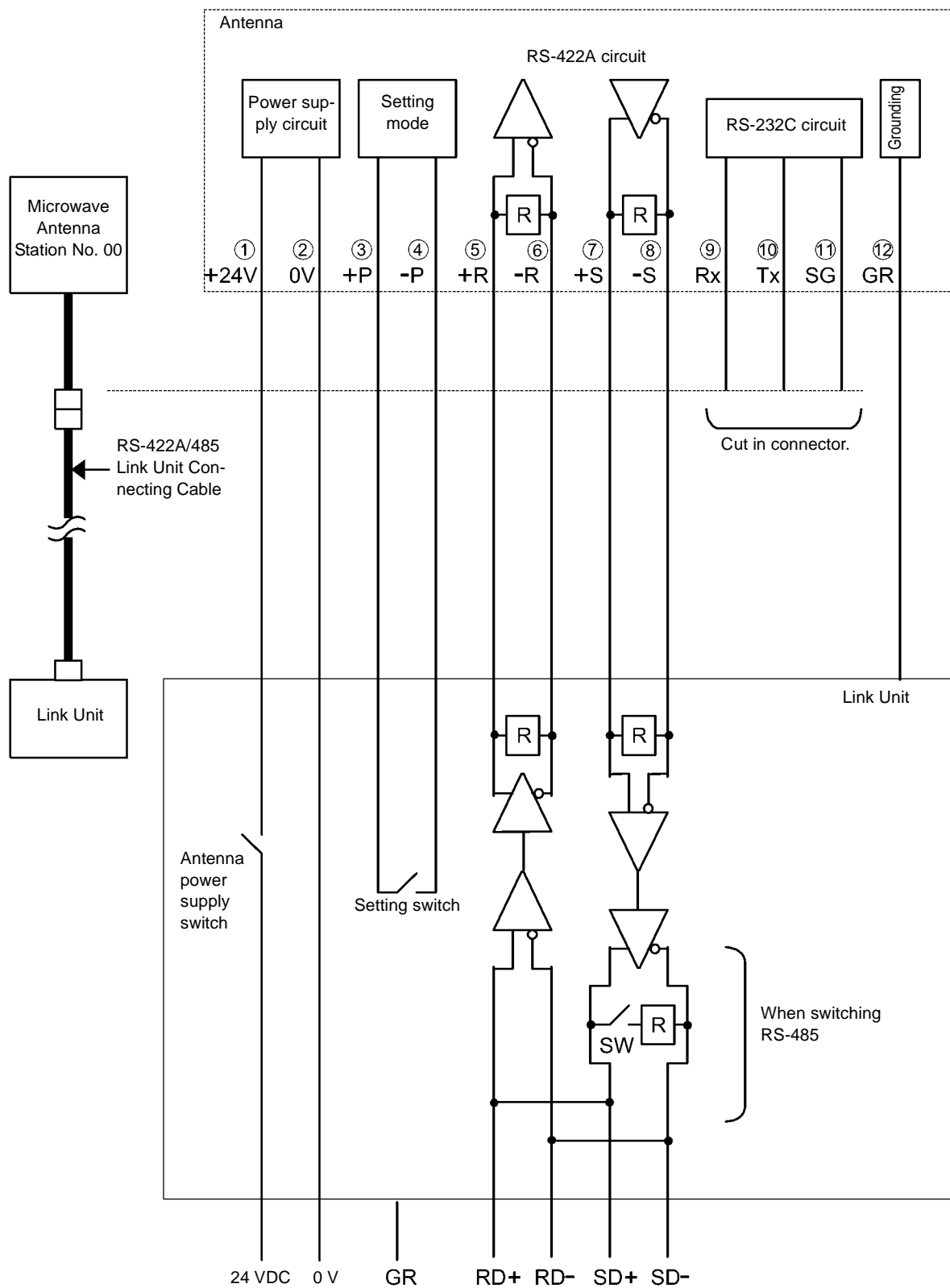

5-3 Link Unit

5-3-1 Installation Environment

◆ Installation site

Do not install a Link Unit in any of the following locations:

- Locations where the ambient temperature is not between 0 and 55°C, where the temperature fluctuates considerably, or where condensation can occur
- Locations where the relative humidity is not between 35% and 85%
- Locations where there is corrosive gas, flammable gas, dust, salt, or iron powder
- Locations subject to vibration or shock
- Locations subject to splashes of water, oil, or chemicals

◆ Assembly in a Panel

The ambient operating temperature of a Link Unit is 0 to 55°C. The following conditions must be met.

- Provide sufficient space for ventilation.
- Do not install the Link Unit near any heat sources (heaters, transformers, and large-sized resistors).
- If the ambient temperature rises to 55°C or higher, install a ventilating fan or air conditioner to keep the temperature at 55°C or less.
- If you wire power lines (e.g., for high currents to drive motors) near the Link Unit, perform a communications test fully to check the influence of noise and wire the power lines with care.

5-3-2 Installing Link Units

Install a Link Unit on a flat plane taking care not to bend it by applying excessive force. As shown below, mount the Antenna with two M4 screws, spring washers, and flat washers. The tightening torque is 1.2 N•m (approximately 12 kgf•cm).

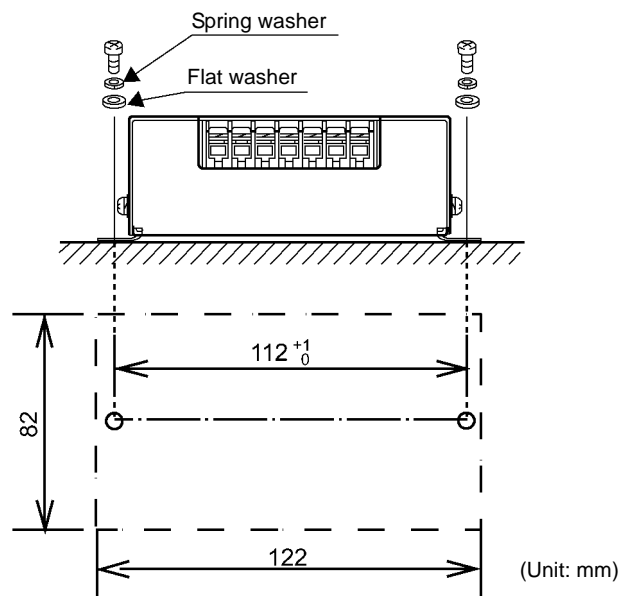

5-3-3 Wiring Link Units

◆ Connecting RS-422A/485 Link Unit Connecting Cable

Connecting:

- (1) Always hold the connector on the Connecting Cable to the Link Unit and insert it into the Link Unit completely.
- (2) When you have inserted the connector into the Link Unit, tighten the two lock screws with a Phillips screwdriver to secure it.
- (3) Attach the enclosed ferrite core to the Connecting Cable. Close the ferrite core and lock it completely.

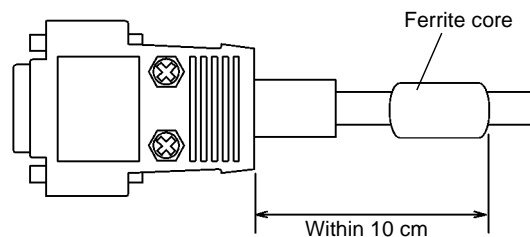

Disconnecting:

- (1) To disconnect the connector, loosen the two lock screws completely and pull the connector out straight, holding the connector hood.
- (2) If the connector is hard to pull out, push the Link Unit while pulling out the connector.

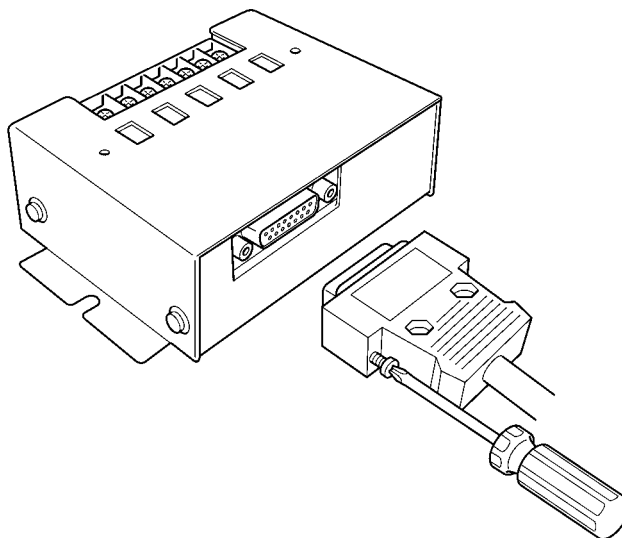

Precaution for Correct Use

Be sure to connect a grounding wire. Otherwise, an error may occur in operation.

Do not touch any terminal when the power supply is ON. Otherwise, an error may occur in operation.

Do not disassemble the Unit or touch the inside when the power supply is turned ON. Otherwise, the Unit may fail.

◆ **Connecting the Power Supply, Ground Wire, and Signal Wires**

M3 screws are used for the power supply, ground, and signal terminals. For crimp terminals, use either one of those listed below. The tightening torque is 0.6 N•m (approximately 6 kgf•cm).

• **Applicable Crimp Terminals**

Applicable wire	Type
AWG22 to AWG16	Forked

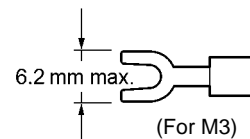

• **Recommended 24 VDC Power Supply**

S82K-01524 (Output: 24 VDC, 0.6 A. Input: 100 to 240 VAC. OMRON)
 UL Class 2 Power Supply

• **Ground GR to 100 Ω or less.**

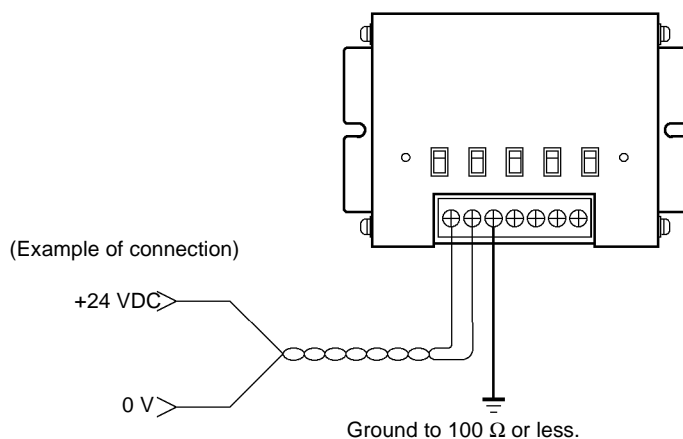

Precaution for Correct Use

If excessive noise is superimposed on the power supply line, supply power through a line filter. A line filter will considerably reduce ground noise.

◆ Connecting Signal Wires

To suppress noise, attach the enclosed ferrite core to the signal lines as shown below.

- (1) Wire the signal wires.
- (2) Put the signal wires together and wind the signal wires round the ferrite core once to prevent the ferrite core from moving. Position the ferrite core within 10 cm from the Link Unit.

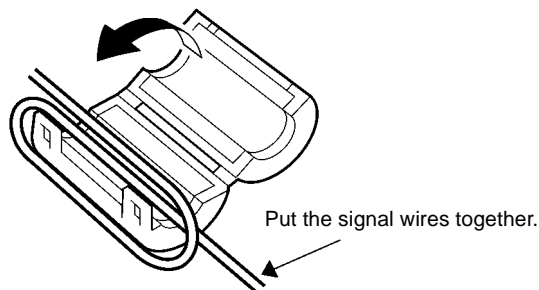

- (3) Close the ferrite core and lock it completely.

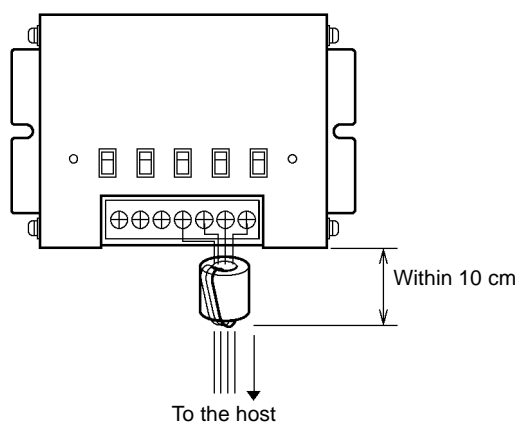

- ◆ After completing wiring, attach the enclosed terminal block cover.

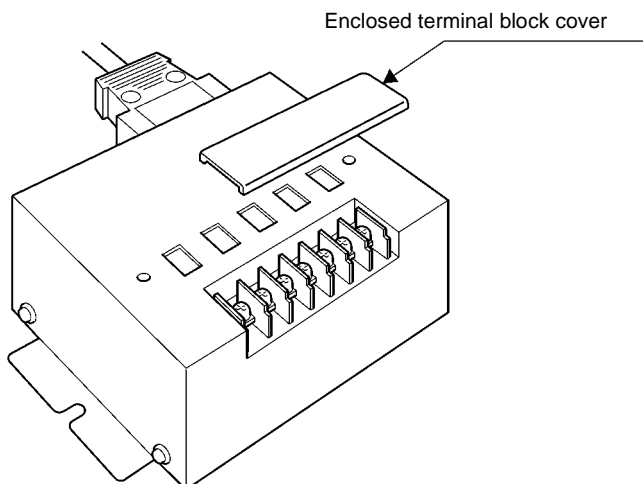

5-3-4 Switch Settings

Turn ON/OFF the switches with the enclosed plastic screwdriver. By default, all the switches are set to OFF or RS-485.

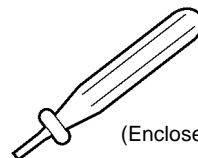

(Enclosed plastic screwdriver)

◆ Enabling Setting Mode (Refer to Section 6-1)

- (1) Turn OFF the ANT PWR switch (A) (see next page).
- (2) Turn ON the SET UP switch (B).
- (3) Turn ON the ANT PWR switch (A). → The ANT PWR indicator will light and setting mode will be enabled.

◆ Enabling Operation Mode (Refer to Section 6-1)

- (1) Turn OFF the ANT PWR switch (A) (see next page).
- (2) Turn ON the SET UP switch (B).
- (3) Turn ON the ANT PWR switch (A). → The indicator ANT PWR will light and operation mode will be enabled.

◆ Enabling RS-422A communications

- (1) Turn OFF the 24 VDC power supply to the Link Unit (see next page).
- (2) Set the RS-422A/RS-485 switch (C) to RS-422A.
- (3) Turn ON or OFF the terminating resistance of RS-422A RD (D) and RS-422A SD (E) as required by the system configuration.
- (4) Connect the signal line terminals.
- (5) Turn ON the 24 VDC power supply to the Link Unit.

◆ Enabling RS-485 Communications

- (1) Turn OFF the 24 VDC power supply to the Link Unit (see next page).
- (2) Set the RS-422A/RS-485 switch (C) to RS-485 to disable RS-422A RD (D).
- (3) Turn ON or OFF the terminating resistance of RS-422A SD (E) as required by the system configuration.
- (4) Connect the signal line terminals.
- (5) Turn ON the 24 VDC power supply to the Link Unit.

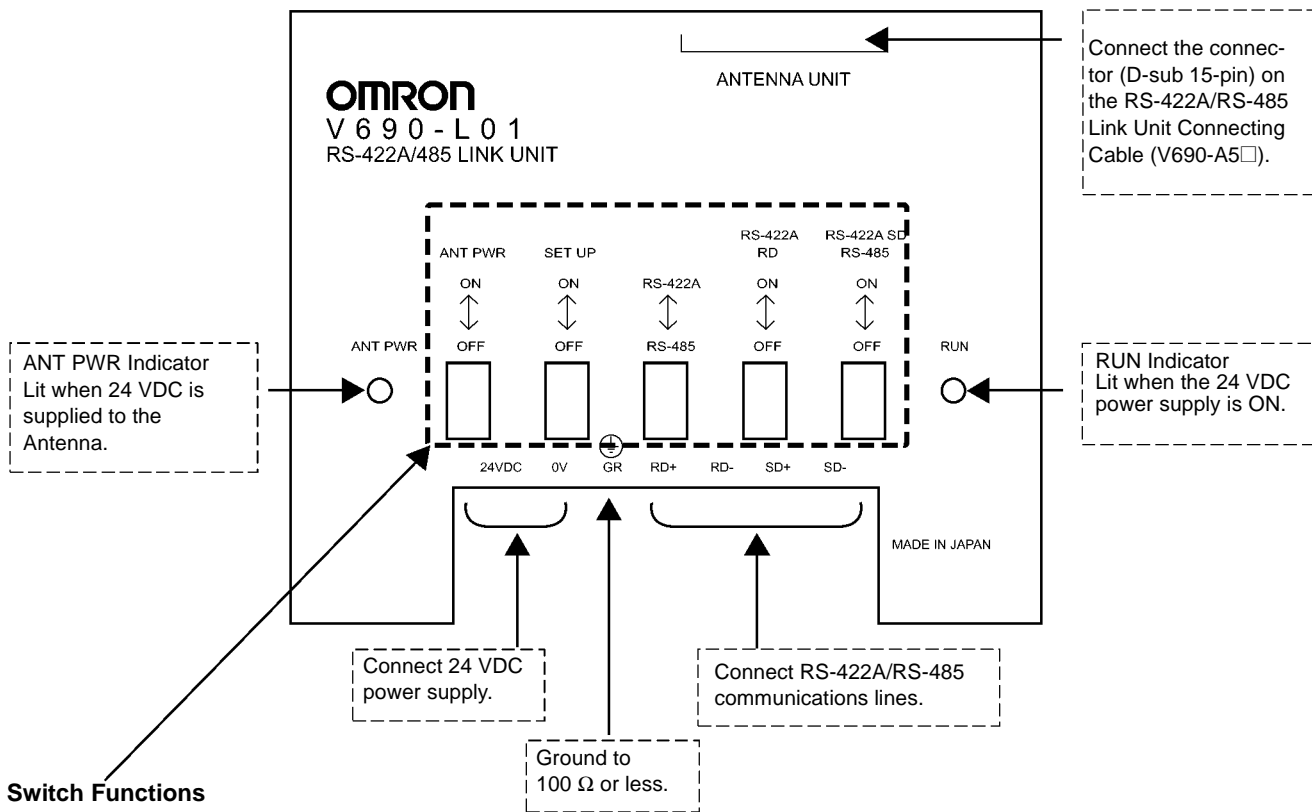

Switch Functions

(A)	(B)	(C)	(D)	(E)
ANT PWR	SET UP	RS-422A/RS-485	RS-422A RD (Receiving)	RS-422A SD (Sending) RS-485

Chapter 6 Controlling Operation from the Host

6-1 Operation Status of Read/Write Antenna and ID Tags

The Antenna in a V690 Series RFID System communicates with a Tag according to commands (1) sent from the host and returns the results to the host as responses (3).

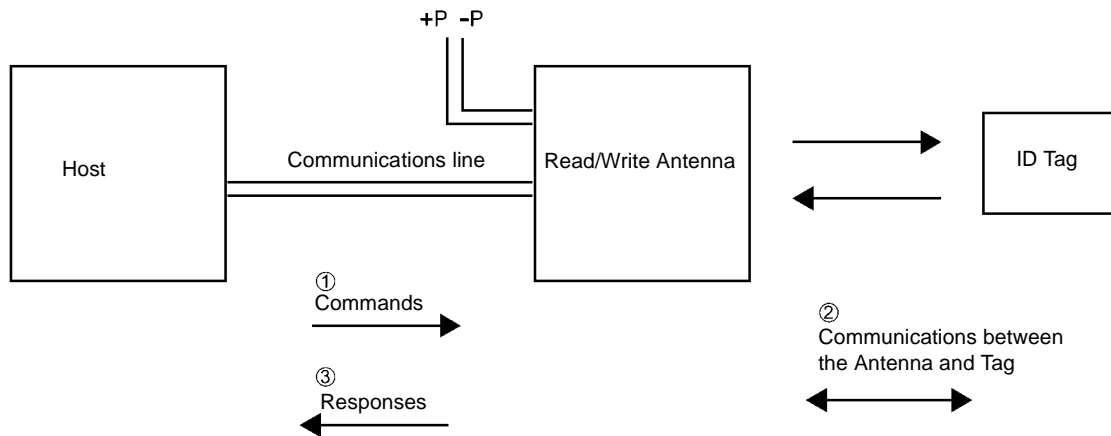

◆ Operation Mode and Setting Mode of Antenna

Two modes are available in the operation of the Antenna. The available commands depend on the mode. Refer to Section 6-4.

Mode	Entering the mode	Description	Host communications	Antenna station number
Operation mode	Disconnect the two Antenna terminals +P and -P and reset the power supply (turn OFF the power supply once and turn it ON again).	Use for normal operation.	Settings can be changed. (Refer to Section 6-9-7.)	00 to 31 (initial value 00)
Setting mode	Short-circuit the two Antenna terminals +P and -P and reset the power supply.	<ul style="list-style-type: none"> A simplified communications function (without connection to the host) is available. Refer to Section 4-4. Tag communications commands and radio wave transmission ON/OFF commands cannot be used. 	Fixed settings. (Refer to Section 6-9-7.) Use when the host communications settings are unknown.	99

◆ Tag Status after Command Execution

Two modes are available after a command has been executed.

Mode	How to change mode	Description
Sleep state	Specify S□ or R□ in the communications designation of the command.	<ul style="list-style-type: none"> Tag battery power can be saved. A Tag cannot be started within 0.2 seconds after entering sleep state. Use for FIFO (First-In First-Out) communications. Refer to (3) of Section 6-2-1.
Standby state	Specify W□ or C□ in the communications designation of the command.	<ul style="list-style-type: none"> Use when several commands are executed consecutively for one Tag.

6-2 Communications Operation Sequences

Operation sequences, such as communications with a Tag and response return timing, depend on the designations made with commands. Designations must be made according to the Tag status in the Antenna communications area and the type of communications with the host.

6-2-1 Communications Modes with Commands

(1) Trigger

With a Trigger command, a communication is performed with the Tag in the Antenna communications area when a command is received. Check that the Tag is in the Antenna communications area before executing the command. If there is no Tag in the Antenna communications area when the command is executed, the Antenna will return an error response.

After the command is executed, the Tag will enter sleep mode or standby mode.

- Sleep Mode (Communications Designation: SU or SN)
The Tag battery power can be saved in sleep mode. The Tag cannot be started within 0.2 seconds after entering sleep state.
- Standby Mode (Communications Designation: WU or WN)
Use the standby mode to execute several commands consecutively for one Tag.

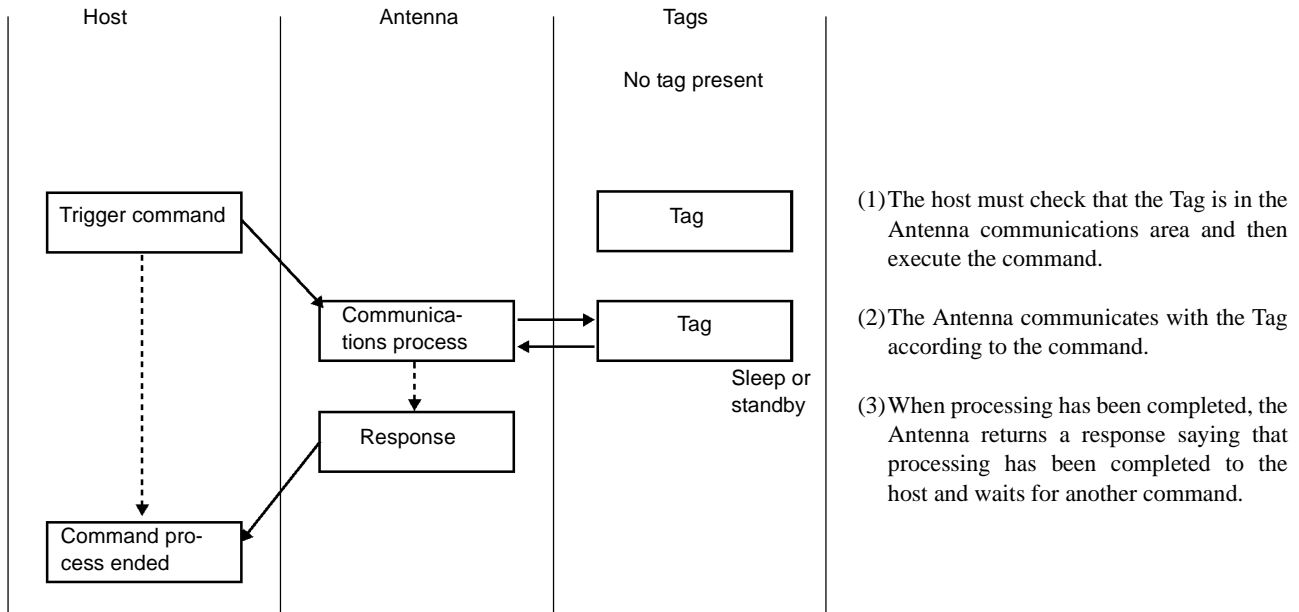

Precaution for Correct Use

In Trigger Mode, always confirm that a Tag is in the Antenna communications area before executing a command.

(2) Single Auto

With a Single Auto command, the Antenna will wait until a Tag enters the communications area and then communicates with the Tag. To end Single Auto Mode, perform one of the following:

- Execute an Auto Repeat Cancel command (C2). The Antenna will leave Single Auto Mode and wait for a command.
- Execute any other command. The Antenna will leave Single Auto Mode and execute the new command. If the command format is wrong, the Antenna will return a format error response of 14 and leave Single Auto Mode.
- If a waiting time is set for a Tag (refer to Section 6-9-4), the Antenna will return a no-Tag error response of 72 and leave Single Auto Mode when the waiting time for the Tag has expired.

After the command is executed, the Tag will enter sleep mode or standby mode.

- Sleep Mode (Communications Designation: SU or SN)
The Tag battery power can be saved in sleep mode. The Tag cannot be started within 0.2 seconds after entering sleep state.
- Standby Mode (Communications Designation: WU or WN)
Use the standby mode to execute several commands consecutively for one Tag.

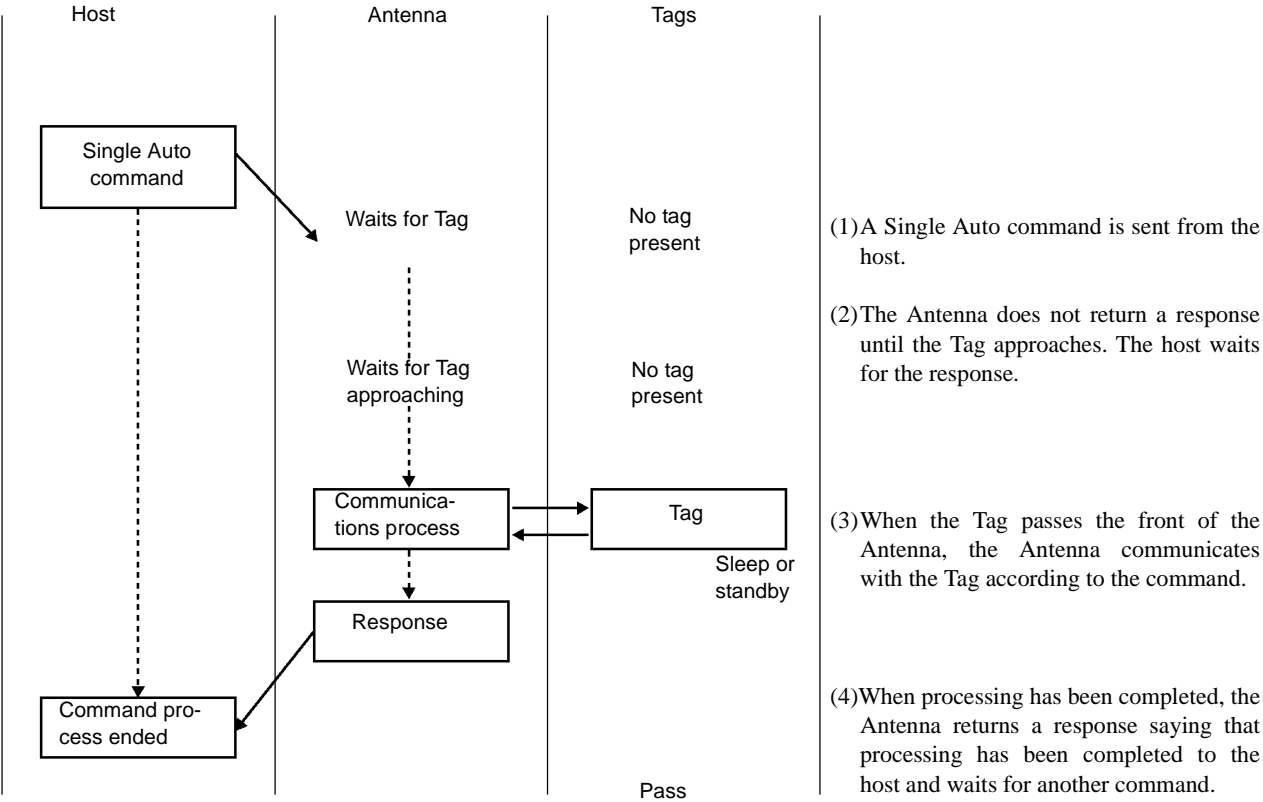

(3) Repeat

When a Repeat command is received by the Antenna from the host, the Antenna will wait for a Tag, communicate with the Tag whenever the Tag enters the Antenna communications area, and return responses to the host.

If the sleep state (S□) is specified in the communications designation when the command is executed, FIFO (First-In First-Out) communications will be performed. (Refer to Section 4-1).

To end Repeat Mode, perform one of the following:

- Execute an Auto Repeat Cancel command (C2). The Antenna will leave Repeat Mode and wait for a command.
- Execute any other command. The Antenna will leave Repeat Mode and execute the new command. If the command format is wrong, the Antenna will return a format error response of 14 and leave Repeat Mode.
- If a waiting time is set for a Tag (refer to Section 6-9-4), the Antenna will return a no-Tag error response of 72 and leave Repeat Mode when the waiting time for the Tag has expired.

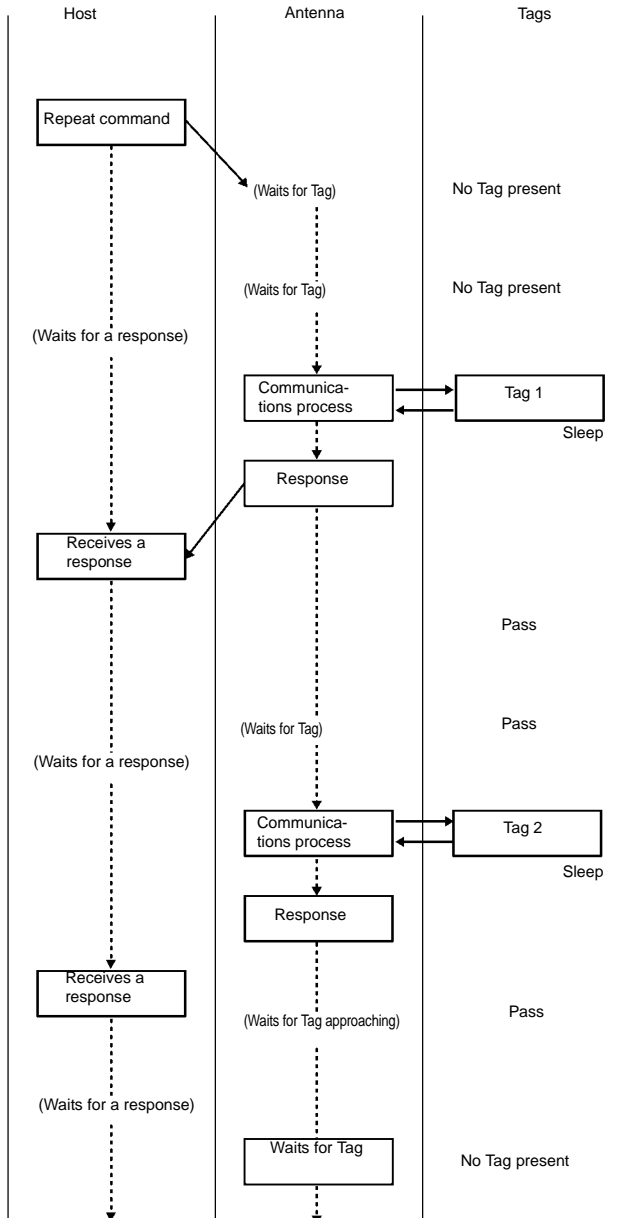

(1) A Repeat command is sent from the host.
 (2) The Antenna does not return a response until the Tag approaches.

(3) When a Tag passes the front of the Antenna, the Antenna communicates with the Tag according to the command.
 (4) When processing has been completed, the Antenna returns a response saying that communication have been completed to the host and waits for another Tag.

(5) When another Tag passes the front of the Antenna, the Antenna communicates with the Tag.
 (6) When processing has been completed, the Antenna returns a response saying that communications have been completed to the host and waits for another Tag.

6-2-2 Communications Modes with Communications Designations

(1) Polling Designation

If a normal auto command is used when one host controls several Antennas, a response is returned when Tag communications have been completed. Several Antennas will return a response. With a Polling designation, the Antenna will return the response only at the request of the host. This prevents more than one response from being returned simultaneously so that several Antennas can be controlled.

To terminate polling, perform one of the following:

- Execute an Auto Repeat Cancel command (C2). The Antenna will discontinue Polling Auto/Polling Repeat and wait for a command.
- Execute any other command. The Antenna will leave the polling mode and execute the new command. If the command format is wrong, the Antenna will return a format error response of 14 and discontinue Polling Auto/Polling Repeat.
- If a waiting time is set for a Tag (refer to Section 6-9-4), the Antenna will return a no-Tag error response of 72 and discontinue Polling Auto when the waiting time for the Tag has expired. For Polling Repeat, the Antenna will return an error response and continue Polling Repeat.

After the command is executed, the Tag will enter sleep mode or standby mode according to the communications designation (C□ or R□).

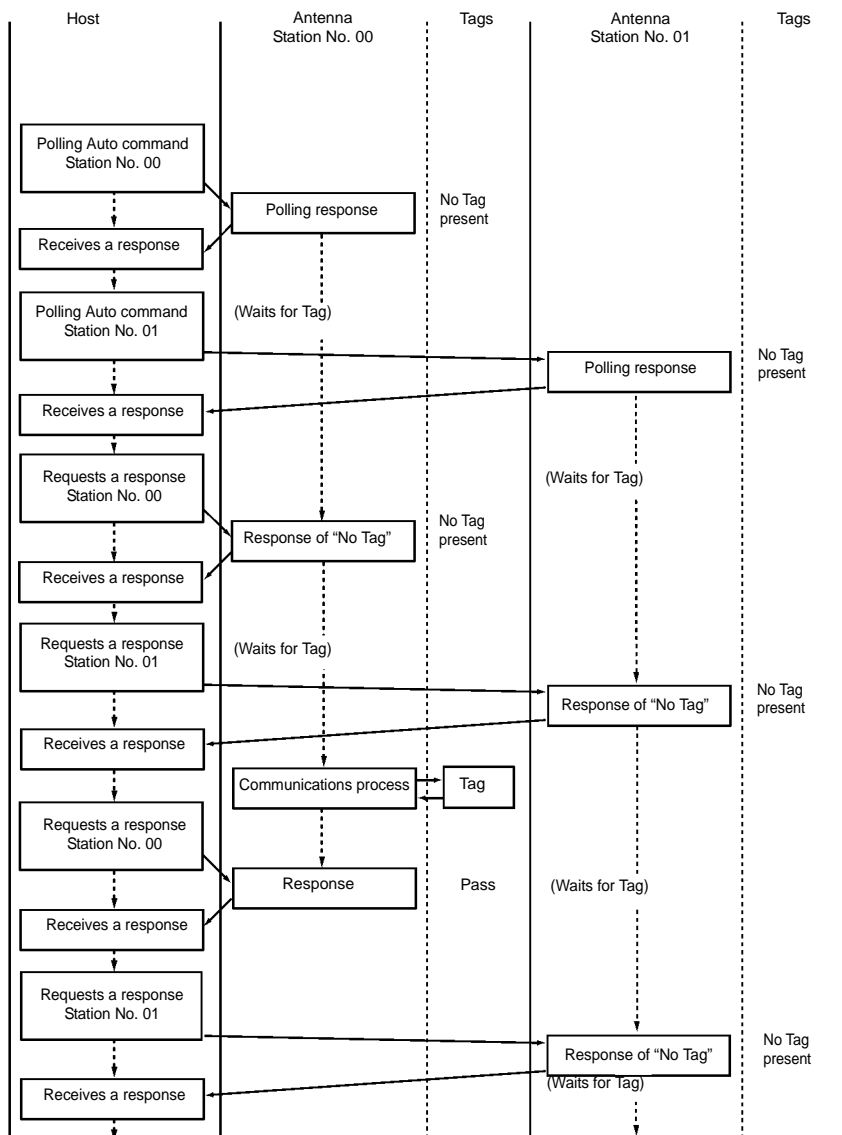

- (1) A Polling Auto command is sent from the host to the Antenna station No. 00.
- (2) Immediately after receiving the command, the Antenna returns a response saying the command has been accepted.
- (3) A Polling Auto command is sent from the host to the Antenna station No. 01.
- (4) Immediately after receiving the command, the Antenna returns a response saying the command has been accepted.
- (5) The host can inquire about the progress of process using a response request. If a Tag has not yet approached, a response of "No Tag" is returned to the response request.
- (6) When a Tag passes the front of the Antenna station No. 00, the Antenna station No. 00 communicates with the Tag.
- (7) When the response request is sent to an Antenna that had completed communications with a Tag, the Antenna returns a response giving the processing results and waits for another command.

(2) Multi

With a Multi command designation, communications can be made with all the Tags in the Antenna communications area. Multi Trigger and Multi Repeat commands are supported.

With a Multi Trigger command, the Antenna communicates with all the Tags in the communications area when it receives a command. When processing has been completed, the Antenna will return a communications end response (end code 72).

With a Multi Repeat command, the Antenna will wait for a Tag after it receives a command. The Antenna continues to communicate with all the Tags entering the communications area.

To terminate Multi Repeat, perform one of the following:

- Execute an Auto Repeat Cancel command (C2). The Antenna will discontinue Multi Repeat and waits for a command.
- Execute any other command. The Antenna will discontinue Multi Repeat and execute the new command. If the command format is wrong, the Antenna will return a format error response of 14 and discontinue Multi Repeat.

If a waiting time is set for a Tag (refer to Section 6-9-4), the Antenna will return a no-Tag error response of 72 and discontinue Multi Repeat when the waiting time for the Tag has expired.

After the command is executed, the Tag will enter sleep mode according to the communications designation (S□).

An example of Multi Trigger is illustrated below.

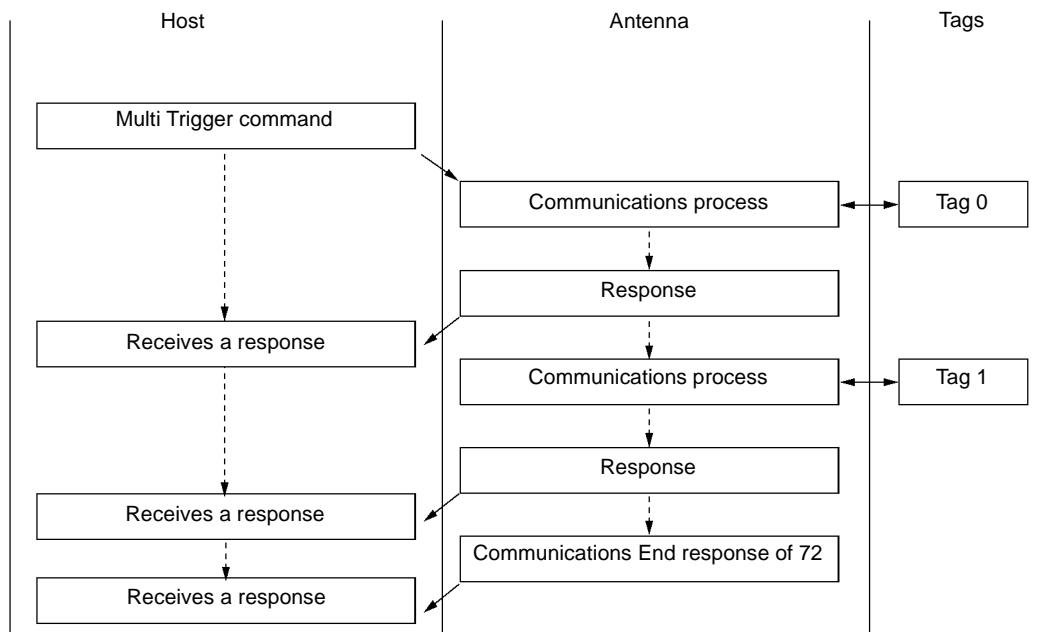

Multi S/M/L

The Time Slot method (refer to Appendix 1 Glossary) is used to detect several Tags. Select S, M, or L to optimize the Multi communications time.

Code	Number of Tags with which to communicate	Number of time slots
S	Approximately 4 Tags	8
M	Approximately 8 Tags	16
L	Approximately 16 Tags	32

6-2-3 Other Communications Modes

(1) Selective Access

Every Tag has an inherent ID code which cannot be rewritten. By using this ID code, communications can be performed with a particular Tag in the Antenna communications area even if more than one Tag is present.

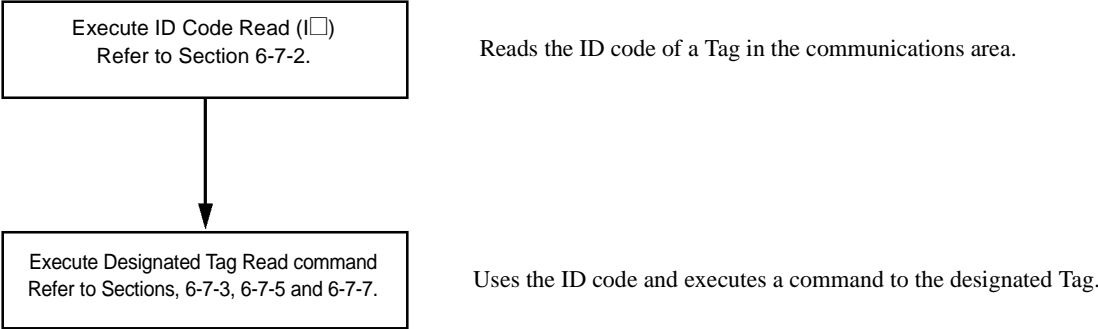

(2) Radio Wave Transmission ON Mode

Usually, an Antenna transmits radio waves after receiving a command from the host. When the Radio Wave Transmission ON Mode of Antenna is enabled, the Antenna will transmit radio waves continuously even if a command is not received from the host. The Radio Wave Transmission ON Mode can be effectively used in applications in which the ID Tag moves quickly.

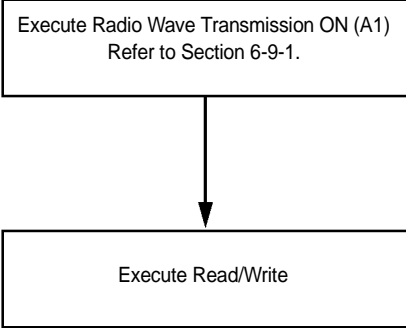

Mode	Initial value	Entering mode	Radio wave transmission status
Radio Wave Transmission OFF Mode	ON		The Antenna does not transmits radio waves while it waits for a command. When the Antenna receives a communications command, the Antenna transmits radio waves and communicates with a Tag. When the communications have ended, the Antenna stops transmitting radio waves.
Radio Wave Transmission ON Mode		Radio Wave Transmission ON (A1) Refer to Section 6-9-1. Switching to the Radio Wave Transmission OFF Mode <ul style="list-style-type: none"> • Radio Wave Transmission OFF command (A0) Refer to Section 6-9-1. • Reset command (C0) Refer to Section 6-9-2. • Reset the power supply. 	The Antenna transmits radio wave continuously even if a command is not received from the Antenna.

6-3 Command and Response Formats

(1) Commands

The text portion of a command consists of the command code and an option section, which specifies additional information. The command is executed only when the Antenna receives all the data from STX to ETX correctly and only when the Antenna station No. and DA match. If the Antenna receives another STX before it receives ETX, the second STX will be taken as the beginning of the command. You can specify whether the BCC is included. By default, BCC is not included. Refer to Section 6-9-7 for information on enabling and disabling the BCC.

- Without BCC *The number of characters is given below each item.

STX	DA	SA	Command code	Option	ETX
1	2	2	2		1

- With BCC

STX	DA	SA	Command code	Option	ETX	BCC
1	2	2	2		1	1

Name	Description
STX	Indicates the beginning of a command or response frame. It corresponds to 02h in the ASCII table.
DA	Destination (Antenna) station number. In operation mode: 00 to 31 (initial value: 00). In setting mode: 99. The station number in operation mode can be changed using the Station Number Setting command.
SA	Source (host) station number 80 to 89. Several hosts can be used. If only one host is used, specify 80.
Command Code	Specifies the command for Antenna operation. For supported command codes, refer to the command list in Section 6-4.
Option	Provides communications specifications for command execution, read data, write data, etc. For details, refer to the formats of individual commands beginning with Section 6-7.
ETX	Indicates the end of a command or response. It corresponds to 03h in the ASCII table.
BCC	Block Check Character (BCC). Calculation result of horizontal parity from immediately after STX to ETX. It is given as one character. For example of calculating the BCC, refer to the next page.

Note: "h" indicates hexadecimal notation.

(2) Responses

The text portion of a response consists of the command code, an end code, and a data section.

- Without BCC *The number of characters is given below each item.

STX	DA	SA	Command code	End code	Data	ETX
1	2	2	2	2		1

- With BCC

STX	DA	SA	Command code	End code	Data	ETX	BCC
1	2	2	2	2		1	1

Name	Description
DA	Destination (host) station number 80 to 89.
SA	Source (Antenna) station number. In operation mode: 00 to 31 (initial value: 00). In setting mode: 99.
Command Code	The command code sent with the command is returned.
End Code	Returns the result of command execution as an end code. For end codes, refer to the end code list in Section 6-10.
Data	Returns a response number, ID code, read data, etc. For details, refer to the formats of individual commands beginning with Section 6-7.

◆ Example of Calculating the BCC

The BCC is used to detect data errors caused by noise in data communications between the host and Antenna. The BCC is one character resulting from an XOR by character of all data that was sent from DA to ETX. For details, refer to JIS5001 *Character Configuration on Transmission Line and Horizontal Parity Usage*.

An example of calculations is given below.

Example: ID Code Read, Single Trigger

Data Name	STX	DA	SA	Command Code	Communications Designation		ETX	BCC
Data	02h	"00"	"80"	"13"	"W"	"U"	03h	73h

Note: "h" indicates hexadecimal notation.

DA	0	0011		0000
			XOR	
	0	0011		0000
			XOR	
SA	8	0011		1000
			XOR	
	0	0011		0000
			XOR	
Command Code	I	0100		1001
			XOR	
	3	0011		0011
			XOR	
Communications Designation	W	0101		0111
			XOR	
	U	0101		0101
			XOR	
ETX	03H	0000		0011
		0111		0011
		7h		3h

6-4 Commands and Communications Designations

There are three types of commands as follows:

- (1) Tag communications commands: A command to communicate with a Tag
- (2) Antenna operation commands: A command to control the Antenna when communicating with a Tag.
- (3) Antenna setting commands: A command to set the Antenna before operating a system.

(1) Tag Communications Commands

Use these commands when the Antenna is in operation mode. They cannot be used in setting mode. Refer to Section 6-1.

Commands

Command	Communications mode (Section 6-2-1)	Command code	Function
Read (Section 6-7-1 and 6-7-3)	Trigger	R3	Reads data, write protection settings, date of production, and the waiting time for sleeping.
	Single Auto	R6	
	Repeat	R9	
ID Code Read (Section 6-7-2)	Trigger	I3	Reads the ID code of a Tag. *The ID code is a value inherent to a Tag and cannot be changed.
	Single Auto	I6	
	Repeat	I9	
Write Without Verification (Section 6-7-4 and 6-7-5)	Trigger	W3	Writes data, write protection settings, and the waiting time for sleeping.
	Single Auto	W6	
	Repeat	W9	
Write With Verification (Section 6-7-4 and 6-7-5)	Trigger	W1	Writes data, write protection settings, and the waiting time for sleeping. Reads and checks write data after writing.
	Single Auto	W4	
	Repeat	W7	
Data Fill (Section 6-7-6 and 6-7-7)	Trigger	F3	Writes specific data into a specified range of memory. For example, memory can be cleared by writing 0 into all areas in memory.
	Single Auto	F6	
	Repeat	F9	
Communications Test (Section 6-7-8)	Trigger	T0	Communications test between the Antenna and a Tag.

Communications Designations

Direct response/Polling ((1) in Section 6-2-2)	One Tag/Multi (several Tags)/Designated Tag ((2) in Section 6-2-2 and (1) in Section 6-2-3)	Tag status after command execution (Section 6-1)	Communications designation	
			(1)	(2)
Direct response	One Tag	Sleep	S	U
Direct response	One Tag	Standby	W	U
Polling	One Tag	Standby	C	U
Direct response	Multi (several Tags)	Sleep	S	S/M/L
Polling	Multi (several Tags)	Sleep	R	S/M/L
Direct response	Designated Tag	Sleep	S	N
Direct response	Designated Tag	Standby	W	N

* **Direct response:** A communications mode in which a command is received from the host and a response is made immediately after command execution.

Communications designation (1)	W: Direct response. The Tag after execution is placed in standby state. S: Direct response. The Tag after execution is placed in sleep state. C: Polling. The Tag after execution is placed in standby state. R: Polling. The Tag after execution is placed in sleep state.
Communications designation (2)	U: One Tag access without ID code designation. N: One Tag access with ID code designation. S/M/L: Multi Tag access.

Multi Tag Access S/M/L

The time slot method is used to detect several Tags. Select S/M/L to minimize the communications time for Multi. (Even if the number specified in S/M/L and the number of actual Tags do not match, Multi communications can be made. However, it may take a long time to communicate.)

Symbol	Number of Tags in communications area at one time	Number of time slots
S	Approximately 4 Tags	8
M	Approximately 8 Tags	16
L	Approximately 16 Tags	32

(2) Antenna Operation Commands

Any command that controls the Antenna is executed immediately.

Command name (Referred item)	Command code	Operation mode	Setting mode	Function
Auto Repeat Cancel (Section 6-8-1)	C2	Enabled		Cancels and discontinues Auto and Repeat commands.
Reset (Section 6-8-2)	C0		Enabled	<ul style="list-style-type: none"> • Clears data read from a Tag by polling. A response will not be returned for a Request to Response (H0) command. • Clears the immediately preceding response. A response will not be returned to a Request To Retransmit (H1) command. • Disables the Radio Wave Transmission ON Mode. • Enables the host communications condition setting and station number setting commands.
Request to Respond (Section 6-8-3)	H0			Requests a response from a Tag during polling operation.
Request to Retransmit (Section 6-8-4)	H1		Enabled	Requests to retransmit the immediately preceding response.

(3) Antenna Setting Commands

Any command that sets the Antenna is executed immediately.

Command name (Referred item)		Operation mode	Setting mode	After resetting power supply or executing reset	Function	Initial value
Radio Wave Transmission OFF (Section 6-9-1)	A0	Enabled	Disabled	No change in the radio wave OFF mode.	Sets the radio wave transmission OFF mode.	OFF mode
Radio Wave Transmission ON (Section 6-9-1)	A1			Returns to the radio wave OFF mode.	Sets the radio wave ON mode.	
Communications Range Selection (Section 6-9-2)	A4		Enabled	Setting before resetting does not change.	Sets the output power mode (communications range) to low-power (2 m) or high-power (5 m) mode.	Low-power (2 m) mode
Radio Wave Channel Selection (Section 6-9-2)	A5				Sets the radio wave channel (0 to 9).	5 (2,450 MHz)
Radio Wave Output Status Read (Section 6-9-3)	A6				Reads the power output mode (communications range) and radio wave channel.	
Setting of Time to Wait Tag (Section 6-9-4)	T4				Sets the waiting time for communications with a Tag after command execution when executing an Auto or Repeat command.	Unlimited
Command Data Response Time Setting (Section 6-9-5)	H4				Sets the command response time and data response time interval.	10 ms 10 ms
Read Data Length Setting (Section 6-9-6)	H3				Sets the maximum data length that can be returned in one response for a data read command.	256 bytes
Host Communications Condition Setting (Section 6-9-7)	H5				Enabled (Note 1)	Sets the conditions for communications with the host.
Station Number Setting (Section 6-9-8)	H6		Sets the Antenna station number.	00		
Setting Read (Section 6-9-9)	M2		Disabled	Reads the Antenna setting values.		

Note 1. To enable changes made using the Host Communications Condition Setting or Station Number Setting command, execute a reset command (Section 6-8-2) or reset the power supply after executing the command.

Note 2. 9.6 kbps, data length: 7 bits, even parity, stop bits: 2, no BCC. (Refer to Section 6-9-7)

Laws and Standards
<ul style="list-style-type: none"> • Always use the low-power (2 m) mode when using the Antenna in the USA. • Always use radio wave channel 5 when using the Antenna in Iceland, Ireland, England, Italy, Austria, the Netherlands, Greece, Switzerland, Spain, Denmark, Norway, Finland, France, Belgium, or Luxembourg.

6-5 Data Code Designation

You can specify the type of code used to transmit data to be read or written between the host and Read/Write Antenna. ASCII and hexadecimal designations are supported.

◆ ASCII (JIS 8-bit Code): Code Designation A

One byte of data for a Tag is transmitted directly as ASCII or JIS 8-bit code. One transmitted character is equal to a 1 byte of data in the Tag. Character data can be read/written directly.

Do not use any control codes, such as [SOH] or [CR], in transmission data. Otherwise, a command error will occur.

Writing Example 1

In the data shown here, “OMRON” is specified as write data for 5 bytes of memory beginning with 10h, and the data is written into Tag memory as shown below.

Command

ASCII designation

STX	DA	SA	Command code	Communications designation	Split flag	Code designation	Start address	Number of write bytes	Write data	ETX
	00	80	W1	SU	A	A	0010	0005	OMRON	

Response

STX	DA	SA	Command code	End code	Response number	ID code	ETX
	80	00	W1	00	01	*****	

Address	Tag Memory		
10h	4	F	“0”
11h	4	D	“M”
12h	5	2	“R”
13h	4	F	“0”
14h	4	E	“N”

Reading Example 1

In the data shown here, 5 bytes of memory beginning with 10h is read out, and the read data is “OMRON”.

Command

STX	DA	SA	Command code	Communications designation	Split flag	Code designation	Start address	Number of read bytes	ETX
	00	80	R3	SU	A	A	0010	0005	

Response

STX	DA	SA	Command code	End code	Response number	ID code	Split flag	Code designation	Start address	Number of read bytes	Number of read data	ETX
	80	00	R3	00	01	*****	A	A	0010	0005	OMRON	

Writing Example 2

In the data shown here, “1234” is specified as write data for 4 bytes of memory beginning with 10h, and the data is written into Tag memory as shown below.

Command

ASCII designation

STX	DA	SA	Command code	Communications designation	Split flag	Code designation	Start address	Number of write bytes	Write data	ETX
	00	80	W1	SU	A	A	0010	0004	1234	

Response

STX	DA	SA	Command code	End code	Response number	ID code	ETX
	80	00	W1	00	01	*****	

Address	Tag Memory		
10h	3	1	“1”
11h	3	2	“2”
12h	3	3	“3”
13h	3	4	“4”

Reading Example 2

In the data shown here, 4 bytes of memory beginning with 10h is read out, and the read data is “1234”.

Command

STX	DA	SA	Command code	Communications designation	Split flag	Code designation	Start address	Number of read bytes	ETX
	00	80	R3	SU	A	A	0010	0004	

Response

STX	DA	SA	Command code	End code	Response number	ID code	Split flag	Code designation	Start address	Number of read bytes	Read data	ETX
	80	00	R3	00	01	*****	A	A	0010	0004	1234	

◆ **Hexadecimal: Code Designation H**

One byte of data in the Tag is converted into two hexadecimal numbers (00 to FF) and those numbers are transmitted. Two transmitted characters are equal to 1 byte of data in the Tag. Be sure to specify write data in two hexadecimal numbers from 00 to FF (even). If an odd number of data is specified, a command error will occur.

Writing Example

In the data shown here, “1234” is specified as write data for 2 bytes of memory beginning with 20h, and data is written into Tag memory as shown below.

Command

STX	DA	SA	Command code	Communications designation	Split flag	Code designation	Start address	Number of write bytes	Write data	ETX
	00	80	W1	SU	A	H	0020	0002	1234	

Hexadecimal designation

Response

STX	DA	SA	Command code	End code	Response number	ID code	ETX
	80	00	W1	00	01	*****	

Address	Tag Memory	
20h	1	2
21h	3	4

Reading Example

In this data shown here, 2 bytes of memory beginning with 20h is read out, and the read data is “1234”.

Command

STX	DA	SA	Command code	Communications designation	Split flag	Code designation	Start address	Number of read bytes	ETX
	00	80	R3	SU	A	H	0020	0002	

Response

STX	DA	SA	Command code	End code	Response number	ID code	Split flag	Code designation	Start address	Number of read bytes	Number of read data	ETX
	80	00	R3	00	01	*****	A	H	0020	0002	1234	

6-6 Communications Response Flow

Depending on the command and the communications designation, the command transmission from the host to an Antenna and the response from the Antenna to the host vary.

(1) No Response

When the host sends a reset command to the Antenna, the Antenna does not send any response, resets itself, and waits for a command.

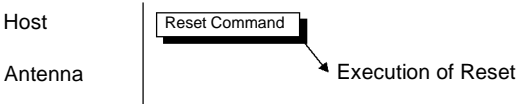

(2) One to One

When the host sends a Single Trigger or Single Auto Tag communications command, or when the host sends an Antenna operation command or Antenna setting command, the Antenna returns one response per command.

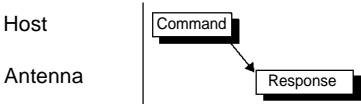

(3) Several Responses

When the host sends a Single Repeat, Multi Trigger, or Multi Repeat, the Antenna returns several responses per command.



6-7 Tag Communications Commands

6-7-1 Read

Reads data from a Tag.

Command Format (The number of characters for each item is given beneath it.)

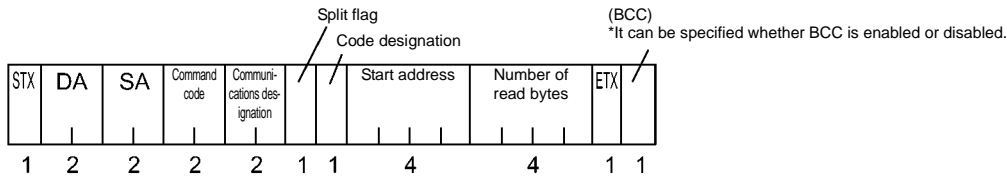

DA	Destination (Antenna) station number: 00 to 31. This can be modified in 6-9-8 Setting the Station Number.	Initial value: 00
SA	Source (host) station number: 80 to 89. If only one host is used, specify 80.	
Command code	Specify according to the following table.	
Communications designation		
Split flag	Specify "A".	
Code designation	Specify whether data read out of a Tag is ASCII or hexadecimal. A: ASCII H: Hexadecimal	
Start address	Specify according to the following table.	
Number of read bytes		

Command Codes and Communications Designations

Command	Tag status after execution	Command code	Communi- cations designa- tion	Remarks
Single Trigger	Sleep	R3	SU	
Single Trigger	Standby		WU	Another command can be executed for the same Tag immediately.
Multi Trigger (approximately 4 Tags)	Sleep		SS	
Multi Trigger (approximately 8 Tags)			SM	
Multi Trigger (approximately 16 Tags)			SL	
Single Auto	Sleep	R6	SU	
Single Auto	Standby		WU	Another command can be executed for the same Tag immediately.
Polling Single Auto			CU	
Single Repeat	Sleep	R9	SU	FIFO
Multi Repeat (approximately 4 Tags)			SS	
Multi Repeat (approximately 8 Tags)			SM	
Multi Repeat (approximately 16 Tags)			SL	
Polling Single Repeat			RU	For the Request To Respond command for polling, refer to 6-8-3 Request to Respond.
Polling Multi Repeat (approximately 4 Tags)			RS	
Polling Multi Repeat (approximately 8 Tags)			RM	
Polling Multi Repeat (approximately 16 Tags)			RL	

Start Address and Number of Read Bytes

Read content	Start address	Number of read bytes	
		ASCII	Hexadecimal
Data	Reading start address (0000 to 1FFF) *Hexadecimal	Specify the number of read bytes (0001 to 2000) *Hexadecimal	Specify the number of read bytes (0001 to 2000) *Hexadecimal
Write protection settings	"WPRO"	(Not supported)	0004 *Refer to Section 4-6.
Date of production	"DATE"	0008 *Refer to Section 3-2-3.	
Waiting time for sleeping	"SLEP"	0004 *Refer to Section 4-7.	

Response Format (The number of characters for each item is given beneath it.)

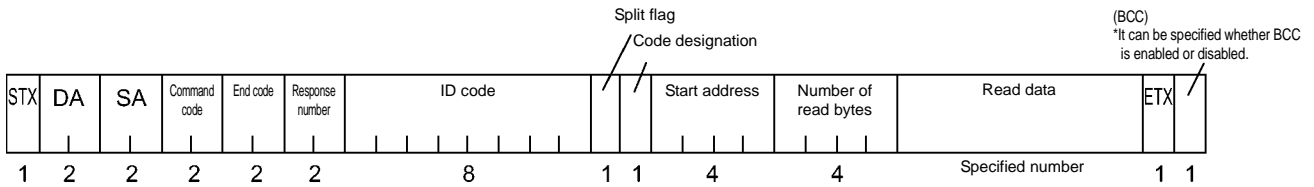

DA	Destination (host) station number. *In the command format, the destination is the Antenna.
SA	Source (Antenna) station number.
End code	00: Normal end. For other end codes, refer to 6-10 End Code List.
Response number	Consecutive number of responses from the Tag. For one response, only 01. For several responses, 02 or higher.
ID code	ID code of Tag. This is inherent to the Tag and cannot be rewritten.
Split flag	The data read length can be set in the Antenna (Refer to Section 6-9-6). The initial value is 256 bytes. <ul style="list-style-type: none"> • If number of read bytes ≤ data read length, the flag is "A". • If number of read bytes > data read length, the data is divided and sent to the host using several responses. "T" is set for the start of data, "C" for data continuations, and "E" for final data.
Read data	Data read out of the Tag. The number of characters of data is as follows: ASCII specified: Number of read bytes Hexadecimal specified: Number of read bytes x 2

Polling Response Format (The number of characters for each item is given beneath it.)

Response immediately after a polling command is sent.

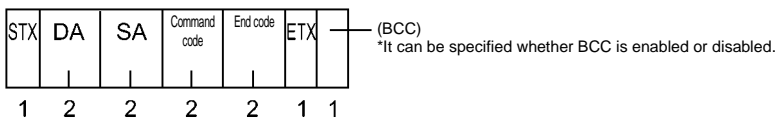

End code	Always 00.
----------	------------

Precaution for Correct Use

For the available number of read bytes, check the ID Tag memory capacity.

6-7-2 ID Code Read

Reads the ID code from a Tag. The ID code is inherent to a Tag and cannot be rewritten.

Command Format (The number of characters for each item is given beneath it.)

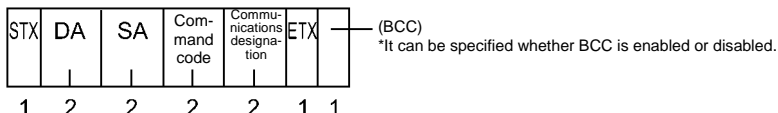

DA	Destination (Antenna) station number: 00 to 31. This can be modified in 6-9-8 Setting the Station Number.	Initial value: 00
SA	Source (host) station number: 80 to 89. If only one host is used, specify 80.	
Command code	Specify according to the following table.	
Communications designa- tion		

Command Codes and Communications Designations

Command	Tag status after execution	Com- mand code	Communi- cations des- ignation	Remarks
Single Trigger	Sleep	13	SU	
Single Trigger	Standby		WU	Another command can be executed for the same Tag immediately.
Multi Trigger (approximately 4 Tags)	Sleep		SS	
Multi Trigger (approximately 8 Tags)			SM	
Multi Trigger (approximately 16 Tags)			SL	
Single Auto	Sleep	16	SU	
Single Auto	Standby		WU	Another command can be executed for the same Tag immediately.
Polling Single Auto			CU	
Single Repeat	Sleep	19	SU	FIFO
Multi Repeat (approximately 4 Tags)			SS	
Multi Repeat (approximately 8 Tags)			SM	
Multi Repeat (approximately 16 Tags)			SL	
Polling Single Repeat			RU	For the Request To Respond com- mand for polling, refer to 6-8-3 Request to Respond.
Polling Multi Repeat (approximately 4 Tags)			RS	
Polling Multi Repeat (approximately 8 Tags)			RM	
Polling Multi Repeat (approximately 16 Tags)			RL	

Response Format (The number of characters for each item is given beneath it.)

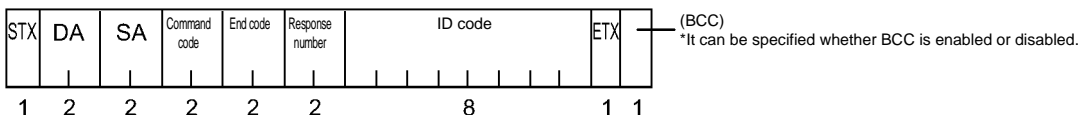

DA	Destination (host) station number. *In the command format, the destination is an Antenna.
SA	Source (Antenna) station number.
End code	00: Normal end. For other end codes, refer to 6-10 End Code List.
Response number	Consecutive number of responses from the Tag. For one response, only 01. For several responses, 02 or higher.
ID code	ID code of Tag. This is inherent to the Tag and cannot be rewritten.

Polling Response Format (The number of characters for each item is given beneath it.)

Response immediately after a polling command is sent.

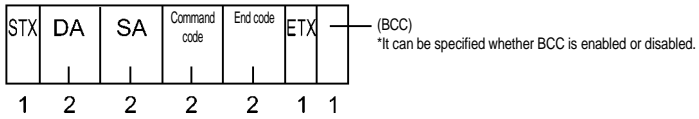

End code	Always 00.
----------	------------

6-7-3 Designated Tag Read

Reads data from a particular ID Tag.

Command Format (The number of characters for each item is given beneath it.)

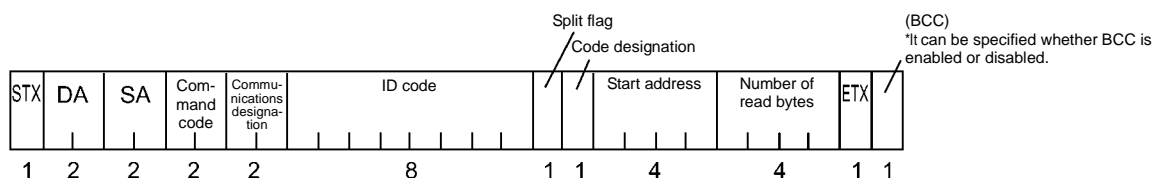

DA	Destination (Antenna) station number: 00 to 31. This can be modified in 6-9-8 Setting the Station Number.	Initial value: 00
SA	Source (host) station number: 80 to 89. If only one host is used, specify 80.	
Command code	R3: Single Trigger	
Communications designation	Gives the communications designation for a Tag. SN: The Tag will enter sleep state after execution. WN: The Tag will enter standby state after execution.	
ID code	Specify the ID code of a particular Tag.	
Split flag	Specify "A".	
Code designation	Specify whether data read out of a Tag is ASCII or hexadecimal. A: ASCII H: Hexadecimal	
Start address	Specify according to the following table.	
Number of read bytes		

Start Address and Number of Read Bytes

Read content	Start address	Number of read bytes	
		ASCII	Hexadecimal
Data	Reading start address (0000 to 1FFF) *Hexadecimal	Specify the number of read bytes (0001 to 2000) *Hexadecimal	Specify the number of read bytes (0001 to 2000) *Hexadecimal
Write protection settings	"WPRO"	Unavailable	0004 *Refer to Section 4-6.
Date of production	"DATE"	0008 *Refer to Section 3-2-3.	
Waiting time for sleeping	"SLEP"	0004 *Refer to Section 4-7.	

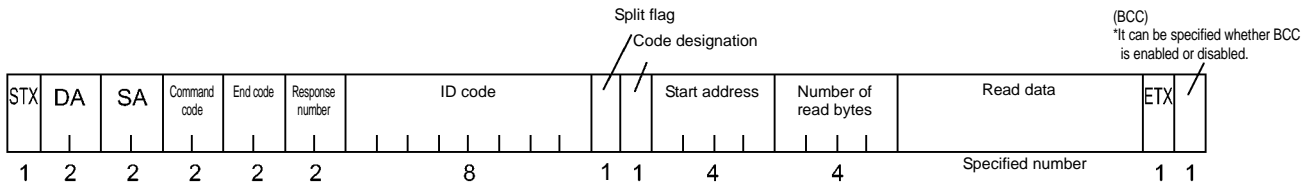
Response Format (The number of characters for each item is given beneath it.)

DA	Destination (host) station number. *In the command format, the destination is an Antenna.
SA	Source (Antenna) station number.
End code	00: Normal end. For other end codes, refer to 6-10 End Code List.
Response number	Always 01.
Split flag	<p>The data read length can be set in the Antenna (Refer to Section 6-9-6). The initial value is 256 bytes.</p> <ul style="list-style-type: none"> • If number of read bytes ≤ data read length, the flag is "A". • If number of read bytes > data read length, the data is divided and sent to the host using several responses. <p>"T" is set for the start of data, "C" for data continuations, and "E" for final data.</p>
Read data	<p>Data read out of the Tag. Number of characters of data is as follows:</p> <p>ASCII specified: Number of read bytes</p> <p>Hexadecimal specified: Number of read bytes x 2</p>

Precautions for Correct Use

- Before executing this command, you need to use the ID Code Read command (I□) to check the ID code of the Tag.
- For the available number of read bytes, check the ID Tag memory capacity.

6-7-4 Write

Writes data into a Tag.

Command Format (The number of characters for each item is given beneath it.)

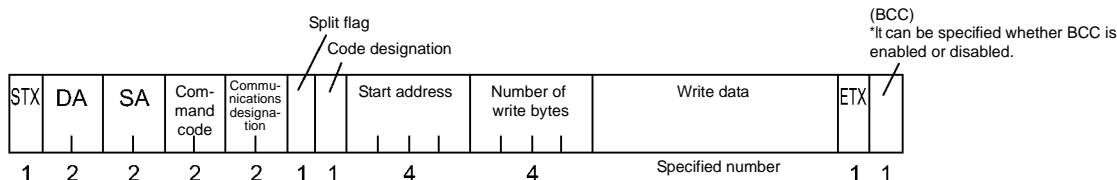

DA	Destination (Antenna) station number: 00 to 31. This can be modified in 6-9-8 Setting the Station Number.	Initial value: 00
SA	Source (host) station number: 80 to 89. If only one host is used, specify 80.	
Command code	Specify according to the following table.	
Communications designation		
Split flag	Specify "A".	
Code designation	Specify whether the data written to the Tag is ASCII or hexadecimal. A: ASCII H: Hexadecimal	
Start address	Specify according to the following table.	
Number of write bytes		

Command Codes and Communications Designations

Command	Tag status after execution	Command code	Communications designation	Remarks
Single Trigger	Sleep	W1 W3	SU	Another command can be executed for the same Tag immediately.
Single Trigger	Standby		WU	
Multi Trigger (approximately 4 Tags)	Sleep		SS	
Multi Trigger (approximately 8 Tags)			SM	
Multi Trigger (approximately 16 Tags)			SL	
Single Auto	Sleep	W4 W6	SU	Another command can be executed for the same Tag immediately.
Single Auto	Standby		WU	
Polling Single Auto			CU	
Single Repeat	Sleep	W7 W9	SU	FIFO
Multi Repeat (approximately 4 Tags)			SS	
Multi Repeat (approximately 8 Tags)			SM	
Multi Repeat (approximately 16 Tags)			SL	
Polling Single Repeat			RU	For the Request To Respond command for polling, refer to 6-8-3 Request to Respond.
Polling Multi Repeat (approximately 4 Tags)			RS	
Polling Multi Repeat (approximately 8 Tags)			RM	
Polling Multi Repeat (approximately 16 Tags)			RL	

With verification read	W1, W4, W7	After the Antenna writes data into the Tag, the Antenna reads the data from the Tag and checks whether the data is correct. If the data is not correct, the end code will be 71. Writing is more reliable, but the communications time with a verification read is twice as long as that without a verification read.
Without verification read	W3, W6, W9	The Antenna does not read the data after the Antenna writes data to the Tag.

Start Address and Number of Read Bytes

Written content	Start address	Number of write bytes	
		ASCII	Hexadecimal
Data	Reading start address (0000 to 1FFF) *Hexadecimal	Specify the number of write bytes (0001 to 2000) *Hexadecimal	Specify the number of write bytes (0001 to 1000) *Hexadecimal
Write protection settings	“WPRO”	Unavailable	0004 *Refer to Section 4-6.
Waiting time for sleeping	“SLEP”	0004 *Refer to Section 4-7.	

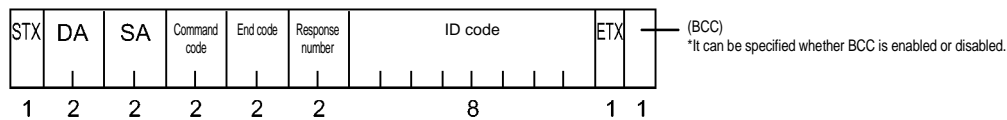
Response Format (The number of characters for each item is given beneath it.)

DA	Destination (host) station number. *In the command format, the destination is an Antenna.
SA	Source (Antenna) station number.
End code	00: Normal end. For other end codes, refer to 6-10 End Code List.
Response number	Consecutive number of responses from the Tag. For one response, only 01. For several responses, 02 or higher.
ID code	ID code of Tag. This is inherent to the Tag and cannot be rewritten.

Polling Response Format (The number of characters for each item is given beneath it.)

Response immediately after a polling command is sent.

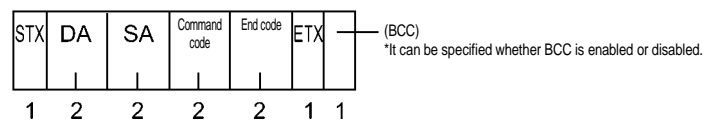

End code	Always 00.
----------	------------

Precaution for Correct Use

For the available number of write bytes, check the ID Tag memory capacity.

6-7-5 Designated Tag Write

Writes data into a particular ID Tag.

Command Format (The number of characters for each item is given beneath it.)

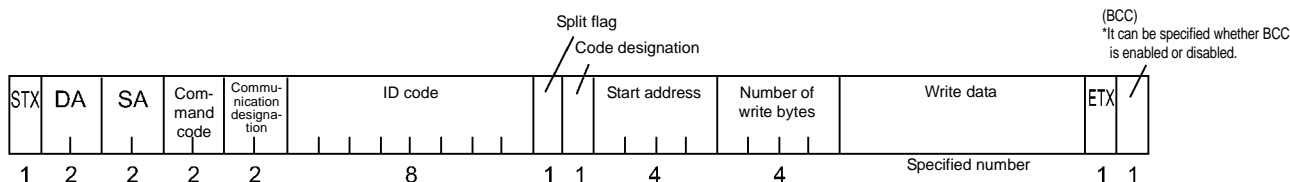

DA	Destination (Antenna) station number: 00 to 31. This can be modified in 6-9-8 Setting the Station Number.	Initial value: 00
SA	Source (host) station number: 80 to 89. If only one host is used, specify 80.	
Command code	W1: Single Trigger, with verification read W3: Single Trigger, without verification read *For information on the verification read, refer to Section 6-7-4.	
Communications designation	Gives communications designation to a Tag. SN: The Tag will enter sleep state after execution. WN: The Tag will enter standby state after execution.	
ID code	Specify an ID code of a particular Tag.	
Split flag	Specify "A".	
Code designation	Specify whether data read out of a Tag is ASCII or hexadecimal. A: ASCII H: Hexadecimal	
Start address	Specify according to the following table.	
Number of write bytes		

Start Address and Number of Read Bytes

Written content	Start address	Number of write bytes	
		ASCII	Hexadecimal
Data	Reading start address (0000 to 1FFF) *Hexadecimal	Specify the number of write bytes (0001 to 2000) *Hexadecimal	Specify the number of write bytes (0001 to 1000) *Hexadecimal
Write protection settings	"WPRO"	Unavailable	0004 *Refer to Section 4-6.
Waiting time for sleeping	"SLEP"	0004 *Refer to Section 4-7.	

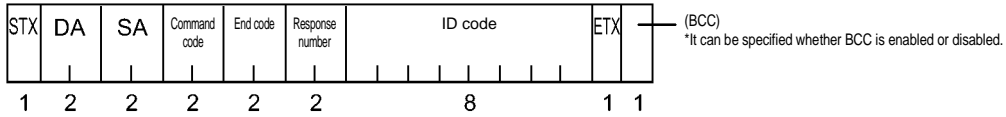
Response Format (The number of characters for each item is given beneath it.)

DA	Destination (host) station number. *In the command format, the destination is an Antenna.
SA	Source (Antenna) station number.
End code	00: Normal end. For other end codes, refer to 6-10 End Code List.
Response number	Always 01.
ID code	ID code of Tag. This is inherent to the Tag and cannot be rewritten.

Precaution for Correct Use

For the available number of write bytes, check the ID Tag memory capacity.

6-7-6 Data Fill

Writes the same data to a specified area of a Tag.

Command Format (The number of characters for each item is given beneath it.)

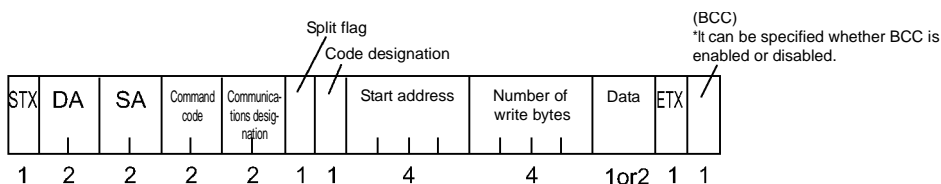

DA	Destination (Antenna) station number: 00 to 31. This can be modified in 6-9-8 Setting the Station Number.	Initial value: 00
SA	Source (host) station number: 80 to 89. If only one host is used, specify 80.	
Command code	Specify according to the following table.	
Communications designation		
Split flag	Specify "A".	
Code designation	Specify whether data read out of a Tag is ASCII or hexadecimal. A: ASCII H: Hexadecimal	
Start address	Specify according to the following table.	
Number of read bytes		
Data	If the code designation is ASCII, one character. If the code designation is hexadecimal, two characters.	

Command Codes and Communications Designations

Command	Tag status after execution	Command code	Communications designation	Remarks
Single Trigger	Sleep	F3	SU	
Single Trigger	Standby		WU	Another command can be executed for the same Tag immediately
Single Auto	Sleep	F6	SU	
Single Auto	Standby		WU	Another command can be executed for the same Tag immediately
Polling Single Auto			CU	
Single Repeat	Sleep	F9	SU	FIFO
Polling Single Repeat			RU	For the Request To Respond command for polling, refer to 6-8-3 Request to Respond.

Start Address and Number of Read Bytes

Read content	Start address	Number of write bytes	
		ASCII	Hexadecimal
Data	Reading start address (0000 to 1FFF) *Hexadecimal	Specify the number of write bytes (0001 to 2000) *Hexadecimal	

Response Format (The number of characters for each item is given beneath it.)

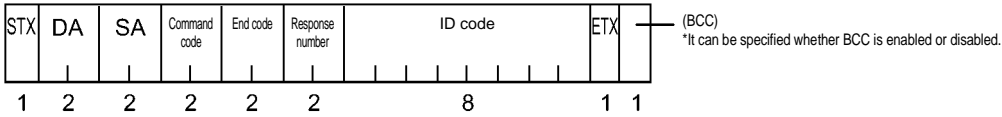

DA	Destination (host) station number. *In the command format, the destination is an Antenna.
SA	Source (Antenna) station number.
End code	00: Normal end. For other end codes, refer to 6-10 End Code List.
Response number	Always 01.
ID code	ID code of Tag. This is inherent to the Tag and cannot be rewritten.

Poling Response Format (The number of characters for each item is given beneath it.)

Response immediately after a polling command is sent.

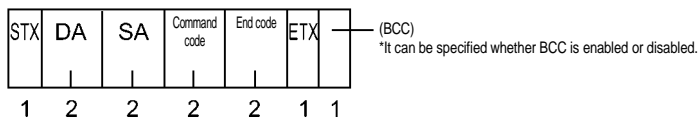

End code	Always 00.
----------	------------

Precaution for Correct Use

For the available number of write bytes, check the ID Tag memory capacity.

6-7-7 Designated Tag Data Fill

Writes the same data to a particular ID Tag.

Command Format (The number of characters for each item is given beneath it.)

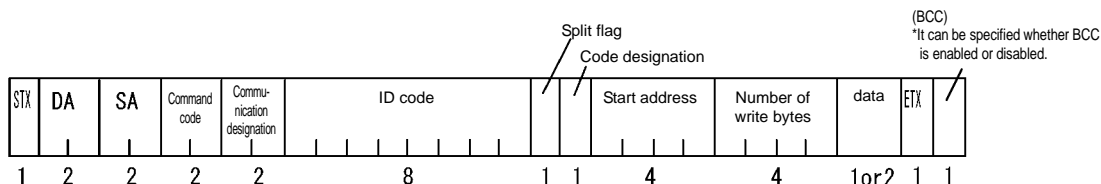

DA	Destination (Antenna) station number: 00 to 31. This can be modified in 6-9-8 Setting the Station Number.	Initial value: 00
SA	Source (host) station number: 80 to 89. If only one host is used, specify 80.	
Command code	F3: Single Trigger	
Communications designation	Gives communications designation to a Tag. SN: The Tag will enter sleep state after execution. WN: The Tag will enter standby state after execution.	
ID code	Specify an ID code of a particular Tag.	
Split flag	Specify "A".	
Code designation	Specify whether data read out of a Tag is ASCII or hexadecimal. A: ASCII H: Hexadecimal	
Start address	Specify according to the following table.	
Number of read bytes		
Data	If the code designation is ASCII, one character. If the code designation is hexadecimal, two characters.	

Start Address and Number of Read Bytes

Read content	Start address	Number of write bytes	
		ASCII	Hexadecimal
Data	Reading start address (0000 to 1FFF)	Specify the number of write bytes (0001 to 2000)	

Response Format (The number of characters for each item is given beneath it.)

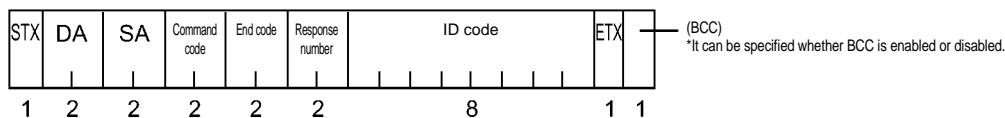

DA	Destination (host) station number. *In the command format, the destination is an Antenna.
SA	Source (Antenna) station number.
End code	00: Normal end. For other end codes, refer to 6-10 End Code List.
Response number	Always 01.
ID code	ID code of Tag. This is inherent to the Tag and cannot be rewritten.

Precaution for Correct Use

For the available number of write bytes, check the ID Tag memory capacity.

6-7-8 Communications Test

To check the radio wave environment, data (256 bytes) is communicated 256 times between the Antenna and Tag and the communications status is output. A total of 128 kbytes of data is communicated both ways. It takes a few seconds to execute this test. Although communications are retried in actual use communications are not retried in a communications test.

Command Format (The number of characters for each item is given beneath it.)

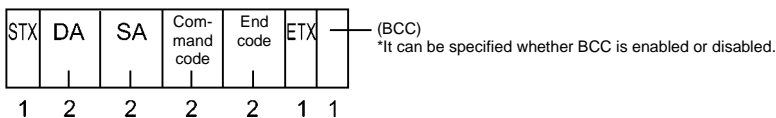

DA	Destination (Antenna) station number: 00 to 31. This can be modified in 6-9-8 Setting the Station Number.	Initial value: 00
SA	Source (host) station number: 80 to 89. If only one host is used, specify 80.	
Command code	T0: Single Trigger	
Communications designation	SU: The Tag will enter sleep state after execution.	

Response Format (The number of characters for each item is given beneath it.)

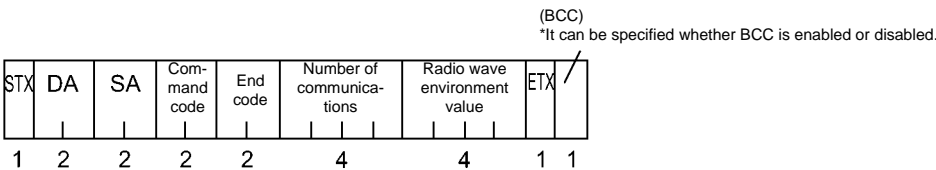

DA	Destination (host) station number. *In the command format, the destination is an Antenna.
SA	Source (Antenna) station number.
End code	Always 00.
Number of communications	Always 0256.
Radio wave environment value	0000 to 0256 (decimal) A smaller radio wave environment value shows a better radio wave environment. (The radio wave environment value is the number of failed communications out of a total of 256 communications. In the communications test, communications are not retried. When communications fail in actual operation, however, communications are retried. If the radio wave environment value is 50 or less, a communications error will not occur in actual operation.)

Precaution for Correct Use

Check your radio wave environment with this command before operating your system. We recommend you maintain a radio wave environment value of 50 or less.

6-8 Antenna Operation Commands

6-8-1 Auto Repeat Cancel

Cancels the Auto or Repeat command during execution of the command. After execution, the Antenna will wait for another command.

Command Format (The number of characters for each item is given beneath it.)

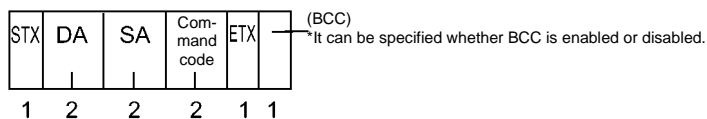

DA	Destination (Antenna) station number: 00 to 31. This can be modified in 6-9-8 Setting the Station Number.	Initial value: 00
SA	Source (host) station number: 80 to 89. If only one host is used, specify 80.	
Command code	C2	

Response Format (The number of characters for each item is given beneath it.)

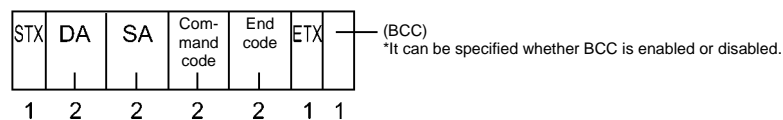

DA	Destination (host) station number. *In the command format, the destination is an Antenna.
SA	Source (Antenna) station number.
End code	Always 00.

6-8-2 Reset

Resets the Antenna. It takes approximately 2 seconds to reset.

Resetting:

- Clears data read out of a Tag at polling. After resetting, a response will not be returned for the Request to Response (H0) command.
- Clears the immediately preceding response. After resetting, a response will not be returned for the Request to Retransmit (H1) command.
- Changes the Radio Wave Transmission ON mode to the Radio Wave Transmission OFF mode.
- Enables the Host Communications Condition Setting (Section 6-9-7) and Station Number Setting (Section 6-9-8) commands.

Command Format (The number of characters for each item is given beneath it.)

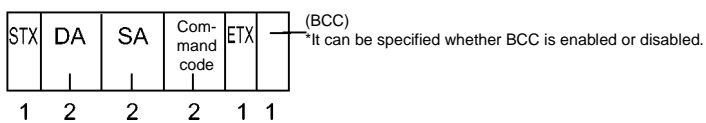

DA	Operation mode	Destination (Antenna) station number: 00 to 31. This can be modified in 6-9-8 Setting the Station Number.	Initial value: 00
	Setting mode	99	
SA	Source (host) station number: 80 to 89. If only one host is used, specify 80.		
Command code	C0		

Response Format

There is no response format.

6-8-3 Request to Respond

Requests a Tag to respond during the execution of a polling command.

Command Format (The number of characters for each item is given beneath it.)

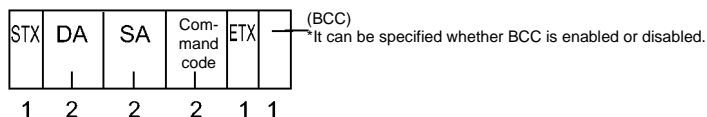

DA	Destination (Antenna) station number: 00 to 31. This can be modified in 6-9-8 Setting the Station Number.	Initial value: 00
SA	Source (host) station number: 80 to 89. If only one host is used, specify 80.	
Command code	H0	

Response Format (The number of characters for each item is given beneath it.)

- If a Tag responds:
The response received from Tag that received the Polling command is returned.

- If a Tag does not respond:

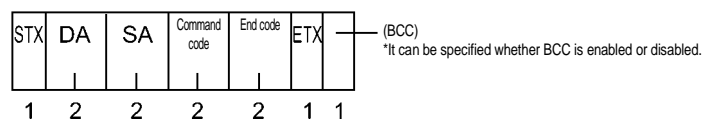

DA	Destination (host) station number. *In the command format, the destination is an Antenna.
SA	Source (Antenna) station number.
End code	Always 74.

6-8-4 Request to Retransmit

Request to retransmit the immediately preceding response.

Command Format (The number of characters for each item is given beneath it.)

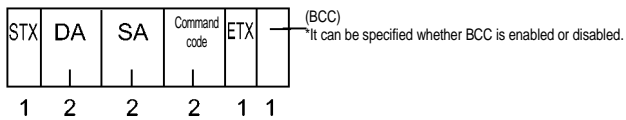

DA	Destination (Antenna) station number: 00 to 31. This can be modified in 6-9-8 Setting the Station Number.	Initial value: 00
SA	Source (host) station number: 80 to 89. If only one host is used, specify 80.	
Command code	H1	

Response Format (The number of characters for each item is given beneath it.)

- If there is an immediately preceding response, that response is returned.
- If there is no immediately preceding response (i.e., it is not stored in the Antenna), the following response is returned.

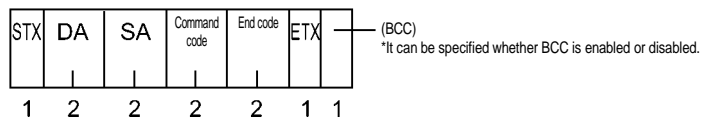

DA	Destination (host) station number. *In the command format, the destination is an Antenna.
SA	Source (Antenna) station number.
End code	Always 15.

6-9 Antenna Setting Commands

6-9-1 Radio Wave Transmission ON/OFF

Specifies the radio wave transmission OFF mode or radio wave transmission ON mode for the Antenna. (Refer to (2) in Section 6-2-3.) This command can be used in operation mode, not in setting mode. (Refer to Section 6-1 and (3) in Section 6-4.) When the power supply is reset or a reset command is executed, the radio wave transmission OFF mode (initial value) is enabled.

Command Format (The number of characters for each item is given beneath it.)

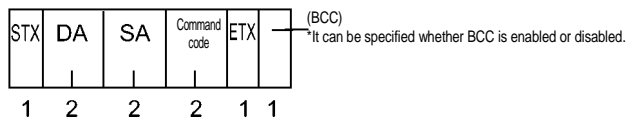

DA	Destination (Antenna) station number: 00 to 31. This can be modified in 6-9-8 Setting the Station Number.	Initial value: 00
SA	Source (host) station number: 80 to 89. If only one host is used, specify 80.	
Command code	A0: Specifies the radio wave transmission OFF mode. A1: Specifies the radio wave transmission ON mode.	Initial value: Radio wave transmission OFF mode

Response Format (The number of characters for each item is given beneath it.)

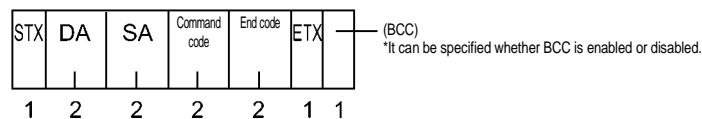

DA	Destination (host) station number. *In the command format, the destination is an Antenna.
SA	Source (Antenna) station number.
End code	Always 00.

6-9-2 Communications Range and Radio Wave Channel Selection

Selects the communications range (output power mode) and radio wave channel for the Antenna. The communications range can be changed by selecting the output power mode. The frequency is changed by selecting the radio wave channel and to help prevent interference between Antennas and interference caused by any other radio equipment.

Command Format (The number of characters for each item is given beneath it.)

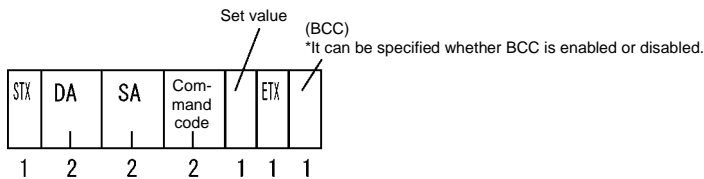

DA	Operation mode	Destination (Antenna) station number: 00 to 31. This can be modified in 6-9-8 Setting the Station Number.	Initial value: 00
	Setting mode	99	
SA	Source (host) station number: 80 to 89. If only one host is used, specify 80.		
Command code	A4: Selects the communications range (output power mode). A5: Selects the radio wave channel.		
Set value	For the command A4 L: 2 m (low-power mode) H: 5 m (high-power mode)		Initial value: 2 m (low-power mode)
	For the command A5 0 to 9: One of text divisions of frequency range 2,437.5 to 2,462.5 MHz		Initial value: Radio wave channel Channel 5

Response Format (The number of characters for each item is given beneath it.)

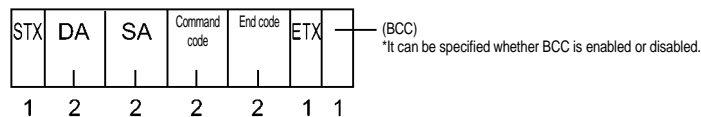

DA	Destination (host) station number. *In the command format, the destination is an Antenna.
SA	Source (Antenna) station number.
End code	Always 00.

Laws and Standards

- Always use the low-power (2 m) mode when using the Antenna in the USA.
- Always use radio wave channel 5 when using the Antenna in Iceland, Ireland, England, Italy, Austria, the Netherlands, Greece, Switzerland, Spain, Denmark, Norway, Finland, France, Belgium, or Luxemburg.

6-9-3 Radio Wave Output Status Read

Reads the communications range (power output mode) and radio wave channel of the Antenna.

Command Format (The number of characters for each item is given beneath it.)

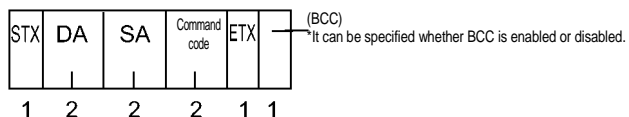

DA	Operation mode	Destination (Antenna) station number: 00 to 31. This can be modified in 6-9-8 Setting the Station Number.	Initial value: 00
	Setting mode	99	
SA	Source (host) station number: 80 to 89. If only one host is used, specify 80.		
Command code	A6		

Response Format (The number of characters for each item is given beneath it.)

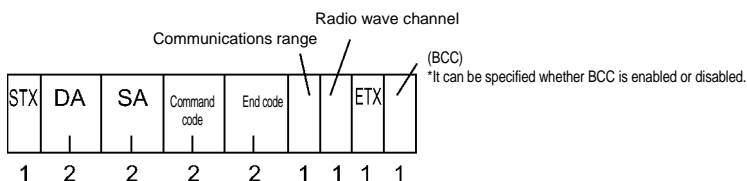

DA	Destination (host) station number. *In the command format, the destination is an Antenna.
SA	Source (Antenna) station number.
End code	Always 00.
Communications range	L: 2 m (low-power mode) H: 5 m (high-power mode)
Radio wave channel	One of text divisions of frequency range 2,437.5 to 2,462.5 MHz

6-9-4 Setting the Time to Wait for a Tag

Specifies the time to wait for communications with a Tag after sending an Auto or Repeat command. The initial value is infinity (0000).

When the waiting time for Tag has been elapsed for the Auto command, the Antenna will return a no-Tag error response of 72 and will discontinue the Auto command. When the waiting time for Tag has been elapsed for the Repeat command, the Antenna will return a no-Tag error response of 72 and will continue the Repeat command.

Command Format (The number of characters for each item is given beneath it.)

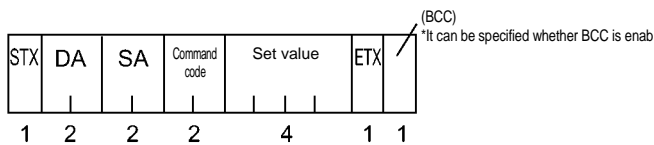

DA	Operation mode	Destination (Antenna) station number: 00 to 31. This can be modified in 6-9-8 Setting the Station Number.	Initial value: 00
	Setting mode	99	
SA	Source (host) station number: 80 to 89. If only one host is used, specify 80.		
Command code	T4		
Set value	0000: Infinity. 0001 to 9999: A left value x 100 ms.		Initial value: 0000 (infinity)

Response Format (The number of characters for each item is given beneath it.)

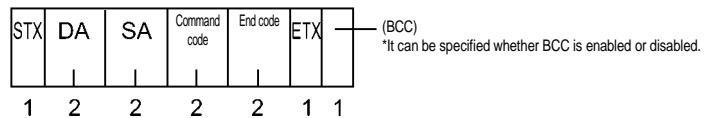

DA	Destination (host) station number. *In the command format, the destination is an Antenna.
SA	Source (Antenna) station number.
End code	Always 00.

6-9-5 Setting the Command Data Response Time

Specifies the minimum time until the Antenna returns a response after receiving a command and the minimum time until the Antenna returns the next response after returning the last response. The initial values are 10 ms. (Refer to "Precaution for Correct Use" of (2) in Section 5-2-2.)

Command Format (The number of characters for each item is given beneath it.)

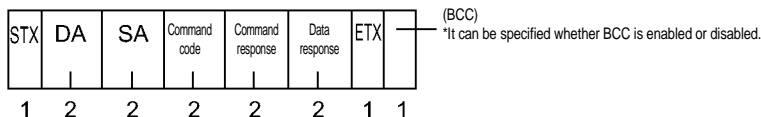

DA	Operation mode	Destination (Antenna) station number: 00 to 31. This can be modified in 6-9-8 Setting the Station Number.	Initial value: 00
	Setting mode	99	
SA	Source (host) station number: 80 to 89. If only one host is used, specify 80.		
Command code	H4		
Command response	Specifies the minimum time until the Antenna returns a response after receiving a command: 00 to 99 (ms): Number at left × 1 ms		Initial value: 10 (10 ms)
Data response	Specifies the minimum time until the Antenna returns the next response after returning the last response when the Antenna returns several responses: 00 to 99 (ms): Number at left × 1 ms		Initial value: 10 (10 ms)

Response Format (The number of characters for each item is given beneath it.)

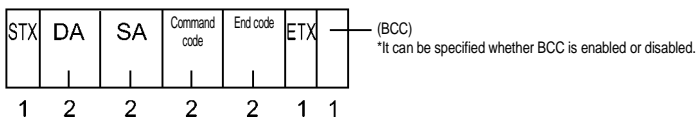

DA	Destination (host) station number. *In the command format, the destination is an Antenna.
SA	Source (Antenna) station number.
End code	Always 00.

6-9-6 Read Data Length Setting

Specifies the maximum number of read bytes that can be returned as one response for a Read command. If the conditions of communications with the host are good, specify a large number. If not, specify a small number.

Data will be returned in multiple responses if the maximum number of read bytes is exceeded for one command. For example, if you try to read 2,048 bytes of data using the Read command with a maximum read data length of 256 bytes, the Antenna will return eight responses.

Command Format (The number of characters for each item is given beneath it.)

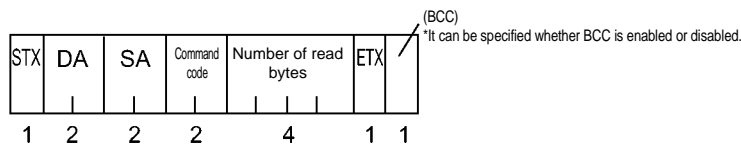

DA	Operation mode	Destination (Antenna) station number: 00 to 31. This can be modified in 6-9-8 Setting the Station Number.	Initial value: 00
	Setting mode	99	
SA	Source (host) station number: 80 to 89. If only one host is used, specify 80.		
Command code	H3		
Number of read bytes	0020 to 4000 (hexadecimal), Unit: byte		Initial value: 0100 (256 bytes)

Response Format (The number of characters for each item is given beneath it.)

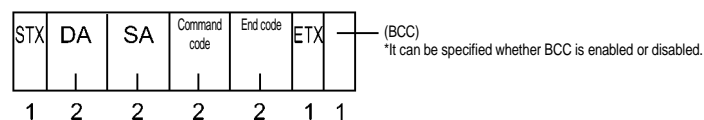

DA	Destination (host) station number. *In the command format, the destination is an Antenna.
SA	Source (Antenna) station number.
End code	Always 00.

6-9-7 Setting Host Communications Conditions

Specifies the conditions of communications between the host and Antenna. To enable communications settings, you must send this command and then send the Reset command (Section 6-8-2) or reset the power supply.

Command Format (The number of characters for each item is given beneath it.)

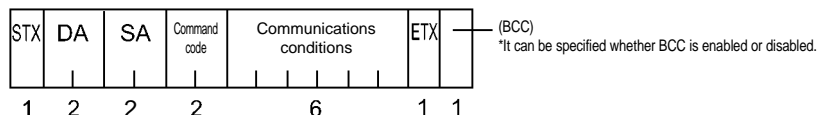

DA	Operation mode	Destination (Antenna) station number: 00 to 31. This can be modified in 6-9-8 Setting the Station Number.	Initial value: 00
	Setting mode	99	
SA	Source (host) station number: 80 to 89. If only one host is used, specify 80.		
Command code	H5		
Communications condition data	As described below.		

Set Character String (Specify all of the following parameters in order as listed below.)

Parameter name	Byte length	Set value	Meaning	Initial value Communications conditions in setting mode
Baud rate	1	1	4.8 kbps	2 = 9.6 kbps
		2	9.6 kbps	
		3	19.2 kbps	
		4	38.4 kbps	
		5	57.6 kbps	
		6	115.2 kbps	
Data length	1	7	7 bits	7 = 7 bits
		8	8 bits	
Parity	1	E	Even	E = Even
		O	Odd	
		N	None	
Stop bits	1	1	1 bit	2 = 2 bits
		2	2 bits	
Communications mode	1	0	Fixed	0
BCC enabled/disabled	1	0	BCC disabled	0 = No BCC
		1	BCC enabled	

Response Format (The number of characters for each item is given beneath it.)

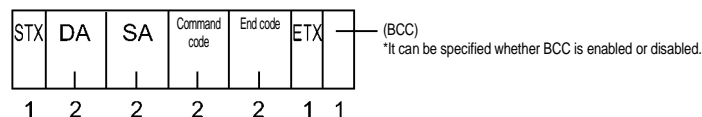

DA	Destination (host) station number. *In the command format, the destination is an Antenna.
SA	Source (Antenna) station number.
End code	Always 00.

Precaution for Correct Use

If the data length is set to 7 bits, only alphanumerical characters can be used.

6-9-8 Setting the Station Number

Specifies the station number of an Antenna as a wireless station. To enable this setting, you must send this command and then send the Reset command (Section 6-8-2) or reset the power supply.

Command Format (The number of characters for each item is given beneath it.)

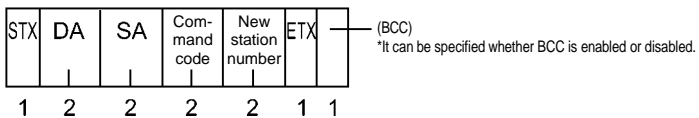

DA	Operation mode	Destination (Antenna) station number: 00 to 31.	Initial value: 00
	Setting mode	99	
SA	Source (host) station number: 80 to 89. If only one host is used, specify 80.		
Command code	H6		
New station number	00 to 31		

Response Format (The number of characters for each item is given beneath it.)

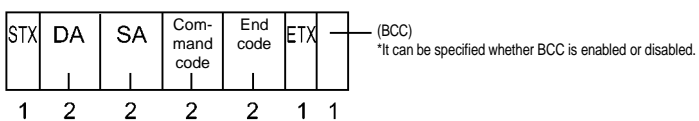

DA	Destination (host) station number. *In the command format, the destination is an Antenna.
SA	Source (Antenna) station number.
End code	Always 00.

6-9-9 Reading Settings

Reads Antenna attributes, settings, date of production, etc.

Command Format (The number of characters for each item is given beneath it.)

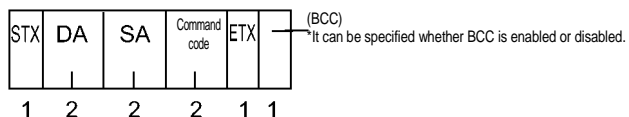

DA	Operation mode	Destination (Antenna) station number: 00 to 31. This can be modified in 6-9-8 Setting the Station Number.	Initial value: 00
	Setting mode	99	
SA	Source (host) station number: 80 to 89. If only one host is used, specify 80.		
Command code	M2		

Response Format (The number of characters for each item is given beneath it.)

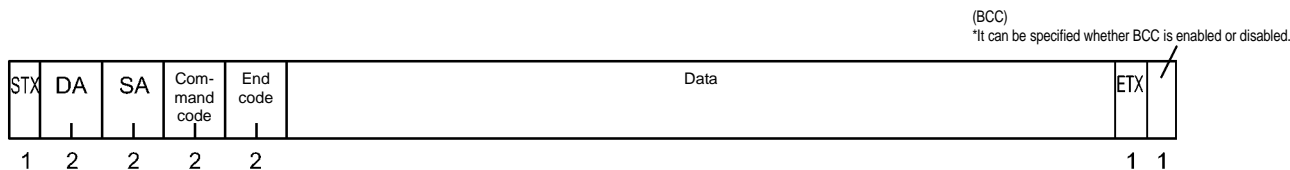

DA	Destination (host) station number. *In the command format, the destination is an Antenna.
SA	Source (Antenna) station number.
End code	Always 00.
Data	As described below.

Data Read for Settings (M2)

Data Name	Radio wave transmission OFF time	Power output mode	Radio wave channel	Waiting time for Tag	Command response time	Data response time	Read data length	Communications condition	Station number	Number of retries	
Data	"0000"	"H/L"	*	"eeee"	"nn"	"ii"	"kkkk"	"abcdef"	"ff"	"m"	
Number of characters	4	1	1	4	2	2	4	6	2	1	Total 27

Note: The radio wave transmission OFF time and the number of retries are fixed.

6-10 End Code List

The meanings of end codes in responses are given below.

Type	End code	Name	Description
Normal end	00	Normal end	Command execution has ended normally.
	15	Non-executable	There is no immediately preceding response for a Request to Retransmit command (Section 6-8-4).
	72	Multi Trigger ended	Multi Trigger ended.
	74	No polling Tag communications	Communications with a Tag for a Polling command are not finished.
Host communications error	10	Parity error	A parity error occurred in a character of command.
	11	Framing error	A framing error occurred in a character of command.
	12	Overrun error	An overrun error occurred in a character of command.
	13	BCC error	BCC in received command is invalid.
	14	Format error	A format of a command received without error is incorrect.
	15	Non-executable	A received command cannot be executed in the current mode.
Communications error	18	Frame length error	ETX has not been received after receiving more than 8,220 characters after STX.
	70	Communications error	An error has occurred during communications with a Tag and the communications cannot be completed normally.
	71	Verification error	Writing was not performed correctly. A data error was detected during write verification.
	72	No-Tag error	There was no Tag in front of the Antenna when the Trigger command was executed. Waiting time for a Tag has expired for the Auto Repeat command.
	7A	Address error	Memory address of nonexistent ID Tag was designated.
	7B	Battery voltage low	Voltage of battery built in an ID Tag is low. The complete response will be returned for this end code only.
System error	7D	Write Protect error	An attempt was made to write to a write-protected page.
	92	Antenna failure	Failure of radio wave transmitter, etc. or an error in the program in the Antenna.
	93	Tag memory error	An ID Tag data error was detected while reading data.

Precaution for Correct Use

If a communications error or verification error occurs during execution of a Write command, the data at the address designated in the command may be rewritten partially or completely.

Chapter 7 Startup and Operating Procedures

7-1 Trial Operation

◆ Items to Check

Before performing trial operation, check the following items:

No.	Items to check	Checking	Reference
1	Installation environment of Antenna and Tag	Whether the installation environment is suitable.	Section 5-1-1
2	Installation of Antenna and Tag	Whether the Antenna and Tag are installed correctly.	Section 5-1-2 and 5-1-3
3	Connection of Antenna and Connecting Cable	Whether the connector is connected properly.	Section 5-1-4
4	Connection to host	<ul style="list-style-type: none"> • Whether RS-232C, RS-422A, and RS-485 are connected properly. • Whether connected to 24 VDC power supply. • Whether installed. • Whether +P and -P are connected. 	Section 5-2
5	Installation of Link Unit for RS-422A and RS-485	Whether the Link Unit is installed correctly.	Section 5-3

◆ Trial Operation Procedure

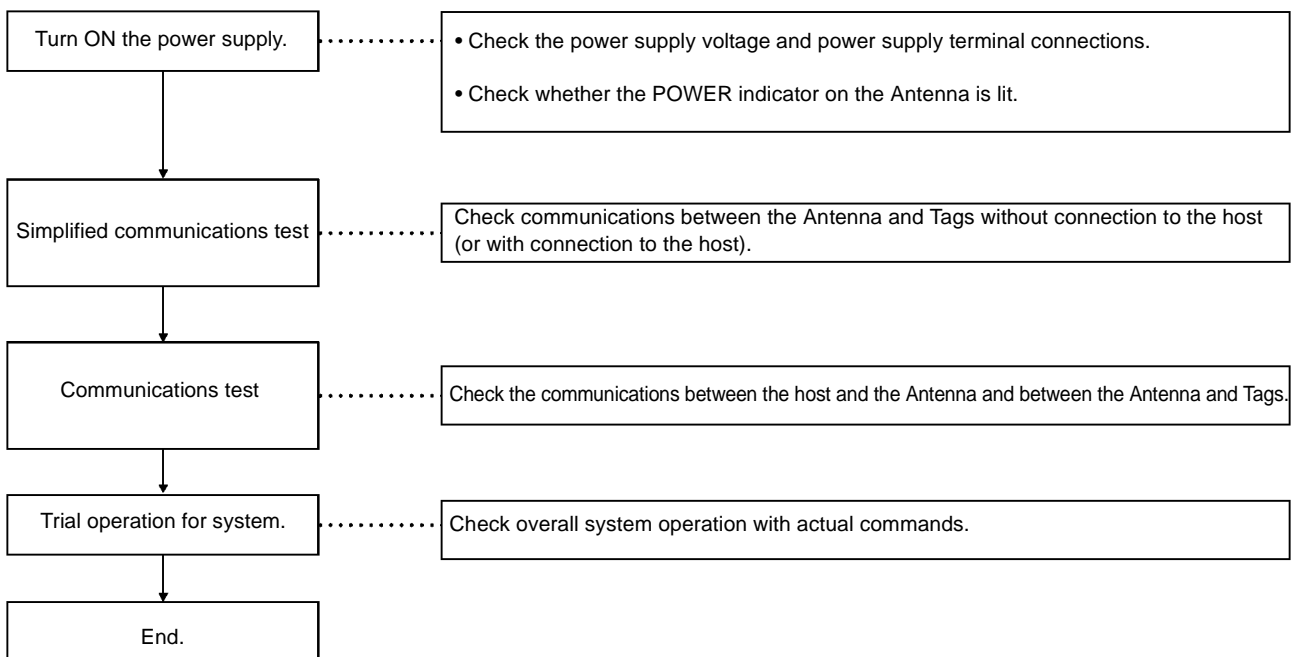

◆ Simplified Communications Test

Communications between the Antenna and Tags can be tested without connection to the host. Use this test to check the location of the Antenna and Tags. Refer to Section 4-4.

◆ Communications Test

The connection to the host is made and the Communications Test command is sent from the host to the Antenna. This enables checking the communications cable connections, communications processing, and communications status between the Antenna and Tags. Refer to Section 4-5.

7-2 Diagnosis Function

You can diagnose through the indicators on the Antenna to shorten the system down time if an error occurs in the Antenna.

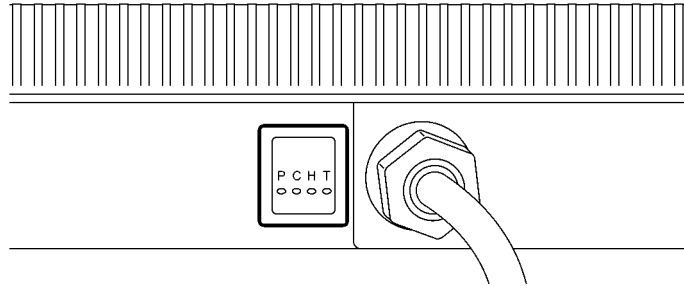

◆ During Normal Operation

Antenna Indicator				Meaning
P (green)	C (red)	H (yellow)	T (green)	
Power supply	Radio wave transmission	Host transmission	Tag transmission	
Lit	Not lit	Not lit	Not lit	Power is being supplied to the Antenna, but no communications with a Tag are in progress.
Lit	Sometimes lit	Not lit	Sometimes lit	Simplified communications function in setting mode is in progress.
Lit	Lit	Not lit	Sometimes lit	When indicator C is sometimes lit, the Antenna is waiting for a Tag. When indicator C is lit continuously, the Antenna is communicating with a Tag.
Lit	Sometimes lit	Sometimes lit	Sometimes lit	A Trigger command has been executed and communications with a Tag are in progress.
Lit	Lit	Not lit	Lit	An Auto or Repeat has been executed and the Antenna is waiting for a Tag.
Lit	Lit	Sometimes lit	Lit	An Auto or Repeat has been executed and communications with a Tag are in progress.

:Sometimes lit: Lit only during radio wave transmission or communications.

◆ Following an Error

Trouble	Antenna Indicator				Probable cause	Countermeasures
	P (green)	C (red)	H (yellow)	T (green)		
	Power supply	Radio wave transmission	Host communications	Tag transmission		
Antenna does not respond	Not lit	Not lit	Not lit	Not lit	<ul style="list-style-type: none"> An error in the power supply to the Antenna Antenna failure. 	<ul style="list-style-type: none"> Check the power supply voltage. Replace the Antenna with a new one.
	Flashing	Flashing	Not lit	Not lit	<ul style="list-style-type: none"> Antenna failure. 	<ul style="list-style-type: none"> Replace the Antenna with a new one.
	Lit	Not lit	Not lit	Not lit	<ul style="list-style-type: none"> An error in communications with the host. 	<ul style="list-style-type: none"> Check the communications line to the host.
	Lit	—	Flashing	—		
Tag does not respond	Lit	Lit during communications	—	Flasing	<ul style="list-style-type: none"> The Tag is in sleep state. Tag failure. Antenna failure. 	<ul style="list-style-type: none"> Take the Tag out of the communications area and return it to the area again. Replace the Tag with a new one. Replace the Antenna with a new one.

7-3 Error List

Refer to 6-10 End Code List also.

◆ Host Communications Error

Error code	Name	Check points
10	Parity error	<ul style="list-style-type: none"> • Settings of the communication conditions with the host → Refer to Section 6-9-7 and 6-9-9. • Wiring of RS-232C, RS-422A, and RS-485 (Example: Terminating resistance and influence of ambient noise) → Refer to Sections 5-2, 5-3 and 7-4.
11	Framing error	
12	Overrun error	
13	BCC error	<ul style="list-style-type: none"> • Calculating the BCC → Refer to Section 6-3. • Wiring of RS-232C, RS-422A, and RS-485 (Example: Terminating resistance and influence of ambient noise) → Refer to Sections 5-2, 5-3 and 7-4.
14	Format error	<ul style="list-style-type: none"> • Command format (Example: Applicable characters and position of STX/ETX) → Refer to Sections 6-7 to 6-9.
18	Frame length error	

◆ Communications Errors

Error code	Name	Check points
70	Communications error	<ul style="list-style-type: none"> • Distance between the Antenna and Tags, and Tag movement speed • Wiring of FG, power cable, etc. (Influence of ambient noise) • Noise environment around Antenna (FG ground of devices, shield and location change) → Refer to Sections 5-2, 5-3 and 7-4.
71	Verification error	<ul style="list-style-type: none"> • Noise environment around Antenna. (FG ground of devices, shield, and location) → Refer to Sections 5-2, 5-3 and 7-4.
72	No existence error	<ul style="list-style-type: none"> • Distance between the Antenna and Tags, and Tag movement speed
7A	Address error	<ul style="list-style-type: none"> • Designation of address/number of bytes in executed command • Tag memory capacity and applicable address range → Refer to Section 6-7.
7B	Battery voltage low	<ul style="list-style-type: none"> • Traffic, ambient temperature, and battery life → Refer to Section 3-2-4 and 3-2-5.
7D	Write protection error	<ul style="list-style-type: none"> • Write protection settings → Refer to Section 4-6. • Designation of address/number of bytes in executed command → Refer to Section 6-7.

◆ System Errors

Error code	Name	Check points
92	Antenna failure	<ul style="list-style-type: none"> • Antenna indicators → Section 7-2.
93	Tag memory error	<ul style="list-style-type: none"> • Take the Tag out of the communications area, return it to the area again, and check the end code. If the same error occurs, replace the Tag with a new one.

7-4 Errors and Countermeasures

The eight main causes of troubles in V690 Series are as follows:

- Influence of installation environment Refer to Section 5-1-1.
 - Influence of noise. Take countermeasures against noise.
 - External device failure
 - Antenna failure
 - Link Unit failure
 - Cable failure
 - Tag failure
 - Others
- } Must be repaired.

◆ Influence of Noise

If an error occurs in operation of your system, take suitable countermeasures against noise, referring to the following table.

No.	Trouble	Estimated Cause	Countermeasures
1	Troubles caused by large-capacity motors, transformers, capacitors, etc., when power is turned ON	Instantaneous voltage drop in power supply system due to inrush current of large-capacity load	<ul style="list-style-type: none"> • Increase the capacity of power supply equipment or of power cable.
		Common mode noise due to above cause	<ul style="list-style-type: none"> • Supply the power through 1:1 non-contact insulation transformer. • Do not use together with a ground to any large-capacity load. Ground to 100 Ω or less
2	Trouble caused at irregular intervals	Noise superposed on the power supply	<ul style="list-style-type: none"> • Supply the power through 1:1 non-contact insulation transformer or noise filter. • Do not use together with a ground to any large-capacity load. Ground to 100 Ω or less.
		Influence of space noise	<ul style="list-style-type: none"> • Keep the Antenna at least 1 meter or more away from any computer, AC adapter for a computer, switching power supply, programmable terminal, motor, proximity switch, etc.

• Improving the Ground

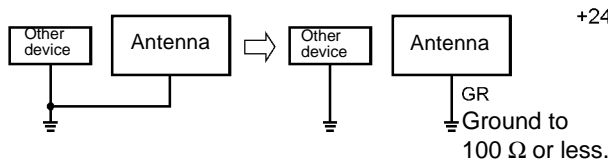

• Countermeasure against Power Supply Noise

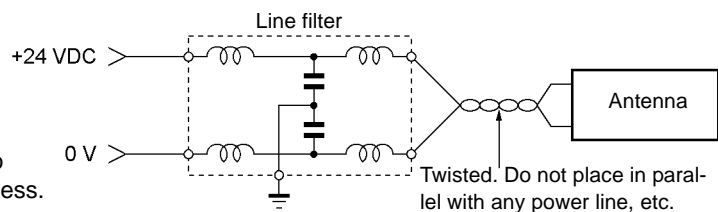

Precaution for Correct Use

A distance of 1 meter away from a noise generating source is a reference value. Depending on the noise generating source, more than 1 meter will be required. Perform a communications test to check.

7-5 Maintenance and Inspection

To maintain the V690 Series in the best condition, you need to inspect it daily or periodically. The V690 Series mainly consists of semiconductor components which have a long life. However, the following malfunctions are expected with time depending on the service environment and operating conditions.

- (1) Deterioration of elements due to overvoltages or overcurrents.
- (2) Deterioration of elements due to long-term stress from use in a high-temperature site.
- (3) Deterioration of insulation or imperfect contact of connectors due to unsuitable temperature or dust.
- (4) Imperfect contact of connectors or corrosion of elements due to corrosive gas.

◆ Inspection Items

No.	Inspection Item	Inspection	Criterion	Remarks
1	Fluctuation of power supply voltage	(1) Check at a terminal block of power supply.	Within the specifications for power supply voltage.	Tester.
		(2) Check whether instantaneous power failure occurs frequently and whether voltage fluctuates are too large.	Within a allowable voltage fluctuation range.	Power supply analyzer.
2	Ambient environment (1) Temperature (2) Humidity (3) Vibration or shock (4) Dust (5) Corrosive gas	(1) Within specifications. (2) Within specifications. (3) Influence of vibration or shock from machines. (4) Dust or foreign material. (5) Discoloration or corrosion in metal parts.	(1) Within specifications. (2) Within specifications. (3) Within specifications. (4) No dust or foreign material is acceptable. (5) No discoloration or corrosion is acceptable.	Lowest temperature thermometer. Hygrometer.
3	Panel conditions (1) Whether the panel is ventilated. (2) Whether packing material of sealed structure is deteriorated.	(1) Check whether natural ventilation or forced ventilation and cooling are adequate. (2) Check whether packing material in the panel is removed or damaged.	(1) Ventilation must be performed properly. Temperature must be within -10 and 55°C. (2) Any damage is unacceptable.	—
4	Power supply for I/O (1) Voltage fluctuation (2) Ripple	Check at a terminal block of every I/O section.	Within the specifications.	Tester. Oscilloscope.
5	Mounting state	(1) Whether every device is mounted tightly.	Every device must be mounted tightly.	—
		(2) Whether every connector is inserted completely.	Every connector must be locked properly and fixed by screws.	—
		(3) Whether terminal block screws are tightened completely.	The terminal block screws must be tightened completely.	—
		(4) Whether wire is damaged.	The wire must not be damaged.	—
		(5) Whether conditions between the Tags and Antenna are within the specifications.	The conditions must be within the specifications.	—
		(6) Whether the ground is properly connected to 100 Ω or less.		—

7-6 Troubleshooting

When an error has occurred, grasp the situation fully and check according to the flow below (“Trial operation procedure” in Section 7-1).

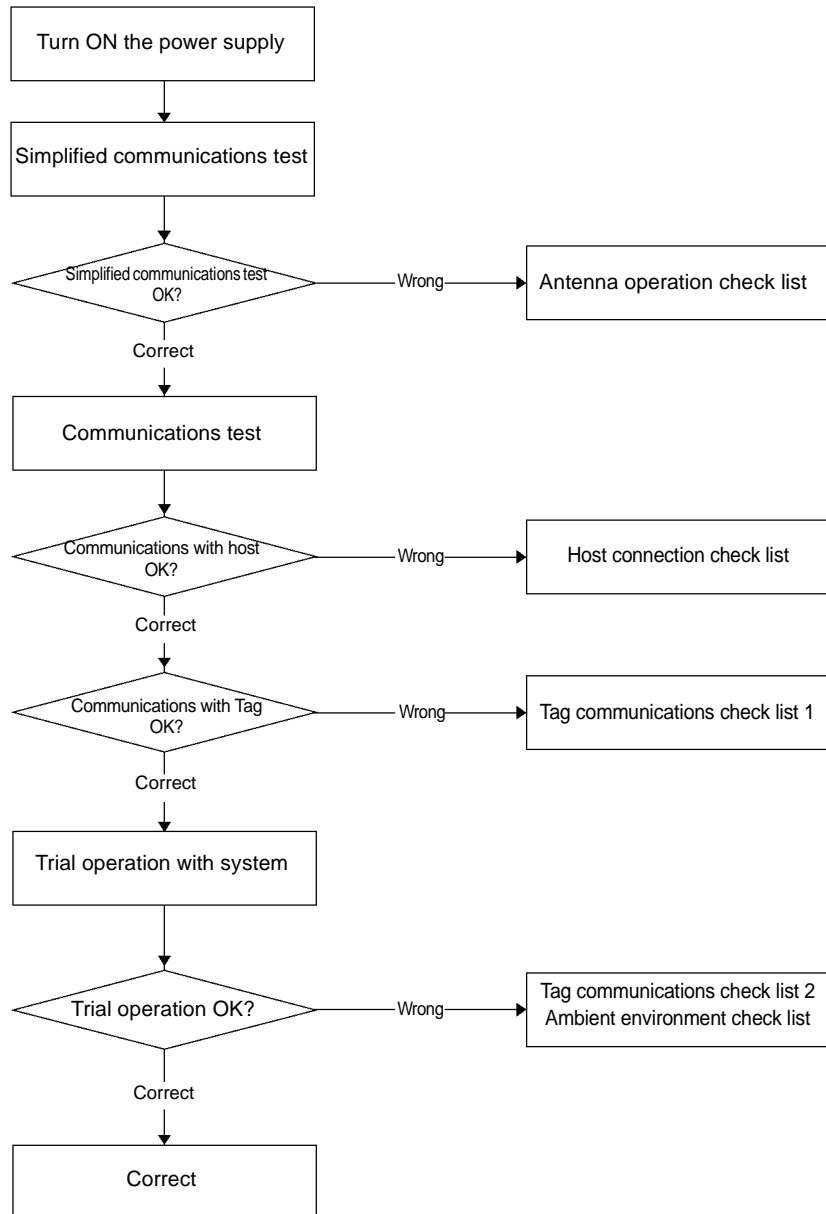

◆ Antenna Operation Check List

Check Point	Countermeasures
<input type="checkbox"/> Antenna's P indicator (power supply) lit.	<ul style="list-style-type: none"> • Check 24 VDC power supply line. • Turn ON the Antenna power supply switch on Link Unit. • Check the power supply voltage. • Replace the Antenna with a new one.
<input type="checkbox"/> Antenna's C indicator (radio wave transmission) lit.	<ul style="list-style-type: none"> • Enable the setting mode. → Refer to Section 4-4. • Replace the Antenna with a new one.

◆ Host Connection Check List

Check Point	Countermeasures
<input type="checkbox"/> Connection of the host communications cable, connectors, and Link Unit.	<ul style="list-style-type: none"> • Connect appropriately.
<input type="checkbox"/> Host communications conditions of Antenna.	<ul style="list-style-type: none"> • Modify the communications conditions. → Refer to Section 6-9-7 and 6-9-9.
<input type="checkbox"/> Host operation (communications port).	<ul style="list-style-type: none"> • Replace the host with a new one.
<input type="checkbox"/> Host communications conditions of host.	<ul style="list-style-type: none"> • Modify the communications conditions.
<input type="checkbox"/> Program at host.	<ul style="list-style-type: none"> • Modify the program.
<input type="checkbox"/> Antenna station number.	<ul style="list-style-type: none"> • Change the Antenna station number.
<input type="checkbox"/> Does H (host communications) indicator light momentarily when Antenna sends data to the host?	<ul style="list-style-type: none"> • Replace the Antenna with a new one.

◆ Tag Communications Check List 1

Check Point	Countermeasures
<input type="checkbox"/> Operation of Tag and Antenna. (Check communications distance.)	<ul style="list-style-type: none"> • Replace the Tag with a new one. • Replace the Antenna with a new one.

◆ Tag Communications Check List 2

Check Point	Countermeasures
<input type="checkbox"/> Check using 7-3 Error List	
<input type="checkbox"/> Distance between the Antenna and Tags.	<ul style="list-style-type: none"> • Change the output power mode (communications range): Low-power (2 m) or high-power (5 m).
<input type="checkbox"/> Tag face (front/reverse).	<ul style="list-style-type: none"> • Turn the Tag to face the Antenna.
<input type="checkbox"/> Tag movement speed.	<ul style="list-style-type: none"> • Movement speed. Change the movement speed.

◆ Ambient Environment Check List

Check Point	Countermeasures
<input type="checkbox"/> Radio wave interrupted by an object (e.g., human body) that contains metal or water.	<ul style="list-style-type: none"> • Remove the object. • Change the Antenna position.
<input type="checkbox"/> Dead zone generated by reflection at surrounding metal face.	<ul style="list-style-type: none"> • Change the metal object position. • Change the Antenna position. • Change the output power mode (communications range): Low-power (2 m) or high-power (5 m).
<input type="checkbox"/> Interference caused by an adjacent Antenna.	<ul style="list-style-type: none"> • Change the radio wave channel. • Move the installation location.
<input type="checkbox"/> Interference caused by wireless equipment.	<ul style="list-style-type: none"> • Change the radio wave channel. • Move the installation location.
<input type="checkbox"/> Check using 7-4 Errors and Countermeasures	
<input type="checkbox"/> Check using 7-5 Maintenance and Inspection	

Chapter 8 Communications Performance and Characteristic Data (Reference)

8-1 Communications Area (Reference)

- Ambient temperature: $20 \pm 5^\circ\text{C}$. Antenna and Tag rotation are shown below.
- Communications area at a height of 1.5 m in a large room where radio wave noise is minimal.

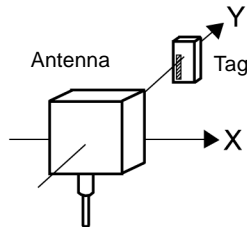

*The hatched area  on the Tag indicates the “omron” logo.

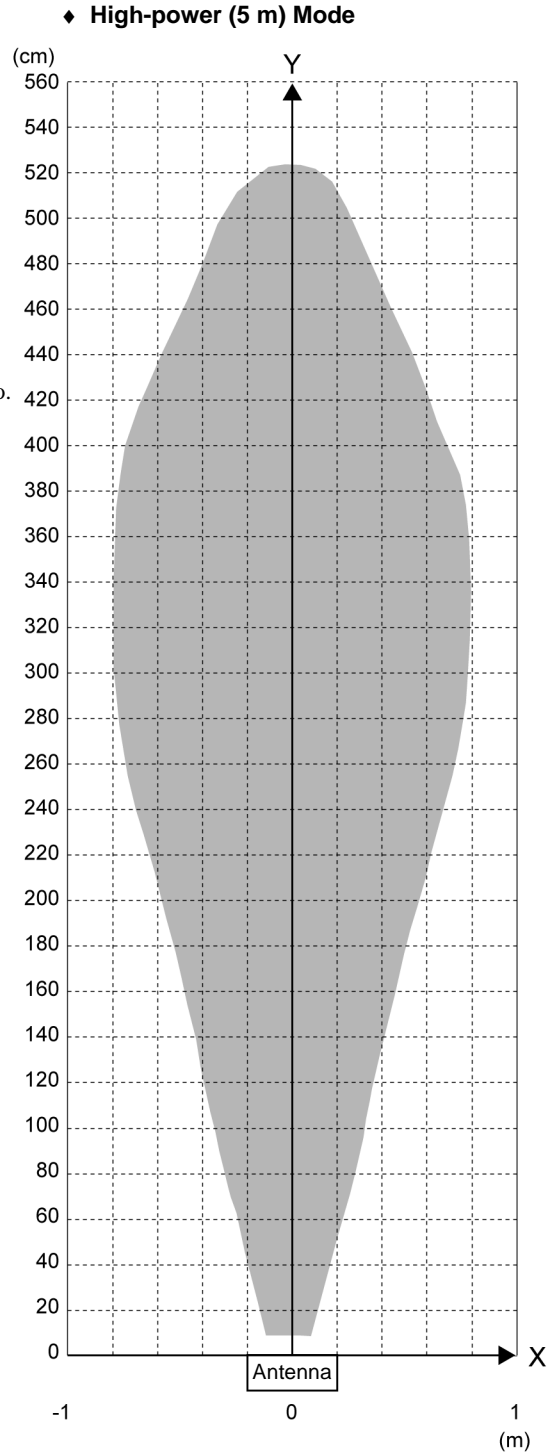
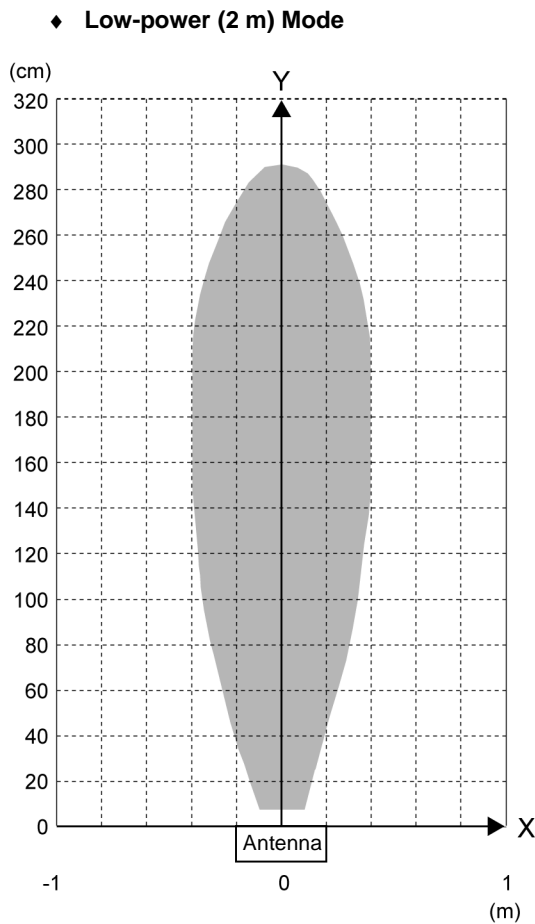

Precaution for Correct Use

Before operating the system, perform the communications test (Section 4-5) between the Antenna and Tags and check that the communications can be made reliably with the Tags.

8-2 Influence of Ambient Temperature (Reference)

The influence of ambient temperature for Tags is shown below.

Tag rotation: 0 to 360 degrees

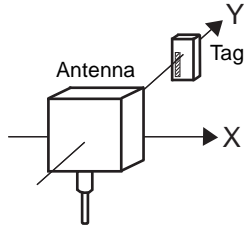

*The hatched area  on the Tag indicates the “omron” logo.

Low-power (2 m) Mode

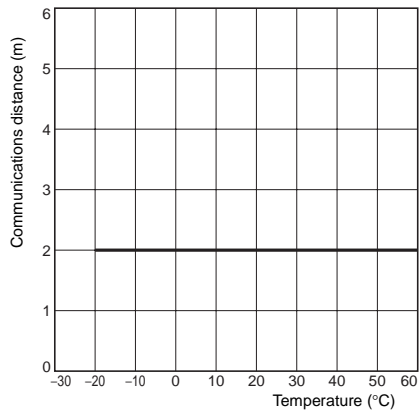

High-power (5 m) Mode

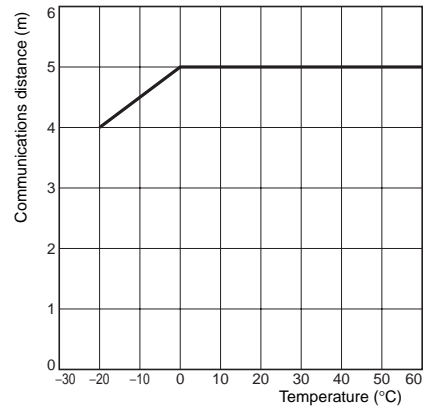

8-3 Communications Time (Reference)

The time required from starting to send a command until a response is received is called the TAT (Turn Around Time). The TAT is calculated by adding the communications time between the host and the Read/Write Antenna to the communications time between the Antenna and ID Tag. The communications time for the Tag depends on the number of bytes being processed and the amount of data, and is calculated as described below.

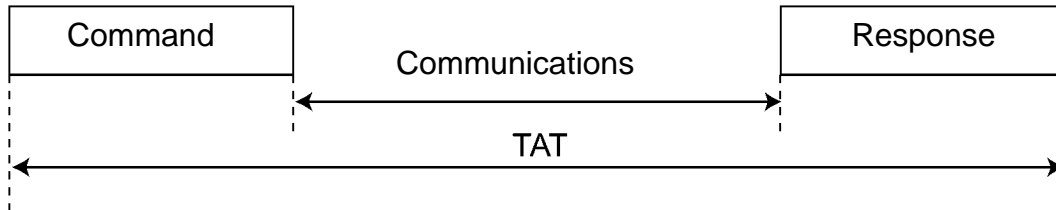

(1) One Tag

The communications designation is SU. N is the number of bytes. The command is Trigger, Auto, or Repeat.

Command	Communications time (ms)
Read	
Write (without verification read)	$t = 11 + 0.03 * N$
Write (with verification read)	$t = 13 + 0.06 * N$
ID code read	$t = 10$
Communications test	$t = 1,100$

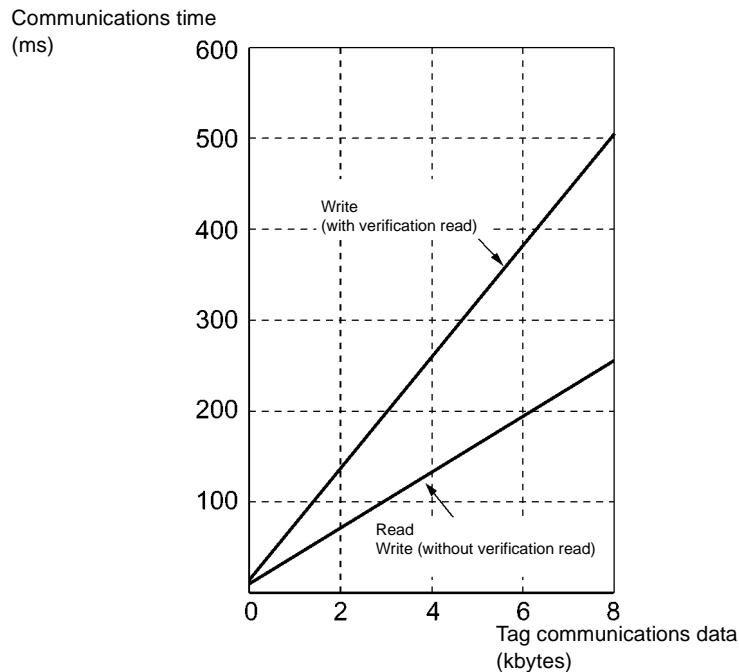

Precaution for Correct Use

The baud rate (115.2 kbps max.) between the host and Antenna is faster than that between the Antenna and a Tag. If the Tags move quickly to the front of the Antenna one after another, use the Polling command.

(2) Multi (Several Tags)

The communications time of Multi commands depends on the number of processed bytes, the number of Tags, and communications designation S/M/L. Average values are shown below.

Communications designation	Number of Tags	Average communications time (ms)
U	1	17
S	Approximately 4	65
M	Approximately 8	128
L	Approximately 16	256

(3) Calculating the Maximum Movement Speed of Tags

The maximum speed of a Tag moving at the front of the Antenna can be calculated as follows:

$$\text{Maximum movement speed} = \frac{\text{Travel distance in communications area}}{\text{Communications time}}$$

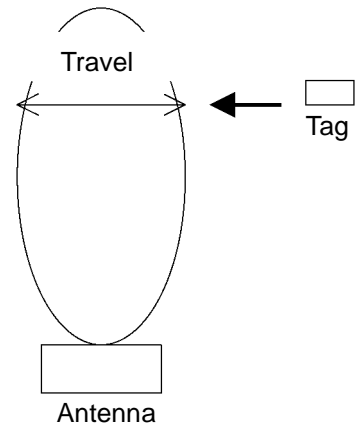

Example Calculation 1

Calculate the maximum speed of a Tag as shown below based on a distance of 1 m between the Antenna and Tag and a 32-byte read. If the distance is 2 m in low-power (2 m) mode, the area width is 0.8 m. The communications time for a 32-byte read is 12 ms.

$$\text{Maximum movement speed} = \frac{0.8 \text{ m}}{12 \text{ ms}} = \frac{0.8 \text{ m}}{0.012 \times 1/60 \text{ (minutes)}} = 4 \text{ km per minute (= 240 km per hour)}$$

Example Calculation 2

Calculate the maximum speed of a Tag as shown below based on a distance of 4 m between the Antenna and Tag and a 256-byte read. If the distance is 4 m in high-power (5 m) mode, the area width is 1.5 m. The communications time for a 256-byte read is 19 ms.

$$\text{Maximum movement speed} = \frac{1.5 \text{ m}}{19 \text{ ms}} = \frac{1.5 \text{ m}}{0.019 \times 1/60 \text{ (minutes)}} = 4.7 \text{ km per minute (= 280 km per hour)}$$

Precaution for Correct Use

The Tag movement time calculated above is under ideal conditions. In an actual operation, take into consideration peripheral objects and the radio wave environment at the working site, and design a system that includes a margin beyond the calculated value. Always execute tests at the working site.

8-4 Mutual Interference between Antennas (Reference)

- If several Antennas are used, communications may fail due to mutual interference. Maintain the specified installation distance shown below. The radio wave channel for both Antennas is set to 5 (2,450 MHz).
- If the installation distance shown below cannot be maintained, the distance may be reduced by using different radio wave channels. Refer to Section 4-3.

• Installing Antennas in Parallel with Each Other

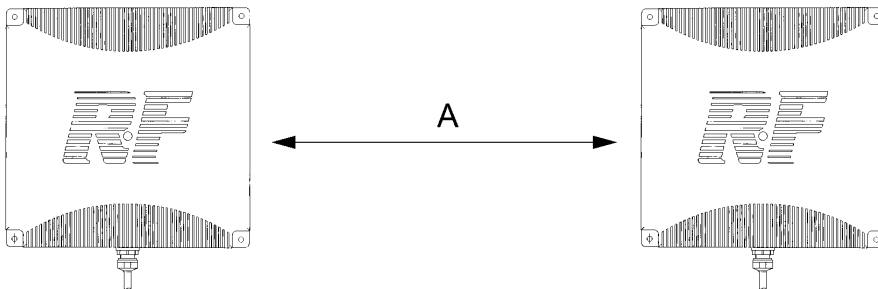

Communications range	Distance A
Low-power (2 m) mode	4.5 m min.
High-power (5 m) mode	6 m min.

• Installing Antennas Facing Each Other

Antennas cannot be installed facing each other

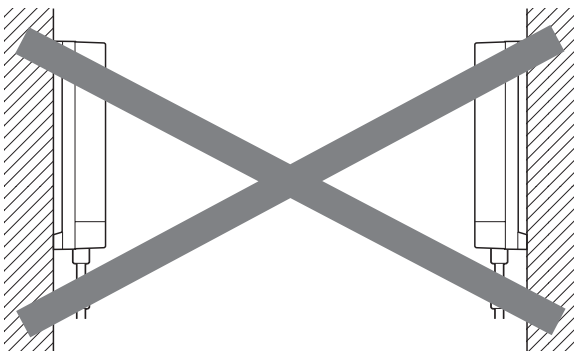

• Installing Antennas Facing Back to Back

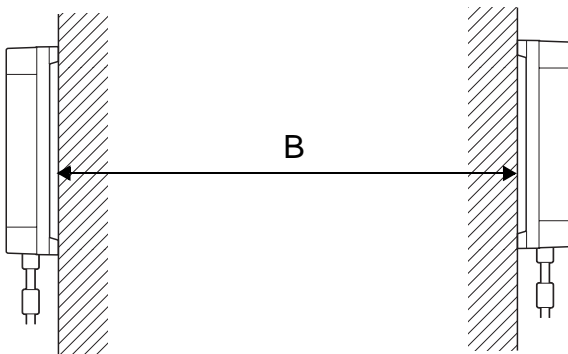

Communications range	Distance B
Low-power (2 m) mode	0.5 m min.
High-power (5 m) mode	0.5 m min.

8-5 Distance to Wireless LAN Cellular Phone (Reference)

- Radio wave interference caused by wireless LANs and cellular phones can cause RFID System communications to fail and the ID Tag battery power to be consumed. (Refer to *Interference with Second-generation Low-power Data Communications Systems (Wireless LANs), Cellular Phones, etc.* at the beginning of this manual.)
- Be sure to keep the specified distance from wireless LANs and cellular phones, as shown below.
- If any troubles occur, increase the distance.

	Prevention of RFID Communications Failure	Prevention of ID Tag Battery Power Loss
Wireless LANs OMRON's WD30M (See note.)	3 m min.	6 m min.
Cellular phones (800M, 1,500 MHz)	1 m min.	1 m min.
Personal handyphone systems (1,900 MHz)	1 m min.	50 cm min.
Bluetooth	4 m min.	1 m min.

Note: Set the channel of the Wireless LAN to 1 (2,400 MHz).

8-6 Influence of Tag Installation Angle (Reference)

- The maximum communications range can be achieved when the Antenna face and Tag face are in parallel with each other. If the Antenna and/or Tag are inclined, the communications range will be reduced. Install the Tags paying attention to the Tag angle.
- For Tag rotations of 0 degrees and 90 degrees, deterioration characteristics of the communications range depending on the Tag angle are shown below.
- The position of the antenna inside Tags makes the deterioration in the communications range depends on the installation angle (whether positive or negative).

• Horizontal Installation of Tags

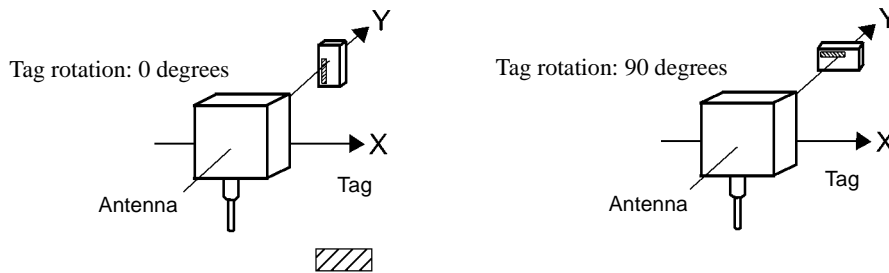

*The hatched area  on the Tag indicates the “omron” logo.

(1) Tag Rotation: 0 degrees

θ_H (°)	Deterioration in communications range	
	Low-power (2 m) mode	High-power (5 m) mode
+60	-35%	-45%
+45	-30%	-35%
+30	-20%	-30%
+15	-5%	-15%
0	0%	0%
-15	-5%	-15%
-30	-20%	-20%
-45	-30%	-45%
-60	-40%	-50%

(2) Tag Rotation: 90 degrees

θ_H (°)	Deterioration of communications range	
	Low-power (2 m) mode	High-power (5 m) mode
+60	-60%	-60%
+45	-45%	-45%
+30	-40%	-35%
+15	-5%	-15%
0	0%	0%
-15	-15%	-25%
-30	-30%	-35%
-45	-40%	-45%
-60	-40%	-45%

8-7 Influence of Back Metal (Reference)

Deterioration characteristics in the communications range depends on the distance between the Antenna and Tag and the back metal as shown below.

- **Antenna**

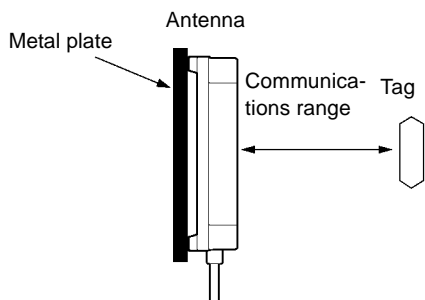

Influence of metal plate at the back of Antenna on the communications range is 1% or less.

*Metal plate: 350 x 350 x 1 (thickness) mm, aluminum or stainless steel

- **Tag**

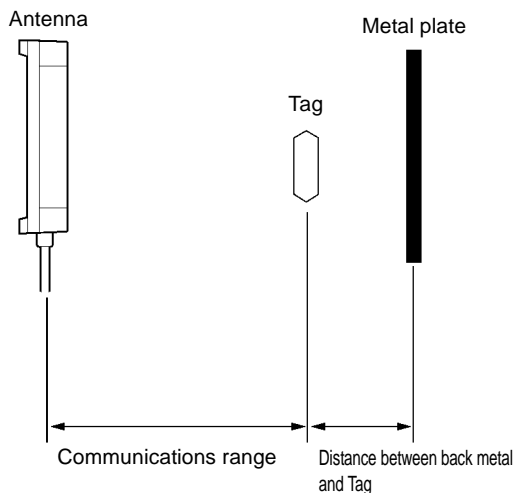

Distance between back metal and Tag	Communications	
	Low-power (2 m) mode	High-power (5 m) mode
0 mm	-10%	-25%
5 mm	-5%	-15%
10 mm or more	0%	-10%

*Metal plate: 120 x 120 x 1 (thickness) mm, aluminum or stainless steel

Appendix

Appendix 1 Glossary

Antenna

In this manual, refers to the Read/Write Antenna, a reader/writer which accesses an ID Tag in the RFID System.

ARIB

Association of Radio Industries and Businesses, which issues standards for radio equipment based on the Radio Law of Japan. The first edition of Specified Low-Power Wireless Station - Wireless Equipment for Mobile Object Identification RCR STD-29 was issued in 1992 and revised in July 2003 into Version 3.2.

ASCII

American Standard Code for Information Interchange. American standard character code. This is almost the same as JIS 7-bit code for alphanumeric characters, except that “¥” in the JIS code is “\” in ASCII.

AWG (American Wire Gauge)

Gives the wire gauge. As the AWG number decreases, the wire size increases. For the cable of this product, a use wires that are AWG22 (cross-sectional area: approximately 0.45 mm²) or AWG26 (cross-sectional area: approximately 0.18 mm²).

Circularly polarized waves

Waves with a wave direction of the electrical field (or magnetic field) that is one way and not affected by time and place are called linearly polarized waves. Wave with a wave direction of the electrical field that depends on time and place, i.e., the electrical field rotates in the radio wave transmitting direction, are called elliptically polarized wave. Among elliptically polarized waves, waves with a constant amplitude are called circularly polarized waves.

Command

In this manual, refers to an instruction from the host to the Read/Write Antenna.

Communications

In this manual, refers to data communications between the host and Read/Write Antenna or between an ID Tag and Read/Write Antenna.

Half-duplex communications

Two-way data transmissions in which transmissions can be performed in only one way at a time. In full-duplex communications, data transmissions can be performed in two ways simultaneously.

hex

Hexadecimal number. A method to express a numerical value. The hexadecimal numbering system has a base of 16. The numbers 0 to 9 and characters A to F are used. The characters A to F correspond to decimal numbers 10 to 15.

host

A device, such as personal computer, Programmable Controller (PLC), etc., that sends commands to a Read/Write Antenna.

JIS8

Character code of JIS. There are 8-bit codes and 7-bit codes. JIS 8-bit code is for both alphanumeric characters and Japanese Kana characters.

m/s²

Unit of acceleration based on SI (International System of Units). The old unit is G. 1G = 9.807 m/s².

Microwave

This product uses 2,450 MHz, which is recognized as the IMS band (for industrial, medical and scientific purpose) world-wide.

N•m

Unit of torque based on SI (International System of Units). N is Newton. The old unit is kgf•m. 1 kgf•m = 9.807 N•m.

Response

In this manual, refers to a response returned by a Read/Write Antenna after the host sends a command to the Read/Write Antenna.

RFID

Radio Frequency Identification, i.e., automatic identification with a wireless system. Data about objects is stored in ID Tag memory and the data is read/written by a reader/writer without physical contact.

RS-232C

Common physical interface standard of EIA (Electronics Industries Association). A baud rate of 9,600 bps can be achieved with a communications range of 15 m.

RS-422A

Common physical interface standard of EIA (Electronics Industries Association). RS-422A is superior in noise resistance to RS-232C and a communications range of 3,000 m maximum is supported. Communications are performed through four wires. Two wires are for sending and the other two are for receiving.

RS-485

Common physical interface standard of EIA (Electronics Industries Association). The same line is used for both of sending and receiving, i.e., communications can be made through only two wires.

Second-generation low-power data communications system

Remarkably applicable wireless LAN which was legislated in 1999. The wide frequency band from 2,400 to 2,483.5 MHz can be used by the SS (Spread Spectrum) system and multiple channels are available. ARIB RCR STD-33 (1999) is the Standard.

Sleep, sleep state

The state in which communications with the Read/Write Antenna are not performed. In this state, battery power is used only to back up data in SRAM and the power consumption is 1/100 or less of the state in which the ID Tag operates or communicates. To extend the life of the battery in a ID Tag, we recommend you to put the ID Tag in the sleep state whenever the ID Tag is not operating. When the ID Tag receives radio waves from the Read/Write Antenna, the ID Tag leaves the sleep state and starts operating.

Specified low-power wireless station

A wireless station in which the Antenna power is 10 mW or less. For use in Japan, the user is not required to apply for a license for this type of wireless station. This product has received a Technical Regulation Conformity Certification from an official organization before shipment.

SRAM

Static RAM (Random Access Memory). Volatile memory. Data is backed up by a battery.

Standby, standby state

The state in which all circuits in a Tag are ready to operate as soon as a command is executed. The battery power consumption is the same as that for operations such as communications. Reducing the time a Tag remains in standby state will extend the life of the battery.

Start-stop synchronization

Asynchronous data communications system which does not use a synchronizing clock. Only one communications line is used. Use it when a synchronizing clock cannot be sent.

Tag

In this manual, refers to an ID Tag, which is memory media accessed by the Read/Write Antenna of the RFID System. In technical terms, the Tag is call a transponder.

Terminating resistance

Connected to both ends of a communications line to prevent reflections in the communications line in RS-422A/RS-485 communications.

Time slot

A systems used by the Read/Write Antenna to access several ID Tags. This system adopts a time slot. For example, if "M" (the number of time slots = 16) is specified in the communications designation of a command, the Antenna informs the ID Tags that there are 16 time slots and every ID Tag returns a response according to timing of any of 16 time slots. If responses of several ID Tags collide with each other, the time slots for those Tags are rearranged. For "M", if the number of Tags are approximately 8, the probability of rearrangement is reduced and the total communications time is not prolonged much.

Wake command

A command for identification transmitted every 100 ms when the Read/Write Antenna transmitted radio waves. The ID Tag only identifies it. When the ID Tag receives a wake command, the ID Tag continues operation. If the ID Tag does not receive the wake command, the ID Tag enters sleep state. The ID Tag power-saving function described in Section 4-7 is achieved by utilizing this function.

Appendix 2 JIS 8-bit Code List (ASCII List)

High-order digit Low-order digit	b8~b5	0000	1001	0010	0011	0100	0101	0110	0111	1000	1001	1010	1011	1100	1101	1110	1111
	b4~b1	Column 0	1	2	3	4	5	6	7	8	9	10	11	12	13	14	15
0000	0	NUL	TC ₇ (DLE)	(SP)	0	@	P	Â	â	▲	▲	Undefined	À	É^	É~	▲	▲
0001	1	TC ₁ (SOH)	DC ₁	!	1	A	Q	a	q			Â	ÉA	É`	ÉÄ		
0010	2	TC ₂ (STX)	DC ₂	"	2	B	R	b	r			Â	ÉC	Éc	ÉÅ		
0011	3	TC ₃ (ETX)	DC ₃	#	3	C	S	c	s			Â	ÉE	Ée	ÉÇ		
0100	4	TC ₄ (EOT)	DC ₄	\$	4	D	T	d	t			Â	ÉG	Ég	ÉÑ		
0101	5	TC ₅ (NEQ)	TC ₈ (NAK)	%	5	E	U	e	u			.	ÉI	Éi	ÉÛ		
0110	6	TC ₆ (ACK)	TC ₉ (SYN)	&	6	F	V	f	v			Éí	ÉJ	Éj	Éà		
0111	7	BEL	TC ₁₀ (ETB)	'	7	G	W	g	w	Undefined	Undefined	É@	ÉL	Ék	Éâ	Undefined	Undefined
1000	8	FE ₀ (BS)	CAN	(8	H	X	h	x			ÉB	ÉN	Él	Éä		
1001	9	FE ₁ (HT)	EM)	9	I	Y	i	y			ÉD	ÉP	Ém	Éã	Undefined	Undefined
1010	10	FE ₂ (LF)	SUB	*	:	J	Z	j	z			ÉF	ÉR	Én	Éâ		
1011	11	FE ₃ (VT)	ESC	+	;	K	[k	{			ÉH	ÉT	Éq	Éç		
1100	12	FE ₄ (FF)	IS ₄ (FS)	,	<	L	¥	l				ÉÉ	ÉV	Ét	Éè		
1101	13	FE ₅ (CR)	IS ₃ (GS)	-	=	M]	m	}			ÉÖ	ÉX	Éw	Éì		
1110	14	S0	IS ₂ (RS)	.	>	N	^	n	-			Éá	ÉZ	Éz	ÅJ		▼
1111	15	S1	IS ₁ (US)	/	?	O	_	o	DEL	▼	▼	Éb	É\	É}	ÅK	▼	Undefined

Note 1: The code 01011100 (column 5, row 12) is “\” in ASCII.

Appendix 3 Degree of Protection

• Degree of Protection

◆ IEC (International Electrotechnical Commission) Standards (IEC60529: 1989-11) ◆ JEM (Japan Electrical Manufacturers' Association) Standards (JEM1030: 1991)

IP-□□
Protective property code (Ingress Protection)
Protective classification for 1st digit: Protection from Solid Objects

Class	Protection Level	
0		No protection.
1		Solid foreign material 50 mm or more in diameter (e.g., a hand) cannot enter.
2		Solid foreign material 12.5 mm or more in diameter (e.g., a finger) cannot enter.
3		Solid foreign material 2.5 mm or more in diameter (e.g., a wire) cannot enter.
4		Solid foreign material 1 mm or more in diameter (e.g., a wire) cannot enter.
5		Dust, which interferes a normal operation of device or spoils the safety, cannot enter.
6		Any dust cannot enter.

IP-□□□
Complies with the 1st and 2nd digits of IEC60529.
Protective classification for protection from oil penetration.

Protection Level		
f	Oil retaining type	Not affected considerably by oil drops or oil spray in any direction.
g	Oil resistance type	Any oil drop or oil spray in any direction cannot enter.

NEMA (National Electrical Manufacturers Association)

Table for conversion from NEMA enclosure into IEC60529. (Conversion from IEC60529 into NEMA enclosure is unavailable.)

NEMA250	IEC60529	NEMA250	IEC60529
1	IP10	4, 4X	IP56
2	IP11	5	IP52
3	IP54	6, 6P	IP67
3R	IP14	12, 12K	IP52
3S	IP54	13	IP54

Note: Based on the NEMA Standards. The difference between NEMA enclosure classification and IEC60529 is anticorrosion, rust prevention, condensation on surface, etc.



Protective classification for 2nd digit: Protection from Moisture

Class	Protection Level		Test Method Overview (Test with fresh water)
0	No particular protection	Any particular protection is not taken to water penetration.	No Test.
1	Protection against drops of water	Not to be affected by water dropped vertically.	Drop water for 10 minutes using a water drop tester.
2	Protection against drops of water	Not to be affected by water dropped deviating 15° from a vertical line.	Drop water to an object set inclined 15° for 10 minutes (2.5 minutes per direction) using a water drop tester.
3	Protection against water spray	Not to be affected by water spray deviating within 60° from a vertical line.	Spray water in an area within 60° to the right and left from a vertical line for 10 minutes using a tester shown in this figure. 0.07 L/min per spray nozzle
4	Protection against water splash	Not to be affected by water splash from all the directions.	Spray water from all the directions for 10 minutes using a tester shown in this figure. 0.07 L/min per spray nozzle
5	Protection against water jet flow	Not to be affected by direct water jet flow from all the directions.	Spray water from all the directions for 1 minute per surface area 1 m ² , total 3 minutes or more using a tester shown in this figure. 12.5 L/min Water jet nozzle diameter: 6.3 mm
6	Protection against extreme water jet flow	Not to be affected by extreme direct water jet flow from all the directions.	Spray water from all the directions for 1 minute per surface area 1 m ² , total 3 minutes or more using a tester shown in this figure. 100 L/min Water jet nozzle diameter: 12.5 mm
7	Protection against water soaking *1	Even if an object is immersed in water of specified pressure for a specified time, any water penetration must not be observed.	Immerse an object at 1 m deep in water for 30 minutes (assuming that device height is lower than 850 mm).
8	Protection against water immersion *2	An product must work submersed in water.	According to agreement between a manufacturer and device user.

(January 1998)

Appendix 4 Standard Models

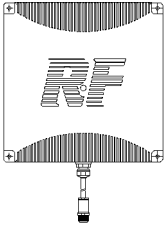
◆ Main Units and System Components

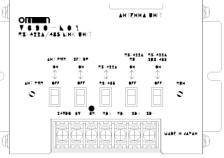
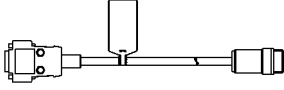
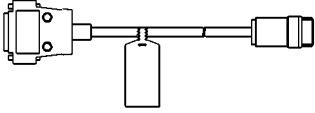
Name/Shape	Specifications	Model
Read/Write Antenna 	RS-232C/RS-422A interface 24 VDC power supply	V690-HMG01A
ID Tag 	Memory capacity: 8 Kbytes Battery life: 5 years (25°C)	V690-D8KR01A
RS-422A/485 Link Unit 	RS-422A/485 interface 24 VDC power supply	V690-L01
RS-232C Connecting Cable (for IBM PC/AT or compatible) 	2 m	V690-A40
	3 m	V690-A41
	5 m	V690-A42
	10 m	V690-A43
	15 m	V690-A44
RS-422A/485 Link Unit Connecting Cable 	2 m	V690-A50
	3 m	V690-A51
	5 m	V690-A52
	10 m	V690-A53
	20 m	V690-A54
	30 m	V690-A55
	50 m	V690-A56

OMRON CORPORATION

Industrial Automation Company

FA Auto-Identification Components Department
Sensing Devices & Components Division H.Q.
Shiokoji Horikawa, Shimogyo-ku,
Kyoto, 600-8530 Japan
Tel: (81)75-344-7069/Fax: (81)75-344-7107

Regional Headquarters

OMRON EUROPE B.V.

Sensor Business Unit,
Carl-Benz-Str. 4, D-71154 Nufringen,
Germany
Tel: (49)7032-811-0/Fax: (49)7032-811-199

OMRON ELECTRONICS, INC.

1 East Commerce Drive, Schaumburg, IL 60173
U.S.A.
Tel: (1)847-843-7900/Fax: (1)847-843-8568

OMRON ASIA PACIFIC PTE. LTD.

83 Clemenceau Avenue,
#11-01, UE Square,
239920 Singapore
Tel: (65)6835-3011/Fax: (65)6835-2711

OMRON CHINA CO., LTD. BEIJING OFFICE

Room 1028, Office Building,
Beijing Capital Times Square,
No. 88 West Chang'an Road,
Beijing, 100031 China
Tel: (86)10-8391-3005/Fax: (86)10-8391-3688

OMRON

Authorized Distributor: