

Heat-resistive RFID System

V680 Series

User's Manual

ID Controller

V680-CA1D

V680-CA2D

Read/Write Antenna

V680-H01

ID Tag

V680-D1KP58HT

Introduction

Thank you for purchasing the V680-series Heat-resistive RFID System. OMRON products are manufactured for use according to proper procedures by a qualified operator and only for the purposes described in this manual. This manual describes the functions, performance, and application methods needed for optimum use of the V680-series Heat-resistive RFID System.

- Please observe the following items when using the RFID System.
- Read and understand this manual before attempting to use the product and use the product correctly.
- Keep this manual in a safe but accessible location so that it is available for reference when required.

Introduction	Application Considerations (Read and understand this information first.)	Introduction
Section 1	Product Overview	Section 1
Section 2	Installation, Connections, and Wiring	Section 2
Section 3	Before Communications	Section 3
Section 4	Reading from/Writing to Tags	Section 4
Section 5	Troubleshooting	Section 5
Section 6	Appendices	Section 6

Heat-resistive RFID System

V680-CA1D	ID Controller
V680-CA2D	ID Controller
V680-H01	Read/Write Antenna
V680-D1KP58HT	ID Tag

User's Manual

READ AND UNDERSTAND THIS DOCUMENT

Please read and understand this document before using the products. Please consult your OMRON representative if you have any questions or comments.

WARRANTY

OMRON's exclusive warranty is that the products are free from defects in materials and workmanship for a period of one year (or other period if specified) from date of sale by OMRON.

OMRON MAKES NO WARRANTY OR REPRESENTATION, EXPRESS OR IMPLIED, REGARDING NON-INFRINGEMENT, MERCHANTABILITY, OR FITNESS FOR PARTICULAR PURPOSE OF THE PRODUCTS. ANY BUYER OR USER ACKNOWLEDGES THAT THE BUYER OR USER ALONE HAS DETERMINED THAT THE PRODUCTS WILL SUITABLY MEET THE REQUIREMENTS OF THEIR INTENDED USE. OMRON DISCLAIMS ALL OTHER WARRANTIES, EXPRESS OR IMPLIED.

LIMITATIONS OF LIABILITY

OMRON SHALL NOT BE RESPONSIBLE FOR SPECIAL, INDIRECT, OR CONSEQUENTIAL DAMAGES, LOSS OF PROFITS OR COMMERCIAL LOSS IN ANY WAY CONNECTED WITH THE PRODUCTS, WHETHER SUCH CLAIM IS BASED ON CONTRACT, WARRANTY, NEGLIGENCE, OR STRICT LIABILITY.

In no event shall responsibility of OMRON for any act exceed the individual price of the product on which liability is asserted.

IN NO EVENT SHALL OMRON BE RESPONSIBLE FOR WARRANTY, REPAIR, OR OTHER CLAIMS REGARDING THE PRODUCTS UNLESS OMRON'S ANALYSIS CONFIRMS THAT THE PRODUCTS WERE PROPERLY HANDLED, STORED, INSTALLED, AND MAINTAINED AND NOT SUBJECT TO CONTAMINATION, ABUSE, MISUSE, OR INAPPROPRIATE MODIFICATION OR REPAIR.

SUITABILITY FOR USE

THE PRODUCTS CONTAINED IN THIS DOCUMENT ARE NOT SAFETY RATED. THEY ARE NOT DESIGNED OR RATED FOR ENSURING SAFETY OF PERSONS, AND SHOULD NOT BE RELIED UPON AS A SAFETY COMPONENT OR PROTECTIVE DEVICE FOR SUCH PURPOSES. Please refer to separate catalogs for OMRON's safety rated products.

OMRON shall not be responsible for conformity with any standards, codes, or regulations that apply to the combination of products in the customer's application or use of the product.

At the customer's request, OMRON will provide applicable third party certification documents identifying ratings and limitations of use that apply to the products. This information by itself is not sufficient for a complete determination of the suitability of the products in combination with the end product, machine, system, or other application or use.

The following are some examples of applications for which particular attention must be given. This is not intended to be an exhaustive list of all possible uses of the products, nor is it intended to imply that the uses listed may be suitable for the products:

- Outdoor use, uses involving potential chemical contamination or electrical interference, or conditions or uses not described in this document.
- Nuclear energy control systems, combustion systems, railroad systems, aviation systems, medical equipment, amusement machines, vehicles, safety equipment, and installations subject to separate industry or government regulations.
- Systems, machines, and equipment that could present a risk to life or property.

Please know and observe all prohibitions of use applicable to the products.

NEVER USE THE PRODUCTS FOR AN APPLICATION INVOLVING SERIOUS RISK TO LIFE OR PROPERTY WITHOUT ENSURING THAT THE SYSTEM AS A WHOLE HAS BEEN DESIGNED TO ADDRESS THE RISKS, AND THAT THE OMRON PRODUCT IS PROPERLY RATED AND INSTALLED FOR THE INTENDED USE WITHIN THE OVERALL EQUIPMENT OR SYSTEM.

PERFORMANCE DATA

Performance data given in this document is provided as a guide for the user in determining suitability and does not constitute a warranty. It may represent the result of OMRON's test conditions, and the users must correlate it to actual application requirements. Actual performance is subject to the OMRON Warranty and Limitations of Liability.

CHANGE IN SPECIFICATIONS

Product specifications and accessories may be changed at any time based on improvements and other reasons.

It is our practice to change model numbers when published ratings or features are changed, or when significant construction changes are made. However, some specifications of the product may be changed without any notice. When in doubt, special model numbers may be assigned to fix or establish key specifications for your application on your request. Please consult with your OMRON representative at any time to confirm actual specifications of purchased products.

DIMENSIONS AND WEIGHTS

Dimensions and weights are nominal and are not to be used for manufacturing purposes, even when tolerances are shown.

ERRORS AND OMISSIONS

The information in this document has been carefully checked and is believed to be accurate; however, no responsibility is assumed for clerical, typographical, or proofreading errors, or omissions.

PROGRAMMABLE PRODUCTS

OMRON shall not be responsible for the user's programming of a programmable product, or any consequence thereof.

COPYRIGHT AND COPY PERMISSION

This document shall not be copied for sales or promotions without permission. This document is protected by copyright and is intended solely for use in conjunction with the product. Please notify us before copying or reproducing this document in any manner, for any other purpose. If copying or transmitting this document to another, please copy or transmit it in its entirety.

Safety Precautions

Alert Symbols for Safe Use

The following symbols are used in this manual to indicate precautions that must be observed to ensure safe use of the V680 Series. The precautions provided here contain important safety information. Be sure to observe these precautions.

The following signal words are used in this manual.



Warning

Indicates a potentially hazardous situation which, if not avoided, will result in minor or moderate injury, or may result in serious injury or death. Additionally, there may be significant property damage.

Meanings of Alert Symbols



Indicates general prohibitions for which there is no specific symbol.

Warning



Warning

This product is not designed to be used either directly or indirectly in applications that detect human presence for the purpose of maintaining safety. Do not use this product as a sensing device for protecting human lives.



Regulations and Standards

The V680-CA1D and V680-CA2D conform to the following overseas regulations and standards.

1. EC Directives

EN55022

EN55024

The V680-H01 conforms to the following overseas regulations and standards.

1. European Wireless/EMC Standards

EN 300 330 (1999)

ETS 300683 (1997)

EN 60065

2. FCC Rules (Federal Communications Commission)

FCC Part 15 Subpart C

3. Japan Radio Law

Equipment using high frequencies: Inductive Reading/Writing Communications Equipment, Identification No. EC-04023

Conforming standards: Inductive Reading/Writing Communications Equipment; Standard: ARIB STD-T82

Model specifications for the Heat-resistive RFID System apply only for use in combination with an ID Controller.

Precautions for Safe Use

Be sure to observe the following precautions to ensure safe use of the product.

1. Do not use the product in environments with flammable, explosive, or corrosive gasses.
2. Do not attempt to disassemble, repair, or modify the product.
3. Tighten the base lock screws and terminal block screws securely.
4. Make sure that the split pin is installed correctly to prevent the product from becoming detached.
5. Be sure to use crimp terminals of the specified size for wiring.
6. If any cable has a locking mechanism, make sure that it has been locked before using it.
7. The DC power supply must satisfy the following requirements.
 - The DC power supply must be used for the V680 Series only and must not be connected to any other devices or equipment.
 - The voltage of the DC power supply must be within the specified rating (24 VDC +10%/–15%).
8. Install the ferrite cores provided with the V680-CA1D and V680-CA2D according to the instructions. Do not remove the ferrite core installed on the V680-H01.
9. Do not touch the product immediately after usage at high temperatures. Doing so may occasionally result in burning.
10. If the system is producing abnormal odors or if the product becomes abnormally hot, emits smoke, or exhibits any other abnormal condition, immediately stop using the system, turn OFF the power, and contact your OMRON representative.
11. Disposing of the product as industrial waste.
12. Observe all warnings and precautions given in the body of this manual.

Precautions for Correct Use

Always observe the following precautions to prevent operation failures, malfunctions, and adverse effects on performance and equipment.

1. Installation Environment

Do not install the V680-CA1D, V680-CA2D, or V680-H01 in any of the following locations.

- Locations exposed to direct sunlight
- Locations exposed to corrosive gases, dust, metallic powder, or salts
- Locations not within the specified operating temperature range
- Locations subject to rapid changes in temperature (with no condensation)
- Locations not within the specified humidity range
- Locations subject to direct vibration or shock outside the specified ranges

2. ID Tag Installation

- The product communicates with Tags using the 13.56-MHz frequency band. Some transceivers, motors, monitoring devices, power supplies (e.g., power supply IC), and devices in similar RFID systems generate noise that can affect communications with the Tags. If such devices are located near the Tags, always test operation in advance to confirm whether the system will be affected.
- Observe the following precautions to minimize the effects of normal noise.

(1) Ground all metal objects in the vicinity to 100 Ω or less.

(2) Do not use the system near high-voltage or high-current lines.

Do not install the system near radio astronomy or medical equipment, which may be adversely affected.

3. Power Supply and Grounding

- Be sure to use the power supply voltage specified in this manual.
- Do not reverse the polarity of the power supply terminals.
- Ground the ground terminal to 100 Ω or less.

4. Wiring

- Always turn OFF the power before performing wiring or connecting/disconnecting cables.
- Do not wire the lines of the RFID System alongside high-tension lines or power lines.
- To prevent damage from static electricity, use a wrist strap or another device for preventing electrostatic charges when touching terminals or signal lines.

5. Cleaning

- Do not clean the product with thinners, benzene, or other organic solvents.

How to Read this Manual

Meanings of Symbols



CHECK!

Indicates particularly important points related to a function, including precautions and application advice.



Indicates page numbers containing relevant information.



Indicates reference to helpful information and explanations for difficult terminology.

Table of Contents

Safety Precautions	3
Regulations and Standards	3
Precautions for Safe Use	4
Precautions for Correct Use	5
How to Read this Manual	6
Table of Contents	7
<hr/>	
Section 1 Product Overview	9
<hr/>	
System Configuration	10
Operation Overview	12
Component Names and Functions	13
Operation Flowchart	15
<hr/>	
Section 2 Installation, Connections, and Wiring	17
<hr/>	
Installation Environment	18
Installation Method	20
Connecting and Removing the Antenna Connector	24
Wiring	25
RS-232C Interface Connections (V680-CA1D)	29
RS-485 Interface Connection (V680-CA2D)	33
<hr/>	
Section 3 Before Communications	37
<hr/>	
Switch Settings	38
Communications Test	42
<hr/>	

Section 4 Reading from/Writing to Tags	45
Tag Operation and Command Status	46
Tag Memory Map	50
Command and Response Format	56
Communications Commands	62
Communications Subcommands	72
Controller Control Commands	73
Other Commands	76
Section 5 Troubleshooting	77
Self-diagnostic Function	78
Errors and Countermeasures	79
Maintenance and Inspection	80
Troubleshooting	81
Section 6 Appendices	87
Specifications and Dimensions	88
Characteristics According to Operating Conditions	98
JIS8 Unit Code Table (ASCII)	105
Degree of Protection	106
Revision History	109

Section 1

Product Overview

☒ System Configuration	10
☒ Operation Overview	12
☒ Component Names and Functions	13
☒ Operation Flowchart	15

System Configuration

Example of V680-CA1D System Configuration

The V680-CA1D contains a serial interface based on RS-232C and can connect easily to a general-purpose personal computer and Programmable Controller (PLC). Standard communications are performed by executing instructions from any host device.

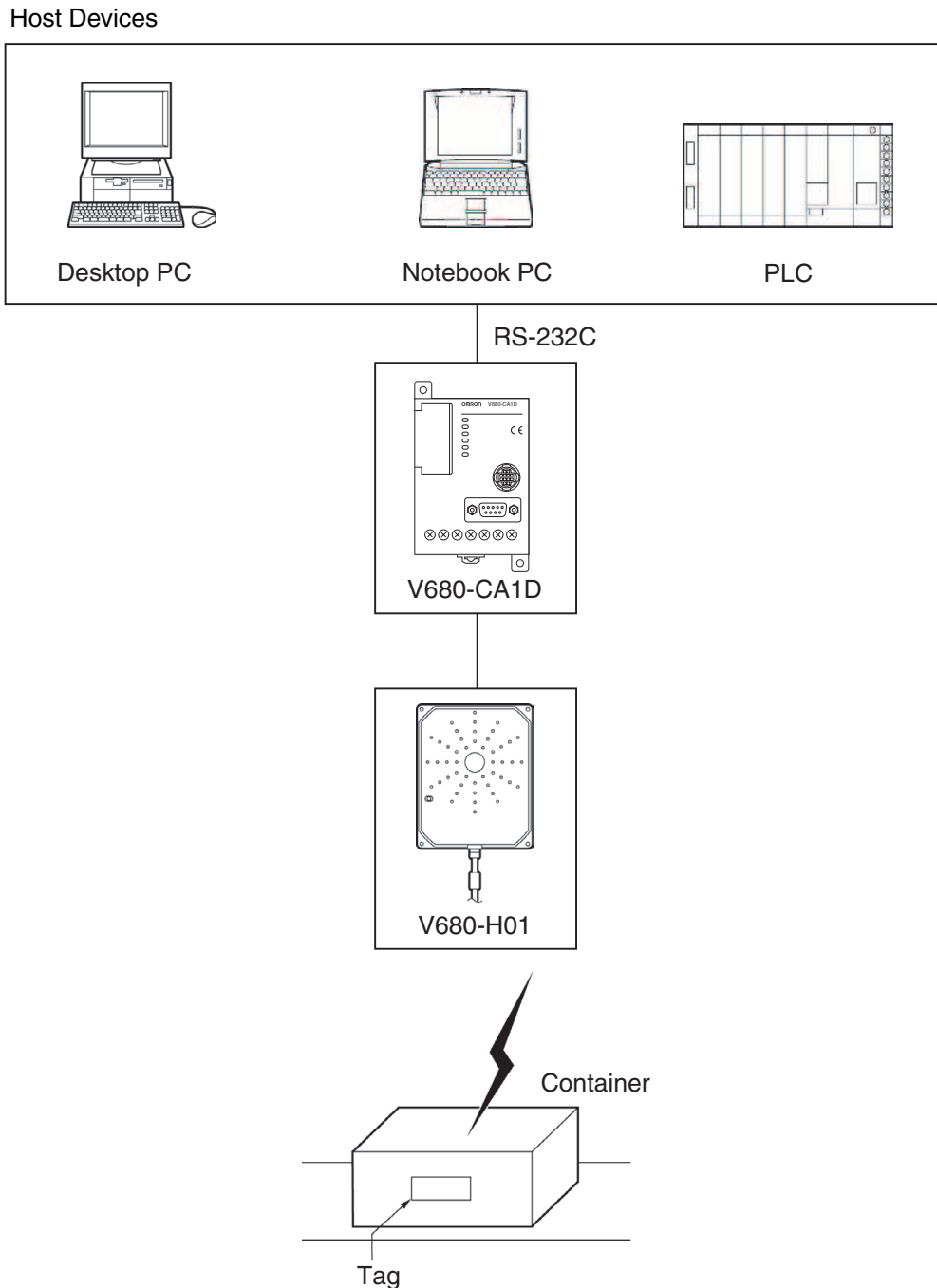

Example of V680-CA2D System Configuration

The V680-CA2D contains a serial interface based on RS-232C enabling connection of up to ten Controllers to a single host device such as a general-purpose personal computer or Programmable Controller (PLC). The RS-485 cable can be extended up to a total length of 300 m.

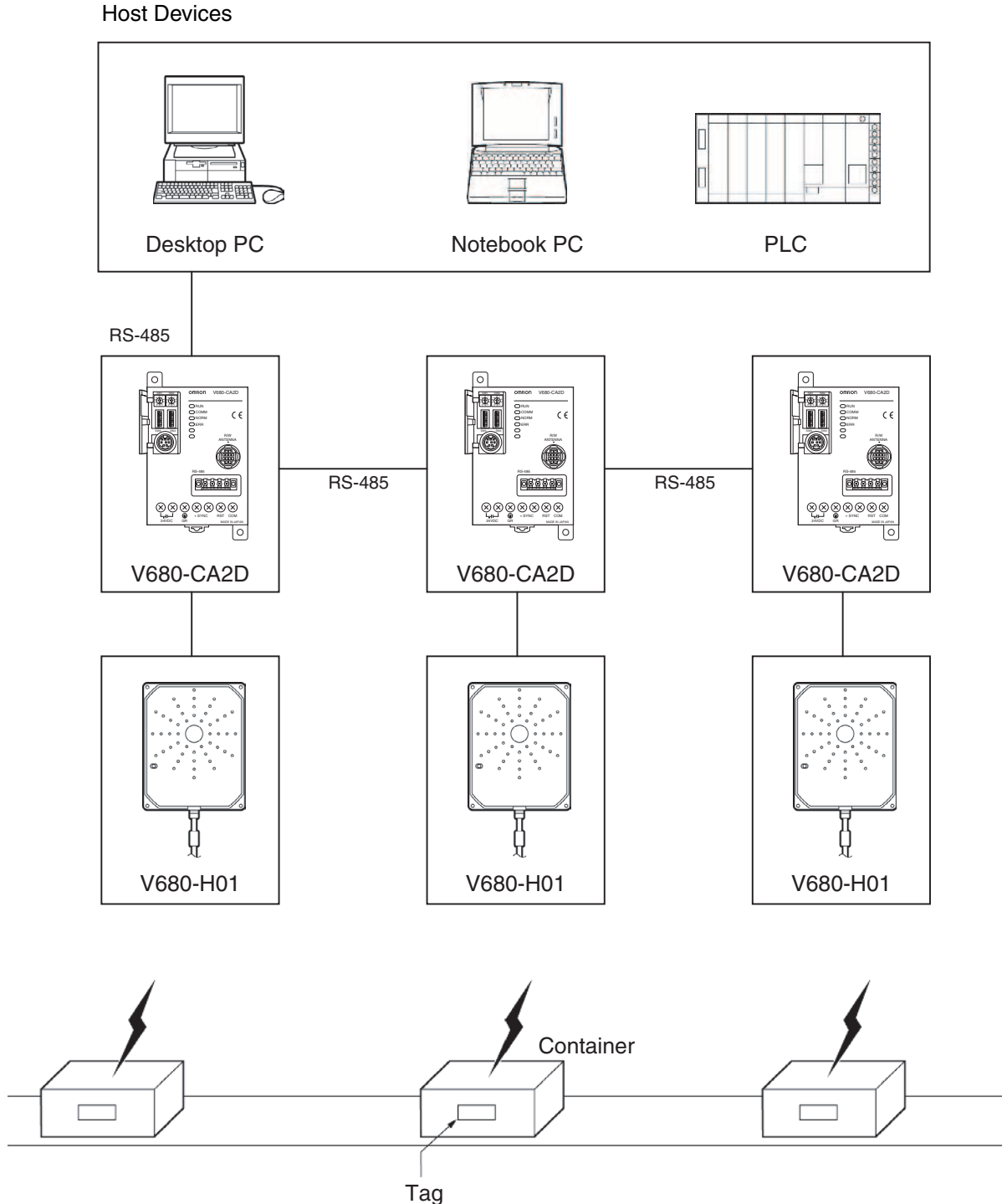

When connecting the Controller and host device together using an RS-232C/485 Adapter and two-wire communications, change to receiving mode within 5 ms after the command has been completely sent to the Controller from the host device. Otherwise, communications with the Controller may not be possible.

Operation Overview

An overview of the operation is described using an example of sorting containers or other objects with Tags depending on the information contained in the Tags.

Host Devices

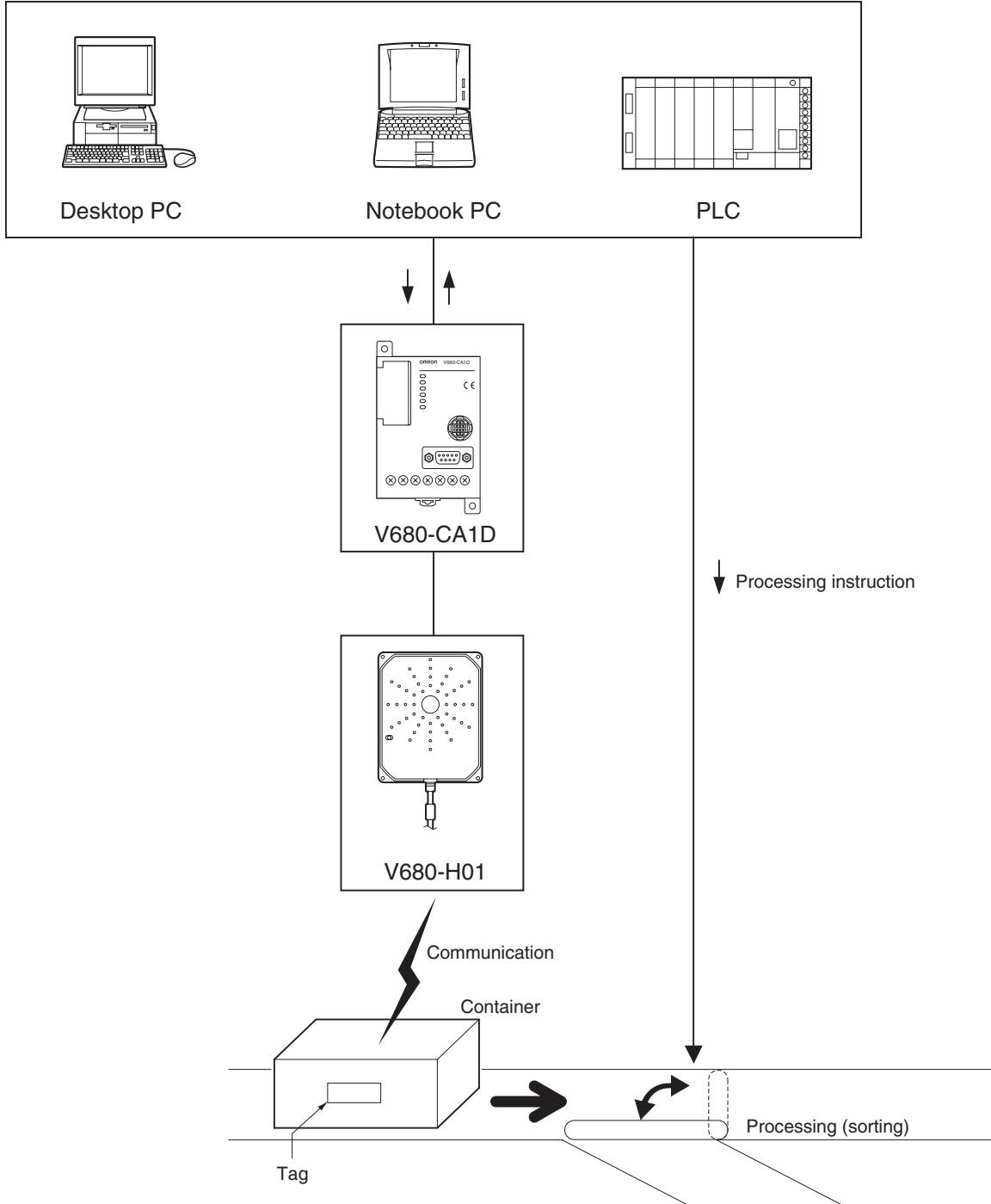

- (1) When the command is sent to the Controller from the host device, the antenna waits for a Tag to arrive.
- (2) When the Tag enters the antenna's communications area, the data in the memory area specified in the READ command is returned to the host device as a response.
- (3) The host device performs processing (e.g., sorting) based on this data.

Component Names and Functions

V680-CA1D

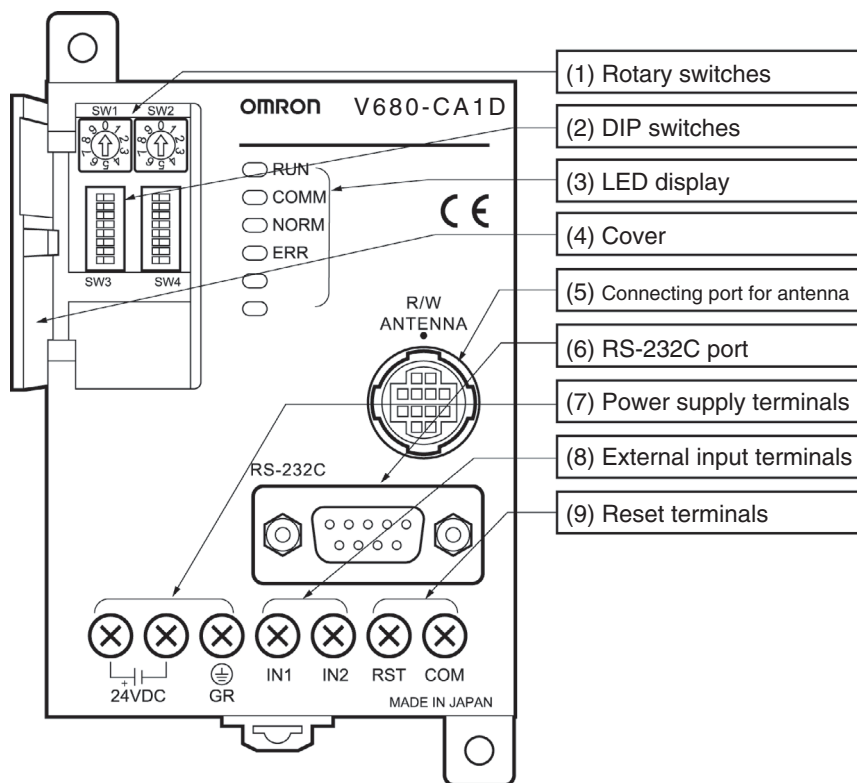

V680-CA2D

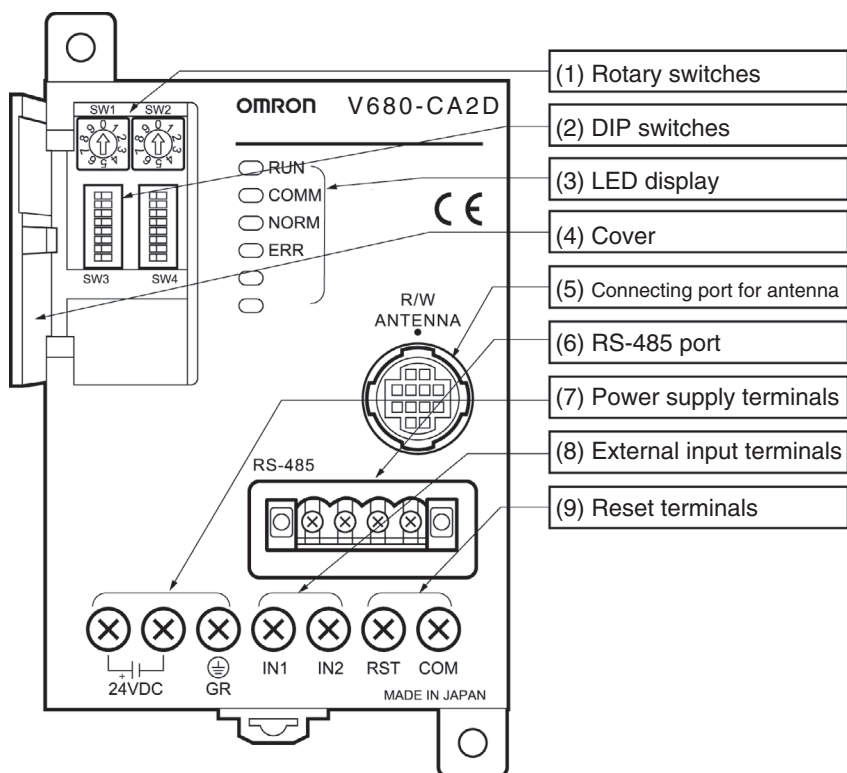

• Overview of Parts

No.	Name	Function	Description
(1)	Rotary switches	Sets a controller node number (SW1).	Used to identify each of the Controllers when multiple Controllers (10 max.) are connected to one host computer.
(2)	DIP switch	Sets every mode.	Sets the mode settings, such as terminating resistance, baud rate, data length, parity, and number of stop bits.
(3)	LED display	The operation status is shown on the LED.	
	RUN	Green	Indicates the RUN status Lit when operation is normal.
	COMM	Green	Indicates the operation status Lit during communication with Tag.
	NORM	Green	Indicates the end of operation Lit once when communication is completed and then turns OFF.
	ERR	Red	Error display Lit once when communications ends in an error and then turns OFF. Also lit when a system error occurs.
(4)	Cover	Cover for (1), (2), and (5)	Open only when required for use.
(5)	Connecting port for antenna	Connects an antenna.	A single antenna can be connected via a V700-A40-W Antenna Cable (order separately). Applicable Antenna: V680-H01 (250 × 200 mm)
(6)	RS-232C port (V680-CA1D)	Connects a host device.	A general-purpose PLC or personal computer with RS-232C interface can be connected.
	RS-485 port (V680-CA2D)	Connects a host device.	A general-purpose PLC or personal computer with RS-485 interface can be connected.
(7)	Power supply terminal	Terminal for power supply.	
	24 VDC+	Supplies the power.	Connects the "+" side of 24 VDC power supply.
	24 VDC-		Connects 0 V.
	GR	Ground	Ground to 100 Ω or less.
(8)	External input terminal	User input signal	The status can be read depending on the command.
(9)	RESET terminal	RESET-related terminal	
	RST	RESET signal	Connected as a pair when using the external reset input.
	COM	COMMON signal	

Operation Flowchart

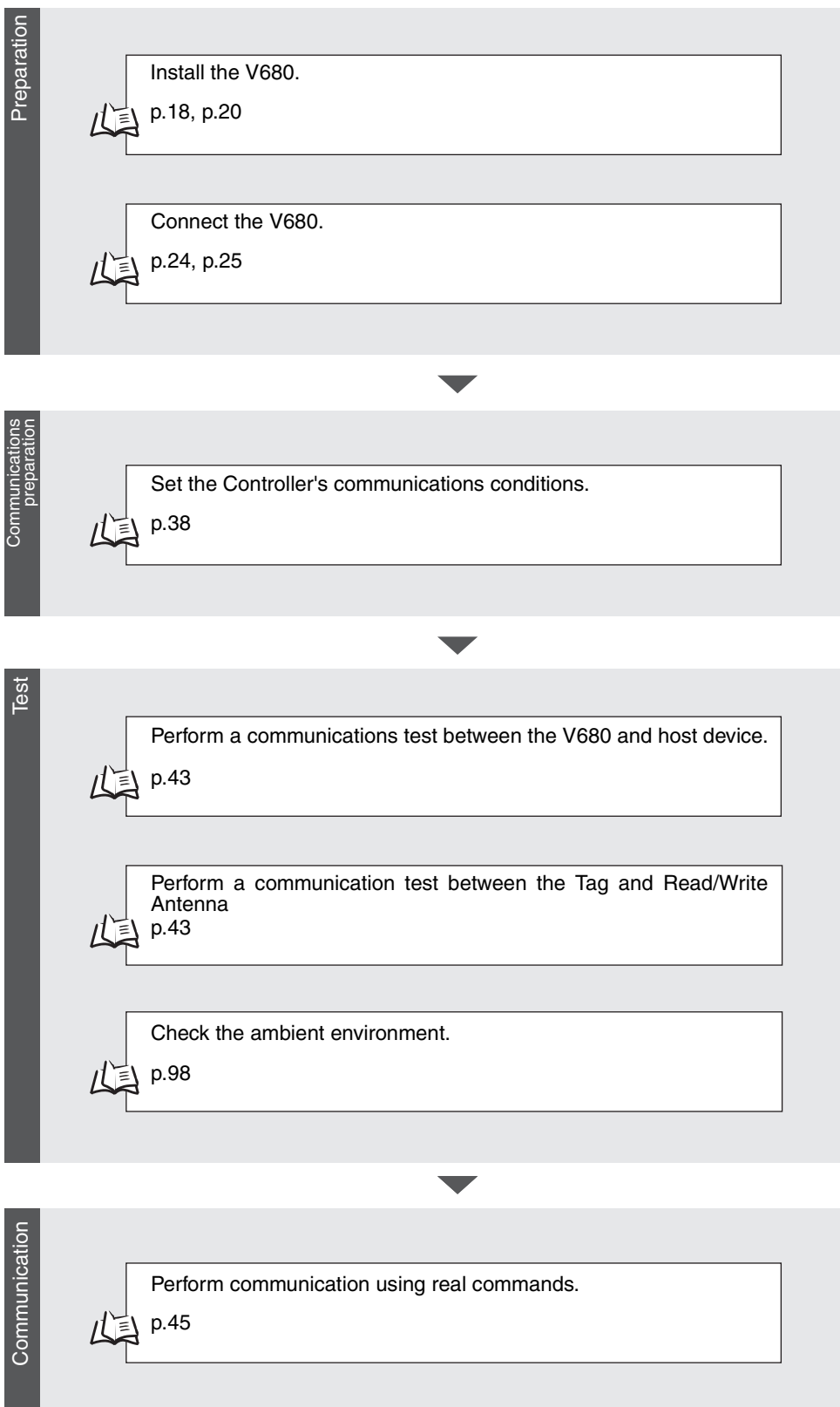

MEMO

Section 2

Installation, Connections, and Wiring

☒ Installation Environment	18
☒ Installation Method	20
☒ Connecting and Removing the Antenna Connector	24
☒ Wiring	25
☒ RS-232C Interface Connections (V680-CA1D)	29
☒ RS-485 Interface Connection (V680-CA2D)	33

Installation Environment

Controller

The V680-CA1D and V680-CA2D Controllers are highly reliable control devices that can withstand harsh environments. To increase the reliability of the system and ensure full functionality, however, install the Controller according to the instructions below.

• Installation Site

Do not install the Controller in the following locations.

- Locations exposed to ambient temperatures that are not within the range between -10°C and 55°C or where there are radical temperature changes resulting in condensation
- Locations exposed to humidity that is not within a range between 35% and 85%
- Locations subject to corrosive gas, flammable gas, dust, salt, or metal powder
- Locations that will expose the Controller to direct vibration or shock
- Locations exposed to direct sunlight
- Locations exposed to water, oil, or chemicals sprays

• Mounting in Panel

The Controller can be used at an ambient temperature range between -10°C and 55°C . Be sure to observe the following precautions.

- Make sure that the Controller is provided with sufficient ventilation space.
- Do not install the Controller close to heaters, transformers, or large-capacity resistors that radiate excessive heat.
- If the ambient temperature exceeds 55°C , be sure to install a forced-ventilation fan or cooler to keep the temperature below 55°C .
- If power lines or high-tension lines with large currents (e.g., for driving motors) are located close to the Controller, to reduce the affect of noise be sure to test the Controller thoroughly and check the Controller's wiring conditions.



CHECK!

Be sure to observe the above precautions before installing the Controller and carefully test the Controller before actual use.

Read/Write Antenna

The V680-H01 Read/Write Antenna is a highly reliable control device that can withstand harsh environments. To increase the reliability of the system and ensure full functionality, however, install the Antenna according to the instructions below.

• Installation Site

Do not install the Antenna in the following locations.

- Locations exposed to ambient temperatures not within the range between -20°C and 55°C or locations with radical temperature changes resulting in condensation
- Locations exposed to humidity that is not within the range between 35% and 85%
- Locations subject to corrosive gas, flammable gas, dust, salt, or metal powder
- Locations that will expose the Antenna to direct vibration or shock

• Ambient Environment

The communications distance of the Antenna drops due to ambient noise from surrounding electronic devices.

The following precautions apply when installing the Antenna near such devices or other sources of ambient noise.

• Power Lines and High-tension Lines

Do not wire the Antenna cable along with high-tension lines or power lines. Keep the Antenna cable as far away as possible from them.

• Inverters, Motors, and Other Driving Mechanisms

Be sure to ground the frames of driving mechanisms and keep them as far away as possible from the Antenna.

• Switching Power Supplies and Other Power Supplies

Be sure to ground switching power supplies and keep them as far away as possible from the Antenna.



CHECK!

Be sure to observe the above precautions before installing the Antenna and carefully test the Antenna before actual use.

Tags

• Installation Site

Do not install Tags in the following locations.

- Locations subject to corrosive gas, flammable gas, or metal powder



CHECK!

Be sure to observe the above precautions before installing the Tag and carefully test the Tag before actual use.

Installation Method

Controllers

The Controller can be mounted to a DIN Track or mounted directly into a panel with screws.

- Mounting Directly in a Panel

Be sure to secure the Controller with two M4 screws together with spring washers and flat washers when enclosing the Controller in a panel.

Do not use any organic solvent such as lock paint to fix screws. Otherwise, the case may crack.

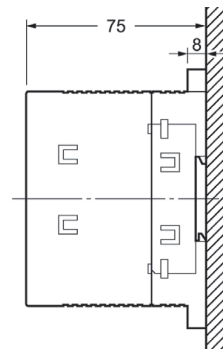
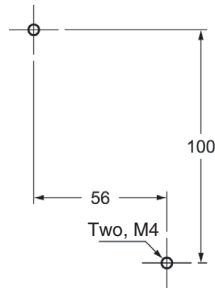

- Mounting to a DIN Track

1. First hook the Controller to part A, and then press the Controller in direction B to mount the Controller to the DIN Track.

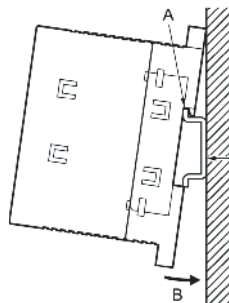

DIN Track
OMRON PFP-100N2 (track length: 1 m)
is recommended.

DIN Track height: 80 mm max.

PEF-100N2 DIN Track

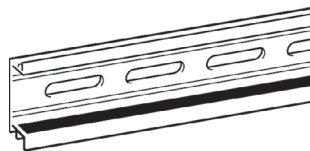

PFP-M End Plate

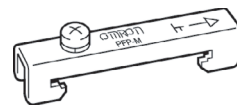

2. To disconnect the Controller from the DIN Track, pull the mounting hook downwards, and then lift the Controller upwards.

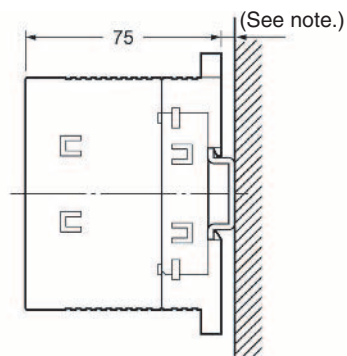
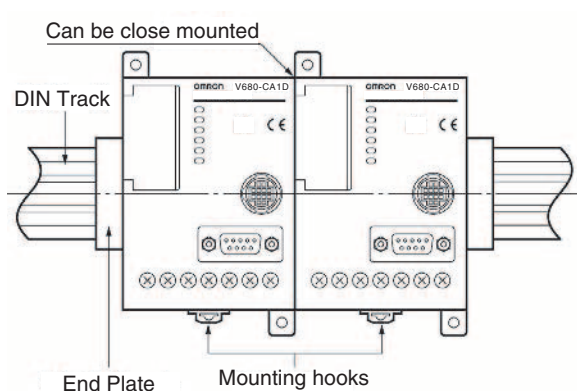

Note: Consider the height of the DIN Track when mounting.

Read/Write Antenna

Be sure to insert the provided fittings into the Antenna mounting holes and mount the Antenna with four M4 screws with spring washers and flat washers as shown below.

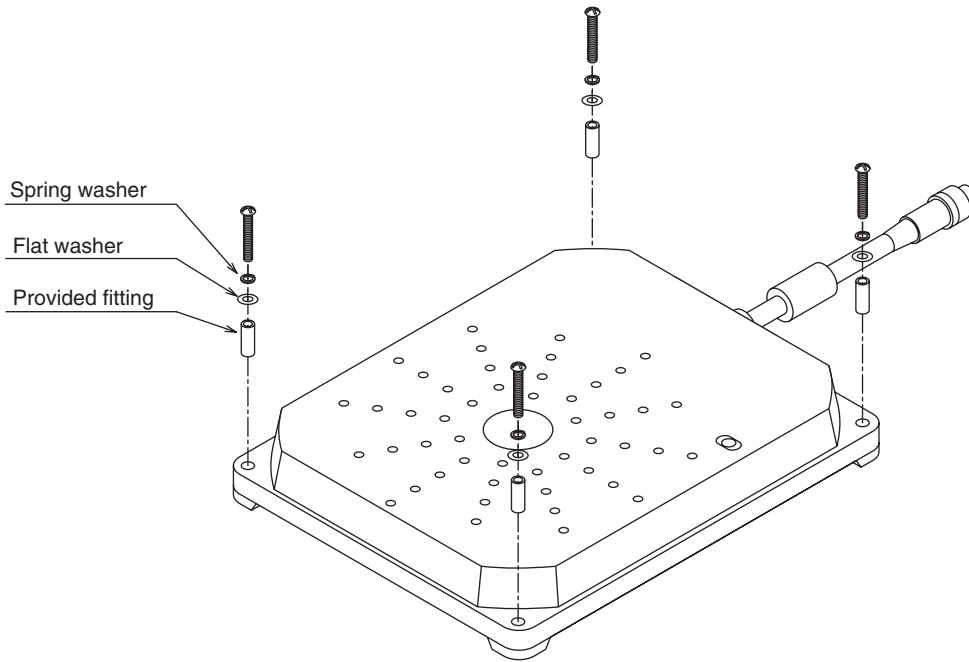

Mounting Hole Dimensions

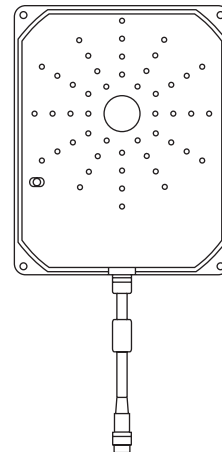
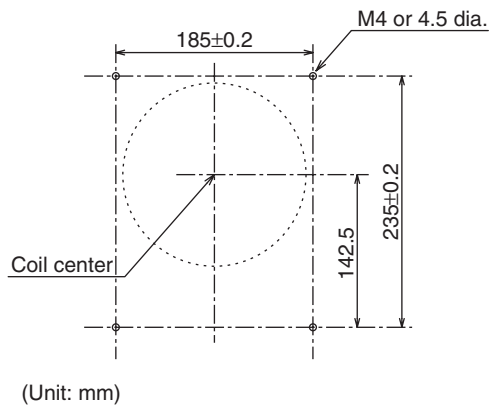

Tags

The Tags have a limited life span. Therefore, install them in locations in which they can be easily replaced. Use the following procedure to mount the V680-A80 Attachment when required.

1. Mount the Attachment to the workpiece.



Use a tightening torque of 21 to 42 N-m.

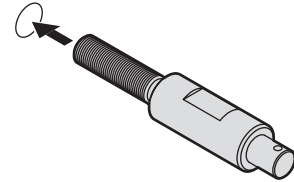

2. Tighten the lock nut.

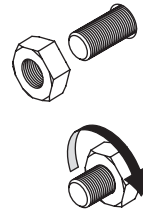

3. Mount the Tag to the Attachment.



The Tag can be mounted in either direction.

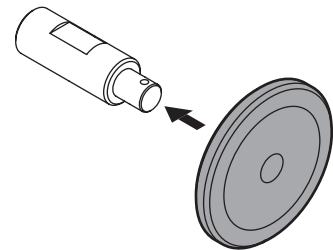

4. Insert the split pin into the 3.2-dia. hole and open the tip of the pin to secure.

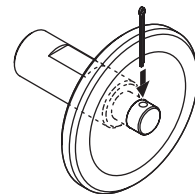

Two nuts and one split pin are provided with the V680-A80 Attachment. Replacement split pins must be provided by the user.

Split pin	Nominal: 3.2 mm × 20 mm (length)
-----------	----------------------------------

Connecting and Removing the Antenna Connector

A single Antenna can be connected to the Controller. A V700-A40-W Antenna Cable (order separately) is normally required to connect the Antenna. Cables with a length of up to 30 m are available.

Connecting and Removing the Connector

• Connecting

1. Hold the connector cable locking section, and insert matching the black mark on the Controller with the white mark on the connector.
2. Push the connector in vertically until it locks.



CHECK!

Be sure to grip the cable locking section. The connector will not lock if only the ring section is pushed.

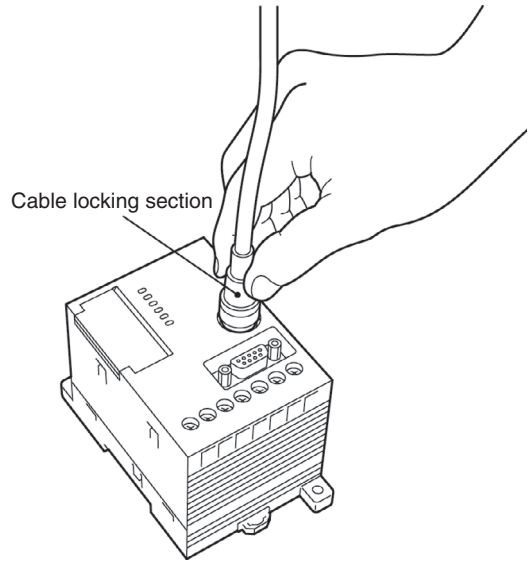

• Removing

1. Grip the ring section and pull the connector out vertically.



CHECK!

The cable cannot be removed if the cable locking section is gripped.
Never pull excessively on the cable. Doing so will cause broken wires and damage.



CHECK!

Do not remove or connect the connector when the power is turned ON. Doing so will cause a malfunction.

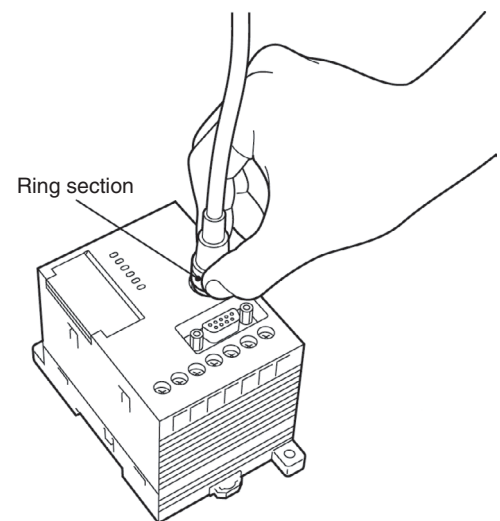

Wiring

Wire the Controller as shown below.

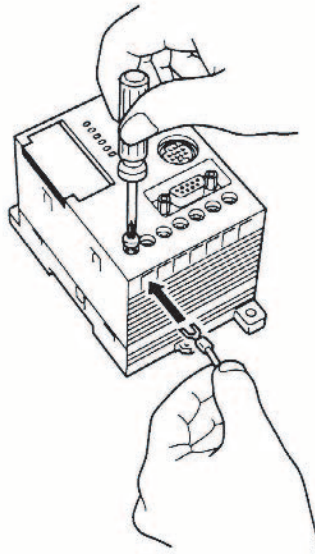

Power Supply and Ground Wires

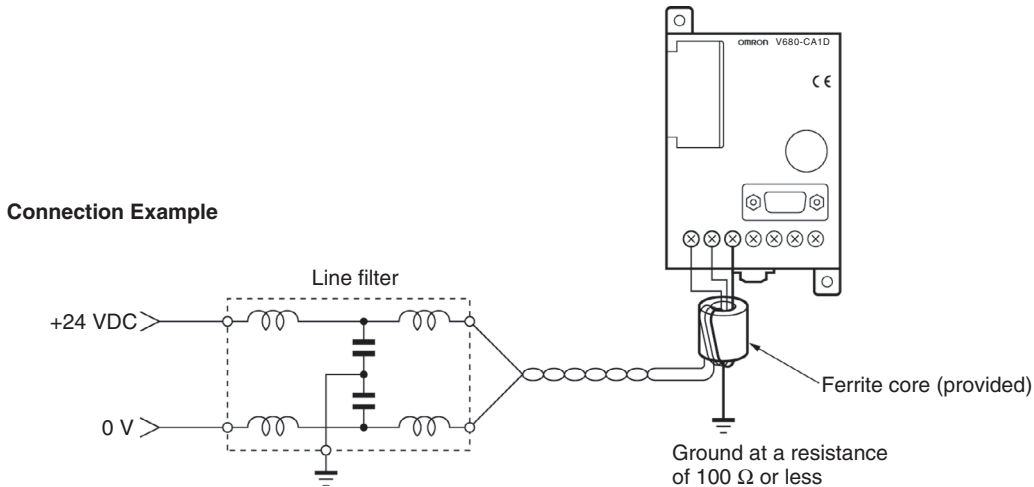

- The power supply and ground terminals use M3 self-rising screws. The following type of crimp terminals can be connected to these terminals. Tighten each screw to a torque of approximately 6 kgf·cm.

Examples of Applicable Crimp Terminals

Manufacturer	Model	Applicable wire	Type
J.S.T. Mfg. Co., Ltd.	1.25-N3A	AWG24 to AWG16	Fork-shaped
J.S.T. Mfg. Co., Ltd.	1.25-Y3A		

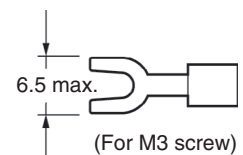

- The Controller can internally withstand the noise on the power line. By providing power to the Controller through the noise filter, however, the noise between the Controller and ground can be greatly reduced.

Recommended Compact DC Power Supply (OMRON)

Model	Output capacity	Input voltage
S82K-03024	24 VDC 1.3 A	100 V 24 VDC
S82J-0224	24 VDC 1.1 A	100 V

* The maximum power consumption of the Controller is 20 W (i.e., 0.8 A at 24 VDC). The inrush current, however, must be considered when selecting the power supply capacity. A power supply with an output of 1.1 A min. at 24 VDC is recommended.

Correct Use

- If the Antenna and power supply are too close, some noise generated from the power supply may interfere with communication. Make sure that there is a distance of 1 m or more between the Antenna and power supply.
- If the Controller and Antenna are too close, the Controller may interfere with the communication between the Antenna and ID Tag. Make sure that there is a distance of 80 cm or more between the Controller and Antenna.

Note

- Provide 24 VDC to the Controller. The allowable fluctuation of the power supply is between 20.4 and 26.4 VDC (i.e., 24 VDC $-15\%/+10\%$). Make sure that the power supply voltage is within this range.
- The maximum power consumption of the Controller in the largest configuration is 20 W. An inrush current of approximately 30 A at 24 VDC, however, flows when the Controller is turned ON. Take this into consideration when preparing the power supply.
- Provide a power wire with a thickness of at least AWG18 to prevent voltage drops. Twisted-pair wire is recommended for the power line.
- Ground the Controller at a resistance of 100 Ω or less to protect the Controller from noise interference. The thickness of the ground wire must be at least AWG18.

Use the provided ferrite core for the suppression of noise generation as shown below.

1. Wire the power supply and ground wires in advance.

2. Wind the power supply and ground wires together around the ferrite core once so that the ferrite core will not move as shown below. As a guide, locate the ferrite core within 10 cm of the Controller.

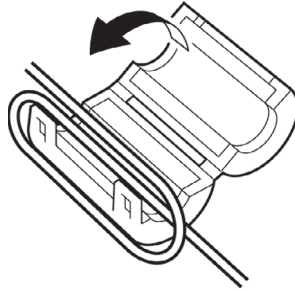

3. Close and press the ferrite core until it clicks, indicating that the ferrite core is locked.

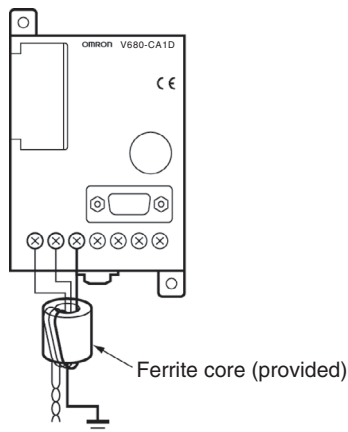

Wiring the RESET Signal and External Input Signals (IN1 and IN2)

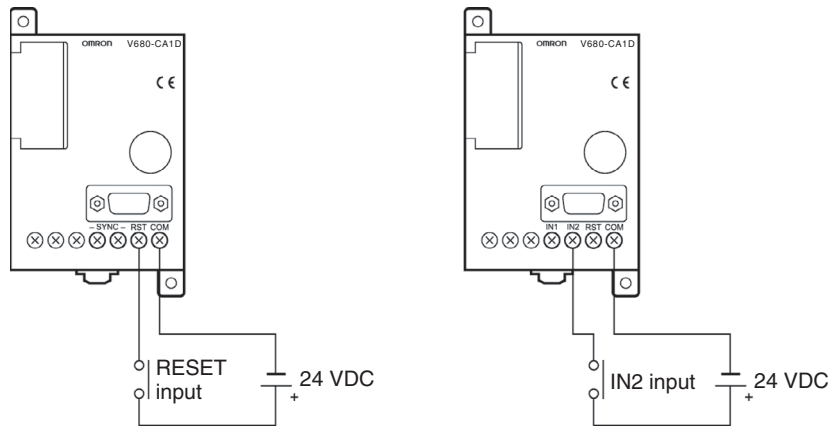

• Crimp Terminals

The I/O terminals use M3 self-rising screws. The following type of crimp terminals can be connected to these terminals.

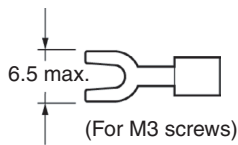

Tighten each screw to a torque of approximately 6 kgf-cm.



Make sure that the input voltage does not exceed a maximum allowable input voltage of 26.4 V, otherwise the Controller may malfunction.

CHECK!



Separate power lines and high-tension lines from the input line to protect the input line from noise interference.

CHECK!

RS-232C Interface Connections (V680-CA1D)

Signal name	Symbol	Signal direction		Pin No.
		Input	Output	
Ground for maintenance or ground	GR	No	No	Shield
Signal ground or common retrace line	SG	No	No	5
Send data	SD	No	Yes	3
Receive data	RD	Yes	No	2
Request to send	RS	No	Yes	7
Clear to send	CS	Yes	No	8

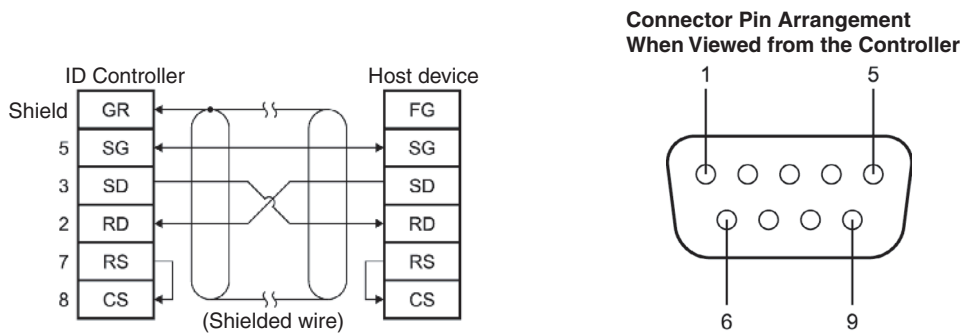

Note 1. Ground the shielded wire on either the Controller side or the host device side to prevent operation errors.

Note 2. Internally short-circuit pins 7 (RS) and 8 (CS).

- Connection to Host Device via IBM PC/AT or Compatible Computer, 9-pin Port

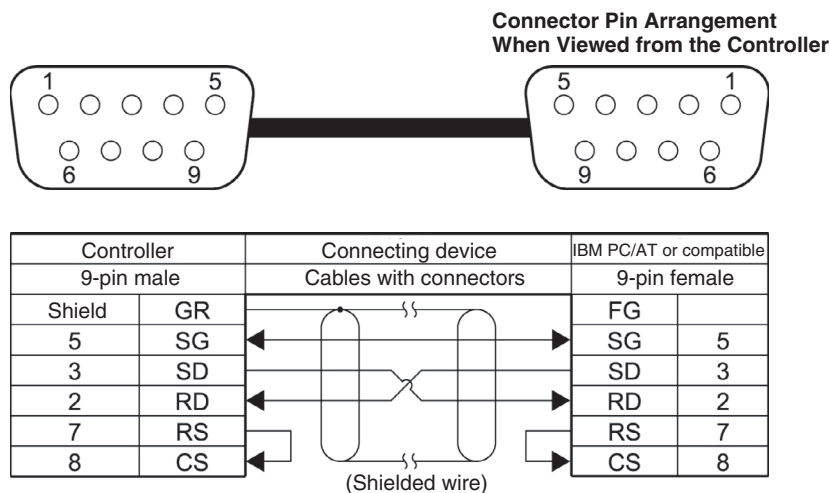

• **Connecting to OMRON C200H PLC**

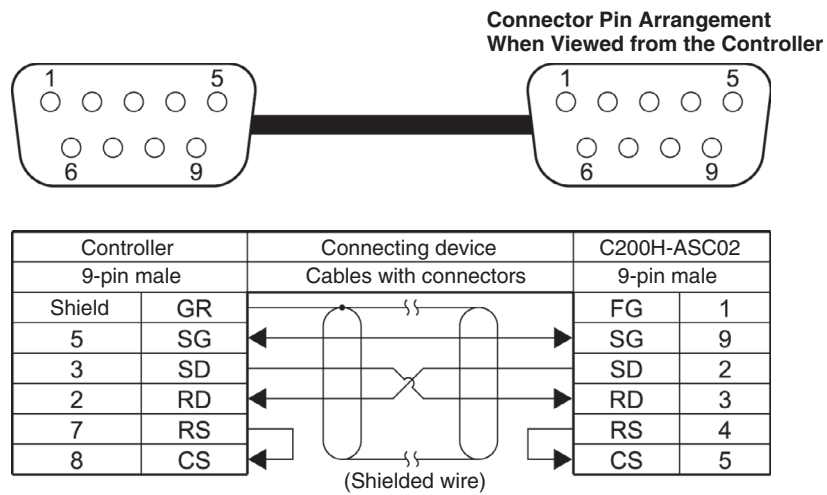

• **Assembly and Connection of Communications Connector**

Use the OMRON communications connector conforming to EMI standards that is provided with the Controller. Prepare a connection cable and a connector for the host device.

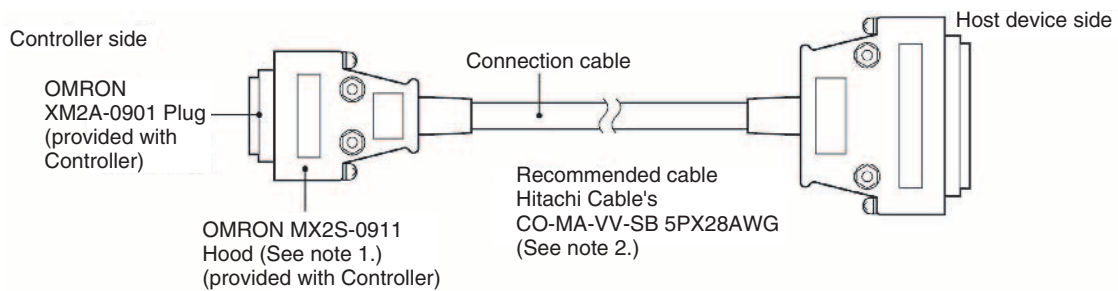

Note 1. One set of connectors conforming to EMI standards is provided with the Controller.

Note 2. Use the above cable or an equivalent one with an external diameter of 7 mm.

• Assembling the Connector

1. Prepare the end of the cable as shown below.

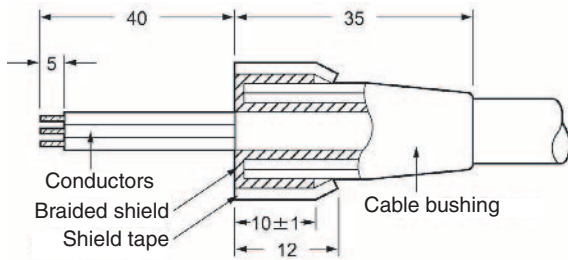

- Insert the cable into the cable bushing.
- Unravel the braided shield for approximately 10 mm and fold it back on the cable bushing.
- Apply shield tape to the folded braided shield.

2. Solder the conductors to the plug pins.

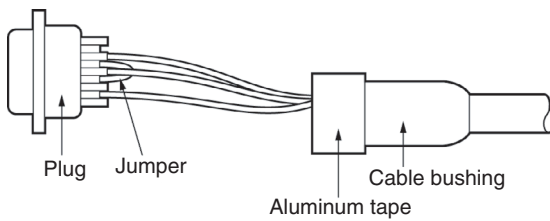

Pin No.	Symbol	Name
Shield	GR	Ground
5	SG	Signal ground
3	SD	Send data
2	RD	Receive data
7 (See note.)	RS	Request to send
8 (See note.)	CS	Clear to send

Note: Short-circuit pins 7 (RS) and 8 (CS) with a jumper.

3. Attach housing A2 of the Hood to the Plug and secure the aluminum-taped portion with the cable clamp.

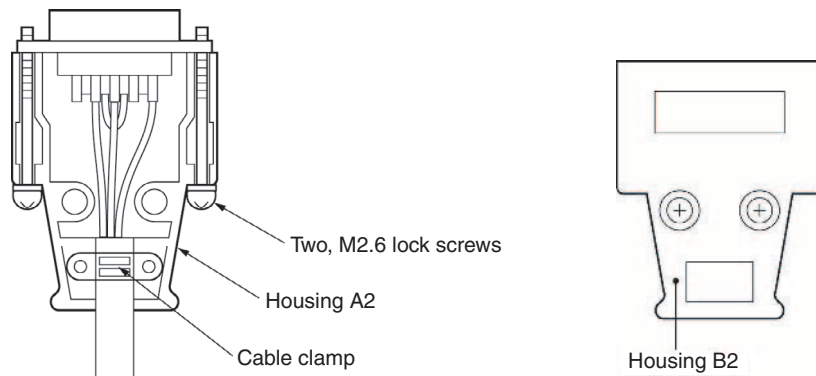

4. Secure the two connector fixing screws and put on housing B2 to complete the connector assembly.

• **Connection and Disconnection of Connector**

- When connecting the connector, be sure to hold the connector by hand and fully insert the connector. Then secure the connector by tightening the two lock screws.
- When disconnecting the connector, completely loosen the two lock screws. Then hold the protruding part of the connector hood by hand and pull the connector out straight. If the connector is difficult to disconnect, hold the Controller by hand while pulling out the connector.

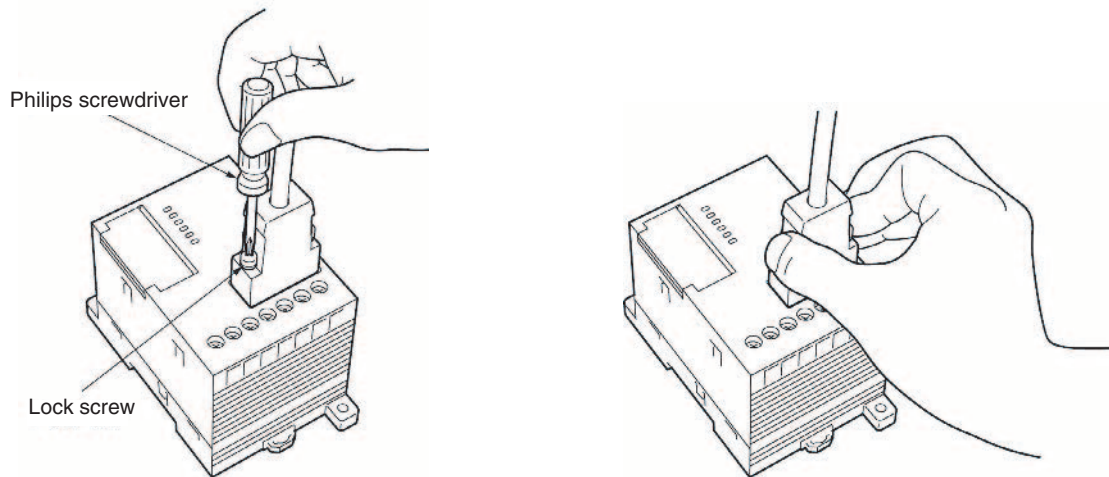

Example of Grounding the Shield Wire at the Controller

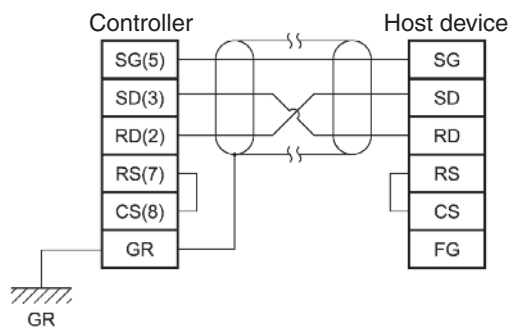

- The shielded wire must be grounded either from the Controller or the host device to prevent system malfunctions. The example shown here is of grounding from the Controller.
- Internally short-circuit the RS and CS pin in the connector.

RS-485 Interface Connection (V680-CA2D)



Pin No.	1	2	3	4
Polarity	+	-	+	-

* Pin numbers 1 and 3, and 2 and 4 are internally short-circuited in the connector.

• 1:N Connection

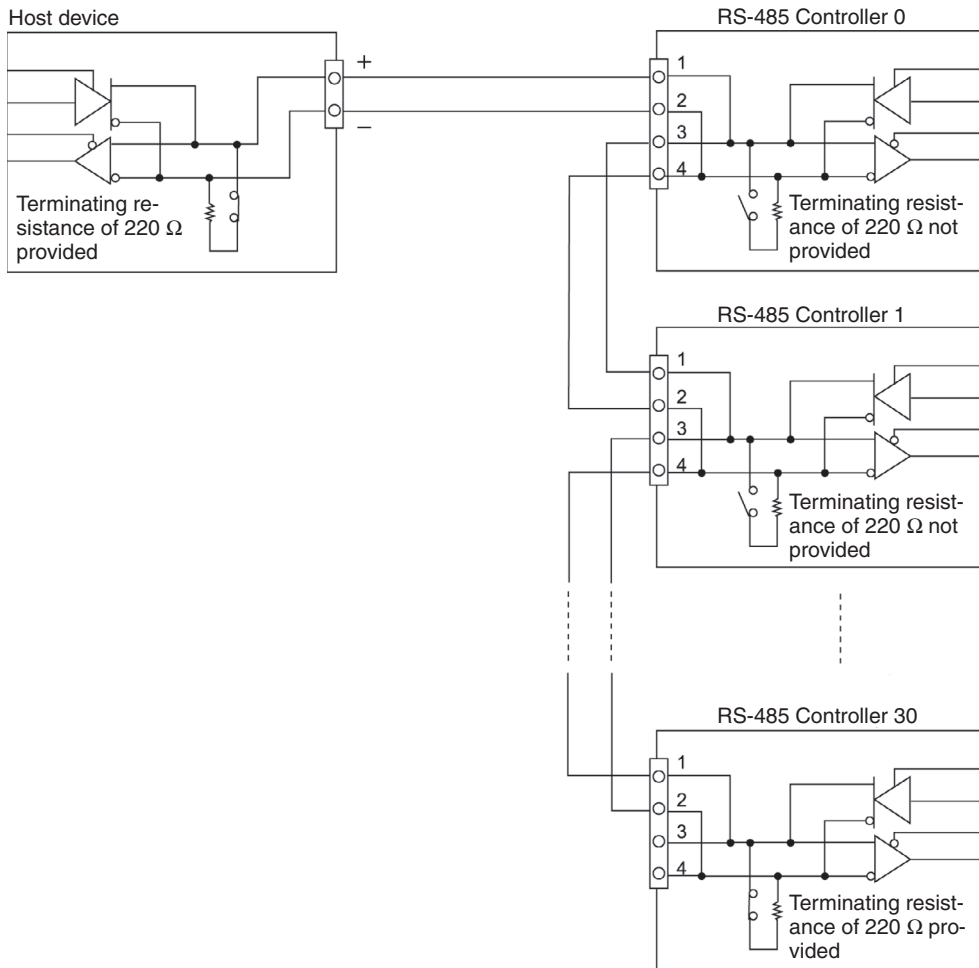

Correct Use

Send the following commands from the host device after confirming the response from the Controller. When using an RS-232C/485 Adapter at the host device, make sure that sending is completely enabled before sending the command. After the command is completely sent, change to receiving mode within 5 ms. Otherwise, communications with the Controller may not be possible.

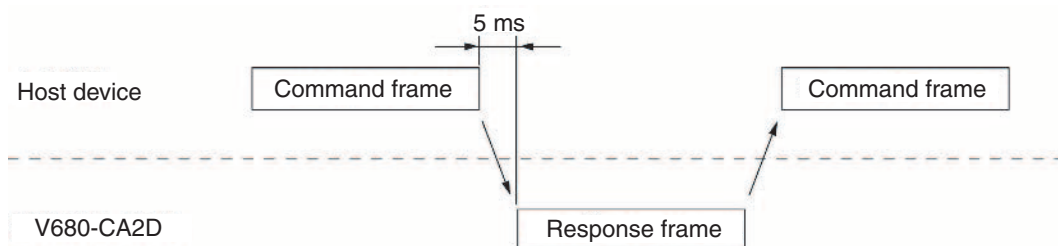

Wiring Example

Use an RS-485 Interface Cable with a shield, and connect the shield to the ground terminal.

- 1:N Connection

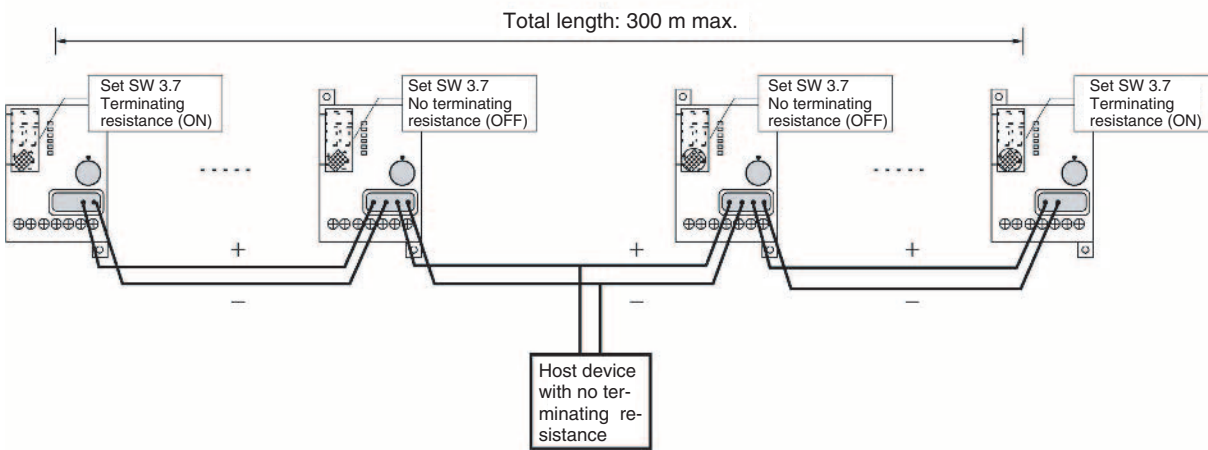
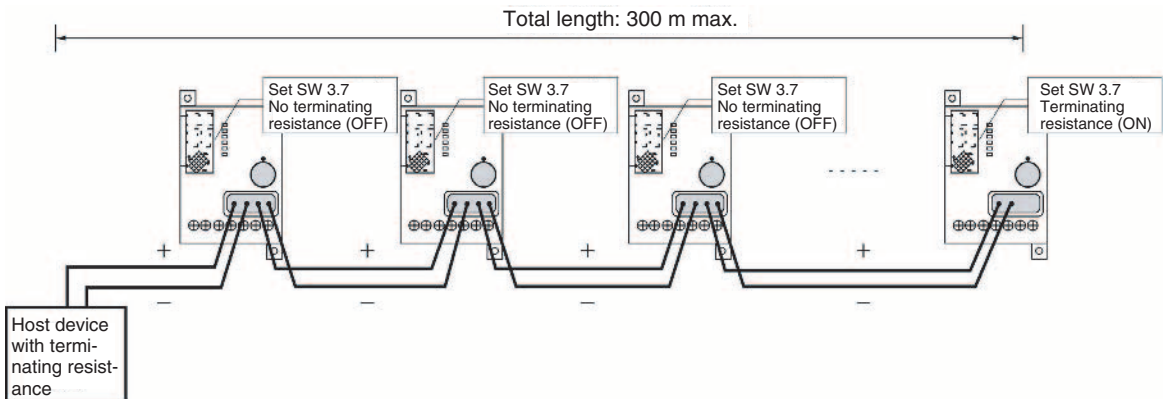

Note

If the recommended cables are not used, wire the RS-485 interface cable and synchronous cable in parallel. The environment-resistive noise characteristic may be reduced even when wired in parallel, however, if the following configurations shown in examples 2 and 3 are used.

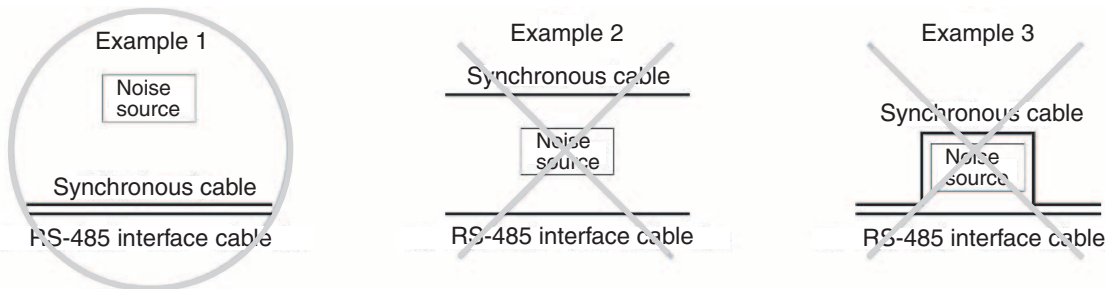

* Noise source: Other devices, power lines, AC Adapters, etc.

Connecting and Disconnecting the Connector

1. Attach the crimp terminals to the sections of the cable where the sheath has been stripped.
Make sure the connector is facing the right direction and insert each wire into the correct connector hole.

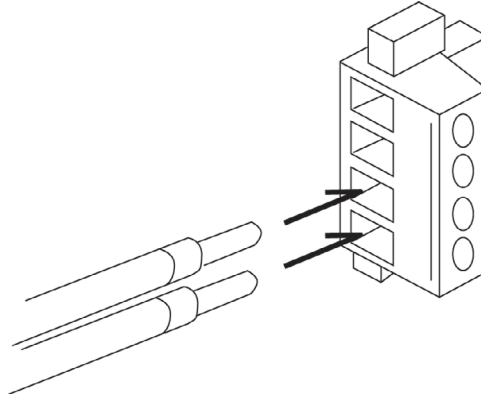

2. Securely tighten the connector's cable fixing screws for each wire.

Use a small flat-blade screwdriver with a uniform thickness. Do not use a standard screwdriver with a tapered end only. Otherwise, the screwdriver will not fully insert into the hole.

Tighten the cable fixing screws to a suitable torque of approximately 0.5 N·m.

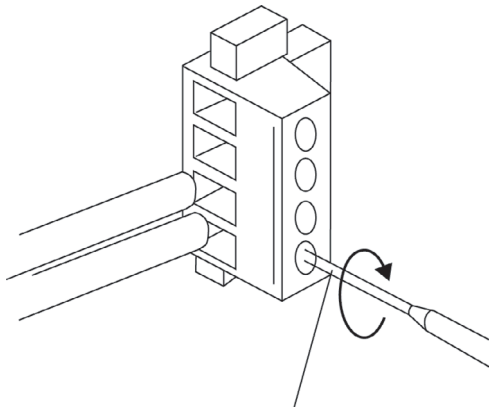

Small flat-blade screwdriver
with a tip of uniform thickness.

The following screwdriver is available.

OMRON: XW4Z-00C

End shape

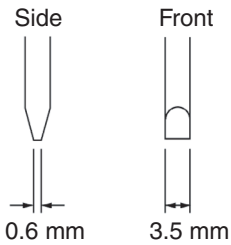

3. Connect the connector that is attached to the cable to the Controller.

Make sure that the connector on the Controller and the connector on the cable are facing the right direction, and push them together firmly. Tighten the fixing screws to a suitable torque of approximately 0.3 N·m.

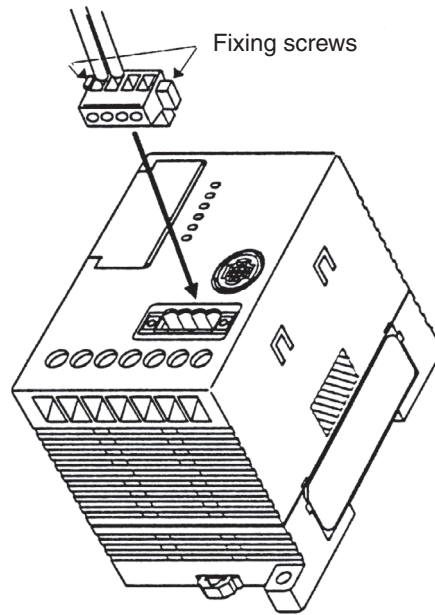

4. To disconnect connectors, completely unscrew the two fixing screws, hold the protruding part of the connector and pull the connector out straight. If the connector is difficult to disconnect, hold down the Controller and pull out the connector.



Do not connect the cable with the connector connected to the Controller.

Section 3

Before Communications

☒ Switch Settings	38
Opening the Cover	38
Setting Methods	39
Default Settings	39
Rotary Switch Settings	40
DIP Switch Settings	40
☒ Communications Test	42

Switch Settings

Open the cover of the Controller to make each of the switch settings.

Opening the Cover

A screwdriver is provided with the Controller. Open the cover by inserting the screwdriver into the groove on the left side of the cover.

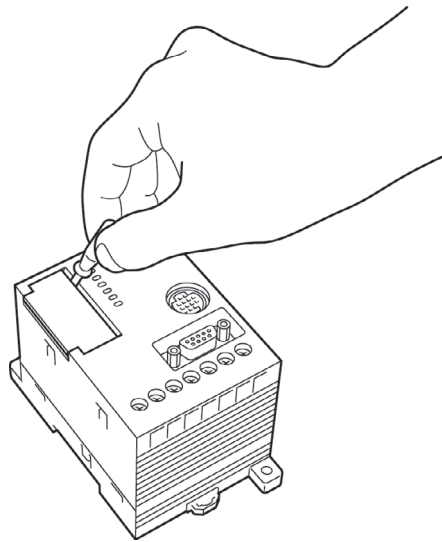

Under the cover, there are two rotary switches (SW1 and SW2) and two DIP switches (SW3 and SW4).

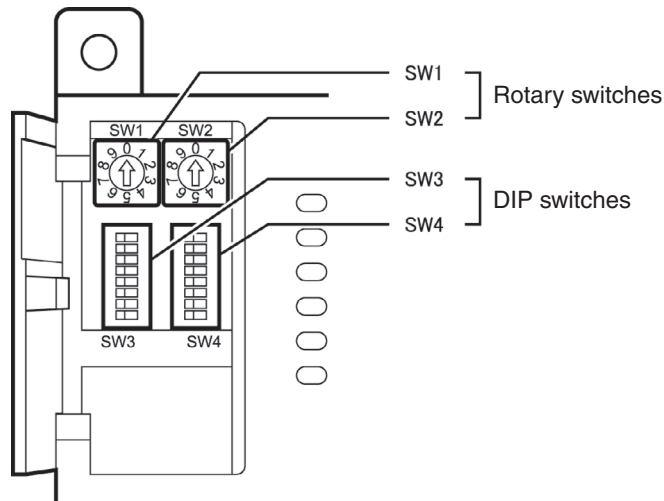

Setting Methods

Use the provided screwdriver to make switch settings as shown in the following diagram.

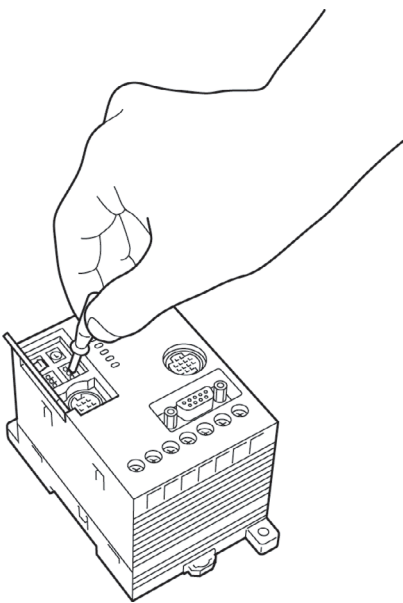
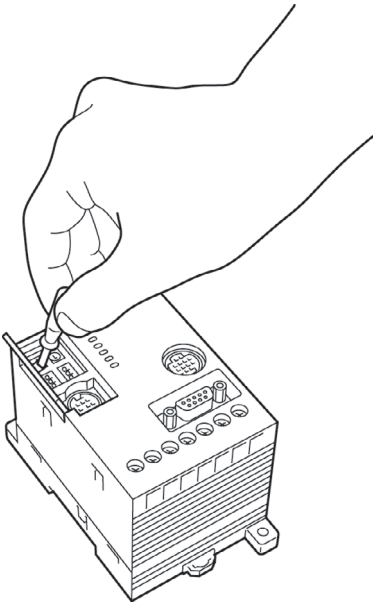

• Rotary switch settings

• DIP switch settings

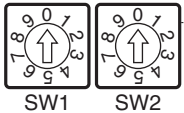
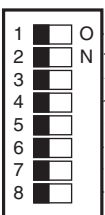

Default Settings

The following table shows the default settings (factory settings).

		Name	Default setting	Details	
 <p>SW1 SW2</p>	SW1	Node number	0	Node number 0	
	SW2	Reserved by the system.	0	Set to 0.	
 <p>SW3 (left)</p>	SW3-1	Reserved by the system.	OFF	Always OFF	
	SW3-2	Reserved by the system.	OFF	Always OFF	
	SW3-3	Reserved by the system.	OFF	Always OFF	
	SW3-4	Reserved by the system.	OFF	Always OFF	
	SW3-5	Reserved by the system.	OFF	Always OFF	
	SW3-6	Reserved by the system.	OFF	Always OFF	
	SW3-7	CD1D	Not used.	OFF	(Not used.)
		CD2D	RS-485 terminating resistance		No terminating resistance
 <p>SW3 (right)</p>	SW3-8	Reserved by the system.	OFF	Always OFF	
	SW4-1	Baud rate	SW4-1	OFF	38,400 bps
			SW4-2	OFF	
	SW4-3	Data length	OFF	7 (ASCII7)	
	SW4-4	Parity	SW4-4	OFF	Even
			SW4-5	OFF	
	SW4-6	Number of stop bits	OFF	2	
	SW4-7	Reserved by the system.	OFF	Always OFF	
SW4-8	Reserved by the system.	OFF	Always OFF		

Rotary Switch Settings

• Node Number Switch Setting (SW1)

If more than one Controller is connected to a single host device, the host device needs to be able to distinguish each of them. The ID number used for this purpose is called a node number. Each Controller must have a unique node number. Each command and response includes the node number of the Controller. Communications will not be possible if the node number is wrong. The node numbers must be correctly set regardless of whether the host device is connected to a single or multiple Controllers.

As shown in the following table, the node number switch can be set from 0 to 9.

SW1	Node No.
0	0
1	1
2	2
3	3
4	4
5	5
6	6
7	7
8	8
9	9

Setting Examples

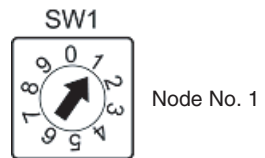
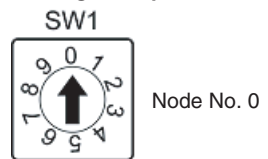

The node number switch is factory-set to 0.

• System Reserved Switch (SW2)

Do not use this switch. Always set this switch to 0.

DIP Switch Settings

• SW3

Pins 1 to 6 and pin 8: Reserved by the system

Do not use these pins. Always set these pins to OFF.

Pin 7: Not used (V680-CA1D)

Do not use this pin. Always set this pin to OFF.

Pin 7: RS-485 terminating resistance (V680-CA2D)

If two or more Controllers connected to the host device, terminating resistance of the Controllers at each end or the host device must be set to ON for stable communications.

Use this pin to set the built-in RS-485 terminating resistance to ON or OFF.

SW3, pin 7	Meaning
ON	RS-485 terminating resistance ON
OFF	RS-485 terminating resistance OFF



Be sure to set only the terminating resistance of the serially connected Controllers or host devices at each end to ON and that of any other device to OFF. Incorrect settings will result in unstable operations.

• SW4

Pins 1 and 2: Baud rate

SW4, pin 1	SW4, pin 2	Details
ON	ON	115,200 bps
	OFF	19,200 bps
OFF	ON	9,600 bps
	OFF	38,400 bps

Pin 3: Data length

SW4, pin 3	Details
ON	8 bits (JIS8) ON
OFF	7 bits (ASCII7) OFF

Pins 4 and 5: Parity

SW4, pin 4	SW4, pin 5	Details
ON	ON	None
	OFF	None
OFF	ON	Odd
	OFF	Even

Pin 6: Number of stop bits

SW4, pin 6	Details
ON	1
OFF	2

Pins 7 and 8: Reserved by the system

Do not use these pins. Always set these pins to OFF.

Communications Test

Check Items

Check the following items before the trial operation of the whole system.

No.	Items	Details	Page
1	Power supply and I/O line connections	<ul style="list-style-type: none"> • Are the power supply and I/O lines properly wired? • Are all the terminal screws tightened securely? 	p.25
2	DIP switch settings	<ul style="list-style-type: none"> • Is the node number set correctly? • Are the communications specifications set correctly? 	p.40 p.41
3	Antenna connection	Is the Antenna connected properly?	p.24
4	Host device connection	Is the RS-232C/RS-485 connector connected properly?	p.29 p.33
5	Antenna and Tag connection	Are the Antenna and Tag located properly?	p.98

Procedure for Trial Operation

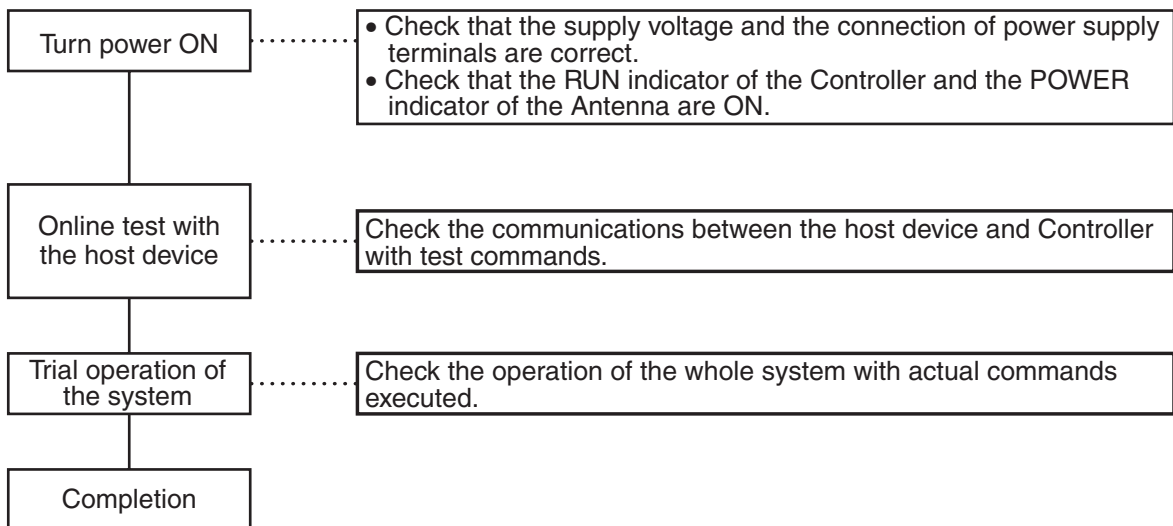

Communications Test with Host Device

Test commands are used to perform a communications test of the communications between the Controller and host device. This test enables the cable connections and processing operation of communications to be checked before the trial operation of the whole system.

1. Create a simple communications program on the host device and send the test commands.
If the communications line is normal, the Controller returns the data received.

• Example

Sending the message data “OMRON” from Controller No. 2.

Command				
Controller No.	Command code	Message data	FCS	Terminator
@ 0 2	T S	O M R O N	1 4	* CR
3	2	5	2	2

Response				
Controller No.	Command code	Message data	FCS	Terminator
@ 0 2	T S	O M R O N	1 4	* CR
3	2	5	2	2

Communication Test between the Tag and Read/Write Antenna

Actual commands are sent from the host device to test whether communication between the Tag and Read/Write Antenna is normal.

1. Connect the host device and Controller, and then turn ON the power to the Controller.
2. Send the AUTOWRITE command from the host device.
3. If communication with the Tag is normal, a response will be returned to the host device.

• Example

Using the Read/Write Antenna connected to Controller No. 2 to write the 2-byte data “1122” from Tag address 0010H (hexadecimal code).

Command							
Controller No.	Command code	Data designation	Antenna designation	Start address	Write data	FCS	Terminator
@ 0 2	A W	H 1	0 0 1 0	1 1 2 2	2 C	* CR	
3	2	1 1	4	4	2	2	

Response				
Controller No.	Command code	End code	FCS	Terminator
@ 0 2	A W	0 0	5 4	* CR
3	2	2	2	2

MEMO

Section 4

Reading from/Writing to Tags

☒ Tag Operation and Command Status	46
☒ Tag Memory Map	50
☒ Command and Response Format	56
☒ Communications Commands	62
☒ Communications Subcommands	72
☒ Controller Control Commands	73
☒ Other Commands	76

Tag Operation and Command Status

Communications Control Procedure

- (1) The first right to send is held by the host device, and is transferred to the Controller after a command is sent.
- (2) When a response is returned from the Controller, the right to send is transferred back to the host device.
- (3) The right to send is transferred by using a carriage return (CR).

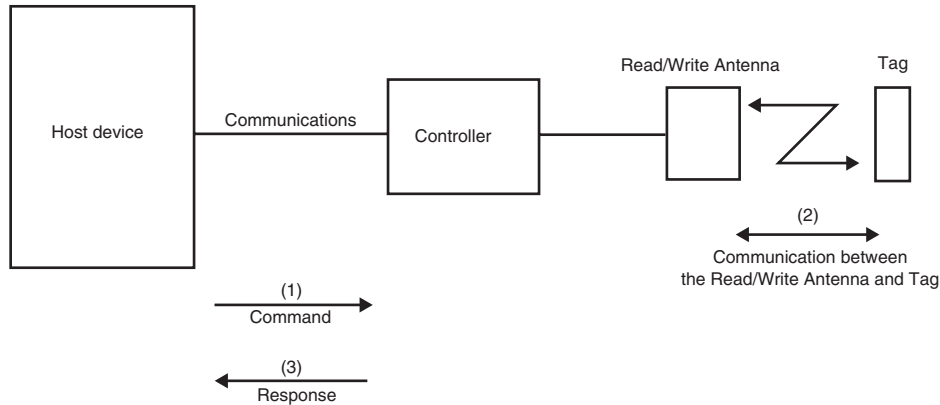

• Explanation

- (1) The host device sends a command to the Controller.
- (2) The Controller analyzes the command from the host device, transmits the command and writes data to or reads data from the memory in the Tag.
- (3) For read commands, the read data and response is sent to the host device. For write commands, a response indicating that processing is completed is sent to the host device.

Command Receiving Status

The status of the Controller for commands from the host device is as follows:

- **Command Standby Status**

No command processing is performed and Controller commands can be received.

- **Processing Command**

The time from when a READ, WRITE, AUTO READ, or AUTO WRITE command is received until a the response indicating that command processing is completed has been returned.

In this status, the COMMAND PROCESSING ABORT and ABORT commands only can be received.

- **Polling Auto Subcommand Standby Status**

The following processing is performed after receiving a POLLING AUTO command.

(1) Processing with the Data Carrier is ended, and the processing results are returned as the response when a polling processing request command is sent.

(2) The time until processing is aborted when a POLLING PROCESSING ABORT command is sent.

In this status, only the POLLING SUBCOMMAND (REQUEST, ABORT) or ABORT command can be received.

Read/Write Functions

• Read/Write Command Processing

The read/write functions are used for communications when the Tag has stopped. Therefore, check that the Tag is at a fixed position, which is within the Read/Write Antenna's communications area.

If a Tag is not present, a "no tag" error response is returned.

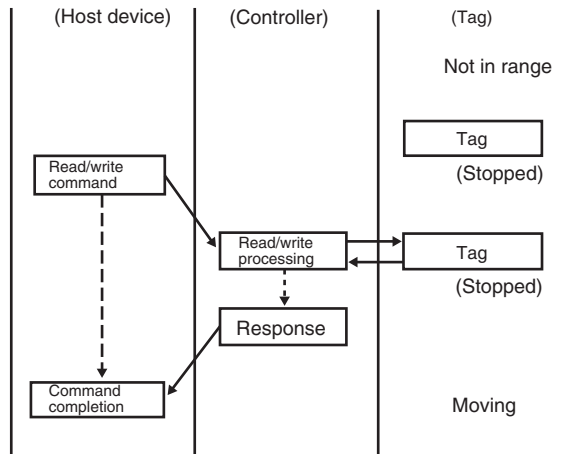

- (1) The Tag is checked for whether it has stopped at a specified location, and then the host device sends the command.
- (2) The Controller performs read or write processing according to the command.
- (3) After processing has been completed, the Controller returns a processing completed response to the host device. The host device receives the response and then moves the workpiece (with Tag) along the production line.

Auto Read/Write Functions

• Auto Command Processing

The Controller does not return a response for AUTO commands until the Tag is within range, i.e., the communications path with the host device is busy during this time.

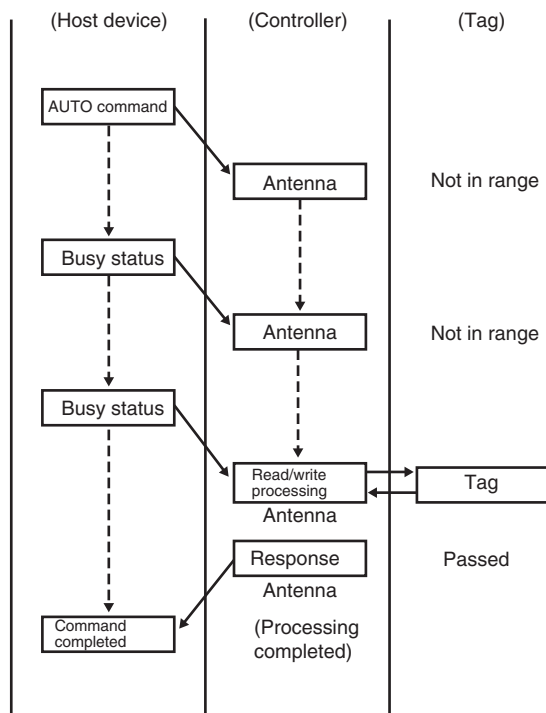

- (1) An AUTO command is sent to the Read/Write Antenna from the host device.
- (2) The Controller does not return a response while the Tag is not in range, so the host device is in busy status.
- (3) Read or write processing is performed when the Tag passes in front of the Antenna.
- (4) After processing has completed, the Controller sends a processing completed response for the AUTO command to the host device.

Polling Function

With normal AUTO commands, the Controller does not return a response while the Tag is not in range, i.e., the communications path with the host device is busy.

With a POLLING AUTO command, however, the Controller returns a response if a request is received from the host device. Therefore, the communications path does not continue to remain in busy status.

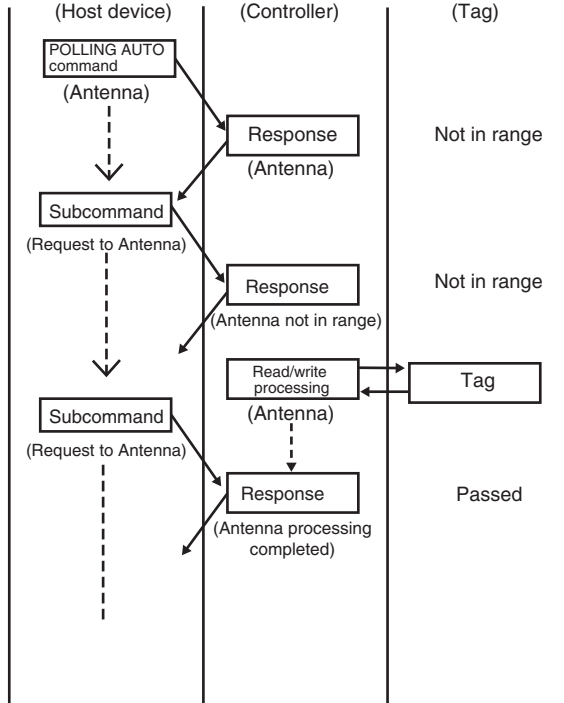

- (1) A POLLING AUTO command is sent to the Antenna.
- (2) After receiving the command, the Controller immediately returns a response indicating that the command was received.
- (3) The host device can send subcommands to request to proceed with processing, or abort polling auto processing.
- (4) If the Tag is not in range, an out-of-range response will be returned for the subcommand request.
- (5) Read or write processing is performed when the Tag passes in front of the Read/Write Antenna.
- (6) After processing is completed, the Controller returns a response with the processing results to the host device for the request subcommand.

Tag Memory Map

Tag Memory Map

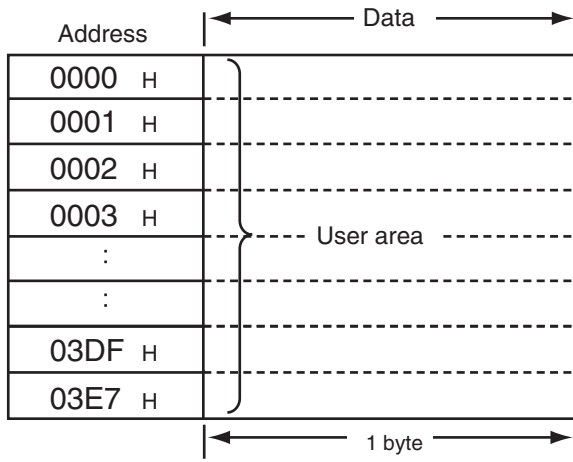

Tag Service Life Check

The OVERWRITE COUNT CONTROL command (MDS/MDL) determines whether the Tag overwrite count has been exceeded.

The overwrite count is subtracted from the data in the user-specified overwrite count control area to determine whether the number of overwrites have been exceeded. The MDL command can also be used to determine whether the overwrite count (100,000 times) has been exceeded. The overwrite count is added to the data in the user-specified overwrite count control area to determine whether the 100,000 overwrites have been exceeded.

Command



- Specifies the number of refreshes in hexadecimal. (00H, 01H, 02H, to FBH)
- Area start address setting range (□□□0H to □□□5H, or □□□8H to □□□DH)
- Read/Write Head channel setting (always 1)
- Mode setting
 - S: Overwrite control count subtraction method, user-specified (16,700,000 max.)
 - L: Overwrite count control addition method (100,000 fixed)

Response

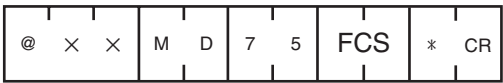

- End code
 - 75: Within specified overwrite count
 - 76: Specified overwrite count exceeded warning



Set the start address between □□□0H and □□□5H or between □□□8H and □□□DH. If the start address is set between □□□6H and □□□7H or between □□□EH and □□□FH, an address error (error code: 7A (hexadecimal)) will be returned in the end code.

CHECK!

• MDS Command

The overwrite count control area consists of 3 bytes from the start address. The decrement value from the overwrite count is written in this area, and if this value is 0 (00H), an end code 76 will be given as a warning. Therefore, to enable control of the number of overwrites, the maximum number of overwrites must be written to the overwrite count control area beforehand.

The user-specified number of overwrites can be set to up to 16,700,000. The number of overwrites in the specifications for Tags, however, is 100,000 overwrites (0186A0H), so be sure to set the number of overwrites to 100,000 or lower. The number of overwrites is controlled using hexadecimal values, and can be read using the READ command.

If the control area data is already 0, the control area value will not be refreshed, and only a warning will be returned as a response. When the refresh count is set as 00H, the count will not be updated, and only an overwrite count check will be performed.

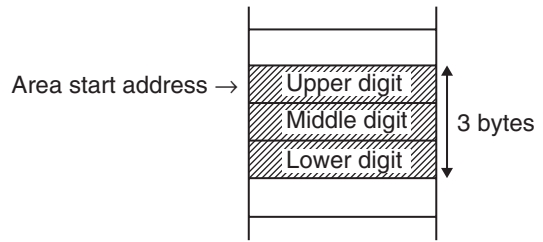

Example Using the OVERWRITE COUNT (MDS) Command

(1) The overwrite count of 100,000 times is written.

```
@xxWTH10010186A0[FCS]*CR
```

0010	0 4 H
0011	9 3 H
0012	E 0 H

(2) Enter the overwrite count of 5.

```
@xxMDS1001005[FCS]*CR
```

A total of 5 times will be decremented from 100,000.

0010	0 4 H
0011	9 3 H
0012	D B H

(3) The accumulated count is 100,000 times.

"MD76" (overwrite count exceeded)

0010	0 0 H
0011	0 0 H
0012	0 0 H

• MDL Command

The overwrite count control area consists of 3 bytes from the start address. The increment value from the overwrite count is written in this area, and if this value is 100,000 (0186A0H) or higher, an end code 76 will be given as a warning. The number of overwrites is controlled using hexadecimal values, and can be read using the READ command.

If the control area data is already 100,000 or higher, the control area value will not be refreshed, and only a warning will be returned as a response. When the refresh count is set as 00H, the count will not be updated, and only an overwrite count check will be performed.

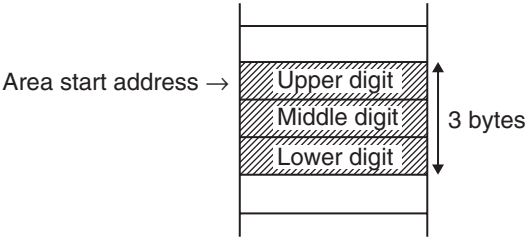

Example Using Overwrite Count Control Command (MDL)

In the following example, the three bytes from address 0010H is the overwrite count control area

(1) Clear the control area.

```
@\xWTH1001000000[FCS]*CR
```

0010	00 H
0011	00 H
0012	00 H

(2) Enter the overwrite count of 4.

```
@\xMDL1001004[FCS]*CR
```

0010	00 H
0011	00 H
0012	04 H

(3) Next, enter the overwrite count of 5.

```
@\xMDL1001005[FCS]*CR
```

The total overwrite count is 9 times.

0010	00 H
0011	00 H
0012	09 H

(4) The accumulated count is 100,000 times.

```
"@\xMD76[FCS]*CR"
```

(overwrite count exceeded.)

0010	04 H
0011	86 H
0012	AD H



Do not execute the MDS command and MDL command together for the same Tag. Doing so will prevent managing the service life.

Tag Memory Check Function

The DATA CHECK command (MD) performs a memory check. A CRC (Cyclic Redundancy Check) code calculation, write, and comparison are made using the check block units specified by the user. The CRC code is calculated from the generated polynomial expression $x^{16} + x^{12} + x^5 + 1$.

Command

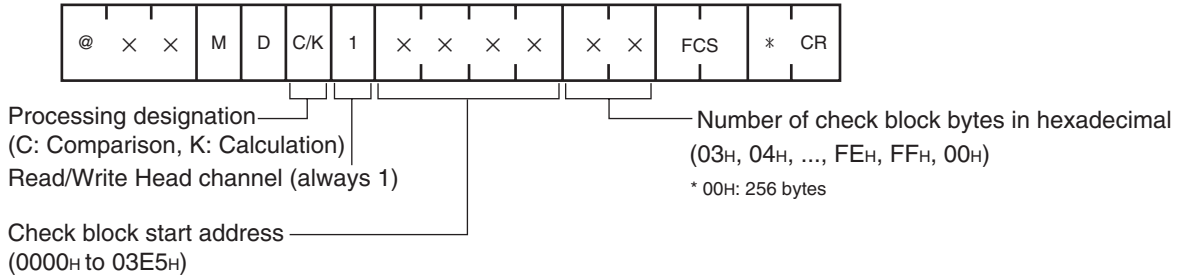

Response

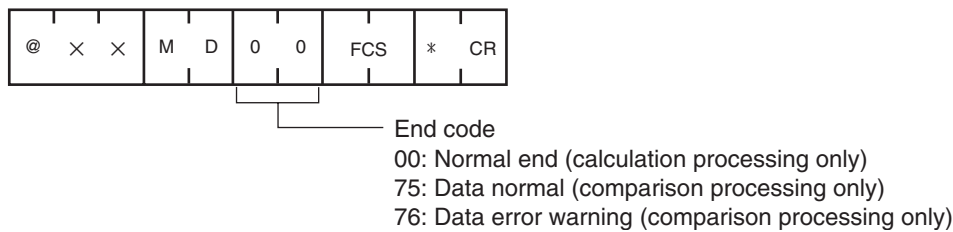

The calculation area is the portion of the check block specified by the start address and the number of bytes excluding the last two bytes. The last two bytes are the check code area.

When check code write is specified (transaction code: K), the CRC of the calculation area data is calculated and written to the check code area. When data comparison is specified (transaction code: C), the CRC of the calculation area data is calculated and a comparison made with the check code area data. If they coincide, end code 75 is returned, and if they do not coincide, end code 76 is returned as a warning.

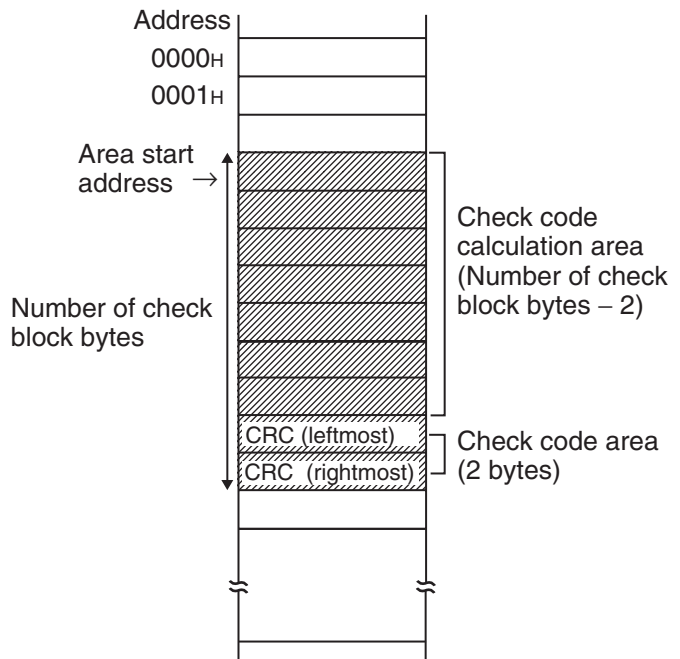

• Example Using Tag Memory Check Function

In the following example, the data in address 0010H to 0012H is checked.

(1) In this example, the following data already exists in the memory.

0010H	1 2 H
0011H	3 4 H
0012H	5 6 H
0013H	
0014H	

(2) Execute @xxMDK1001005 [FCS] (calculation transaction). The CRC code 5CD6H calculated from the data 123456 is written to addresses 0013H and 0014H.

0010H	1 2 H
0011H	3 4 H
0012H	5 6 H
0013H	5 C H
0014H	D 6 H

(3) Execute @xxMDC1001005 [FCS] (comparison transaction). The normal response @xxMD75[FCS] will be returned if the data coincides.

0010H	1 2 H
0011H	3 4 H
0012H	5 6 H
0013H	5 C H
0014H	D 6 H

If a data error occurs, @xxMD76[FCS] (a data error warning) will be returned.

0010H	0 0 H	← Data error
0011H	3 4 H	
0012H	5 6 H	
0013H	5 C H	
0014H	D 6 H	

Command and Response Format

The configuration of the command and response formats used for communications between the host device and Controller is described below.

Command and Response Frames

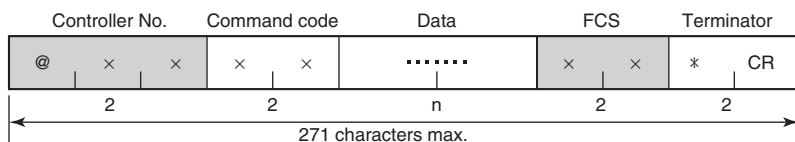

Name	Details
Controller No.	Specifies the unit number of the Controller to be used as the communications partner in decimal. Does not respond to any node other than the local node. Setting range: 00 to 09
Command code	A two-character symbol indicating the command function is entered. The same symbol used for the command is entered in the response. If a code is received that is not in the list of commands, an IC error is returned.
Data	Contains the read data or other data according to the execution details (command).
FCS	Horizontal parity check data is entered.
Terminator	Indicates the end of the command using the two characters: * (\$2A) and CR code (\$0D).

Data Code Designation

Data to be read or written is specified in the command to be handled as either ASCII (JIS8 unit code) character data or as hexadecimal numerical data.

- ASCII (JIS8 Unit Code) Designation

Each data character is allocated 1 byte (1 address) of Tag memory and stored as ASCII or JIS8 unit code.

Tag memory address			
0010 _H	4	F	"O"
0011 _H	4	D	"M"
0012 _H	5	2	"R"
0013 _H	4	F	"O"
0014 _H	4	E	"N"

ASCII Designation Example

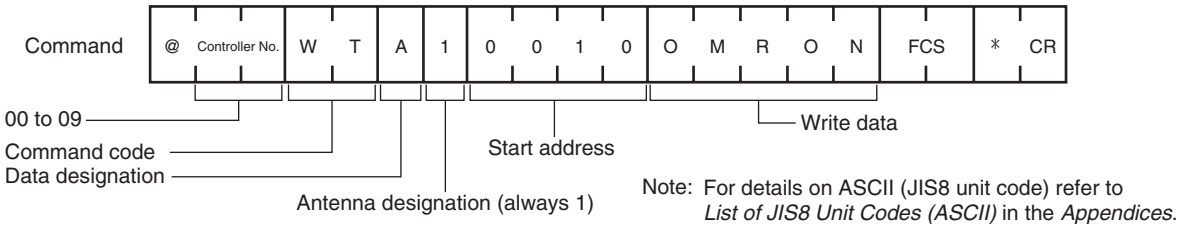

- Hexadecimal Code Designation

Characters are handled as hexadecimal data. Therefore, only characters 0 to F can be received. Each two characters of data is stored as is in 1 byte (1 address) of Tag memory. Therefore, always set two-character units (even number of characters) for write commands.

Tag memory address		
0020 _H	1	9
0021 _H	8	8
	← 1 byte →	

One byte of Tag data is converted to two hexadecimal characters (00 to FF) and transmitted. A command error will occur if an odd number of characters is mistakenly set.

Hexadecimal Code Designation Example



List of Command Codes

Commands can be classified into four major types.

- **Communications Commands**

The following commands are used for communications with the Tag.

Command code	Name	Function	Page
RD	READ	Reads memory data from the Tag.	p.62
WT	WRITE	Writes data to the memory of the Tag.	p.63
AR	AUTO READ	Reads data from the Tag when the Tag is within the communications area. Processing is aborted with the AUTO COMMAND PROCESSING ABORT command (AA) command standby status is resumed.	p.64
AW	AUTO WRITE	Writes data to the memory of the Tag when the Tag is within the communications area. Processing is aborted with the AUTO COMMAND PROCESSING ABORT command (AA) command standby status is resumed.	p.65
PR PRC/E	POLLING AUTO READ	Reads data from the Tag when the Tag is within the communications area. The command processing results can be requested using a subcommand.	p.66
PW PWC/E	POLLING AUTO WRITE	Writes data to the memory of the Tag when the Tag is within the communications area. The command processing results can be requested using a subcommand.	p.68
MD C/K	DATA CHECK	Performs a data check on the Tag memory.	p.70
MDS MDL	OVERWRITE COUNT CONTROL	Controls the heat cycle for the Tag.	p.71

- **Communications Subcommands**

These commands are used to cancel command execution when using the POLLING AUTO commands.

Command code	Name	Function	Page
AA	AUTO COMMAND PROCESSING ABORT	Aborts processing except for the polling command.	p.72

- **Controller Control Commands**

The Controller control command is used for interrupting communications with Tags or resetting the Controller.

Command code	Name	Function	Page
CC	CONTROLLER CONTROL	Performs user input operations.	p.73
XZ	ABORT (RESET)	The Controller is reset immediately after the power is turned ON. There is no response.	p.75

- **Host Commands**

Host commands test communications between the Controller and the host device.

Command code	Name	Function	Page
TS	TEST	Returns test data sent from the host device as is.	p.74

List of End Codes

The following table provides a list of the response end codes and their meanings.

Type	End code	Name	Details
Normal end	"00"	Normal end	The command execution was completed normally.
	"74" *1, 2	Polling command received	<ul style="list-style-type: none"> • A POLLING AUTO command has been received normally. • A polling request was received before communications with the Tag ended.
	"75"	Data normal	Data was normal when the DATA CHECK (MD) command was executed.
		Polling process canceled	Polling processing was canceled before communications with the Tag started.
		Auto processing canceled	Auto processing was canceled before communications with the Tag started.
	"76"	Data error	Data was not normal when a DATA CHECK (MD) command was executed.
		Polling process canceled	Polling processing was canceled after communications with the Tag started.
Auto processing canceled		Auto processing was canceled after communications with the Tag started.	
Host communications error	"10"	Parity error	A parity error occurred for one of the characters in the command.
	"11"	Framing error	A framing error (stop bits undetected) occurred in the received frame.
	"12"	Overrun error	An overrun error occurred for one of the characters in the command.
	"13"	FCS error	A received command had an incorrect FCS.
	"14"	Format error	<ul style="list-style-type: none"> • The command format is not suitable. • A communications command was received during communications. • An ABORT command was received when AUTO processing was not being performed. • A POLLING PROCESSING ABORT (P□E) command was received when polling was not being performed.
	"18"	Frame length error	A command exceeding the maximum frame length was received. After receiving the @ symbol, the number of characters exceeded 270 and no CR was received.
Tag communications error	"70"	Communications error	An error occurred in communications with the Tag and communications could not end normally.
	"71"	Mismatch error	Data cannot be written to the Tag correctly (verification enabled only). An error occurred during a verification check.
	"72"	No Tag error	Tag could not be detected during command execution.
	"7A"	Address designation error	The designated processing address is not suitable, and the execution is not possible.
	"7C"	Antenna error	<ul style="list-style-type: none"> • The Antenna is faulty. • The Antenna is not connected properly.

*1 When a POLLING AUTO command is sent, the Tag immediately returns a response (74) indicating that the command has been received.

*2 If a POLLING AUTO subcommand is sent to request the processing result when the Tag is not near the Head, the Read/Write Head returns a response (74) indicating that the Tag has not approached.

FCS Calculation Example

FCS (Frame Check Sequence) refers to 8-bit data with an exclusive OR (XOR) executed from the start of the frame (@ symbol) until the final character, converted into 2-bit ASCII.

- Reading 5 Bytes from Address 0010H

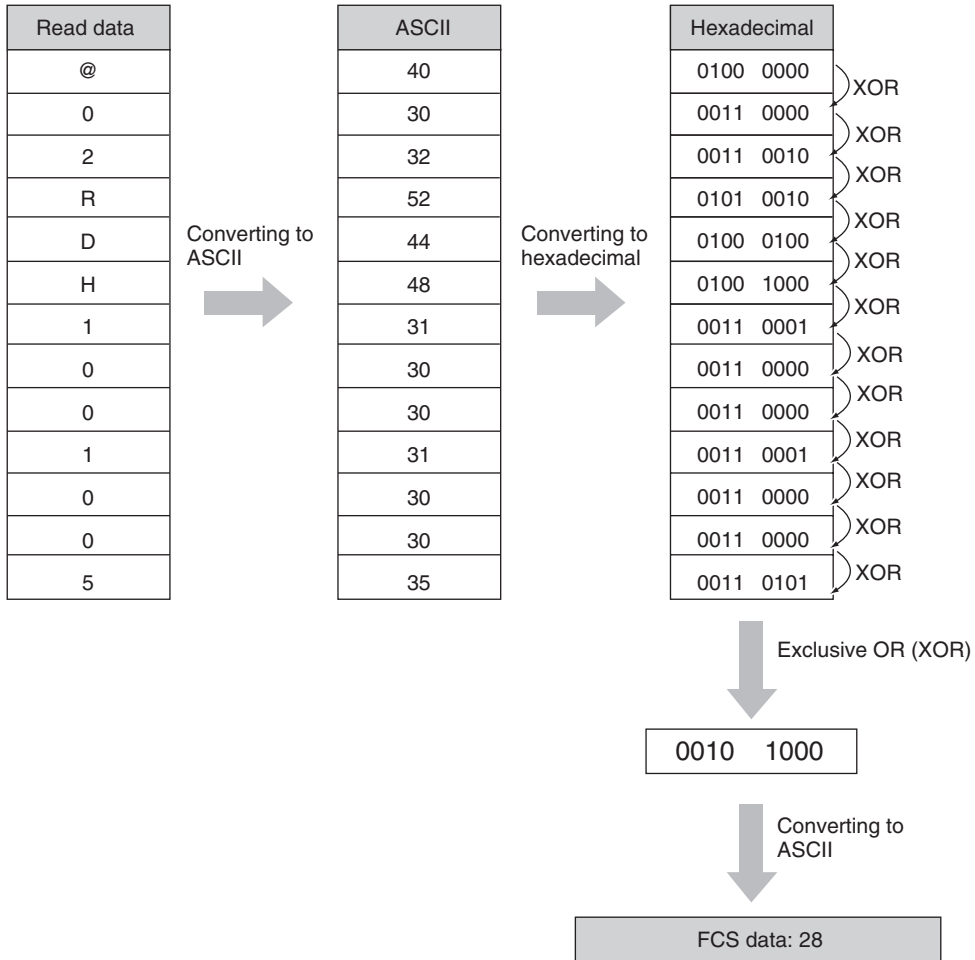
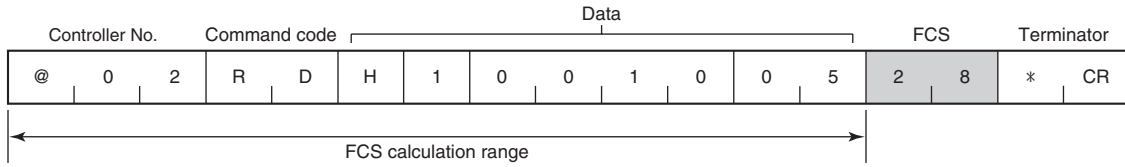

Numeric Range for Address Bytes

• Read Commands

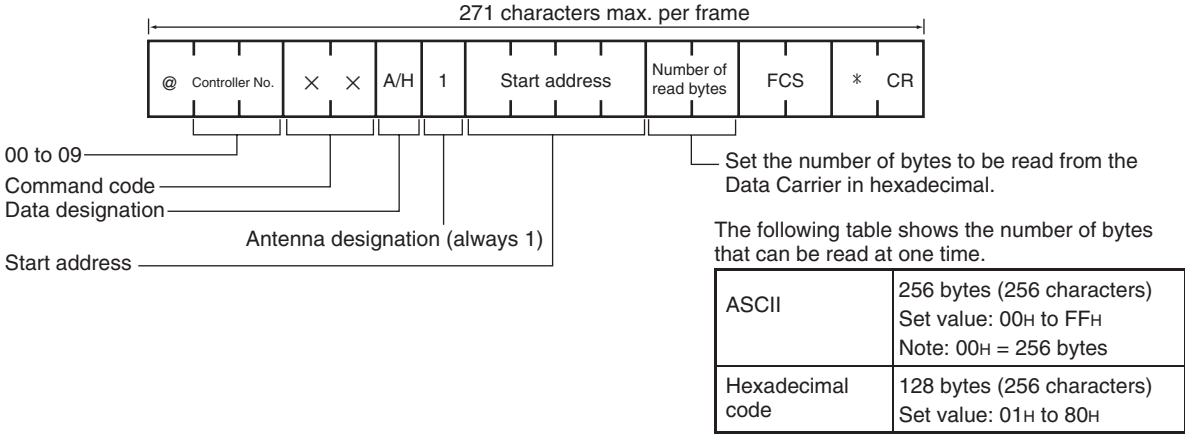

• Write Commands

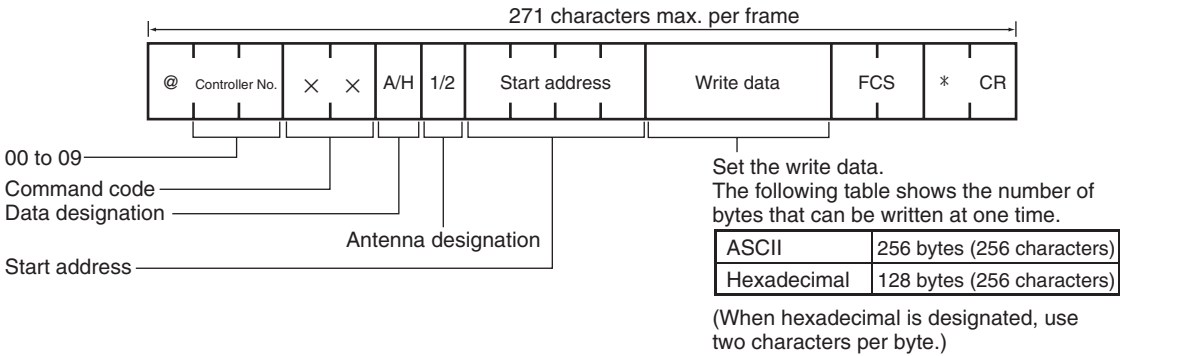

* When using multiple frames, make sure that each frame has 266 characters max.

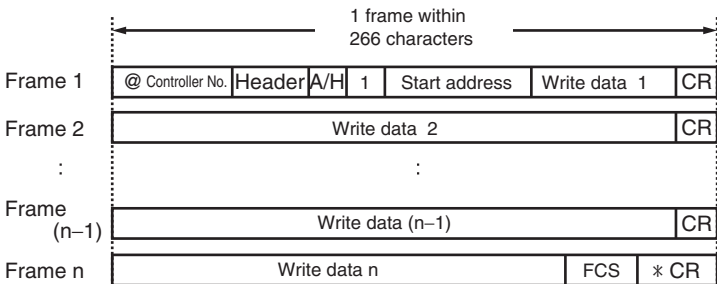

Communications Commands

READ (RD)

This command reads data from the Tag. If a Tag is not present, an error response (end code 72) is returned.

Command

Controller No.	Command code	Data type	Antenna designation	Start address	Number of read bytes	FCS	Terminator
@ × ×	R D	A/H	1	× × × ×	× ×	× ×	* CR
3	2	1	1	4	2	2	2

Name	Details
Data type	Specifies the code format when sending the read data response. A: ASCII H: Hexadecimal code
Antenna designation	Always 1
Start address	Specifies the start address of the area in the Tag from which data is to be read from in 4-digit hexadecimal code. The start address Setting range: 0000h to 03E7h
Number of read bytes	Specifies the number of bytes to be read from the Tag in 2-digit hexadecimal code. The number of bytes that can be read at one time is as follows: Setting range ASCII: 256 bytes (256 characters), set value: 01h to FFh Hexadecimal: 128 bytes (256 characters), set value: 01h to 80h

Response

Controller No.	Command code	End code	Read data	FCS	Terminator
@ × ×	R D	0 0	× ×	* CR
3	2	2	n	2	2

Name	Details
End code	Indicates the execution result for the command.
Read data	Contains the data read from the Tag. The number of characters is the number of read bytes for ASCII, and the number of read bytes × 2 for hexadecimal code.

• Example

Reading two bytes of data (hexadecimal code) from address 0010h of Controller No. 2.

Command

Controller No.	Command code	Data type	Antenna designation	Start address	Number of read bytes	FCS	Terminator
@ 0 2	R D	H	1	0 0 1 0	0 2	2 E	* CR
3	2	1	1	4	2	2	2

Response

Controller No.	Command code	End code	Read data	FCS	Terminator
@ 0 2	R D	0 0	1 1 2 2	5 4	* CR
3	2	2		2	2

WRITE (WT)

This command writes data to the Tag. If the Tag is not present, an error response (end code 72) will be returned.

Command

Controller No.	Command code	Data type	Antenna designation	Start address	Write data	FCS	Terminator
@ × ×	W T	A/H	1	× × × ×	× × × ×	× ×	* CR
3	2	1	1	4	n	2	2

Name	Details
Data type	Specifies the code format for sending the write data to the Tag. A: ASCII H: Hexadecimal code
Antenna designation	Always 1
Start address	Specifies the start address of the area to which data is to be written in 4-digit hexadecimal code. Setting range: 0000h to 03E7h
Write data	Contains the data to be written to the Tag. The number of bytes that can be written at one time is as follows: Setting range ASCII: 256 bytes (256 characters) Hexadecimal code: 128 bytes (256 characters) * When hexadecimal code is designated, specify two characters for each byte.

Response

Controller No.	Command code	End code	FCS	Terminator
@ × ×	W T	0 0	× ×	* CR
3	2	2	2	2

Name	Details
End code	Indicates the execution result for the command.

• Example

Writing two bytes of data "1122" (hexadecimal code) from address 0010h using Controller No. 2.

Command

Controller No.	Command code	Data type	Antenna designation	Start address	Write data	FCS	Terminator
@ 0 2	W T	H	1	0 0 1 0	1 1 2 2	3 9	* CR
3	2	1	1	4		2	2

Response

Controller No.	Command code	End code	FCS	Terminator
@ 0 2	W T	0 0	4 1	* CR
3	2	2	2	2

AUTO READ (AR)

This command reads data from the Tag when the Tag enters the communications area. The Controller returns a response when communications between the Controller and Tag has been completed. The host device cannot send other commands until either a response is received or processing is aborted using the COMMAND PROCESSING ABORT (AA) command.

Command

Controller No.	Command code	Data type	Antenna designation	Start address	Number of read bytes	FCS	Terminator
@ × ×	A R	A/H	1	× × × ×	× ×	× ×	* CR
3	2	1	1	4	2	2	2

Name	Details
Data type	Specifies the code format when sending the read data response. A: ASCII H: Hexadecimal code
Antenna designation	Always 1
Start address	Specifies the start address of the area in the Tag from which data is to be read from in 4-digit hexadecimal code. Setting range: 0000h to 03E7h
Number of read bytes	Specifies the number of bytes to be read from the Tag in 2-digit hexadecimal code. The number of bytes that can be read at one time is as follows: Setting range ASCII: 256 bytes (256 characters), set value: 01h to FFh Hexadecimal code: 128 bytes (256 characters), set value: 01h to 80h

Response

Controller No.	Command code	End code	Read data	FCS	Terminator
@ × ×	A R	0 0	× ×	* CR
3	2	2	n	2	2

Name	Details
End code	Indicates the execution result for the command.
Read data	Contains the data read from the Tag. The number of characters is the number of read bytes for ASCII, and the number of read bytes × 2 for hexadecimal code.

• Example

Reading two bytes of data (hexadecimal code) from address 0010h in the Tag in the communications area to Controller No.2.

Command

Controller No.	Command code	Data type	Antenna designation	Start address	Number of read bytes	FCS	Terminator
@ 0 2	A R	H	1	0 0 1 0	0 2	A 6	* CR
3	2	1	1	4	2	2	2

Response

Controller No.	Command code	End code	Read data	FCS	Terminator
@ 0 2	A R	0 0	1 1 2 2	5 1	* CR
3	2	2		2	2

AUTO WRITE (AW)

This command writes data to the Tag when the Tag enters the communications area. The Controller returns a response when communications between the Controller and Tag has been completed. The host device cannot send other commands until either a response is received or processing is aborted using the COMMAND PROCESSING ABORT (AA) command.

Command

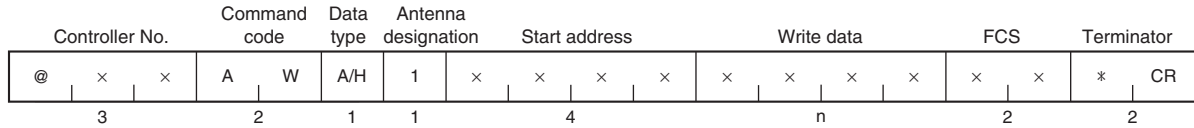

Name	Details
Data type	Specifies the code format for sending the write data to the Tag. A: ASCII H: Hexadecimal code
Antenna designation	Always 1
Start address	Specifies the start address of the area to which data is to be written in 4-digit hexadecimal code. Setting range: 0000h to 03E7h
Write data	Contains the data to be written to the Tag. The number of bytes that can be written at one time is as follows: Setting range ASCII: 256 bytes (256 characters) Hexadecimal code: 128 bytes (256 characters) * When hexadecimal code is designated, specify two characters for each byte.

Response

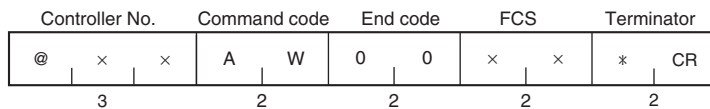

Name	Details
End code	Indicates the execution result for the command.

• Example

Writing two bytes of data “1122” (hexadecimal code) from address 0010h of the Tag in the communications area to Controller No. 2.

Command

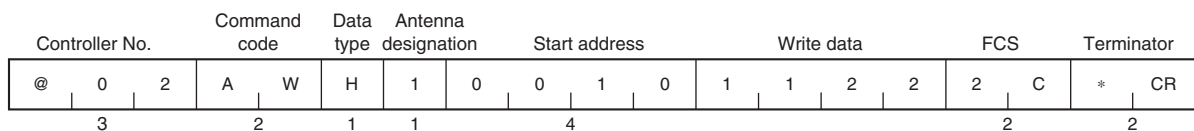

Response

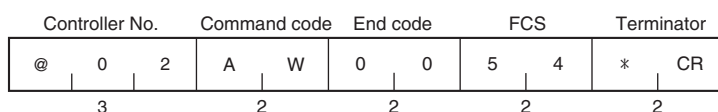

POLLING AUTO READ (PR)

When the host device sends a POLLING AUTO READ command to the Controller, the Controller immediately returns a response to the host device indicating reception of the command. Then the Controller waits for the approaching Tag and reads the data of the Tag when the ID Tag is in the communications area.

When the Tag is in the communications area, the host device can use a subcommand to request the command processing results.

Command

Controller No.	Command code	Data type	Antenna designation	Start address	Number of read bytes	FCS	Terminator
@ 3	P R 2	A/H 1	1 1	× × × × 4	× × 2	× × 2	* CR 2

Name	Details
Data type	Specifies the code format when sending the read data response. A: ASCII H: Hexadecimal code
Antenna designation	Always 1
Start address	Specifies the start address of the area in the Tag from which data is to be read from in 4-digit hexadecimal code. Setting range: 0000h to 03E7h
Number of read bytes	Specifies the number of bytes to be read from the Tag in 2-digit hexadecimal code. The number of bytes that can be read at one time is as follows: Setting range ASCII: 256 bytes (256 characters), set value: 01h to FFh Hexadecimal code: 128 bytes (256 characters), set value: 01h to 80h

Response

Controller No.	Command code	End code	FCS	Terminator
@ 3	P R 2	7 4 2	× × 2	* CR 2

Name	Details
End code	Indicates the execution result for the command.

Subcommand

Controller No.	Command code	Data type	Antenna designation	FCS	Terminator
@ 3	P R 2	C/E 1	1 1	× × 2	* CR 2

Name	Details
Data type	Specifies either to request the result of or to abort polling auto processing. Specifies the code format when sending the read data response. C: Request for processing results H: Abort
Antenna designation	Always 1

Subcommand Response

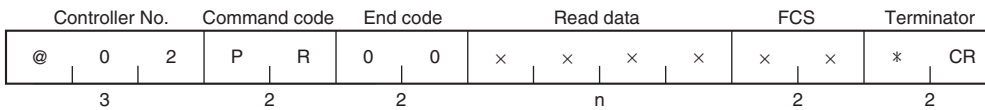

Name	Details
End code	Indicates the execution result for the command. 00: Normal completion. 74: The Tag was not in the communications area when the request for polling auto processing results was made. 75: The Tag was not in the communications area when polling auto processing was aborted. 76: Data processing with the Tag was in progress or had completed when the polling auto processing was aborted.
Read data	Indicates the data that was read according to the execution details (command).

• Example

Reading two bytes of data from address 0010h in the Tag in the communications area to Controller No. 2., and returning a response (hexadecimal code) for the polling processing results request.

Command

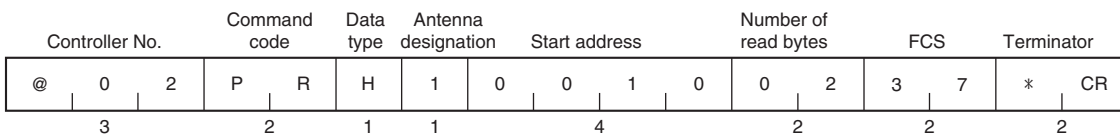

Response

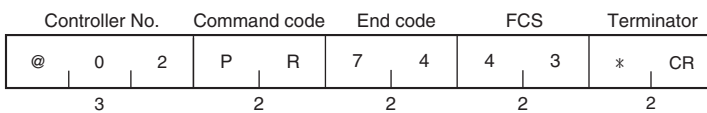

Subcommand

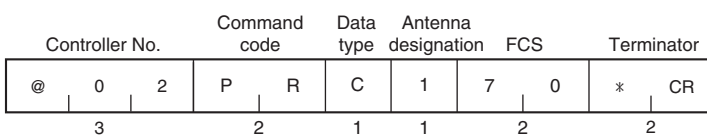

Subcommand Response

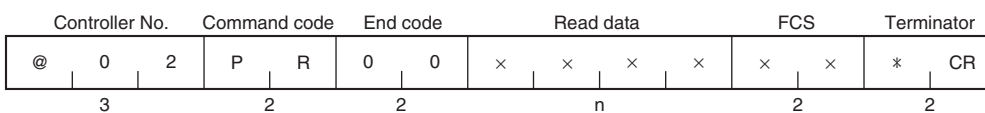

POLLING AUTO WRITE (PW)

When the host device sends a POLLING AUTO WRITE command to the Controller, the Controller immediately returns a response to the host device indicating reception of the command. Then the Controller waits for the approaching Tag and writes the data when the Tag is in the communications area.

When the Tag is in the communications area, the host device can use a subcommand to request the command processing results. The host device can also send a command to another Read/Write Head.

Command

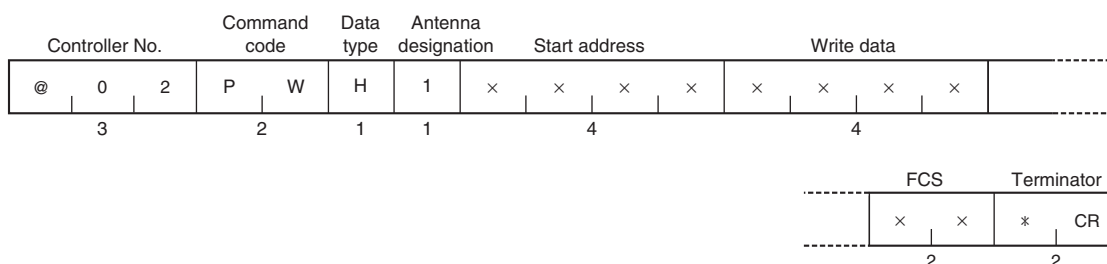

Name	Details
Data designation	Specifies the code format to be used when transmitting the response for the read data. A: ASCII H: Hexadecimal code
Antenna designation	Always 1
Start address	Specifies the start address of the area from which data is to be read from the Tag in 4-digit hexadecimal. Setting range: 0000h to 03E7h
Number of write bytes	Specifies the number of data bytes to be written to the Tag in 4-digit hexadecimal. Setting range: 0000h, or 0001h to 0080h * When 0000h is specified, the data will be written to the user area from the specified start address until the Tag's final address.

Response

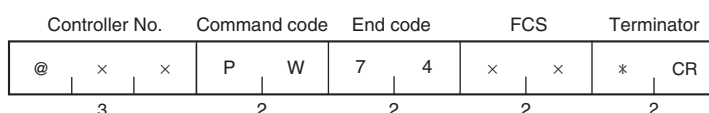

Name	Details
End code	Indicates the execution result for the command.

Subcommand

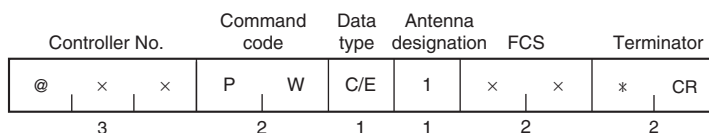

Name	Details
Data designation	Specifies either to request the result of or to abort polling auto processing. Specifies the code format when sending the read data response. C: Processing result request H: Aborted
Antenna designation	Always 1

Subcommand Response

Controller No.	Command code	End code	FCS	Terminator
@ × ×	P W	0 0	× ×	* CR
3	2	2	2	2

Name	Details
End code	Indicates the execution result for the command. The end code 00 indicates normal completion. 74: Tag was not in range when polling auto processing results were requested 75: Tag was not in range when polling auto processing was aborted. 76: Tag was communicating or processing had completed when polling auto processing was aborted.
Read data	Displays the read data according to the execution details (command).

• Example

Writing two bytes of data “1122” from address 0010h of the Tag in the communications area to Controller No. 2., and returning a response (hexadecimal code) for the polling processing results request.

Command

Controller No.	Command code	Data type	Antenna designation	Start address	Write data
@ 0 2	P W	H	1	0 0 1 0	1 1 2 2
3	2	1	1	4	4

FCS	Terminator
3 0	* CR
2	2

Response

Controller No.	Command code	End code	FCS	Terminator
@ 0 2	P W	7 4	4 6	* CR
3	2	2	2	2

Subcommand

Controller No.	Command code	Data type	Antenna designation	FCS	Terminator
@ 0 2	P W	C	1	3 7	* CR
3	2	1	1	2	2

Subcommand Response

Controller No.	Command code	End code	FCS	Terminator
@ 0 2	P W	0 0	4 5	* CR
3	2	2	2	2

DATA CHECK (MD C/K)

This command writes or compares the CRC code for the specified check block in byte units. The CRC code is calculated from the generated polynomial expression $X^{16} + X^{12} + X^5 + 1$.

Command

Controller No.	Command code		Process setting	Channel designation	Start address				Number of check block bytes		FCS		Terminator		
@	x	x	M	D	C/K	1	1	x	x	x	x	x	x	*	CR
3	2	1	1	4	2	2	2	2	2	2	2	2	2	2	2

Name	Details
Process setting	Specifies the check process. C: Check code comparison K: Check code calculation
Channel designation	Always 1
Start address	Specifies the start address of the check block in 4-digit hexadecimal. Setting range: 0000h to 03E5h
Number of check block bytes	Specifies the number of bytes for the check block in 2-digit hexadecimal. Setting range: 03h to FFh, 00h (00: 256 bytes)

Response

Controller No.	Command code		End code		FCS		Terminator			
@	x	x	M	D	0	0	x	x	*	CR
3	2	2	2	2	2	2	2	2	2	2

Name	Details
End code	Indicates the execution result for the command. The end code 00 indicates normal completion. (calculation processing only) 75: Data normal (comparison processing only) 76: Data error warning (comparison processing only)

• Example

Adding the check code to 4-byte data from Controller No. 2 address 0010h.

Command

Controller No.	Command code		Data type	Antenna designation	Start address				Number of check block bytes		FCS		Terminator				
@	0	2	M	D	K	1	1	0	0	1	0	0	6	3	6	*	CR
3	2	1	1	4	2	2	2	2	2	2	2	2	2	2	2	2	2

Response

Controller No.	Command code		End code		FCS		Terminator			
@	0	2	M	D	0	0	4	B	*	CR
3	2	2	2	2	2	2	2	2	2	2

OVERWRITE COUNT CONTROL (MDS/MDL)

This command is used to control the number of overwrite operations performed by Tags. Whether the EEPROM overwrite count has been exceeded or not is determined by refreshing the user-specified overwrite count control area.

Command

Controller No.			Command code		Mode setting	Channel designation	Start address				Number of refreshes		FCS		Terminator	
@	x	x	M	D	S/L	1	x	x	x	x	x	x	x	x	*	CR
3			2		1	1	4				2		2		2	

Name	Details
Mode setting	Specifies the mode for the overwrite count. S: User-specified overwrite count using subtraction method (16,700,000 max.) L: Fixed overwrite count of 100,000 using addition method
Channel designation	Always 1
Start address	Specifies the start address of the overwrite count control area in 4-digit hexadecimal. Setting range: 0000h to 03E5h
Number of refreshes	Specifies the number of refreshes in 2-digit hexadecimal. Setting range: 00h to FFh (00: Checks number of refreshes only)



Set the start address between $\square\square\square0\text{H}$ and $\square\square\square5\text{H}$ or between $\square\square\square8\text{H}$ and $\square\square\square\text{DH}$. If the start address is set between $\square\square\square6\text{H}$ and $\square\square\square7\text{H}$ or between $\square\square\square\text{EH}$ and $\square\square\square\text{FH}$, an address error (error code: 7A (hexadecimal)) will be returned in the end code.

CHECK!

Response

Controller No.			Command code		End code		FCS		Terminator	
@	x	x	M	D	7	5	x	x	*	CR
3			2		2		2		2	

Name	Details
End code	Indicates the execution result for the command. 75: Specified overwrite count not exceeded 76: Specified overwrite count exceeded warning

• Example

Setting an overwrite count of FF times using subtraction Controller No. 2 address 0010h.

Command

Controller No.			Command code		Mode setting	Channel designation	Start address				Number of refreshes		FCS		Terminator	
@	0	2	M	D	S	1	0	0	1	0	F	F	2	8	*	CR
3			2		1	1	4				2		2		2	

Response

Controller No.			Command code		End code		FCS		Terminator	
@	0	2	M	D	7	5	4	9	*	CR
3			2		2		2		2	

Communications Subcommands

COMMAND PROCESSING ABORT (AA)

Aborts processing of an AUTO command being executed and returns to the command standby status.

Command

Controller No.	Command code	FCS	Terminator
@ × ×	A A	× ×	* CR
3	2	2	2

Response

Controller No.	Command code	End code	FCS	Terminator
@ × ×	A A	0 0	× ×	* CR
3	2	2	2	2

Name	Details
End code	Indicates the execution result for the command. 14: AUTO command processing not executed. 75: Aborted as a result of Tag not being in range.

- **Example**

Aborting AUTO command processing during execution in Controller No. 2.

Command

Controller No.	Command code	FCS	Terminator
@ 0 2	A A	3 6	* CR
3	2	2	2

Response

Controller No.	Command code	End code	FCS	Terminator
@ 0 2	A A	7 5	4 0	* CR
3	2	2	2	2

Controller Control Commands

CONTROLLER CONTROL (CC)

This command reads the status of the input terminals.

Command

Controller No.	Command code	Processing code	FCS	Terminator
@ x x	C C	0 0 0 0	x x	* CR
3	2	4	2	2

Name	Details
Processing code	Always 0000

Response

Controller No.	Command code	End code	Input status	Output status	FCS	Terminator
@ x x	C C	0 0	x x	0 0	x x	* CR
3	2	2	2	2	2	2

Name	Details
End code	Indicates the execution result for the command. The end code 00 indicates normal completion.
Input status	Indicates the present input status Leftmost digit: 1 (ON), 0 (OFF) Rightmost digit: 1 (ON), 0 (OFF)
Output status	Always 00

• **Example**

Displaying the present input status for Controller No. 2.

Command

Controller No.	Command code	Processing code	FCS	Terminator
@ 0 2	C C	0 0 0 0	4 2	* CR
3	2	4	2	2

Response

Controller No.	Command code	End code	Input status	Output status	FCS	Terminator
@ 0 2	C C	7 5	1 1	0 0	4 0	* CR
3	2	2	2	2	2	2

TEST (TS)

Returns the message sent by the host device as is. The TEST command is used to test communications between the host device and Controller.

Command

Controller No.	Command code	Message data	FCS	Terminator
@ x x 3	T S 2 n	x x 2	* CR 2

Name	Details
Message data	Any character string for testing communications.

Response

Controller No.	Command code	Message data	FCS	Terminator
@ x x 3	T S 2 n	x x 2	* CR 2

Name	Details
Message data	Returns the test message sent with the command.

• Example

Sending the message data "OMRON" from Controller No. 2.

Command

Controller No.	Command code	Message data	FCS	Terminator
@ 0 2 3	T S 2	O M R O N 5	1 4 2	* CR 2

Response

Controller No.	Command code	Message data	FCS	Terminator
@ 0 2 3	T S 2	O M R O N 5	1 4 2	* CR 2

ABORT (XZ)

This command resets the Controller.

Command

Controller No.	Command code	FCS	Terminator
@ × ×	X Z	× ×	* CR
3	2	2	2

Response

None

• Example

Resetting Controller No. 2.

Command

Controller No.	Command code	FCS	Terminator
@ 0 2	X Z	4 0	* CR
3	2	2	2

Response

None

Other Commands

UNDEFINED COMMAND RESPONSE (IC)

If the Controller receives a command code that is not in the list of commands, the Controller will return a response for the undefined command to the host device.

Response

Controller No.	Command code	FCS	Terminator
@ × ×	I C	× ×	* CR
3	2	2	2

Section 5

Troubleshooting

❖ Self-diagnostic Function	78
❖ Errors and Countermeasures	79
❖ Maintenance and Inspection	80
❖ Troubleshooting	81

Self-diagnostic Function

The Controller has a self-diagnostic function to check a variety of items in order to reduce the downtime of the system that may result due to operational failures.

Details of Errors





























Errors detected by the Controller can be classified into fatal errors and nonfatal errors.

- **Fatal Errors**

If the hardware of the Controller fails, the operation of the CPU Unit will be interrupted and the ERR indicator will turn ON or flash.

- **Nonfatal Errors**

If an error occurs in communications between the Controller and host device or between the Antenna and Tag, the ERR indicator will turn ON.

Error type	Item	Indicator			
		RUN	COMM	NORM	ERR
Normal operation	Awaiting command				
	Communicating with Tag				
	Normal completion of communications with Tag				
Fatal error	CPU error				
	Memory error				
Nonfatal error	Communications error between Antenna and Tag				
	Communications error between Controller and host device				

 : Lit

 : Not lit

 : Flashing

Errors and Countermeasures

The seven main causes of problems that may occur in the V680 Series are as follows:

- Noise interference Take adequate countermeasures against noise.
 - External device failure
 - Controller failure
 - Antenna failure
 - Cable failure
 - Tag failure
 - Others
- } Repairs are required.

Noise Interference

If the system malfunctions due to noise, refer to the following table and take appropriate countermeasures.

No.	Occurrence of fault	Possible cause	Countermeasure
1	Occurs when a heavy-duty motor, transformer, or capacitor is turned ON.	An instantaneous voltage drop due to inrush current to the heavy load.	<ul style="list-style-type: none"> • Increase the capacity of the power supply and the size of the power cable.
		Common mode noise as a result of the above cause.	<ul style="list-style-type: none"> • Provide the power through a 1-to-1 non-grounded insulating transformer. • Do not use the same ground as other large-capacity devices. Independently ground the Controller at a resistance of 100 Ω or less.
2	Occurs irregularly	Noise on power line	<ul style="list-style-type: none"> • Provide the power through a 1-to-1 non-grounded insulating transformer or noise filter. • Do not use the same ground as other large-capacity devices. Independently ground the Controller at a resistance of 100 Ω or less.
		Multiple V680-series Antennas	<ul style="list-style-type: none"> • Provide sufficient space between Antennas when operating multiple V680-series Antennas.

Section 5
Errors and Countermeasures

Improvement in Grounding

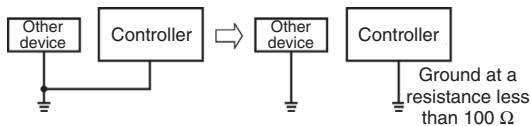

Countermeasures Against Noise on Power Line

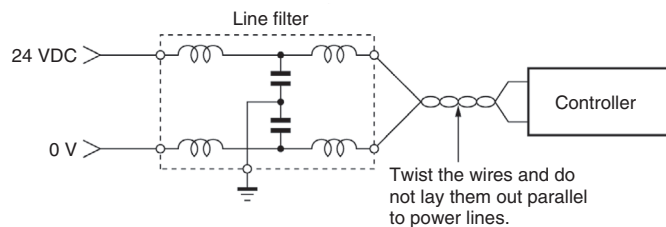

Maintenance and Inspection

The V680 Series must be inspected on a daily or regular basis so that the functions of the V680 Series can be used in good condition.

The V680 Series consists of semiconductors that last almost indefinitely. The following malfunctions may, however, result due to the operating environment and conditions.

- (1) Element deterioration due to overvoltage or overcurrent.
- (2) Element deterioration due to continuous stress caused by high ambient temperature.
- (3) Connector contact faults or insulation deterioration due to humidity and dust.
- (4) Connector contact faults or element corrosion due to corrosive gas.

Inspection Items

Item		Detail	Criteria	Required equipment
Supply voltage fluctuation		Check that the supply voltage fluctuation at the power supply terminal block is within the permissible range.	Within supply voltage specified range	Multimeter
		Check that there are no frequent instantaneous power failures or radical voltage fluctuations.	Within permissible voltage fluctuation range	Power supply analyzer
Ambient environment	Temperature	Within the specified range	Within the specified range	Maximum and minimum thermometer Hygrometer
	Humidity			
	Vibration and shock	Influence of vibration or impact of machines		
	Dust	Check that the system is free of accumulated dust and foreign particles.	Neither is permitted.	
	Corrosive gas	Check that no metal part of the system is discolored or corroded.		
Panel condition	Ventilation	Check that the system is ventilated properly with natural ventilation, forced ventilation, or cooling air.	The interior temperature must be within a range between -10°C and 55°C with proper ventilation.	---
	Damage to packing for any enclosed construction	Check that the panel packing is properly attached with no damage.	The packing has no damage.	
I/O power supply	Voltage fluctuation	Check on the I/O terminal block that the voltage fluctuation and ripple are within the permissible ranges.	Within the specified range	Multimeter Oscilloscope
	Ripple			
Mounting condition		Check that each device is securely mounted.	No loose screws	---
		Check that each connector is fully inserted.	Each connector is locked or securely tightened with screws.	
		Check that no wire is broken or nearly broken.	No wire that is broken or nearly broken.	---
		Check that no screw of the terminal block is loose.	No loose screws	---
		Check that the distance between the Tag and Antenna is within the specified range.	Within the specified range	---
		Check that the GR terminal is grounded.	The terminal must be grounded to a resistance of $100\ \Omega$ or less.	---

Troubleshooting

If an error results, fully check the whole situation, determine the relationship between the system and any other device, and refer to the following flowcharts for troubleshooting procedures.

Main Check Flowchart

Use the following main check flowchart to determine the cause of the error.

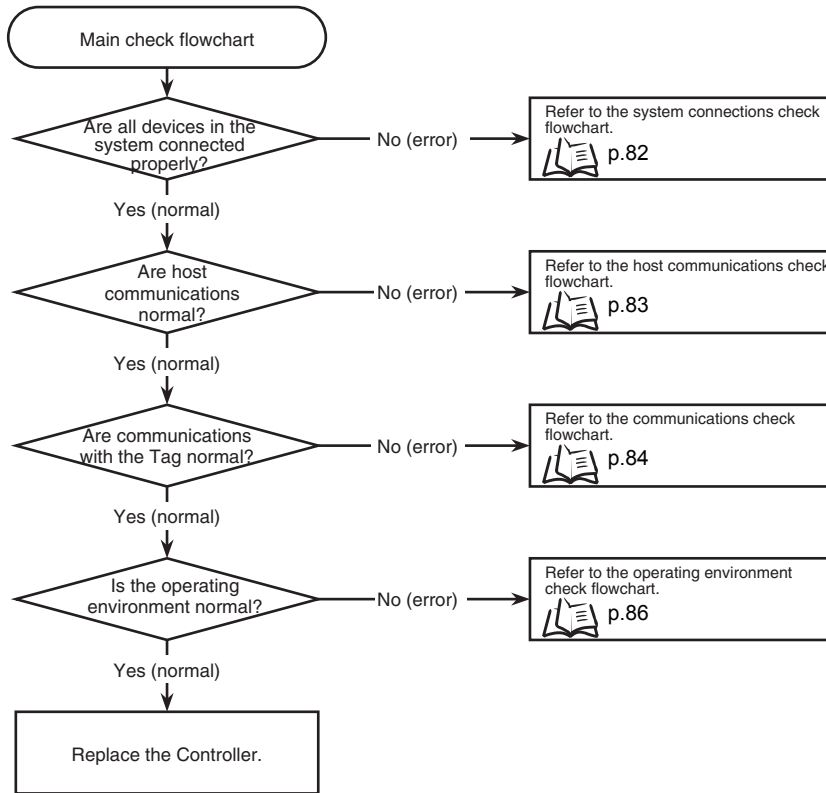

System Connections Check Flowchart

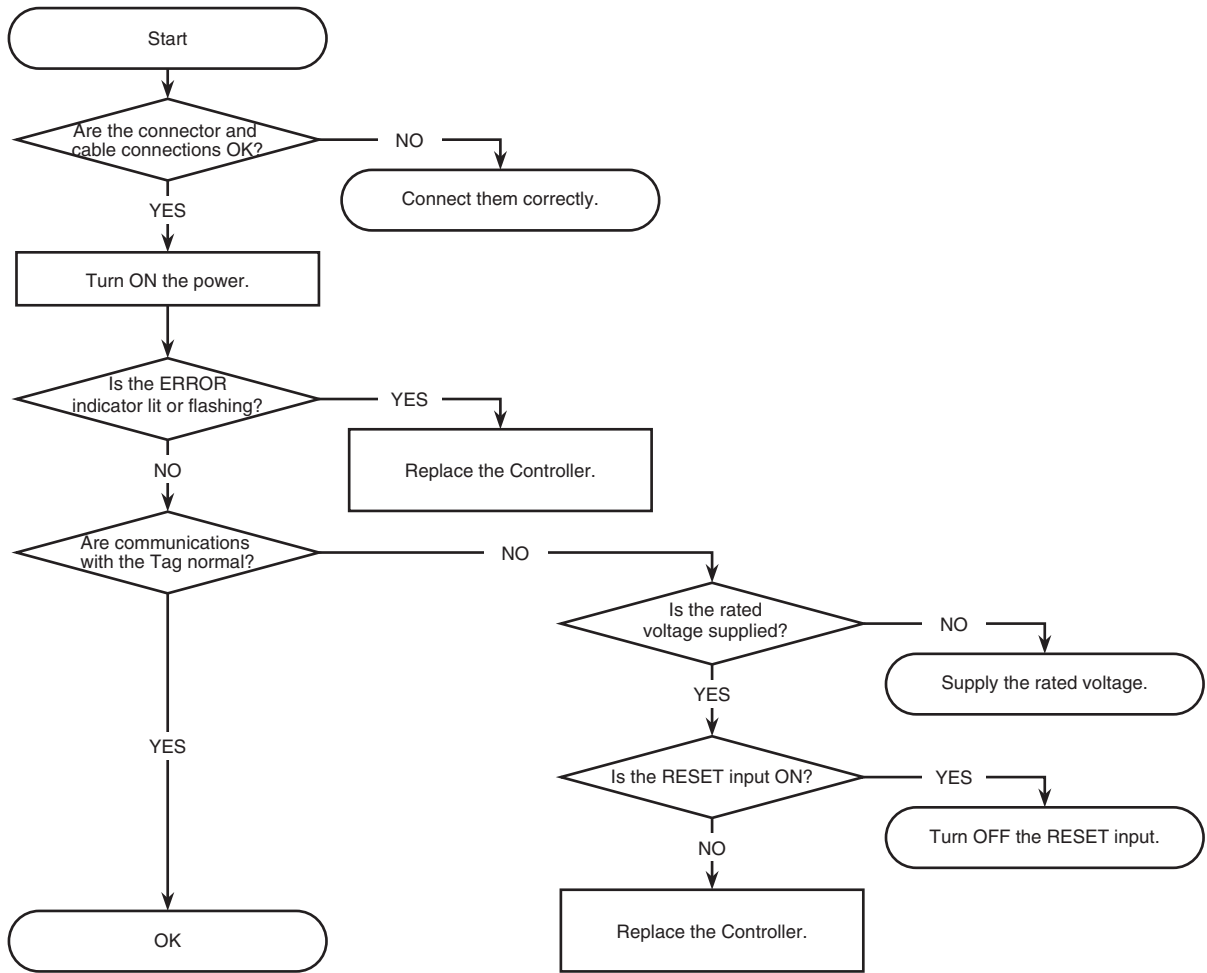

Host Communications Check Flowchart

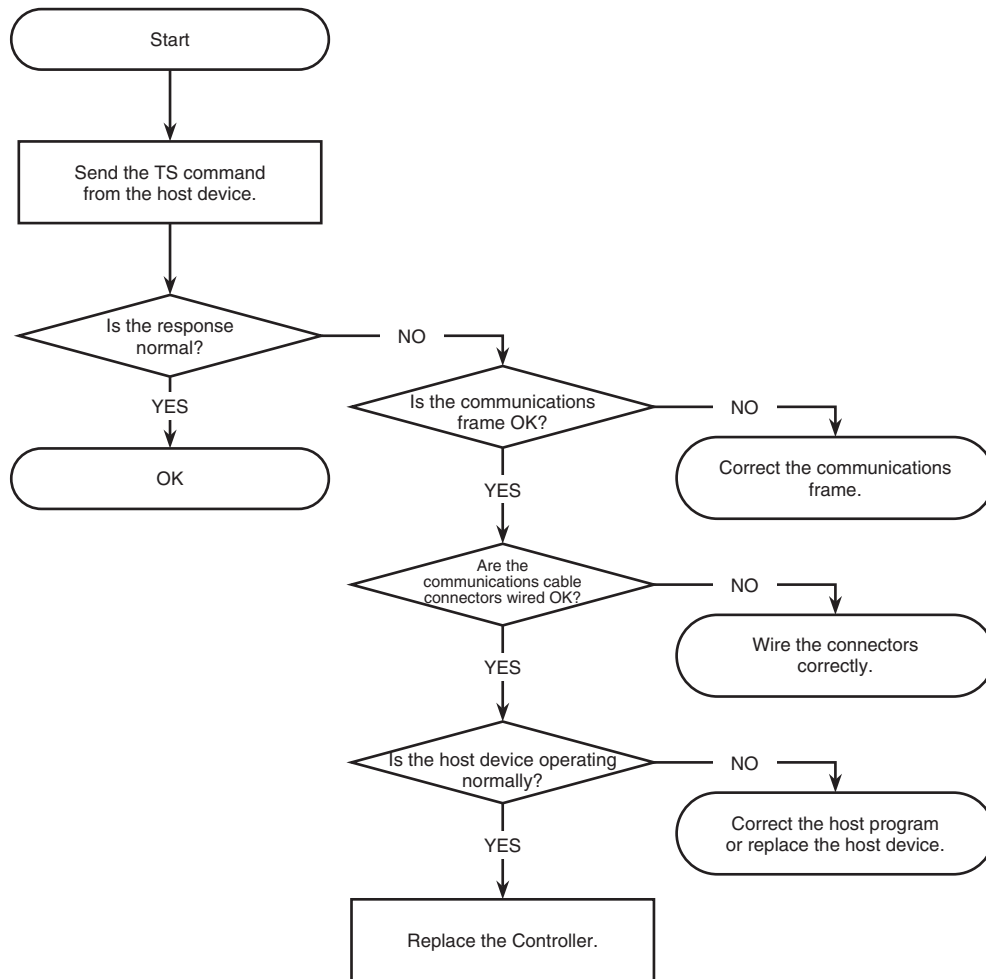

Communications Check Flowchart



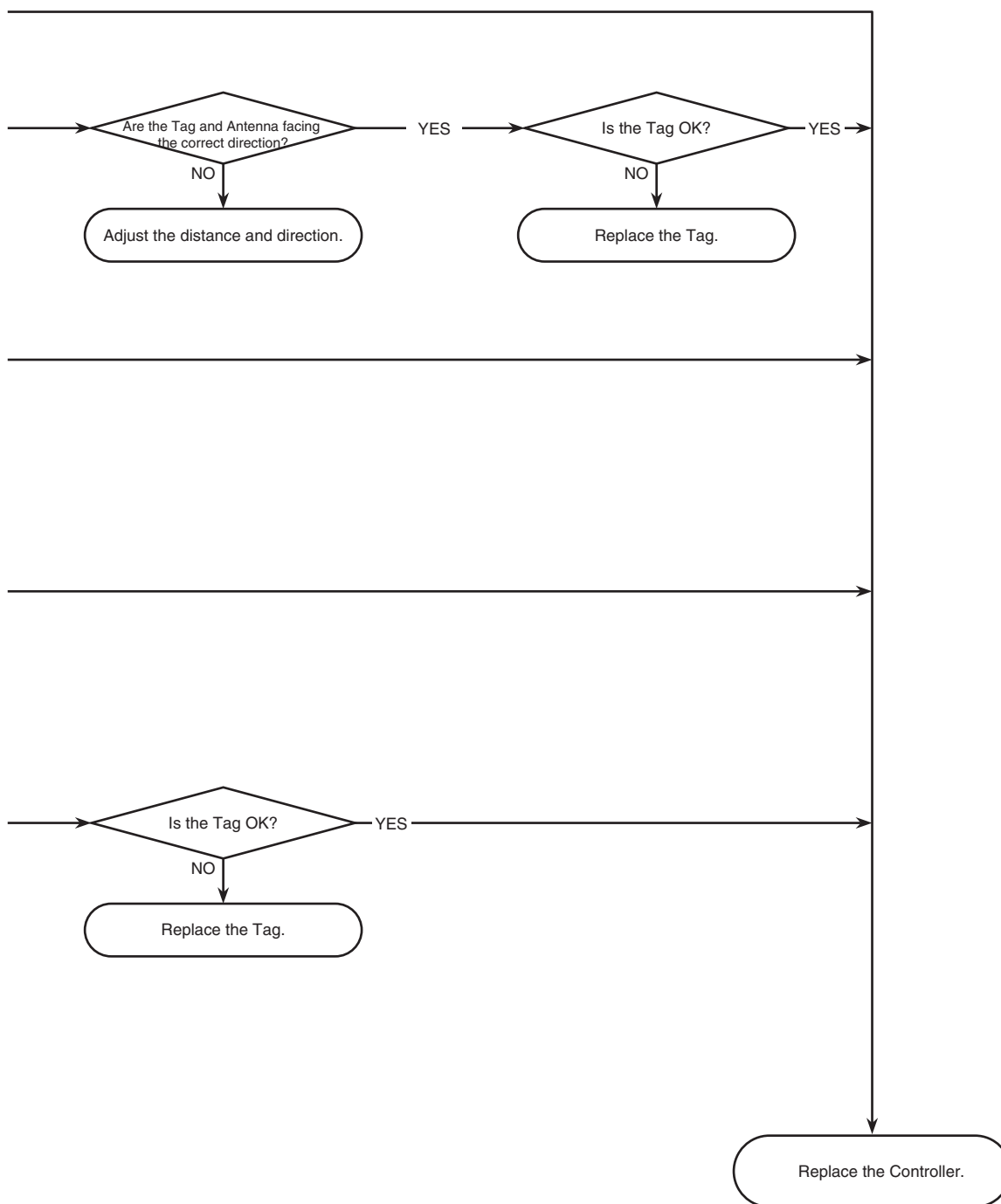

Operating Environment Check Flowchart

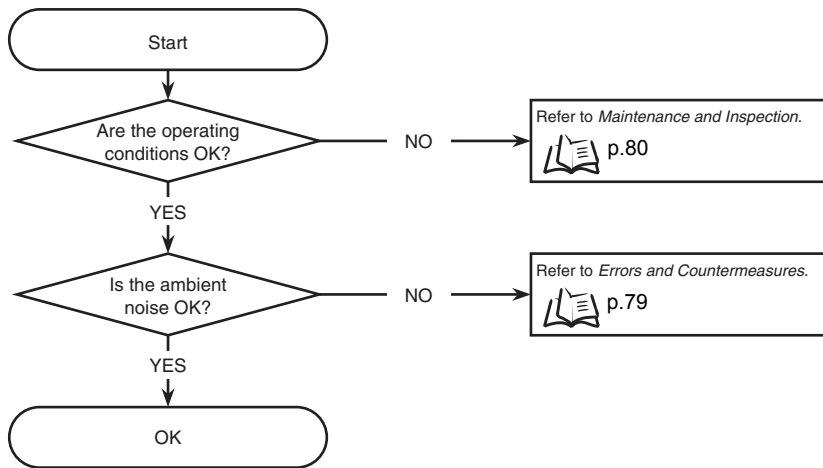

Section 6

Appendices

☒ Specifications and Dimensions	88
Controller	88
Read/Write Antenna	91
Cable	93
Communications Specifications	94
Tags	95
☒ Characteristics According to Operating Conditions	98
Communications Area (Reference)	98
Communications Time and Turn Around Time	99
Calculating Tag Movement Speed	100
Influence of Metal behind Antenna (Reference)	101
Mutual Interference between Antennas (Reference)	101
Influence of Metal Behind Tag (Reference)	102
Mutual Interference with Tag (Reference)	103
Influence of Tag Angle (Reference)	103
☒ JIS8 Unit Code Table (ASCII)	105
☒ Degree of Protection	106

Specifications and Dimensions

Controller

- General Specifications

Item	Specifications
Supply voltage	24 VDC $+10\%/ -15\%$
Power consumption	20 W max.
Insulation resistance	20 M Ω min. (at 100 VDC) between the ground and power supply terminals, between the power supply terminals and I/O terminals, between the power supply terminals and casing, between the I/O terminals and ground, between the I/O terminals and casing, and between the ground terminal and casing.
Dielectric strength	500 VAC (50/60 Hz) for 1 minute in any of the above combinations (inrush current: 10 mA max.)
Vibration resistance	Destruction: 10 to 150 Hz, 0.2-mm double amplitude at 20 m/s ² in X, Y, and Z directions ten sweeps each for 8 minutes
Shock resistance	Destruction: 150 m/s ² in X, Y, and Z directions 3 times each (total of 18 times)
Ambient operating temperature	-10°C to +55°C (with no icing)
Ambient operating humidity	35% to 85% (with no condensation)
Ambient storage temperature	-25°C to +65°C (with no icing)
Ground	Ground at a resistance of less than 100 Ω
Construction	Panel-mounting
Material	PC/ASA resin
Weight	Approx. 290 g
Number of connectable Antennas	1

- Performance Specifications

Item	Specifications
Self-diagnostics	CPU errors, host communications errors, Tag communications errors

- I/O Specifications

Input Specifications (RESET, External Input (IN1, IN2))

Input voltage	24 VDC $+10\%$ (including ripple) -15%
Input impedance	2.2 K Ω
Input current	10 mA TYP (24 VDC)
ON voltage	19 V min.
OFF voltage	5 V max.
Input response time	70 ms max.

Circuit Configuration

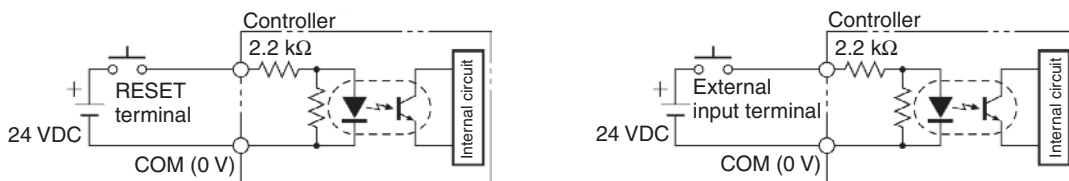

Wiring Example

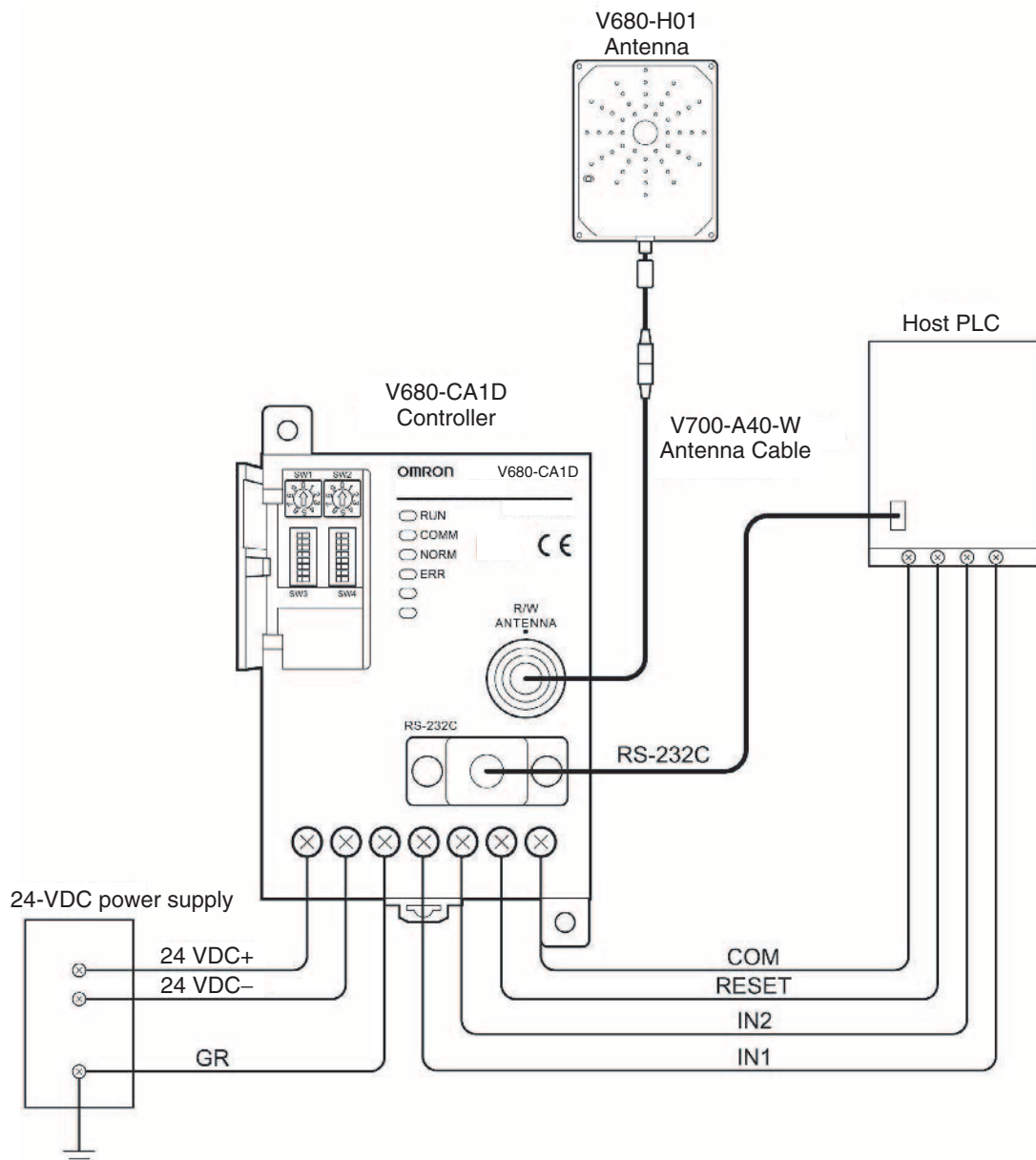

Dimensions

The V680-CA1D and V680-CA2D have the same appearance.

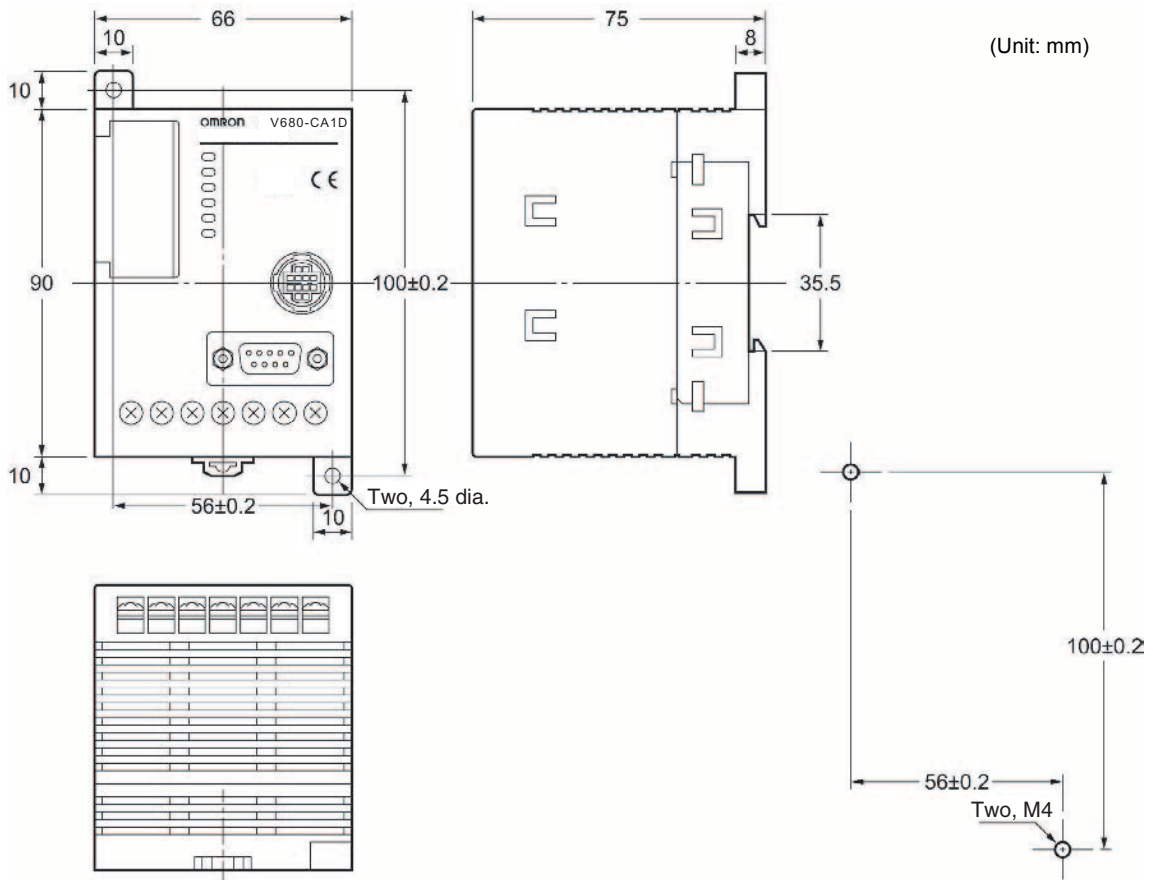

Read/Write Antenna

• General Specifications

Item	Model	V680-H01
Ambient operating temperature		-10°C to +55°C (with no icing)
Ambient storage temperature		-35°C to +65°C (with no icing)
Ambient operating humidity		35% to 85% (with no condensation)
Insulation resistance		20 MΩ min. (at 100 VDC) between the rear plate and casing
Dielectric strength		1,000 VAC (50/60Hz) between the rear plate and casing, leakage current of 1 mA max.
Degree of protection		IP63 (IEC 60529); Mounting direction: Communications surface facing up
Vibration resistance		Destruction: 10 to 150 Hz, 0.7-mm double amplitude at 50 m/s ² in X, Y, and Z directions (up/down, left/right, forward/backward) four times each for 8 minutes
Shock resistance		Destruction: 150 m/s ² three times each in X, Y, and Z directions (up/down, left/right, forward/backward)
Cable length		0.5 m (use an extension cable to connect to the Controller up to 30.1 m)
LED indicators		Power supply: Green Communications: Orange
Weight		Approx. 900 g

• Communications Specifications

Item	Model	V680-H01
Communications method		Electromagnetic induction
Operating frequency		13.56 MHz ±7 KHz
Modulation		ASK

* Communications may be affected by noise depending on the communications distance, ambient noise, and surrounding materials.

• Communications Distance

Controller	Antenna	Tag	Communications distance
V680-CA1D V680-CA2D	V680-H01	V680-D1KP58HT	0 to 150 mm

Measurement Conditions

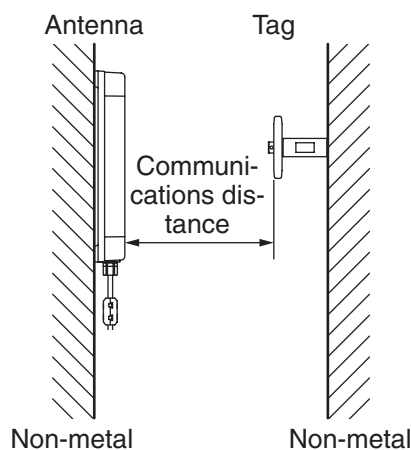

• Dimensions
V680-H01

(Unit: mm)

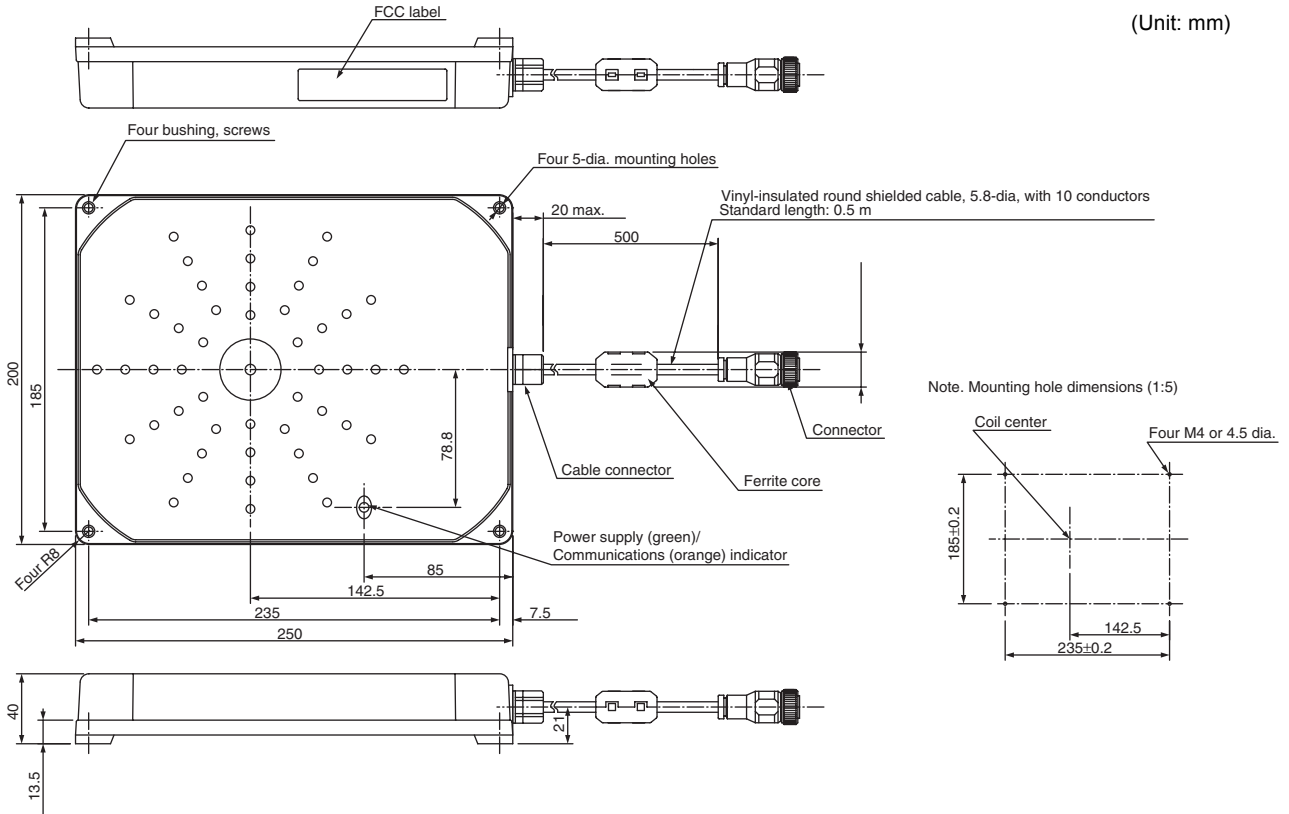

Casing material	PC/ASA resin
Rear panel	Aluminum
Cable	PVC

Cable

- Specifications

Item	Model	V700-A40-W
Number of conductors		10
Insulation resistance		5 MΩ min. (at 500 VDC) between terminals and sheath
Dielectric strength		500 VAC, 1 min

- Dimensions

Item	Model	V700-A40-W 2M	V700-A40-W 5M	V700-A40-W 10M	V700-A40-W 20M	V700-A40-W 30M
Length		Approx. 2 m	Approx. 5 m	Approx. 10 m	Approx. 20 m	Approx. 30 m
Weight		Approx. 150 g	Approx. 360 g	Approx. 700 g	Approx. 1,350 g	Approx. 2,000 g
L1		2000	5000	10000	20000	30000

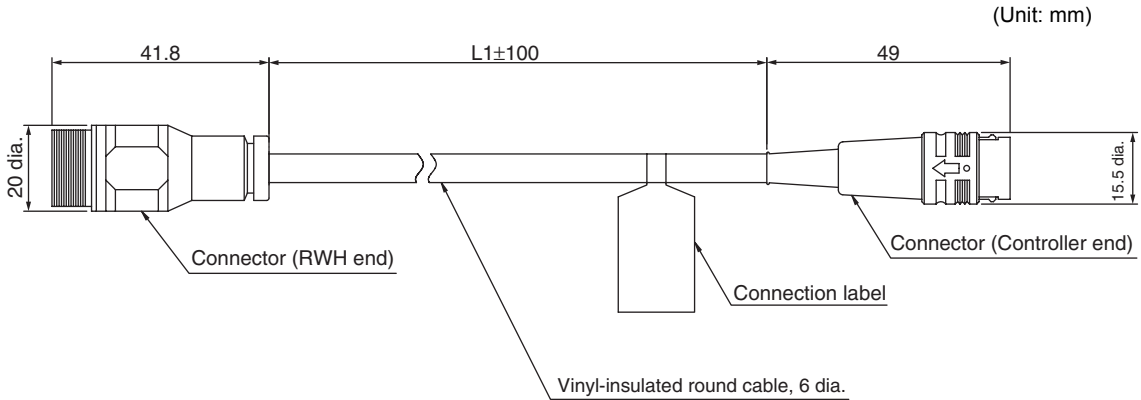

Casing material	PVC
-----------------	-----

Communications Specifications

• V680-CA1D

- The Controller can be connected to general-purpose personal computers and PLCs via the RS-232C interface.

Item	Specifications
Conforming standards	RS-232C
Communications method	EIA/TIA-232-E, 1-to-N half duplex
Baud rate	9,600 bps, 19,200 bps, 38,400 bps, 115,200 bps (See note.)
Synchronization method	Start-stop synchronization with 1 stop bit or 2 stop bits (See note.)
Transmission code	7-bit ASCII or 8-bit JIS (See note.)
Maximum connectable number of Controllers	10
Cable length	15 m max.
Suitable connector	D-sub 9-pin male connector OMRON XM2A-0901 Plug and XM2S-0911 Hood (1 set) provided with the Controller
Recommended cable	Hitachi Cable CO-MA-VV-SB 5Px28AWG

* These settings can be made using the Controller's DIP switch. Refer to *DIP Switch Settings* for details on setting methods.



• V680-CA2D

- The Controller can be connected to general-purpose personal computers and PLCs via the RS-485 interface.

Item	Specifications
Conforming standards	RS-485
Communications method	EIA RS-485, 1-to-N half duplex, two-wire bidirectional
Baud rate	9,600 bps, 19,200 bps, 38,400 bps, or 115,200 bps (See note.)
Synchronization method	Start-stop synchronization with 1 stop bit or 2 stop bits (See note.)
Transmission code	7-bit ASCII or 8-bit JIS (See note.)
Maximum connectable number of Controllers	10
Cable length	300 m max.
Suitable connector	Nihon Weidmuller Co.,Ltd. BLZ4CA2D (1 set) provided with the Controller
Recommended cable	Tachii Electric Wire Co., Ltd. MVVS2CX0.5Sq

* These settings can be made using the Controller's DIP switch. Refer to *DIP Switch Settings* for details on setting methods.



CHECK!

If the V680-CA2D is not used with the recommended cable (MVVS2CX0.5Sq), use an equivalent product with shielded, twisted-pair wires with a gage of AWG20.

Tags

• Specifications

Item	Model	V680-D1KP58HT
Memory capacity		1,000 bytes (user area)
Memory type		EEPROM
Data backup time	10 years after writing	Total data backup time at high temperatures exceeding 110°C is 10 hours (See note.)
Data overwrite count		100,000 times per address
Ambient operating temperature (communicating)		-10°C to 85°C (with no icing)
Ambient operating temperature (not communicating)		-40°C to 110°C (with no icing)
Ambient storage temperature		-40°C to 110°C (with no icing)
Ambient operating humidity		No limits
Degree of protection		IP67 (IEC 60529)
Vibration resistance		Destruction: 10 to 2,000 Hz, 1.5-mm double amplitude at 150 m/s ² in X, Y, and Z directions ten times each for 15 minutes
Shock resistance		Destruction: 500m/s ² in ±X, ±Y, and ±Z directions three times each (total: 18 times)
Material		Coating: PPS resin
Weight		Approx. 90 g

* After storing data at high temperatures, rewrite the data even if changes are not required. In this manual, high temperatures are those exceeding 110°C up to 200°C.



The maximum operating temperature during communication is 85°C. The temperature of the actual Tag must not be higher than 85°C when the Tag enters the Antenna's communications area. When using a Tag after storage at high temperature, perform tests before use, and make sure that the temperature of the Tag does not exceed 85°C during operation.

• Dimensions

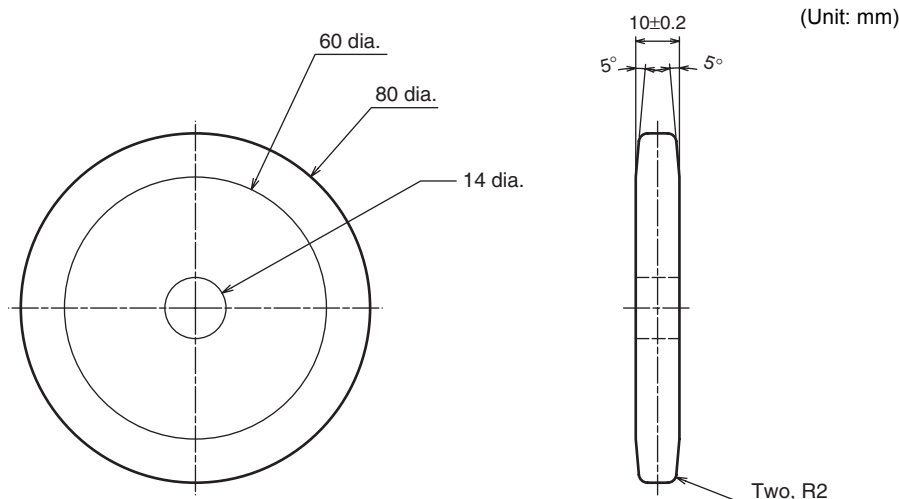

• Tag Heat Resistivity

- Storing Tags under high temperatures will adversely affect the performance of the internal parts and the service life of the Tags.
- An LTPD of 10% was determined during the evaluation for Tags that reached the end of their life after testing under the following test conditions
Heat cycle: Room temperature/200°C, 30 minutes each for 2,000 cycles
- Normal operation has been confirmed after performing the above tests, although minor cracks may occur.



LTPD: Lot tolerance percent defective

The lower limit of the malfunction rate for lots to be considered unacceptable during reliability testing.

- Reference Data (Evaluation Test Results)

Heat Resistance Evaluation Results
Defective Operation

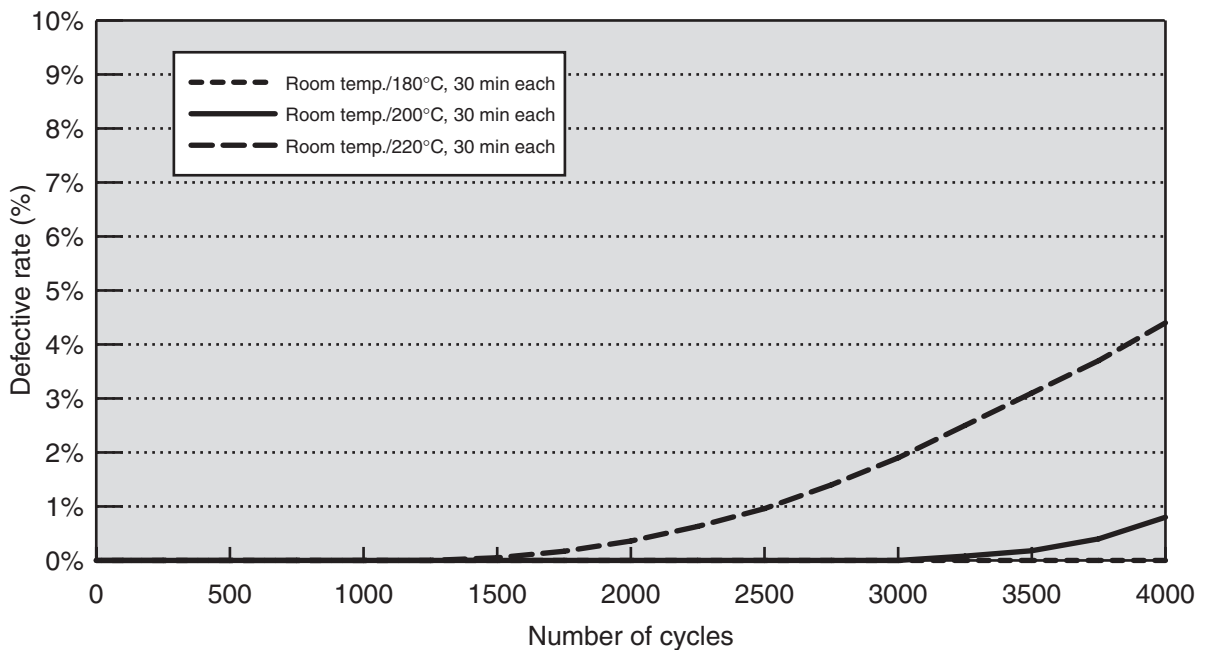

• V680-A80 Attachment for V680-D1KP58HT Tag

This Attachment is specifically designed to secure V680-D1KP58HT Tags to the workpiece.

Applicable Tag model: V680-D1KP58HT

Dimensions

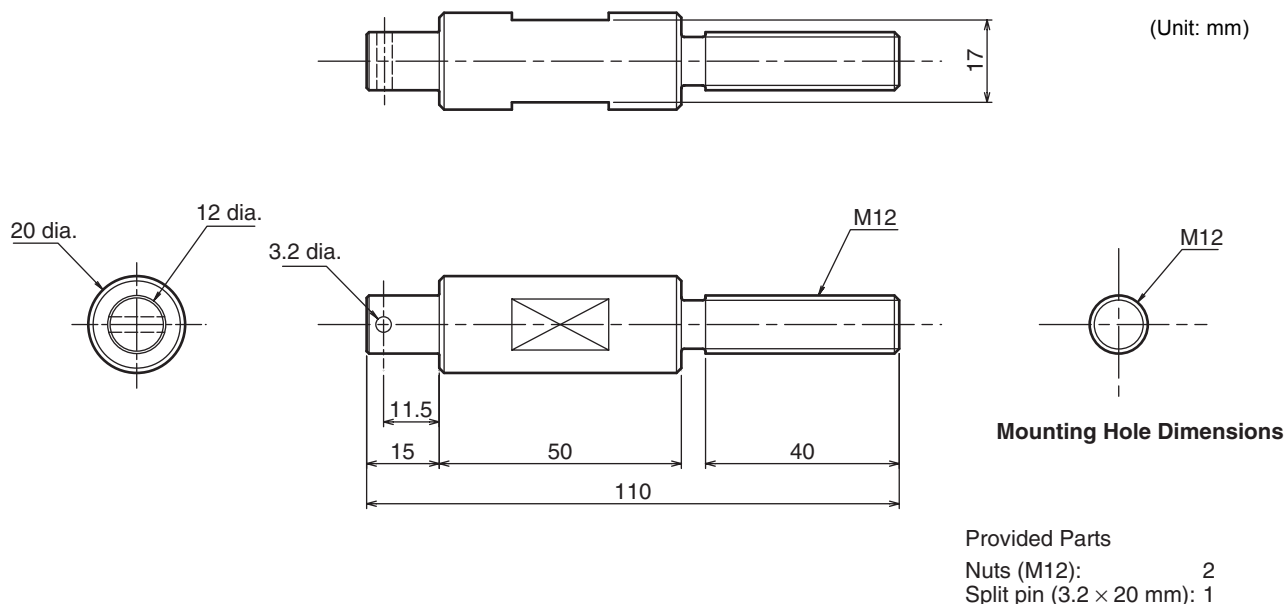

General Specifications

Conforms to the specifications for the Tag.

Influence of Metal behind Tags

Use of this Attachment increases the distance between the Tag and the metal surface to approx. 50 mm. For metal workpieces, refer to *Influence of Metal Behind Tag (Reference)* before using the Attachment.

p.102

Characteristics According to Operating Conditions

Communications Area (Reference)

The following diagram shows the communications area for the V680-H01. The communications area depends on the installation conditions and environmental conditions.

- V680-H01 → V680-D1KP58HT

The following diagram shows the communications area when a Tag passes by and perpendicular to the center of the Antenna. The Antenna and Tag surfaces are parallel to each other.

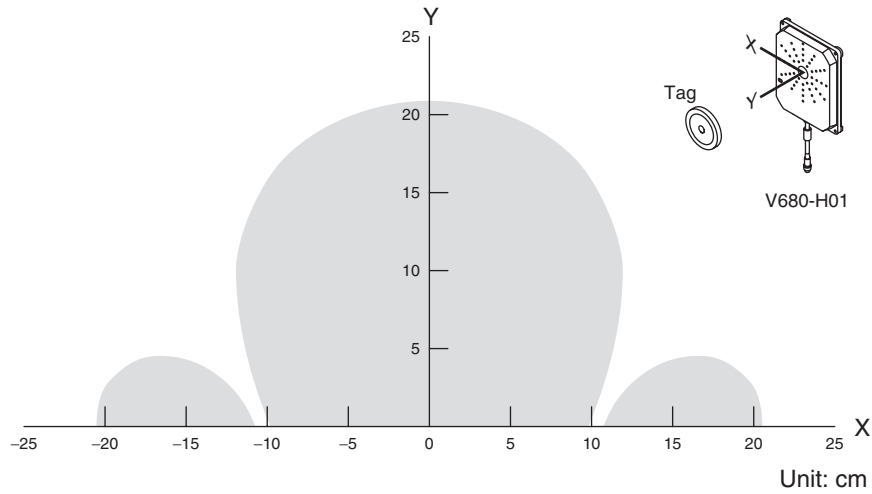

Communications Time and Turn Around Time

- The TAT (Turn Around Time) includes the communications time.
- The communication time does not include communications with the host. The communications time is the time required for communications between the Antenna and the Tag. This time is used for reference when calculating the movement speed for AUTO commands.

Example:



• Communications Time

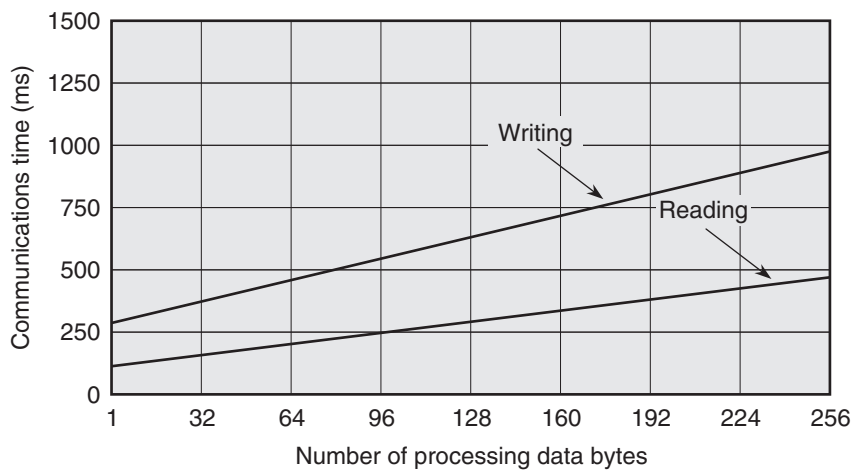

• TAT

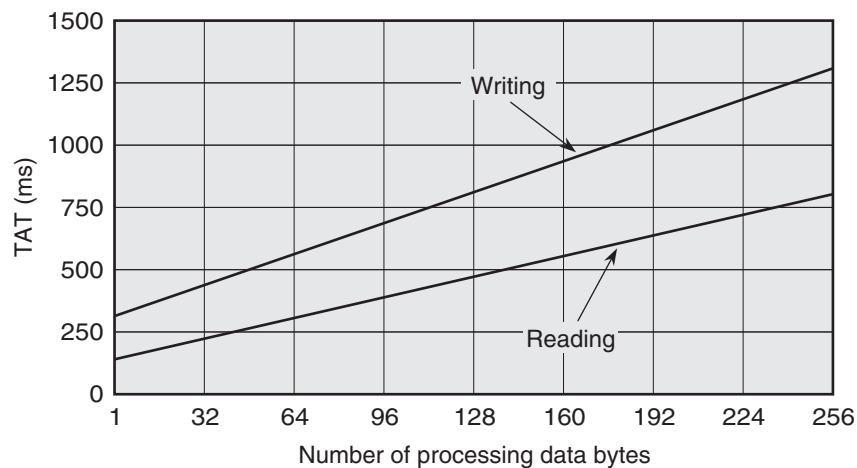

	Communications time (ms) N: number of processing bytes	TAT (ms) N: number of processing bytes
Read	$T = 1.4 N + 114$	$T = 2.6 N + 140$
Write	$T = 2.7 N + 284$	$T = 3.9 N + 310$



- The TAT graph data shown here is an example for a V680-CA1D/CA2D Controller communicating with a host with a baud rate of 9,600 bps, 1 start bit, data length of 7 bits, 2 stop bits, even parity, and no spaces between characters.
- The number of TAT data bytes is the number of bytes when ASCII is specified as the code.

Calculating Tag Movement Speed

When communicating with a moving Tag, specify auto or repeat as the communications designation. The maximum movement speed for the Tag at this time can be calculated simply using the following formula.

$$\text{Maximum movement speed} = \frac{D \text{ (Movement range within communications area)}}{T \text{ (Communications time)}} \times \text{Safety rate (0.5)}$$

D (movement distance within the communications area) is calculated from the actual measurement or communications area between the Antenna and Tag.

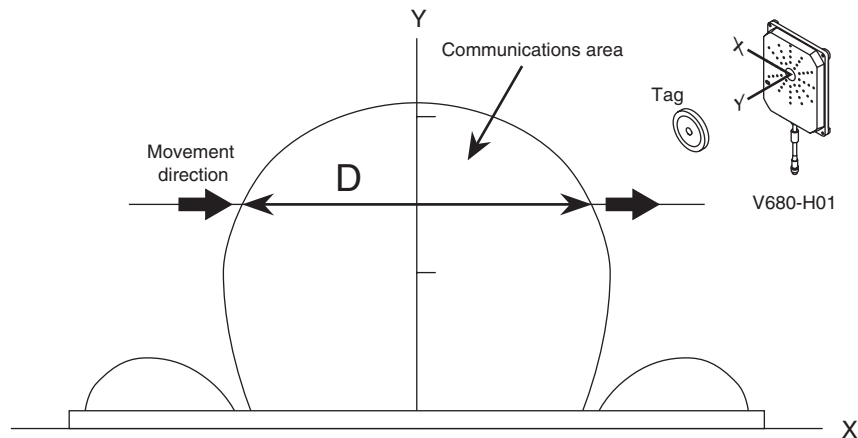

As noise countermeasures, the Reader/Writer will perform resend processing as internal software processing if a communications error occurs between the Tag and Antenna. Therefore, the communications time will depend on the onsite ambient noise, so be sure to check with actual equipment beforehand. The communications area calculation may not be executed as resend processing.

Influence of Metal behind Antenna (Reference)

If the Antenna is mounted to a metal object, the communications area will be reduced by approximately 10% compared with mounting to a non-metal object. Consider this influence on performance when mounting the Antenna.

Mutual Interference between Antennas (Reference)

When installing multiple Read/Write Antennas adjacently, make sure that the Antenna communications area do not overlap.

For details on the Antenna communications area, refer to *Communications Area (Reference)*.

As a guide, the following diagrams show the minimum distances required between two Antennas installed facing each other or in parallel. Be sure to provide the distance between Antennas shown here.

- Installing the Antennas Facing Each Other

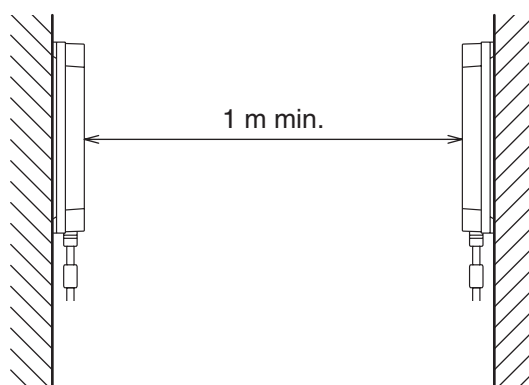

- Installing the Antennas in Parallel

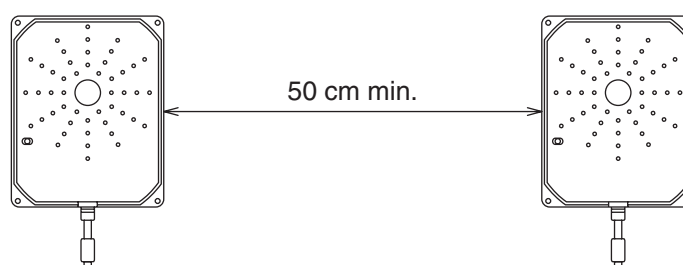

Influence of Metal Behind Tag (Reference)

Take the influence of metal behind Tags into consideration when mounting them.

The communications distance is adversely affected if there is any metal material around the Tag. The degree of influence depends on the type, size, and shape of the material around the Tag. The following graphs show the influence of metal objects behind the Tag for reference.

• Influence of Metal

The following diagram shows the rate of reduction in the communications distance when metal is located behind the Tag. The horizontal axis in the diagram indicates the distance between the Tag and the metal plate, and the vertical axis indicates the relative communications distance at 100% without a metal plate, i.e, the rate of reduction in communications distance.

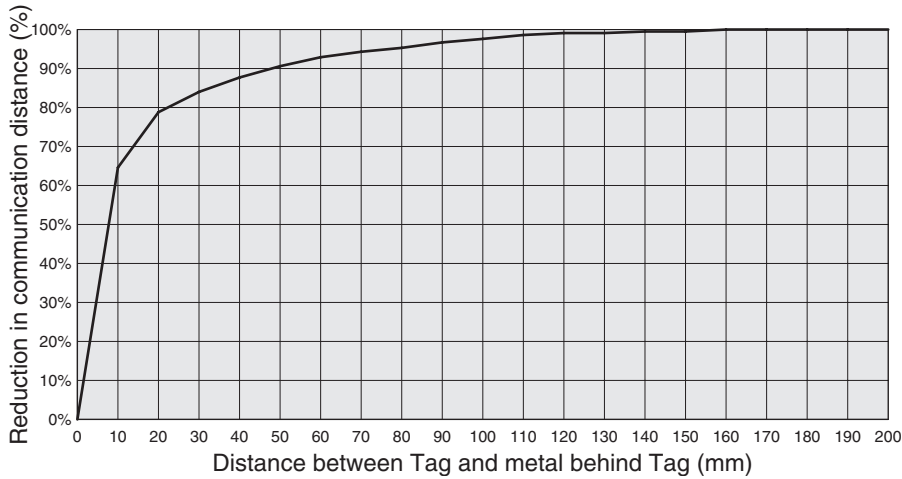

Test Setup

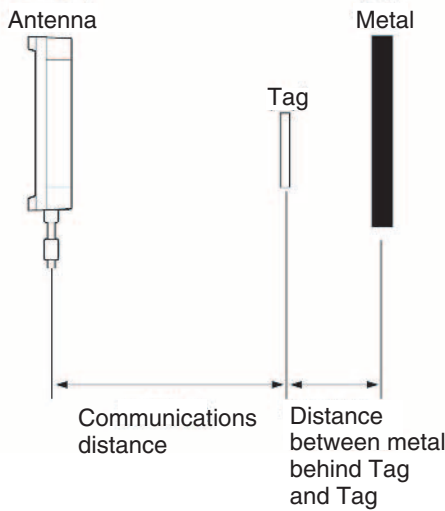

Material: Steel (t = 1.5 mm)

Shape: 295 mm × 295 mm

Mutual Interference with Tag (Reference)

Provide the mounting distances indicated below to prevent malfunctions due to mutual interference when using multiple Tags.

V680-D1KP58HT

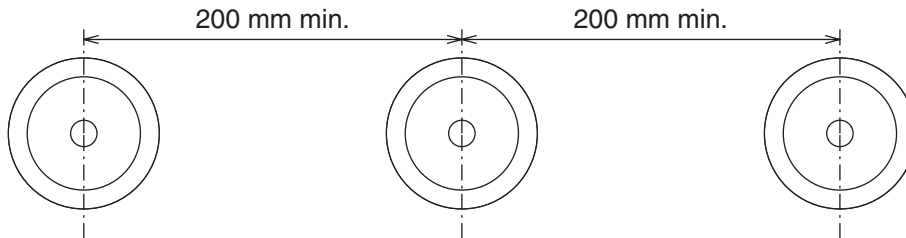

Influence of Tag Angle (Reference)

The maximum communications distance can be obtained when the Antenna and Tag are installed in parallel. When the Tag is installed on an angle, the communications distance is reduced. Consider the effect of the Tag angle when installing the Tag. As reference data, the following diagram shows the rate of reduction in communications distance according to the Tag angle. The horizontal axis indicates the angle when the Tag surface and Antenna surface are in parallel at 0°. The vertical axis indicates the relative communications distance when the angle is 0° at 100%, i.e., the rate in reduction of the communications distance.

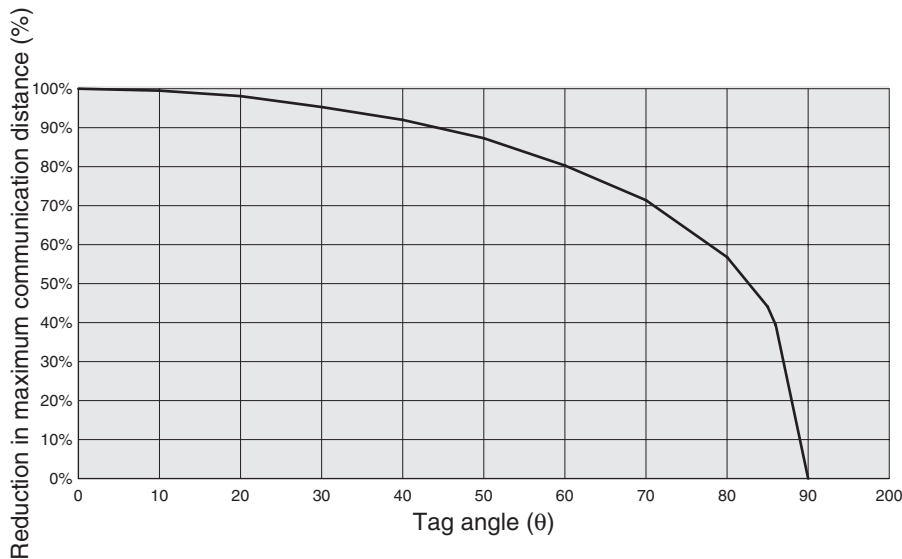

Test Setup

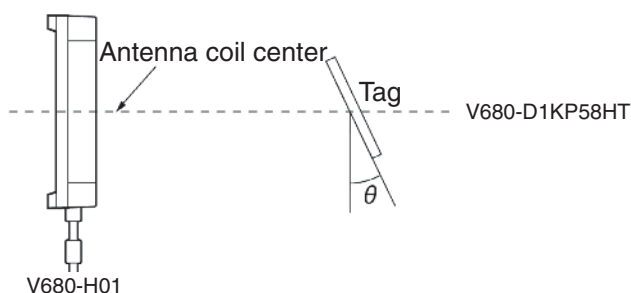

Chemical Resistance of Tags (Reference)

• V680-D1KP58HT

The V680-D1KP58HT Tag is manufactured from PPS resin. Refer to the following table and avoid any chemical substance that will adversely affect PPS resin.

Chemical substance		Room temperature	90°C
Hydrochloric acid	37%	A	A
	10%	A	A
Sulfuric acid	98%	A	B
	50%	A	A
	30%	A	A
	3%	A	A
Nitric acid	60%	B	C
	40%	A	B
	10%	A	A
Aqueous hydrogen fluoride	40%	A	A
Chromic acid	40%	A	A
Aqueous hydrogen peroxide	28%	A	B
	3%	A	A
NaOH aqueous solution	60%	A	A
	10%	A	A
	1%	A	A
Aqueous ammonia	28%	A	B
	10%	A	B
Sodium chloride	10%	A	A
Sodium carbonate	20%	A	A
	2%	A	A

Chemical substance		Room temperature	90°C
Sodium hypochlorite solution		A	A
Aqueous phenol solution	5%	A	A
Glacial acetic acid		A	A
Acetic acid		A	A
Oleic acid		A	A
Methylalcohol	95%	A	A
Ethanol	95%	A	A
Ethyl acetate		A	A
Diethyl hexene sebacate		A	A
Acetone		A	A
Diethyl ether		A	A
n-heptane		A	A
2,2,4 trimethyl pentane		A	A
Benzene		A	A
Triene		A	A
Aniline		A	A
Mineral oil		A	A
Gasoline		A	A
Insulation oil		A	A
Dichloroethylene		A	A
Carbon tetrachloride		A	A

A: No effect

B: May change color or swell

C: May deform or crack



This table shows changes over time when PPS resin was left in contact with the chemicals at room temperature and at 90°C. If the type of chemical, concentration, or temperature is different from those indicated in this table, perform testing in advance before using the Tags in actual operation.

JIS8 Unit Code Table (ASCII)

Left-most digit Right-most digit	b8 to b5	0000	1001	0010	0011	0100	0101	0110	0111	1000	1101	1010	1011	1100	1101	1110	1111	
	b4 to b1	Column Row	0	1	2	3	4	5	6	7	8	9	10	11	12	13	14	15
0000	0	NUL	TC ₇ (DLE)	(SP)	0	@	P	`	p	Undefined	Undefined	Undefined	Undefined	Undefined	Undefined	Undefined	Undefined	Undefined
0001	1	TC ₁ (SOH)	DC ₁	!	1	A	Q	a	q									
0010	2	TC ₂ (STX)	DC ₂	"	2	B	R	b	r									
0011	3	TC ₃ (ETX)	DC ₃	#	3	C	S	c	s									
0100	4	TC ₄ (EOT)	DC ₄	\$	4	D	T	d	t									
0101	5	TC ₅ (NEQ)	TC ₈ (NAK)	%	5	E	U	e	u									
0110	6	TC ₆ (ACK)	TC ₉ (SYN)	&	6	F	V	f	v									
0111	7	BEL	TC ₁₀ (ETB)	'	7	G	W	g	w									
1000	8	FE ₀ (BS)	CAN	(8	H	X	h	x									
1001	9	FE ₁ (HT)	EM)	9	I	Y	i	y									
1010	10	FE ₂ (LF)	SUB	*	:	J	Z	j	z									
1011	11	FE ₃ (VT)	ESC	+	;	K	[k	{									
1100	12	FE ₄ (FF)	IS ₄ (FS)	,	<	L	\	l										
1101	13	FE ₅ (CR)	IS ₃ (GS)	-	=	M]	m	}									
1110	14	SO	IS ₂ (RS)	.	>	N	^	n	~									
1111	15	SI	IS ₁ (US)	/	?	O	_	o	DEL									

Degree of Protection

International protection degrees (IP-□□) are determined by the following tests. Be sure to check the sealing capability under the actual operating environment and conditions before actual use.

IP indicates the International Protection symbol.

- IEC (International Electrotechnical Commission) Standards (IEC60529 November 1989)

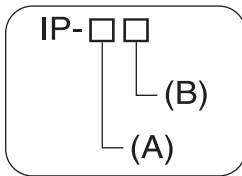









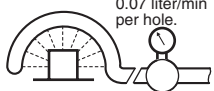

(A) First Digit: Degree of Protection from Solid Materials

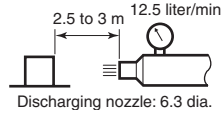
Degree	Protection	
0		No protection
1		Protects against penetration of any solid object such as a hand that is 50 mm or more in diameter.
2		Protects against penetration of any solid object, such as a finger, that is 12.5 mm or more in diameter.
3		Protects against penetration of any solid object, such as a wire, that is 2.5 mm or more in diameter.
4		Protects against penetration of any solid object, such as a wire, that is 1 mm or more in diameter.
5		Protects against penetration of dust of a quantity that may cause malfunction or obstruct the safe operation of the product.
6		Protects against penetration of all dust.

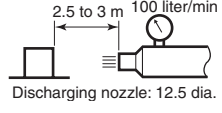
(B) Second Digit: Degree of Protection Against Water

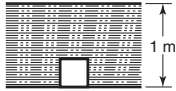
Degree	Protection		Test method (with pure water)
0	No protection	Not protected against water.	No test
1	Protection against water drops 	Protects against vertical drops of water towards the product.	Water is dropped vertically towards the product from the test machine for 10 min.
2	Protection against water drops 	Protects against drops of water approaching at a maximum angle of 15° to the left, right, back, and front from vertical towards the product.	Water is dropped for 2.5 min each (i.e., 10 min in total) towards the product inclined 15° to the left, right, back, and front from the test machine.

Degree	Protection		Test method (with pure water)
3	Protection against sprinkled water 	Protects against sprinkled water approaching at a maximum angle of 60° from vertical towards the product.	Water is sprinkled for 10 min at a maximum angle of 60° to the left and right from vertical from the test machine.  Water rate is 0.07 liter/min per hole.
4	Protection against water spray 	Protects against water spray approaching at any angle towards the product.	Water is sprayed at any angle towards the product for 10 min from the test machine.  Water rate is 0.07 liter/min per hole.
5	Protection against water jet spray 	Protects against water jet spray approaching at any angle towards the product.	Water is jet sprayed at any angle towards the product for 1 min per square meter for at least 3 min in total from the test machine.  2.5 to 3 m 12.5 liter/min Discharging nozzle: 6.3 dia.
6	Protection against high pressure water jet spray 	Protects against high-pressure water jet spray approaching at any angle towards the product.	Water is jet sprayed at any angle towards the product for 1 min per square meter for at least 3 min in total from the test machine.  2.5 to 3 m 100 liter/min Discharging nozzle: 12.5 dia.
7	Protection underwater 	Resists the penetration of water when the product is placed underwater at specified pressure for a specified time.	The product is placed 1 m deep in water (if the product is 850 mm max. in height) for 30 min. 
8	Protection underwater 	Can be used continuously underwater.	The test method is determined by the manufacturer and user.

• JEM (Japan Electrical Manufacturers Association) Standard (JEM1030: 1991)

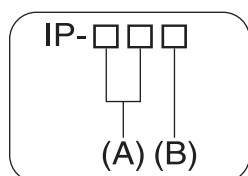

(A) Complies with 1st and 2nd symbols of IEC 60529.

(B) Protective Classification for Oil Penetration

Class	Protection	
f	Oil-resistant type	No adverse affect from oil drops or oil spray approaching from any direction.
g	Oil-proof type	Protects against penetration of oil drops or oil spray approaching from any direction.

Note: There are four other classes: “h”, “c”, “d”, and “e”.

- NEMA (National Electrical Manufacturers Association)

The following table shows the conversion from NEMA enclosure classifications to IEC 60529. (Conversion from IEC 60529 to NEMA enclosure classifications is not available.)

NEMA250	IEC 60529
1	IP10
2	IP11
3	IP54
3R	IP14
3S	IP54
4,4X	IP56
5	IP52
6,6P	IP67
12,12K	IP52
13	IP54

Revision History

A manual revision code appears as a suffix to the catalog number at the bottom of the front and rear pages.

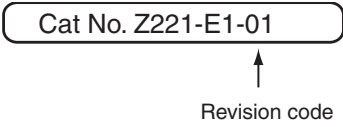

Revision code	Date	Revised contents
01	April 2005	Original production



This document provides information mainly for selecting suitable models. Please read the Instruction Sheet carefully for information that the user must understand and accept before purchase, including information on warranty, limitations of liability, and precautions.

OMRON Corporation
Industrial Automation Company

Application Sensors Division
Sensing Devices and Components Division H.Q.

Shiokoji Horikawa, Shimogyo-ku,
Kyoto, 600-8530 Japan

Tel: (81)75-344-7068/Fax: (81)75-344-7107

Regional Headquarters

OMRON EUROPE B.V.

Sensor Business Unit,
Carl-Benz-Str. 4, D-71154 Nufringen,
Germany

Tel: (49)7032-811-0/Fax: (49)7032-811-199

OMRON ELECTRONICS LLC

1 East Commerce Drive, Schaumburg, IL 60173
U.S.A.

Tel: (1)847-843-7900/Fax: (1)847-843-8568

OMRON ASIA PACIFIC PTE. LTD.

83 Clemenceau Avenue,
#11-01, UE Square,
239920 Singapore

Tel: (65)6835-3011/Fax: (65)6835-2711

OMRON CHINA CO., LTD. BEIJING OFFICE

Room 1028, Office Building,
Beijing Capital Times Square,
No. 88 West Chang'an Road,
Beijing, 100031 China

Tel: (86)10-8391-3005/Fax: (86)10-8391-3688

Authorized Distributor: