

# **USER'S MANUAL**

## **3F88L-160/162 Cam Positioner**

---

Thank you for choosing this 3F88L-160/162 Cam Positioner. Proper use and handling of the product will ensure proper product performance, will lengthen product life, and may prevent possible accidents.

Please read this manual thoroughly and handle and operate the product with care.

---

1. To ensure safe and proper use of the OMRON Cam Positioners, please read this USER'S MANUAL (Cat. No. O008-E1) to gain sufficient knowledge of the devices, safety information, and precautions before actual use.
2. The products are illustrated without covers and shieldings for closer look in this USER'S MANUAL. For actual use of the products, make sure to use the covers and shieldings as specified.
3. This USER'S MANUAL and other related user's manuals are to be delivered to the actual end users of the products.
4. Please keep this manual close at hand for future reference.
5. If the product has been left unused for a long time, please inquire at our sales representative.

## NOTICE

1. This manual describes the functions of the product and relations with other products. You should assume that anything not described in this manual is not possible.
2. Although care has been given in documenting the product, please contact your OMRON representative if you have any suggestions on improving this manual.
3. The product contains potentially dangerous parts under the cover. Do not attempt to open the cover under any circumstances. Doing so may result in injury or death and may damage the product. Never attempt to repair or disassemble the product.
4. We recommend that you add the following precautions to any instruction manuals you prepare for the system into which the product is being installed.
  - Precautions on the dangers of high-voltage equipment.
  - Precautions on touching the terminals of the product even after power has been turned off. (These terminals are live even with the power turned off.)
5. Specifications and functions may be changed without notice in order to improve product performance.

## Items to Check Before Unpacking

1. Check the following items before removing the 3F88L-160/162 Cam Positioner from the package:
  - Has the correct product been delivered (i.e., the correct model number and specifications)?
  - Has the product been damaged in shipping?
  - Are any screws or bolts loose?
  - Have all accessories been correctly delivered together with or attached to the product? The accessory for the 3F88L-160/162 Cam Positioner is the *Safety Precautions* only.

Mounting screws and other necessary parts must be provided by the customer. Should there be any problems with this product, contact your nearest OMRON sales representative.
2. Check the following items before removing the 3F88L-RS17/17T/15/15W Resolver from the package:
  - Has the correct product been delivered (i.e., the correct model number and specifications)?
  - Has the product been damaged in shipping?
  - Are any screws or bolts loose?
  - Have all accessories been correctly delivered together with or attached to the product? The accessories for the 3F88L-RS17/17T are one 3F88L-RL10 Coupling and one copy of the user's manual. The accessories for the 3F88L-RS15/15W are one 3F88L-RL6 Coupling and three mounting claws.

Should there be any problems with this product, contact your nearest OMRON sales representative.

## **Notice:**

OMRON products are manufactured for use according to proper procedures by a qualified operator and only for the purposes described in this manual.

The following conventions are used to indicate and classify precautions in this manual. Always heed the information provided with them. Failure to heed precautions can result in injury to people or damage to property.

 **DANGER** Indicates an imminently hazardous situation which, if not avoided, will result in death or serious injury. Additionally, there may be severe property damage.

 **WARNING** Indicates a potentially hazardous situation which, if not avoided, could result in death or serious injury. Additionally, there may be severe property damage.

 **Caution** Indicates a potentially hazardous situation which, if not avoided, may result in minor or moderate injury, or property damage.

## **OMRON Product References**

All OMRON products are capitalized in this manual. The word “Unit” is also capitalized when it refers to an OMRON product, regardless of whether or not it appears in the proper name of the product.

The abbreviation “Ch,” which appears in some displays and on some OMRON products, often means “word” and is abbreviated “Wd” in documentation in this sense.

The abbreviation “PC” means Programmable Controller and is not used as an abbreviation for anything else.

## **Visual Aids**

The following headings appear in the left column of the manual to help you locate different types of information.

**Note** Indicates information of particular interest for efficient and convenient operation of the product.

## **© OMRON, 1999**

All rights reserved. No part of this publication may be reproduced, stored in a retrieval system, or transmitted, in any form, or by any means, mechanical, electronic, photocopying, recording, or otherwise, without the prior written permission of OMRON.

No patent liability is assumed with respect to the use of the information contained herein. Moreover, because OMRON is constantly striving to improve its high-quality products, the information contained in this manual is subject to change without notice. Every precaution has been taken in the preparation of this manual. Nevertheless, OMRON assumes no responsibility for errors or omissions. Neither is any liability assumed for damages resulting from the use of the information contained in this publication.

## ***Intended Audience***

This manual is intended for the following personnel, who must also have knowledge of electrical systems (an electrical engineer or the equivalent).

- Personnel in charge of installing FA systems.
- Personnel in charge of designing FA systems.
- Personnel in charge of managing FA systems and facilities.

## ***General Precautions***

The user must operate the product according to the performance specifications described in the operation manuals.

Before using the product under conditions which are not described in the manual or applying the product to nuclear control systems, railroad systems, aviation systems, vehicles, combustion systems, medical equipment, amusement machines, safety equipment, and other systems, machines, and equipment that may have a serious influence on lives and property if used improperly, consult your OMRON representative.

Make sure that the ratings and performance characteristics of the product are sufficient for the systems, machines, and equipment, and be sure to provide the systems, machines, and equipment with double safety mechanisms.

This manual provides information for programming and operating the Unit. Be sure to read this manual before attempting to use the Unit and keep this manual close at hand for reference during operation.

 **WARNING** It is extremely important that a PC and all PC Units be used for the specified purpose and under the specified conditions, especially in applications that can directly or indirectly affect human life. You must consult with your OMRON representative before applying a PC System to the above-mentioned applications.

## ***Safety Precautions***

### **General Warnings**

 **WARNING** Do not attempt to disassemble the Unit while power is being supplied. Doing so may result in electrical shock.

















 **WARNING** Do not touch any of the terminals while power is being supplied. Doing so may result in electrical shock.











 **WARNING** Take safety measures outside the Cam Positioner to ensure safety for the entire system in the event of Cam Positioner failure or error caused by external factors of the Cam Positioner.

Faulty operations may result in serious accidents.

- Emergency stop circuits, interlock circuits, limit circuits, and similar safety measures must be included in control circuits outside the Cam Positioner.
- The Cam Positioner turns OFF all outputs when its self-diagnostic function detects an error (ERROR is OFF), when TRIG input turns ON, or when RESET input turns ON. Take safety measures outside the Cam Positioner to ensure safety for the entire system in such an event.
- The Cam Positioner output may remain ON or OFF due to damage to an output transistor or for some other reason. Take safety measures outside the Cam Positioner to ensure safety for the entire system in such an event.

## General Precautions

-  **Caution** Fail-safe measures must be taken by the customer to ensure safety in the event of incorrect, missing, or abnormal signals caused by broken signal lines, momentary power interruptions, or other causes.
-  **Caution** Always use the power supply voltages specified in the operation manuals.
-  **Caution** Take appropriate measures to ensure that the specified power with the rated voltage and frequency is supplied. Be particularly careful in locations where the power supply is unstable.
-  **Caution** Install external breakers and take other safety measures against short-circuiting in external wiring.
-  **Caution** Disconnect the functional ground terminal from the protective ground terminal when performing insulation resistance or withstand voltage tests
-  **Caution** Always connect to a ground of 100  $\Omega$  or less when installing the Unit.
-  **Caution** Do not attempt to disassemble, repair, or modify the Unit.
-  **Caution** Leave the label attached to the Unit when wiring.
-  **Caution** Remove the label after the completion of wiring to ensure proper heat dissipation.
-  **Caution** Use crimp terminals for wiring. Do not connect bare stranded wires directly to terminals.
-  **Caution** Thoroughly check all wiring before turning ON the power supply.
-  **Caution** Wire all connections correctly.
-  **Caution** Do not place objects on top of the cables or other wiring lines.
-  **Caution** Do not pull on the cables or bend the cables beyond their natural limit.
-  **Caution** Before touching a Unit, be sure to first touch a grounded metallic object in order to discharge any static built-up.
-  **Caution** Be sure that all the mounting screws, terminal screws, and cable connector screws are tightened to the torque specified in the operation manual. For DIN track mounting, push the Cam Positioner forward until the lock snaps into place.

-  **Caution** Be sure that cables and other items with locking devices are properly locked into place.
-  **Caution** Always turn OFF the power supply to the Unit before attempting any of the following.
- Assembling the Unit.
  - Setting switches.
  - Connecting cables or wiring the system.
  - Connecting or disconnecting the connectors.
-  **Caution** Thoroughly check the newly created cam programs, parameter settings, and switch settings for proper execution before actually running them.
-  **Caution** Confirm that no adverse effect will occur in the system before attempting any of the following.
- Switching the operating mode of the Unit
  - Origin compensation
  - Switching the execution bank
-  **Caution** When installing the Unit, adjust the origin before starting operation.
-  **Caution** Be sure that the number of resolver rotations is always within the allowable range.
-  **Caution** When replacing the Unit, transfer all the parameters and cam programs from the old Unit to the new Unit before restarting operation.
-  **Caution** Do not apply voltages to the input terminal in excess of the rated input voltage.
-  **Caution** Do not apply voltages or connect loads to the output terminal or cam output connector in excess of the maximum switching capacity.
-  **Caution** Do not touch the terminals for one minute after the power is turned OFF.

## Installation Precautions

 **Caution** Install the Unit properly as specified in the operation manual.

 **Caution** Do not install the Unit in the following locations.

- Locations subject to direct sunlight.
- Locations subject to temperatures or humidity outside the range specified in the specifications.
- Locations subject to condensation as the result of severe changes in temperature.
- Locations subject to corrosive or flammable gases.
- Locations subject to dust (especially iron dust) or salts.
- Locations subject to exposure to water, oil, or chemicals.
- Locations subject to shock or vibration.

 **Caution** Take appropriate and sufficient countermeasures when installing the Unit in the following locations.

- Locations subject to static electricity or other forms of noise.
- Locations subject to strong electromagnetic fields and magnetic fields.
- Locations subject to possible exposure to radioactivity.
- Locations close to power supplies.

## Conformance to EC Directives

### ■ Applicable Directives

- EMC Directives
- Low Voltage Directive

### Concepts

#### EMC Directives

EMC Directives stipulate that the system must comply with both EMS and EMI standards (see the following note). Because OMRON devices are designed for installation in various equipment or machines, they comply with the relevant EMC standards so that the equipment or machines can easily comply with the EMC standards. However, the systems used by customers are diverse, and EMC-related performance of the OMRON devices that comply with EC Directives will vary depending on the configuration, wiring, and other conditions of the equipment or control panel in which the OMRON devices are installed. The customer must, therefore, perform final checks to confirm that devices and the overall machine conform to EMC standards.

**Note** Applicable EMC (Electromagnetic Compatibility) standards are as follows:

EMS (Electromagnetic Susceptibility):	EN61131-2
EMI (Electromagnetic Interference):	EN61000-6-4
	(Radiated emission: 10-m regulations)

#### Low Voltage Directive

Always ensure that devices operating at voltages of 50 to 1,000 V AC or 75 to 1,500 V DC meet the required safety standards (EN61131-2).

## **Conformance to EC Directives**

The 3F88L-160/162 Cam Positioner complies with EC Directives. To ensure that the system in which the 3F88L-160/162 is installed complies with EC Directives, the following precautions must be observed.

1. The 3F88L-160/162 is defined as an in-panel device according to the Low-voltage Directive. The 3F88L-160/162 must, therefore, be installed within a control panel.
2. Reinforced insulation or double insulation must be used for the DC power supplies used as I/O power supplies.
3. The 3F88L-160/162 conforms to the Common Emission Standard (EN61000-6-4) in relation to EMI. However, the radiated emission (10-m regulations) may vary depending on the configuration of the control panel, connected devices, wiring, and other conditions. The user must, therefore, confirm that devices and the overall machinery conform to EC Directives.



# ***Terms and Conditions Agreement***

## ***Warranty, Limitations of Liability***

### **Warranties**

- **Exclusive Warranty** Omron's exclusive warranty is that the Products will be free from defects in materials and workmanship for a period of twelve months from the date of sale by Omron (or such other period expressed in writing by Omron). Omron disclaims all other warranties, express or implied.
- **Limitations** OMRON MAKES NO WARRANTY OR REPRESENTATION, EXPRESS OR IMPLIED, ABOUT NON-INFRINGEMENT, MERCHANTABILITY OR FITNESS FOR A PARTICULAR PURPOSE OF THE PRODUCTS. BUYER ACKNOWLEDGES THAT IT ALONE HAS DETERMINED THAT THE PRODUCTS WILL SUITABLY MEET THE REQUIREMENTS OF THEIR INTENDED USE.  

Omron further disclaims all warranties and responsibility of any type for claims or expenses based on infringement by the Products or otherwise of any intellectual property right.
- **Buyer Remedy** Omron's sole obligation hereunder shall be, at Omron's election, to (i) replace (in the form originally shipped with Buyer responsible for labor charges for removal or replacement thereof) the non-complying Product, (ii) repair the non-complying Product, or (iii) repay or credit Buyer an amount equal to the purchase price of the non-complying Product; provided that in no event shall Omron be responsible for warranty, repair, indemnity or any other claims or expenses regarding the Products unless Omron's analysis confirms that the Products were properly handled, stored, installed and maintained and not subject to contamination, abuse, misuse or inappropriate modification. Return of any Products by Buyer must be approved in writing by Omron before shipment. Omron Companies shall not be liable for the suitability or unsuitability or the results from the use of Products in combination with any electrical or electronic components, circuits, system assemblies or any other materials or substances or environments. Any advice, recommendations or information given orally or in writing, are not to be construed as an amendment or addition to the above warranty.

See <http://www.omron.com/global/> or contact your Omron representative for published information.

### **Limitation on Liability; Etc**

OMRON COMPANIES SHALL NOT BE LIABLE FOR SPECIAL, INDIRECT, INCIDENTAL, OR CONSEQUENTIAL DAMAGES, LOSS OF PROFITS OR PRODUCTION OR COMMERCIAL LOSS IN ANY WAY CONNECTED WITH THE PRODUCTS, WHETHER SUCH CLAIM IS BASED IN CONTRACT, WARRANTY, NEGLIGENCE OR STRICT LIABILITY.

Further, in no event shall liability of Omron Companies exceed the individual price of the Product on which liability is asserted.

# ***Application Considerations***

## **Suitability of Use**

Omron Companies shall not be responsible for conformity with any standards, codes or regulations which apply to the combination of the Product in the Buyer's application or use of the Product. At Buyer's request, Omron will provide applicable third party certification documents identifying ratings and limitations of use which apply to the Product. This information by itself is not sufficient for a complete determination of the suitability of the Product in combination with the end product, machine, system, or other application or use. Buyer shall be solely responsible for determining appropriateness of the particular Product with respect to Buyer's application, product or system. Buyer shall take application responsibility in all cases.

NEVER USE THE PRODUCT FOR AN APPLICATION INVOLVING SERIOUS RISK TO LIFE OR PROPERTY WITHOUT ENSURING THAT THE SYSTEM AS A WHOLE HAS BEEN DESIGNED TO ADDRESS THE RISKS, AND THAT THE OMRON PRODUCT(S) IS PROPERLY RATED AND INSTALLED FOR THE INTENDED USE WITHIN THE OVERALL EQUIPMENT OR SYSTEM.

## **Programmable Products**

Omron Companies shall not be responsible for the user's programming of a programmable Product, or any consequence thereof.

# ***Disclaimers***

## **Performance Data**

Data presented in Omron Company websites, catalogs and other materials is provided as a guide for the user in determining suitability and does not constitute a warranty. It may represent the result of Omron's test conditions, and the user must correlate it to actual application requirements. Actual performance is subject to the Omron's Warranty and Limitations of Liability.

## **Change in Specifications**

Product specifications and accessories may be changed at any time based on improvements and other reasons. It is our practice to change part numbers when published ratings or features are changed, or when significant construction changes are made. However, some specifications of the Product may be changed without any notice. When in doubt, special part numbers may be assigned to fix or establish key specifications for your application. Please consult with your Omron's representative at any time to confirm actual specifications of purchased Product.

## **Errors and Omissions**

Information presented by Omron Companies has been checked and is believed to be accurate; however, no responsibility is assumed for clerical, typographical or proofreading errors or omissions.

**OMRON**

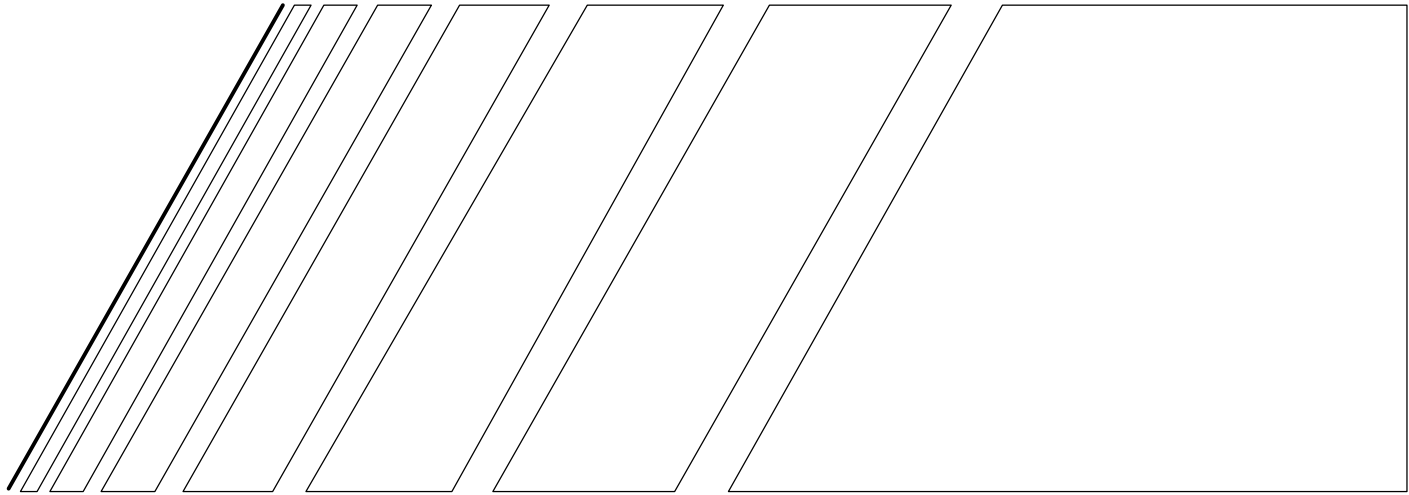

# **USER'S MANUAL**

**3F88L-160/162 Cam Positioner**

# Table of Contents

## **Chapter 1. Outline . . . . . 1-1**

1-1	Functions . . . . .	1-2
1-1-1	Basic Operation . . . . .	1-2
1-1-2	Resolution . . . . .	1-2
1-1-3	Modes . . . . .	1-3
1-1-4	Selecting the Function Level . . . . .	1-3
1-1-5	Basic Functions . . . . .	1-3
1-1-6	Initial Settings Functions . . . . .	1-4
1-1-7	Applied Functions . . . . .	1-4
1-2	System Configuration . . . . .	1-6
1-3	Name and Function of Each Part . . . . .	1-7
1-3-1	Display Section . . . . .	1-8
1-3-2	Switches . . . . .	1-8
1-3-3	Operation Keys . . . . .	1-9
1-3-4	Terminal Block and Connectors . . . . .	1-9
1-4	Glossary . . . . .	1-10
1-5	Operation Procedure . . . . .	1-11
1-5-1	Before Operation . . . . .	1-11

## **Chapter 2. Design . . . . . 2-1**

2-1	System Design . . . . .	2-2
2-1-1	Selecting the Resolver . . . . .	2-2
2-1-2	Selecting the Output Device . . . . .	2-4
2-2	Installation . . . . .	2-6
2-2-1	External Dimensions . . . . .	2-6
2-2-2	Installation Environment . . . . .	2-8
2-2-3	Mounting the Resolver . . . . .	2-9
2-3	Wiring . . . . .	2-13
2-3-1	System Connection Diagram . . . . .	2-13
2-3-2	Standard Wiring Method . . . . .	2-14
2-3-3	Terminal Block Wiring . . . . .	2-16
2-3-4	Resolver Wiring . . . . .	2-21
2-3-5	Cam Output Wiring . . . . .	2-22
2-3-6	Connecting a Display Unit . . . . .	2-25

## **Chapter 3. Operation . . . . . 3-1**

3-1	Nomenclature of Display and Operation Sections . . . . .	3-2
3-2	Modes, Functions, and Display . . . . .	3-4
3-3	Operation Procedure . . . . .	3-12
3-3-1	Before Operation . . . . .	3-12
3-4	Selecting Function Levels . . . . .	3-14
3-5	Basic Operation . . . . .	3-20
3-5-1	Function Level Selection Setting (SET Mode) . . . . .	3-20
3-5-2	Initial Settings . . . . .	3-21
3-5-3	Cam Program Creating and Checking (PRGM Mode/SET Mode) . . . . .	3-24
3-5-4	Resolver and Machinery Connection . . . . .	3-37
3-5-5	Origin Compensation . . . . .	3-37
3-5-6	Start Operation (RUN Mode) . . . . .	3-38
3-5-7	I/O Monitor Function (RUN Mode) . . . . .	3-40
3-5-8	Control I/O Signals . . . . .	3-42

# Table of Contents

3-6	Applied Functions	3-44
3-6-1	Function Level Selection Setting (SET Mode)	3-44
3-6-2	Parameter List (SET Mode)	3-45
3-6-3	Parameter Explanation and Operation	3-49
3-6-4	Origin Compensation and Origin Shift	3-56
3-6-5	Backlash Compensation	3-60
3-6-6	Advance Angle Compensation	3-62
3-6-7	Cam Protect	3-69
3-6-8	One-direction Function	3-75
3-6-9	Output Hold Function	3-77
3-6-10	Present Value Output Function	3-78
3-6-11	Pulse Output Function	3-80
3-6-12	Teaching	3-83
3-6-13	Copy Function (Data Transfer)	3-88
3-6-14	Trial/Adjustment Operation	3-93

## **Chapter 4. Communications** . . . . . **4-1**

4-1	Overview of CompoWay/F Communications	4-2
4-2	Command and Response Frames	4-5
4-2-1	Command Frame	4-5
4-2-2	Response Frame	4-7
4-3	Command Types	4-10
4-3-1	Memory Area Read (RUN)	4-10
4-3-2	Parameter Area Read/Write (SET)	4-12
4-3-3	Controller Data Read (RUN, PRGM, SET)	4-19
4-3-4	Unit Attribute Read (RUN, PRGM, SET)	4-20
4-3-5	Controller Status Read (RUN, PRGM, SET)	4-20
4-3-6	Operation Command (RUN)	4-21
4-3-7	Internode Echo Test (RUN, PRGM, SET)	4-22
4-4	Executing CompoWay/F Commands with Protocol Macros	4-23

## **Chapter 5. Operation** . . . . . **5-1**

5-1	Diagnosis using Error Codes	5-2
5-2	CompoWay/F Communications Errors	5-7
5-3	Troubleshooting	5-9
5-4	Inspection and Maintenance	5-12
5-5	Cam Positioner Replacement	5-13

## **Chapter 6. Specifications** . . . . . **6-1**

6-1	Cam Positioner Specifications	6-2
6-2	Resolver Specifications	6-4
6-3	I/O Block Specifications	6-6
6-4	Display Specifications	6-8

## **Chapter 7. Appendix** . . . . . **7-1**

7-1	Application Examples	7-2
7-2	Performance	7-4
7-3	Resolver Life Expectancy	7-8
7-4	Standard Models	7-11

# Table of Contents

---

7-5	Displays by Mode .....	7-12
7-6	Error Codes .....	7-16
7-7	Cam Programming Sheet .....	7-21
7-8	Parameter Settings Log Chart .....	7-22
<b>Index</b>	.....	<b>I-1</b>
<b>Revision History</b>	.....	<b>R-1</b>

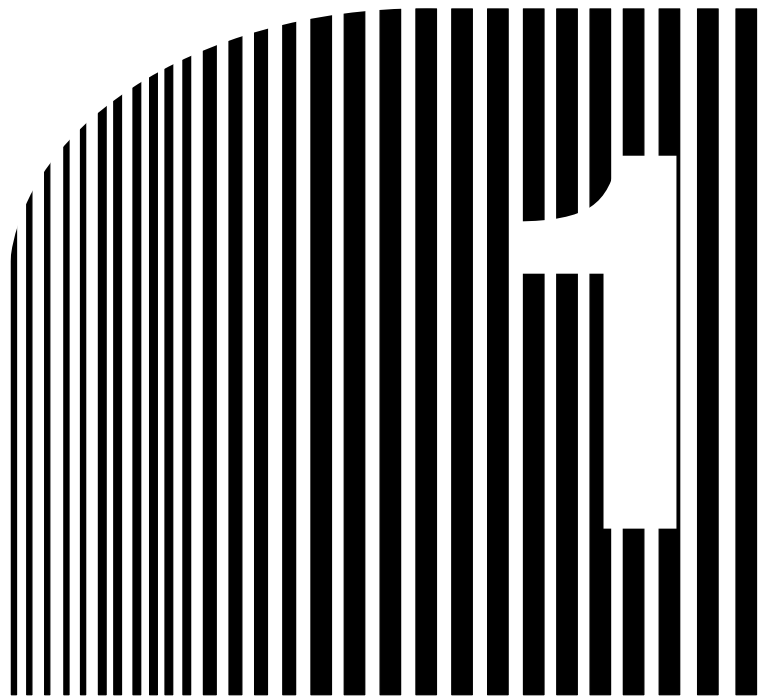

# Chapter 1

## • Outline •

- 1-1 Functions
- 1-2 System Configuration
- 1-3 Name and Function of Each Part
- 1-4 Glossary
- 1-5 Operation Procedure

## 1-1 Functions

The 3F88-L160 and 3F88L-162 Cam Positioners are Units that detect angles through a Resolver (a sensor that detects absolute angles) and turn output signals ON and OFF at a preset angle through a cam program.

The 3F88L-160 Cam Positioner has 16 cam output points and the 3F88L-162 Cam Positioner has 32 cam output points.

### 1-1-1 Basic Operation

- Input a cam program (the ON/OFF pattern for cam outputs) into the Cam Positioner, use the bank switching signal to select the bank number, and turn ON the operation signal to start operation.

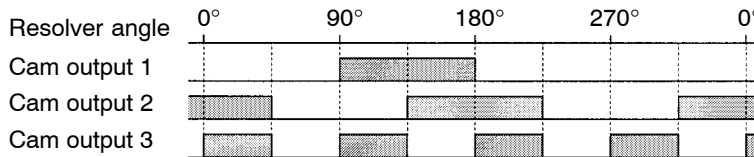

(Programming example for 360 resolution)

Cam Program (Bank No. 1)			
Cam No.	Step	ON angle	OFF angle
1	1	90	180
2	1	315	45
2	2	135	225
3	1	0	45
---	---	---	---

Cam Program (Bank No. 2)			
---	---	---	---

Cam Program (Bank No. 3)			
---	---	---	---

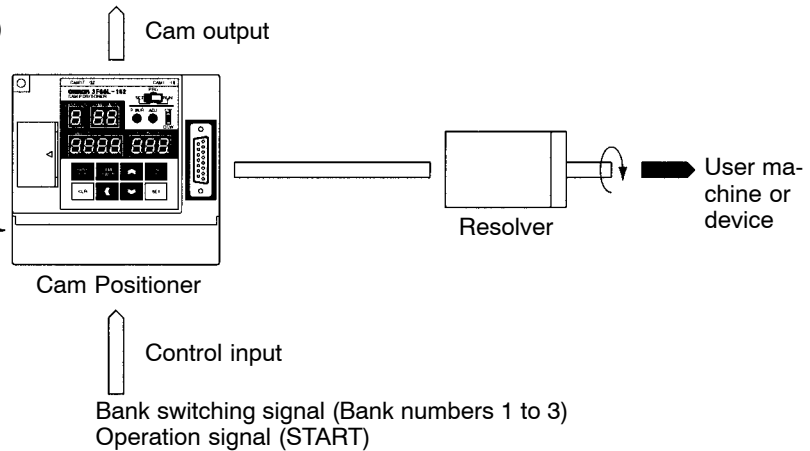

### 1-1-2 Resolution

- The angle resolution can be set to 360 (divisions/revolution) or 720 (divisions/revolution).
- The following table shows how functions and performances are affected by resolution settings.

Function or Characteristic	360 resolution	720 resolution
Angle setting and display units	1° is set and displayed as "1."	0.5° is set and displayed as "1."
Permissible Resolver speed	1,600 r/min	800 r/min
No. of cam program steps	180 max.	360 max.
Number of banks	8	4

**Note** For example, to set the ON angle at 90°, the setting is "90" for a 360 resolution and "180" for a 720 resolution.



### 1-1-3 Modes

- The 3F88-L160 and 3F88L-162 Cam Positioners have three modes: RUN, PRGM, and SET. These are set using the mode selection switch on the front of the Unit. The functions of each mode are outlined below. (Refer to *3-2 Mode, Functions, and Display*.)

RUN mode: Operation and compensation.

PRGM mode: Creation, editing, deletion, and trial operation of cam programs.

SET mode: Unit parameters and various compensation value settings, teaching, and communications settings.

### 1-1-4 Selecting the Function Level

- Three function levels are available to limit Cam Positioner functions. (Refer to *3-4 Selecting Function Levels*.)

Function Level 0 (Monitor Only)

Cam output and monitoring are enabled. Cam programs are write protected and parameter settings cannot be made. This function level is designed to prevent inadvertent changes to the cam program or parameters.

Function Level 1 (Basic Operation/Monitor Only)

In addition to the functions available at function level 0, cam programs may be edited. This function level is used for basic operation.

Function Level 2 (All Functions)

All Cam Positioner functions are enabled. This function level is for using applied functions.

### 1-1-5 Basic Functions

#### ■ Cam Program Write Function

- Cam programs set the angle at which the cam output is turned ON and OFF. Up to 180 steps can be set and up to 8 banks registered for 360 resolution and up to 360 steps and 4 banks for 720 resolution can be set for each cam output point. (Refer to *3-5-3 Cam Program Creating and Checking*.)
- Cam programs are normally input by using the operation keys on the front of the Unit but settings can be made from a personal computer by using a special communications protocol (CompoWay/F). (Refer to *Chapter 4 Communications*.)

**Note 1.** A step is one ON/OFF combination for one cam.

**Note 2.** A bank is a program unit made up of cam outputs 1 to 32 for the 3F88L-162 and cam outputs 1 to 16 for the 3F88L-160. By changing the bank, the program that will be operated will change.

#### ■ Cam Output

- While START input is ON, this function turns cam outputs ON and OFF in the bank specified at BANK input according to the ON/OFF angles set for each cam.

#### ■ Monitor

- Monitors cam output and control I/O status. (Refer to *3-5-7 I/O Monitor Function*.)

## ■ Data Save

- Saves parameters and cam programs in non-volatile memory (EEPROM). As the data is stored in non-volatile memory, battery replacement, and other maintenance is not required.

## ■ Program Number Check

- The number of programs and origin compensation angle can be checked. (Refer to *3-5-3 Cam Program Creating and Checking.*)

## 1-1-6 Initial Settings Functions

### ■ Switching Resolution

- Switches between 360 and 720 divisions per Resolver revolution. (Refer to *3-5-2 Initial Settings.*)

### ■ Changing Rotation Direction

- Sets the direction of increasing angle to suit the mechanical configuration. (Refer to *3-5-2 Initial Settings.*)

## 1-1-7 Applied Functions

### ■ Origin Compensation

- Sets any angle to 0° according to the mechanical origin. (Refer to *3-6-4 Origin Compensation and Origin Shift.*)

### ■ Origin Shift

- Sets any angle to 0° according to the mechanical origin when the trigger turns ON in RUN mode. (Refer to *3-6-4 Origin Compensation and Origin Shift.*)

### ■ Backlash Compensation

- Sets a difference between the detection angles in CW and CCW directions to absorb mechanical vibration. (Refer to *3-6-5 Backlash Compensation.*)

### ■ Advance Angle Compensation

- Advances the cam output angle in proportion to the number of Resolver revolutions. (Refer to *3-6-6 Advance Angle Compensation.*)

### ■ Cam Protect

- Protects each bank and cam to prevent the cam ON/OFF data being inadvertently changed or deleted.

### ■ One-direction Function Setting

- Enables cam output in one rotational direction only. (Refer to *3-6-8 One-direction Function.*)

## ■ Output Hold Function

- Holds the immediately preceding cam output status when the user switches to PRGM mode or when there is an error. (Refer to *3-6-9 Output Hold Function*.)

## ■ Present Value Output Function

- Uses the cam output signal and outputs the signal to the Display Unit (M7E, M7F, or other Display Units.) The present angle or number of revolutions can be displayed on the Display Unit. (Refer to *3-6-10 Present Value Output Function*.)

## ■ Pulse Output Function

- Automatically sets data that turns ON and OFF at regular intervals in a desired bank or cam in order to edit memory contents. (Refer to *3-6-11 Pulse Output Function*.)

## ■ Teaching

- The Resolver angle data may be input as cam program settings during manual operation of the machinery. (Refer to *3-6-12 Teaching*.)

## ■ Copy Function

- By making the settings for one Cam Positioner, the cam program, the various compensation values, and settings in one operation may be copied to another Cam Positioner.

## ■ Trial Operation

- When adjusting the ON/OFF angles to suit the machinery, performs cam output and changes the ON/OFF angle in real time regardless of the control input signal status. (Refer to *3-6-14 Trial/Adjustment Operation*.)

## ■ Compensation Operation

- When adjusting the ON/OFF angles to suit the machinery, changes the ON/OFF angles in real time while in operation status (cam output status). (Refer to *3-6-14 Trial/Adjustment Operation*.)

## ■ Communications Function

- Has a communications port that conforms to shape B in CompoWay/F. Communications can be used to read and write cam programs and monitor present angles and number of revolutions. (Refer to *Chapter 4 Communications*.)

**Note** CompoWay/F is a uniform procedure in OMRON serial communications. CompoWay/F has uniform frame formats and commands that conform to FINS (Factory Interface Network Service) that is used in OMRON PCs. It facilitates easier communications between multiple components and between personal computers and components.

# 1-2 System Configuration

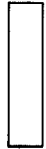
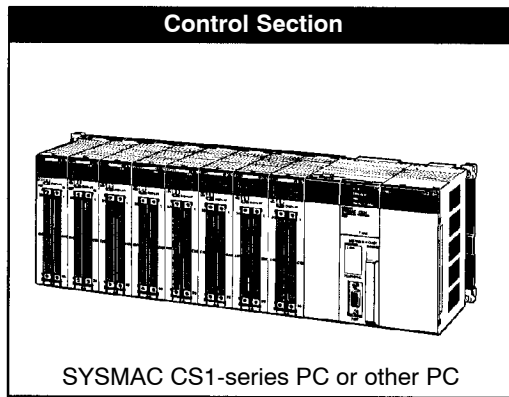

Control I/O signal

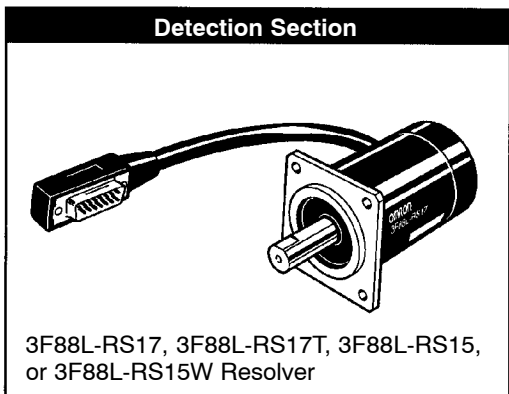
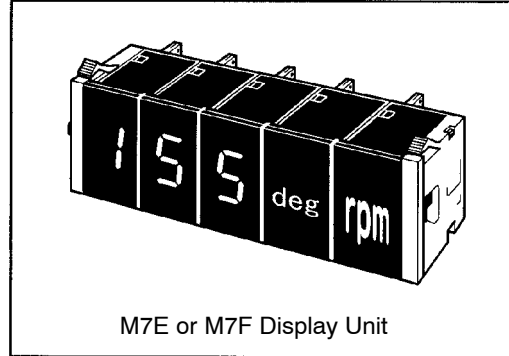
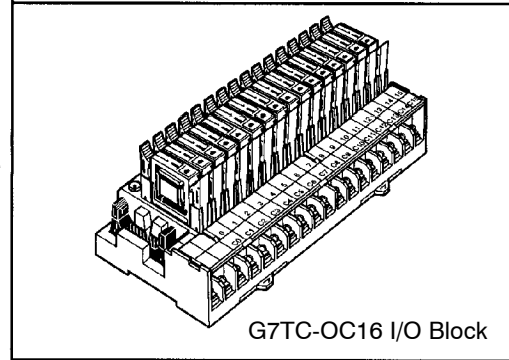
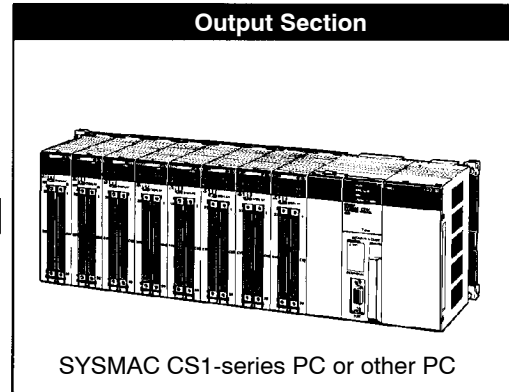
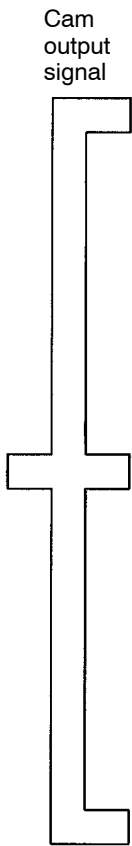
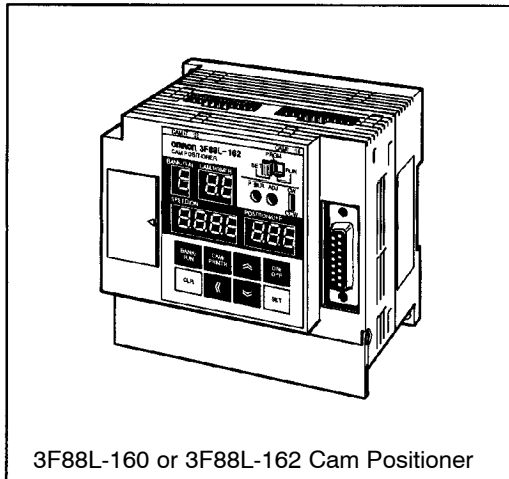

**Note** Refer to 2-3 Wiring or 7-4 Standard Models for information on various connection cables.

### 1-3 Name and Function of Each Part

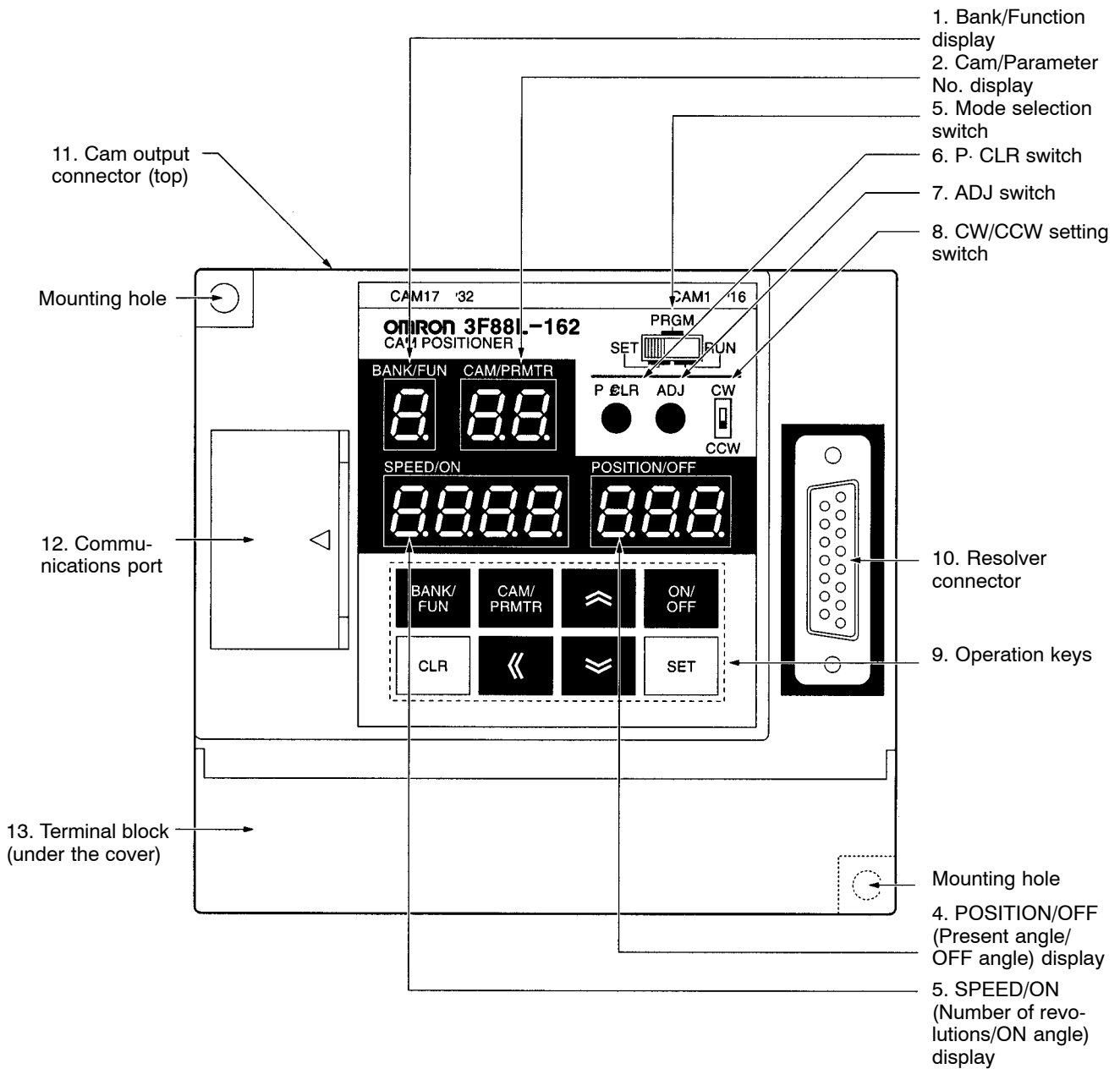

### 1-3-1 Display Section









- Displays the operation status, error status, and settings data.
- The data displayed will differ depending on the mode.

Name	Mode	Display
1. Bank and function display	RUN	Display the number of the operating bank.
	PRGM	Display the number of the bank being programmed.
	SET	Display the number of the function being set.
2. Cam and parameter number display	RUN	Displays "ru" when the START signal is ON and is blank when the START signal is OFF.
	PRGM	Displays the number of the cam being programmed.
	SET	(Different for different settings functions.)
3. Number of revolutions and ON angle display	RUN	Displays the number of revolutions or an error message.
	PRGM	Displays the ON angle or an error message.
	SET	(Differs for different settings functions.)
4. Present angle and OFF angle display	RUN	Displays the present angle.
	PRGM	Displays the OFF angle.
	SET	(Different for different settings functions.)

### 1-3-2 Switches

Name	Mode	Function
5. Mode selection switch	---	Switches between the three operation modes: RUN, PRGM, and SET.
6. P · CLR switch	PRGM	Deletes all cam programs in the Cam Positioner.
7. ADJ switch	SET	Adjusts the compensation by executing origin compensation.
8. CW/CCW setting switch	When power is turned ON	Changes the rotation direction. The direction of increasing angle is set to either CW (clockwise) or CCW (counterclockwise) when viewed from the Resolver axle side.

### 1-3-3 Operation Keys

	Name	Mode	Function
	Bank/Function Key	PRGM/SET	Increases bank and function numbers.
	Cam/Parameter Key	---	Increases cam and parameter numbers.
	ON/OFF Switching Key	---	Switches between ON and OFF angles.
	Up Key	---	Increases the numeral that is flashing.
	Down Key	---	Decreases the numeral that is flashing.
	Forward Key	---	Changes the digit of the numeral to be set.
	Clear Key	---	Clears data.
	Set Key	---	Saves input data.

### 1-3-4 Terminal Block and Connectors

Name	Function
10. Resolver connector	Connects to the Resolver cable connector.
11. Cam output connector	Used for cam output.
12. Communications port	CompoWay/F communications connector (connects to a personal computer and other Cam Positioners) (9-pin D-sub connector)
13. Terminal block	Power input, control input, and control output terminals.

---

**1-4 Glossary**

---

Term	Meaning
Cam output	Cam output consists ON/OFF outputs for the Resolver angle according to the ON/OFF angles set by the user (the cam program).
Cam program	A cam program consists ON/OFF angle data set by the user.
Cam protect	The cam data protect function protects the cam ON/OFF data from being inadvertently changed or deleted.
Compensation operation	When in RUN mode, this function can be used to adjust the cam output ON and OFF angles by using the operation keys in order to check mechanical operation.
Origin compensation	When in SET mode, the mechanical origin and the Resolver origin can be aligned by pressing the ADJ switch on the front of the Cam Positioner.
Origin shift	When in RUN mode, this function can be used to temporarily shift the displayed angle to the origin by shorting the TRIG terminal with the 0-V terminal.
Origin value	The origin value is a value set as the origin of the Resolver. This value can be set to any angle when origin compensation or origin shift has been performed. The default setting is 0.
Resolver	The Resolver is a sensor that detects the absolute angle. One of four Resolver models (3F88L-RS17, 3F88L-RS17T, 3F88L-RS15, and 3F88L-RS15W) can be selected for 3F88L-160 and 3F88L-162 Cam Positioners.
Trial operation	<p>When in PRGM mode, this function can be used to adjust the cam output ON and OFF angles by using the operation keys in order to check mechanical operation.</p> <p>The greatest difference from compensation operation is the ability to adjust the ON and OFF angles of any bank or cam number without any external control signal input during trial operation.</p>



## 1-5 Operation Procedure

### 1-5-1 Before Operation

#### ■ Basic Use

- The procedure for using the Cam Positioner at function level 1 (basic operation/monitor only) is outlined below.

Procedure	Contents	Reference section
Installation	Install the Cam Positioner according to the installation environment conditions.	2-2
Wiring	Connect the wiring for the power supply, Resolver, and peripheral devices.	2-3
Power ON	<p><b>Before the power is turned ON:</b></p> <ul style="list-style-type: none"> <li>• Check that the wires and connectors for the Resolver and peripheral devices have been connected properly.</li> <li>• Check that the Resolver and the machinery are not connected.</li> </ul> <p><b>After the power is turned ON:</b></p> <ul style="list-style-type: none"> <li>• Check that there are no error codes displayed (E-**).</li> <li>• Set the mode selection switch to RUN and check that the number of revolutions and the present angle display changes when the Resolver axis is rotated by hand.</li> </ul>	
Function level selection	Select function level 1 (basic operation/monitor only).	3-5-1
Initial settings	Set the resolution (SET mode) and rotation direction (CW/CCW) to suit the application.	3-5-2
Power resetting (OFF to ON)	Turn ON the power to enable the set parameters.	
Creation and confirmation of cam programs	Create and check cam programs (PRGM mode). Check the number of programs (SET mode).	3-5-3
Connection between Resolver and machinery	Turn OFF the power and connect the Resolver and the machinery.	3-5-4
Execution of origin compensation	Turn ON the power and execute origin compensation (use the ADJ switch in SET mode).	3-5-5
Operation/monitoring	Change to RUN mode and check the operation of the machinery and monitor the I/O status. Correct the cam program if required (PRGM mode).	3-5-6
Function level selection	If required, set to function level 0 (monitor only) to prevent faulty operation.	3-4

**Note** This procedure is applicable when only the basic functions (function level 1) are used. In the cases outlined below, the applied functions (function level 2) must be used. (Refer to 3-6 *Applied Functions*.)

- When setting origin compensation values, using backlash compensation, advance angle compensation, and other compensation functions.
- When executing a trial or compensation operation.

- When using the teaching function.
- When making pulse output, cam data protect, output hold, one-direction function, and present value output settings.

■ **Applied Functions**

• The procedure for using the Cam Positioner at function level 2 (all functions) is outlined below.

Procedure	Contents	Reference section
Installation	Install the Cam Positioner according to the installation environment conditions.	2-2
Wiring	Connect the wiring for the power supply, Resolver, and peripheral devices.	2-3
Power ON	<p><b>Before the power is turned ON:</b></p> <ul style="list-style-type: none"> <li>• Check that the wires and connectors for the Resolver and peripheral devices have been connected properly.</li> <li>• Check that the Resolver and the machinery are not connected.</li> </ul> <p><b>After the power is turned ON:</b></p> <ul style="list-style-type: none"> <li>• Check that there are no error codes displayed (E-**).</li> <li>• Set the mode selection switch to RUN and check that the number of revolutions and the present angle display changes when the Resolver axis is rotated by hand.</li> </ul>	
Function level selection	Select function level 2 (all functions).	3-6-1
Initial settings	Set the resolution (SET mode) and rotation direction (CW/CCW) to suit the application.	3-5-2
Power resetting (OFF to ON)	Turn ON the power to enable the set parameters.	
Parameter settings	Make the parameter settings.	3-6-2 and 3-6-3
Power resetting (OFF to ON)	Turn ON the power to enable the set parameters.	
Creation and confirmation of cam programs	Create and check cam programs (PRGM mode). Check the number of programs (SET mode).	3-5-3
Connection between Resolver and machinery	Turn OFF the power and connect the Resolver and the machinery.	3-5-4
Execution of origin compensation	Turn ON the power and execute origin compensation (use the ADJ switch in SET mode).	3-5-5
Teaching	If required, use the teaching function (SET mode) and create a cam program while operating the machinery manually.	3-6-12
Trial operation	Change to PRGM mode, and, if required, adjust the cam program while checking the timing of the cam output.	3-6-14
Operation/monitoring	Change to RUN mode and check the operation of the machinery and monitor the I/O status. Correct the cam program if required (PRGM mode).	3-5-6
Origin shift execution	If required, turn ON TRIG input and execute origin shift (RUN mode).	3-6-4
Compensation operation	If required, adjust the cam program while checking the timing of the cam output.	3-6-14
Function level selection	If required, set to function level 0 (monitor only) to prevent faulty operation.	3-4

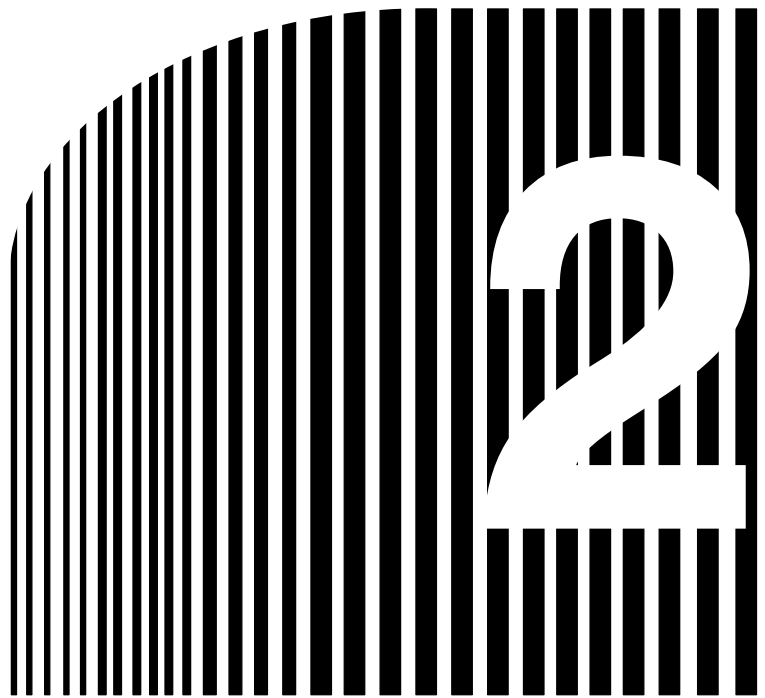

## Chapter 2

### • Design •

- 2-1 System Design
- 2-2 Installation
- 2-3 Wiring

## 2-1 System Design

**⚠ WARNING** Take safety measures outside the Cam Positioner to ensure safety for the entire system in the event of Cam Positioner failure or error caused by factors external to the Cam Positioner.  
Faulty operation may result in a serious accident.

- Emergency stop circuits, interlock circuits, limit circuits, and similar safety measures must be included in control circuits outside the Cam Positioner.
- The Cam Positioner turns OFF all outputs when its self-diagnostic function detects an error (ERROR is OFF), when TRIG input turns ON, or when RESET input turns ON. Take safety measures outside the Cam Positioner to ensure safety for the entire system in such an event.
- The Cam Positioner output may remain ON or OFF due to damage to an output transistor or for some other reason. Take safety measures outside the Cam Positioner to ensure safety for the entire system in such an event.

### 2-1-1 Selecting the Resolver



There are four Resolver models available. Select the Resolver suitable for the application.

#### ■ Resolvers

Type	Large-diameter	High-torque	Connector	Lead-wire
<b>Model</b>	3F88L-RS17	3F88L-RS17T	3F88L-RS15	3F88L-RS15W
<b>Axle diameter</b>	10 mm		6 mm	
<b>Rated axle load</b>	Thrust load: 196 N max. Radial load: 196 N max.		Thrust load: 98N max. Radial load: 98 N max.	
<b>Total length</b>	101 mm	110 mm	154 mm	97 mm
<b>Attachment method</b>	Flange		Connected to the servo.	
<b>Friction torque</b>	12 mN • m max.	49 to 147 mN • m	2.9 mN • m max.	
<b>Connection to Cam Positioner</b>	Shown in diagram A.		Shown in diagram B.	Shown in diagram C.

**Note** High-torque Resolvers have oil seals.

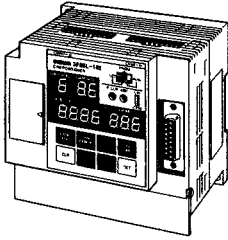
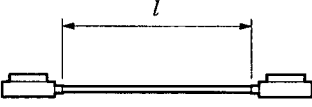
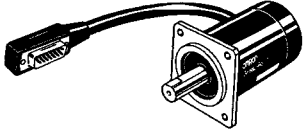
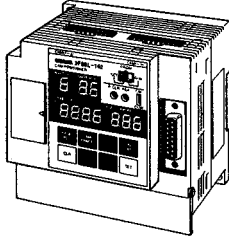
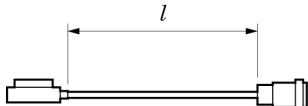
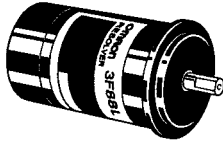
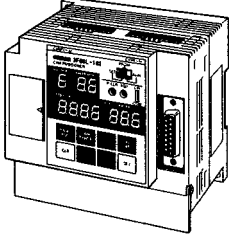
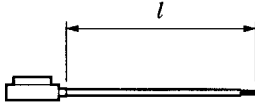
■ Cam Positioner and Resolver Configuration

<p>A</p>	 <p>3F88L-160 or 3F88L-162 Cam Positioner</p>	 <p>3F88L-CR□□□C Resolver Extension Cable</p>	<p>3-m Plug-in cable</p>  <p>3F88L-RS17/-RS17T Resolver</p>
<p>B</p>	 <p>3F88L-160 or 3F88L-162 Cam Positioner</p>	 <p>3F88L-CR□□□NA Resolver Cable</p>	<p>Connector type</p>  <p>3F88L-RS15 Resolver</p>
<p>C</p>	 <p>3F88L-160 or 3F88L-162 Cam Positioner</p>	 <p>3F88L-CR□□□SA Resolver Cable</p>	<p>35-cm Separate wire plug-in cable</p>  <p>3F88L-RS15S Resolver</p>

**Note 1.** 3F88-RS17 and 3F88-RS17T Resolvers have 3-m cables. Use the 3F88L-CR□□□C Resolver Extension Cable if more cable is required.

**Note 2.** The □□□ in the Extension Cable model number indicates the length of the Extension Cable. For example, the 3F88L-CR010C Extension Cable is 10 m in length.

**Note 3.** The distance between the Cam Positioner and the Resolver can be up to 100 m.

## 2-1-2 Selecting the Output Device

Select the device and connection method for ON/OFF outputs from the Cam Positioner. (Refer to 2-3 *Wiring* for information on connecting output devices.)

### ■ For Relay Output

Use an I/O Block for relay output.

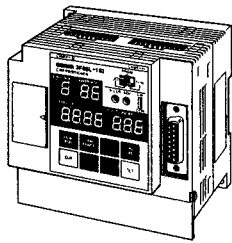

3F88L-160 or 3F88L-162  
Cam Positioner

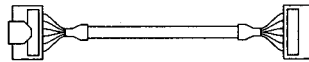

3F88L-CG□□□N  
Cam Output Cable

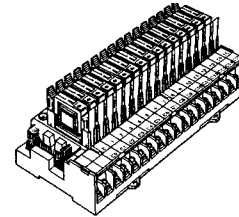

G7TC-OC16  
I/O Block

### ■ For Transistor (Open Collector) Output

Use the outputs straight from the Cam Output Cable.

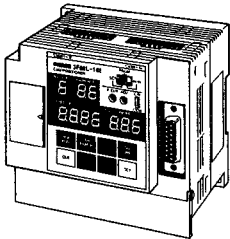

3F88L-160 or 3F88L-162  
Cam Positioner

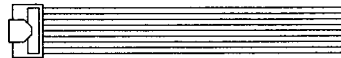

3F88L-CG□□□S  
Cam Output Cable

Open collector output

### ■ For Mostly Relay Output with Some Open Collector Output

Use an I/O Block and use an Output Short-circuit Module to give some open collector output.

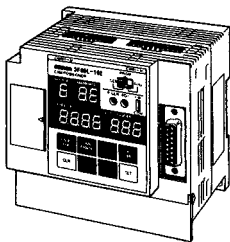

3F88L-160 or 3F88L-162  
Cam Positioner

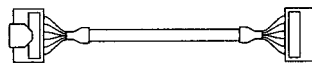

3F88L-CG□□□N  
Cam Output Cable

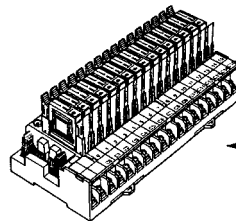

G7TC-OC16  
I/O Block

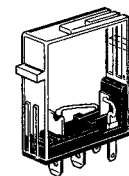

Output  
Short-circuit  
Module

■ To Display Present Angles and Other Data on a Display Unit

Connect a M7E or M7F Display Unit to the Cam Output Cable.

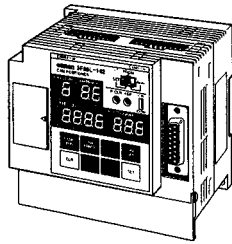

3F88L-160 or 3F88L-162  
Cam Positioner

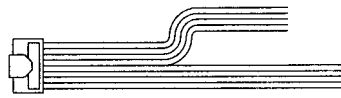

3F88L-CG□□□S  
Cam Output Cable

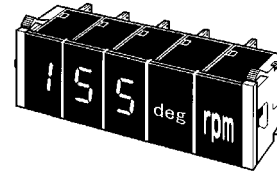

M7E or M7F Display Unit

**Note** Parameters must be set to output present values. The present value output and cam output terminals will be shared which means that some cam output signals can no longer be used.

## 2-2 Installation

### 2-2-1 External Dimensions

Note All units are in millimeters unless otherwise indicated.

#### ■ 3F88L-160 and 3F88L-162 Cam Positioners

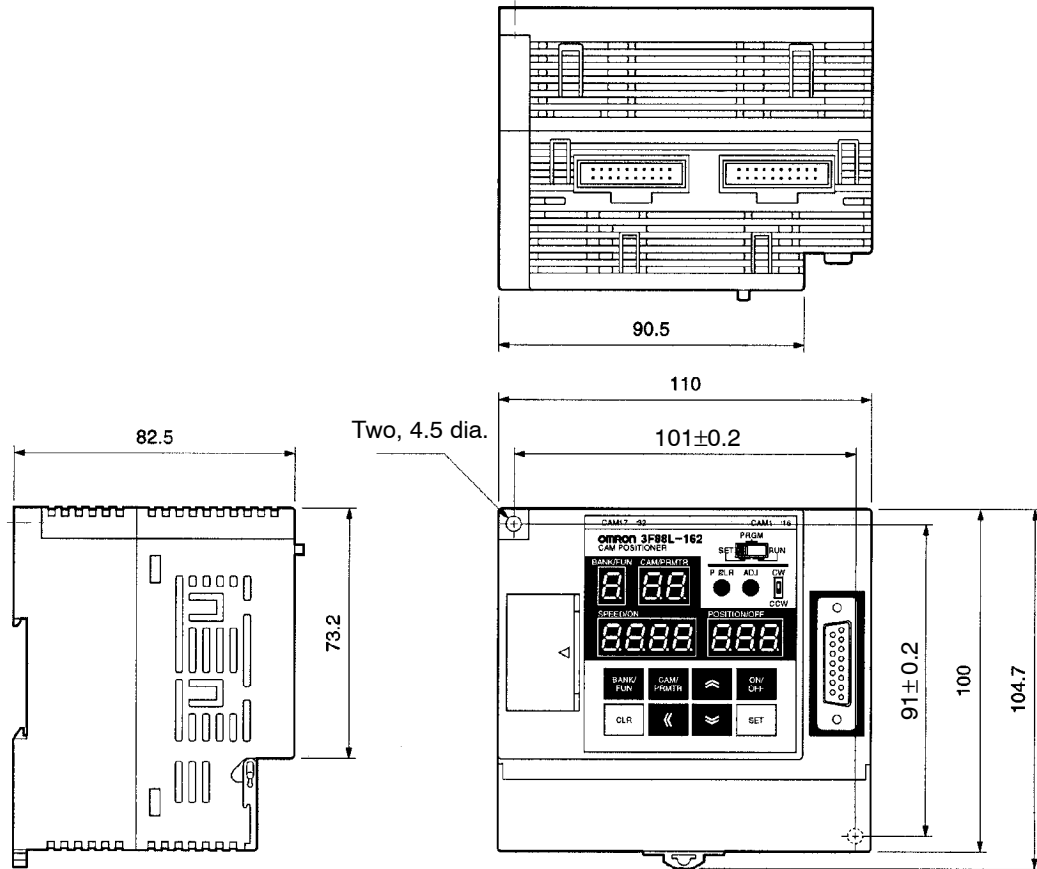

- When the Resolver Cable is connected

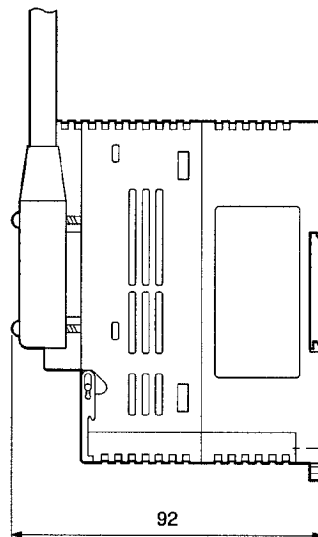



■ Resolvers

● 3F88L-RS17 and 3F88L-RS17T

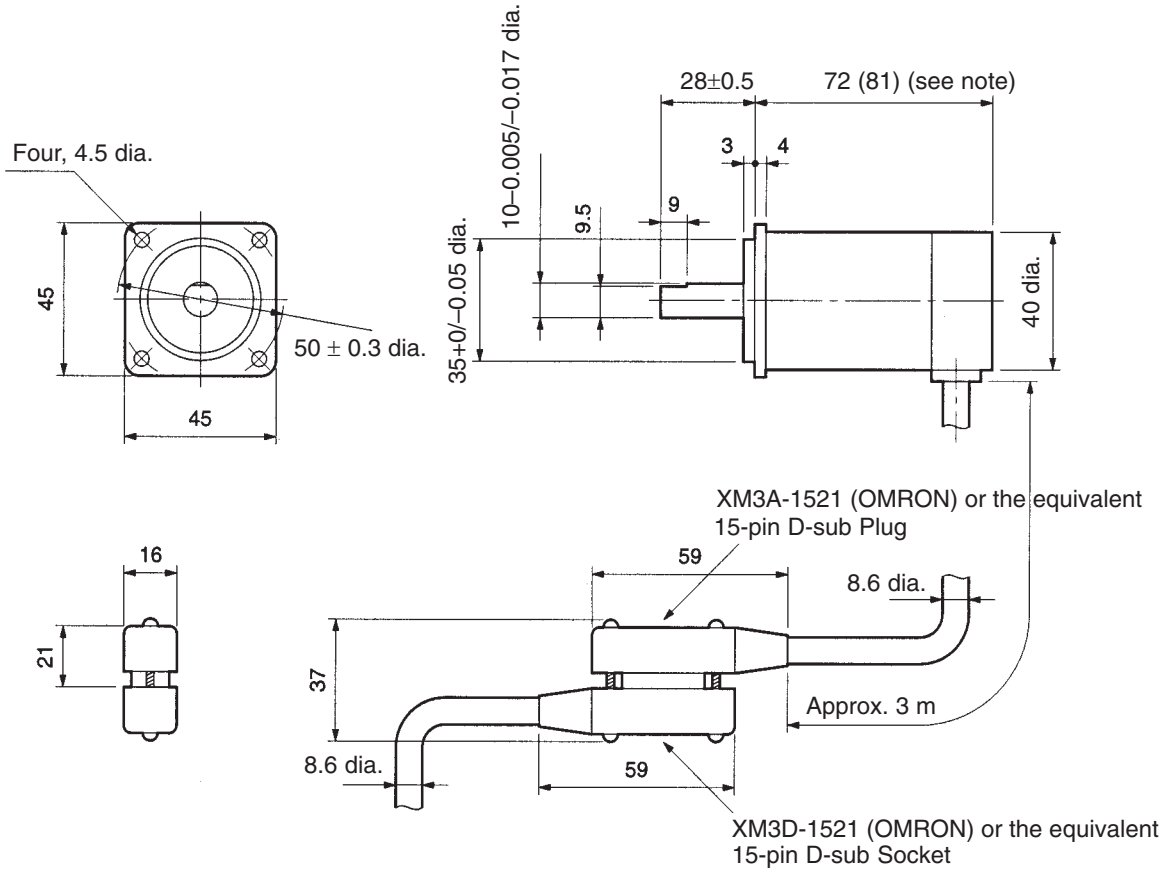

**Note** The dimensions in parentheses are for the 3F88L-RS17T Resolver.

● 3F88L-RS15

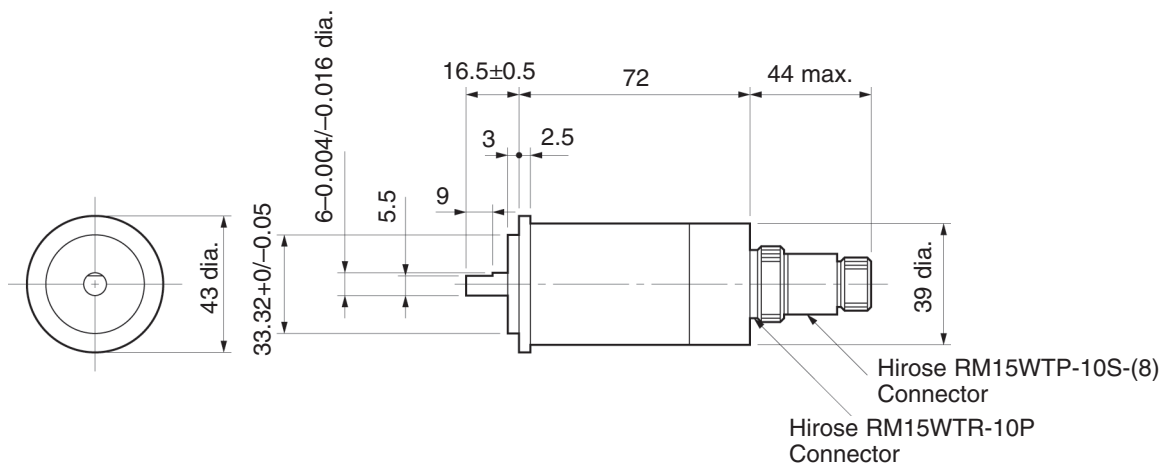

● 3F88L-RS15W

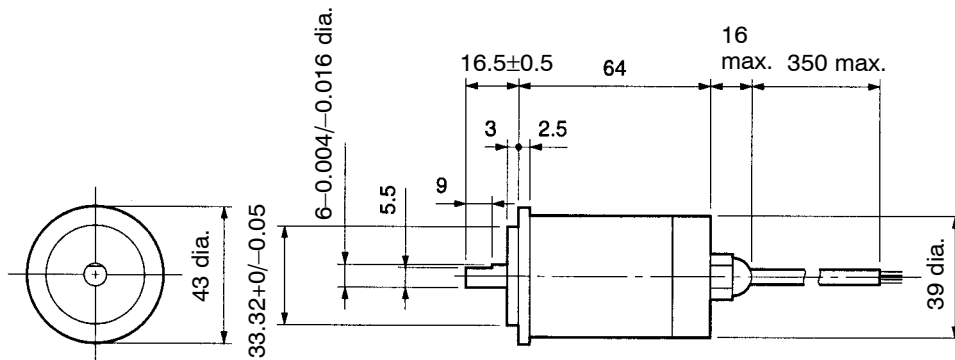

## 2-2-2 Installation Environment

---

Take precautions with the installation environment to improve the reliability and to fully utilize the functions of the Cam Positioner system.

---

### ■ Do not install the Unit in the following locations.

- Locations subject to direct sunlight.
- Locations subject to ambient temperatures or relative humidities outside the following ranges.  
Ambient temperature: 0° to 55°C (Cam Positioner Unit) and -10° to 80°C (Resolver)  
Ambient humidity: 10 to 90 % (with no condensation).
- Locations subject to condensation as the result of severe changes in temperature.
- Locations subject to corrosive or flammable gases.
- Locations subject to dust (especially iron dust) or salts.
- Locations subject to exposure to water, oil, or chemicals.
- Locations subject to shock or vibration.

### ■ Take appropriate and sufficient countermeasures when installing the Unit in the following locations.

- Locations subject to static electricity or other forms of noise.
- Locations subject to strong electromagnetic fields and magnetic fields.
- Locations subject to possible exposure to radioactivity.
- Locations close to power supplies.

■ **Conformance to EC Directives**

The 3F88L-160/162 Cam Positioner complies with EC Directives. To ensure that the system in which the 3F88L-160/162 is installed complies with EC Directives, the following precautions must be observed.

- The 3F88L-160/162 is defined as an in-panel device according to the Low-voltage Directive. The 3F88L-160/162 must, therefore, be installed within a control panel.
- Reinforced insulation or double insulation must be used for the DC power supplies used as I/O power supplies.
- The 3F88L-160/162 conforms to the Common Emission Standard (EN50081-2) in relation to EMI. However, the radiated emission (10-m regulations) may vary depending on the configuration of the control panel, connected devices, wiring, and other conditions. The customer must, therefore, confirm that devices and the overall machine conform to EC Directives.

**2-2-3 Mounting the Resolver**

---



---

Use the Resolver Coupling to connect the Resolver to the machinery. This Coupling protects the Resolver from vibrations and shocks from the machinery.

---



---

■ **Mounting Method**

● **3F88L-RS17/17T (Flange-mounted)**

• **Recommended mounting holes**

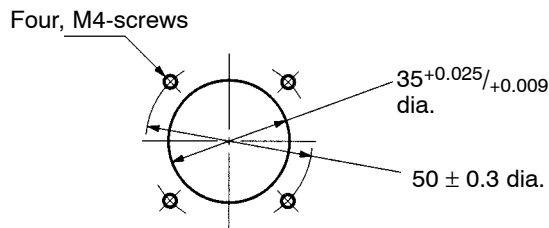

• **Mounting example**

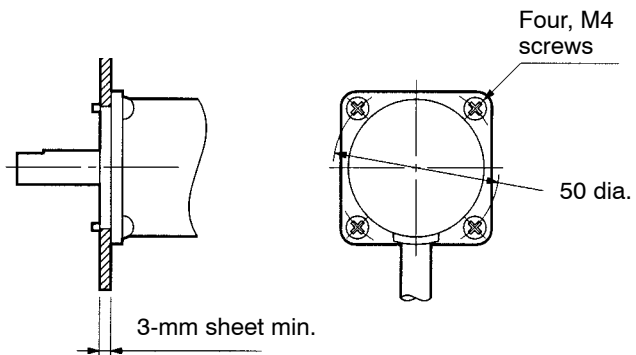

● 3F88L-RS15/15W (Servo-mounted)

• Recommended mounting hole

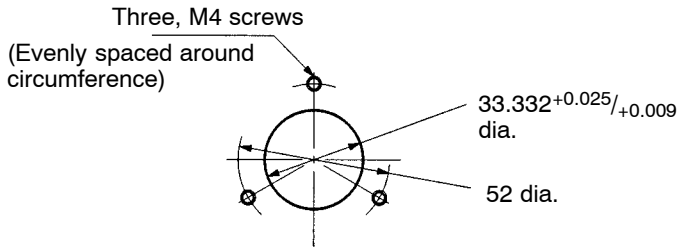

• Mounting example

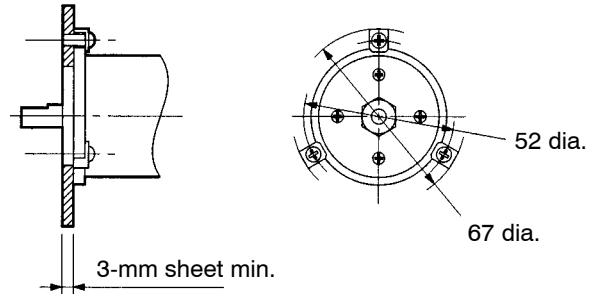

• Mounting hook (Resolver attachment)

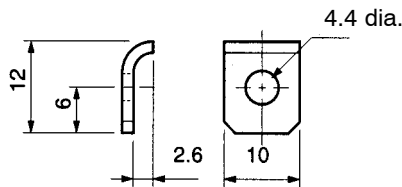

■ Connecting with the Coupling

As a rule, the Resolver Coupling should be used when connecting the Resolver to the machinery. The Coupling will break near the center if 1.7 to 2 times the rated tightening torque is applied and, therefore, protects the Resolver from excessive torque.

Keep the axle center displacement and bend angle of the Coupling within the specifications when mounting.

● Coupling Specifications

3F88L-Couplings	3F88L-Resolvers	Dimensions (mm)							Max. bend angle $\theta_1$ (see note 2)	Axle center displacement t1 (see note 3)	Rated tightening torque		Screw sets	
		D dia.	E dia.	L	P	A	B	C			+20°C	+80°C	Size	Tightening torque
RL10	RS17/RS17J	10	22	26.2	19	3.6	7.1	12	10° max.	1.0 mm max.	2.94 N • m	1.76 N • m	M4 × 6	0.44 N • m
RL6	RS15/RS15W	6	15	22	16.4	2.8	5.5	11	10° max.	1.2 mm max.	0.98 N • m	0.58 N • m	M3 × 4	0.24 N • m

**Note 1.** The Coupling is made from 25% Duracon glass fiber.

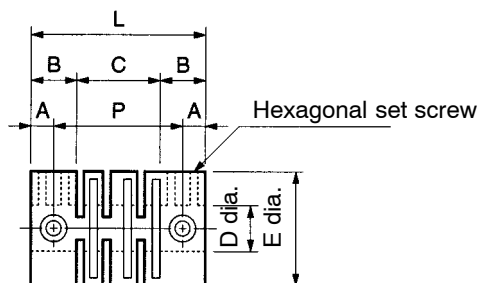

**Note 2.** Maximum bend angle

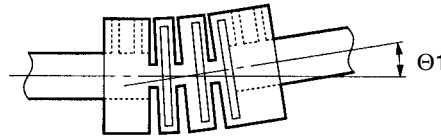

**Note 3.** Axle center displacement

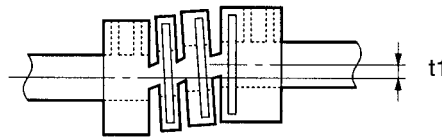

**● Precautions when Connecting with the Coupling**

Take the following precautions when connecting the Resolver to the machinery via the Coupling.

- Make sure the axle center does not protrude into the area marked C in the diagram. If the axle center is protruding when the Resolver rotates, the Coupling will no longer function and the machinery may be damaged.
- If the bend angle or displacement of the axle center is large, the life of the Coupling will be shortened and the accuracy of the Resolver rotation angle will be adversely affected.

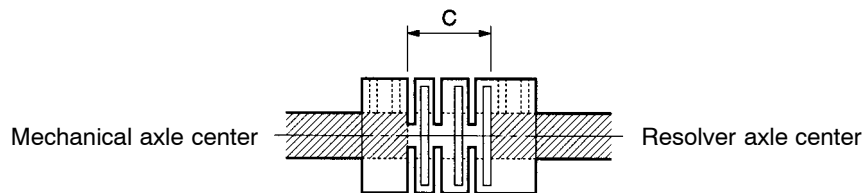

**■ Connecting without the Coupling**

Give sufficient consideration to the load that will be applied to the Resolver axle if it is connected to the machinery without the Coupling. Make sure the applied load will be below the rated load.

**● Rated Resolver Axle Load**

Model	3F88L-RS17	3F88L-RS17T	3F88L-RS15	3F88L-RS15W
<b>Rated axle load</b>	Thrust load: 196 N max. Radial load: 196 N max.		Thrust load: 98 N max. Radial load: 98 N max.	

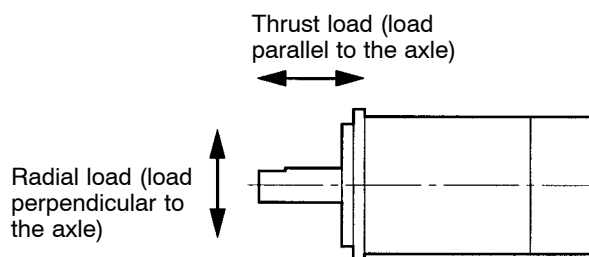

● Connection Examples

**Using a Timing Belt**

A pulley is attached directly onto the Resolver axle and connected to a rotating machinery by a timing belt.

In this case, the load on the axle is the tension on the timing belt and the weight of the pulley.

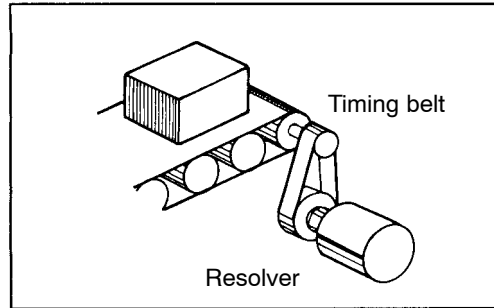

**Using Gears**

Pitch errors, total alignment errors, and other gear errors apply a repeated load in the radial direction.

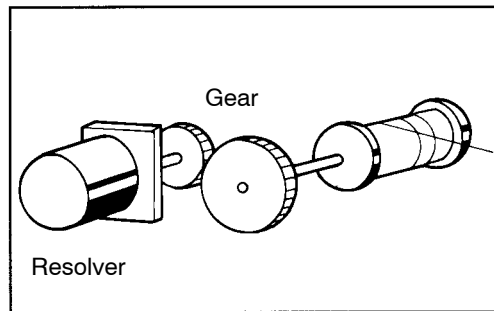

**Using Chains**

A sprocket can be attached directly to the Resolver axle and the axle then connected to a rotating machinery with a chain.

The weight of both the sprocket and the chain will be a load on the axle. Rattles in the sprocket and chain will become shock loads applied to the axle when machine movement stops and starts.

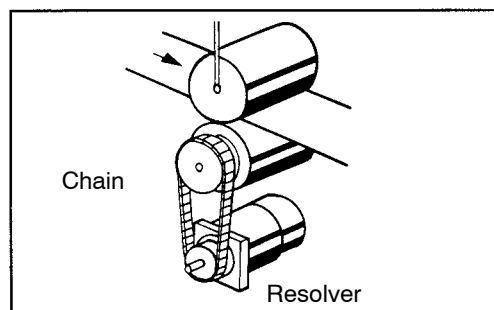

2-3 Wiring

2-3-1 System Connection Diagram

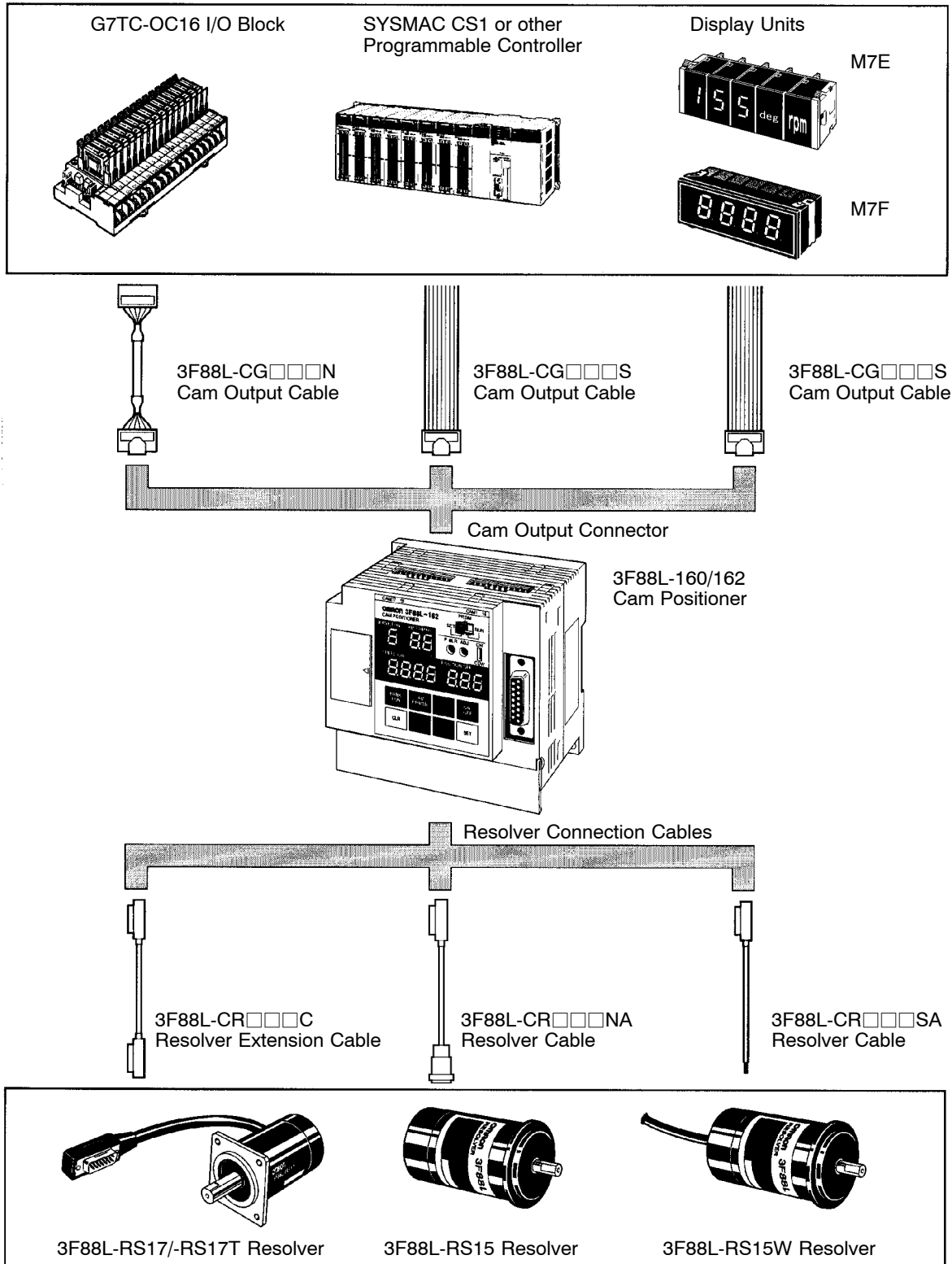

### 2-3-2 Standard Wiring Method

The number of man hours required for wiring will be reduced and the reliability of the Unit will be improved if OMRON Cables are used.  
Give sufficient consideration to noise countermeasures when wiring

#### ■ Using Connection Cables

Use the following Cables to connect the Unit to peripheral devices. Always use OMRON Cables when connecting the Resolver, in particular, to ensure reliability of the Unit.

Peripheral device to be connected	Cable name	Model	Remarks
Resolver	Resolver Cable	3F88L-CR□□□C	Extension Cable for 3F88L-RS17/-RS17T
		3F88L-CR□□□NA	Cable for 3F88L-RS15
		3F88L-CR□□□SA	Cable for 3F88L-RS15W
I/O Block	Cam Output Cable	3F88L-CG□□□N	Connectors at both ends.
PC or similar device (for cam output)	Cam Output Cable	3F88L-CG□□□S	Connector on one end.
Display Unit	Cam Output Cable	3F88L-CG□□□S	Connector on one end.

**Note** The □□□ in the cable model numbers indicates the length of the cable. Refer to 7-4 Standard Models for details.

#### ■ Wiring for Improved Noise Resistance

The noise resistance of the system can be improved by the wiring method. The following points must be given attention when wiring.

##### ● Connection Method

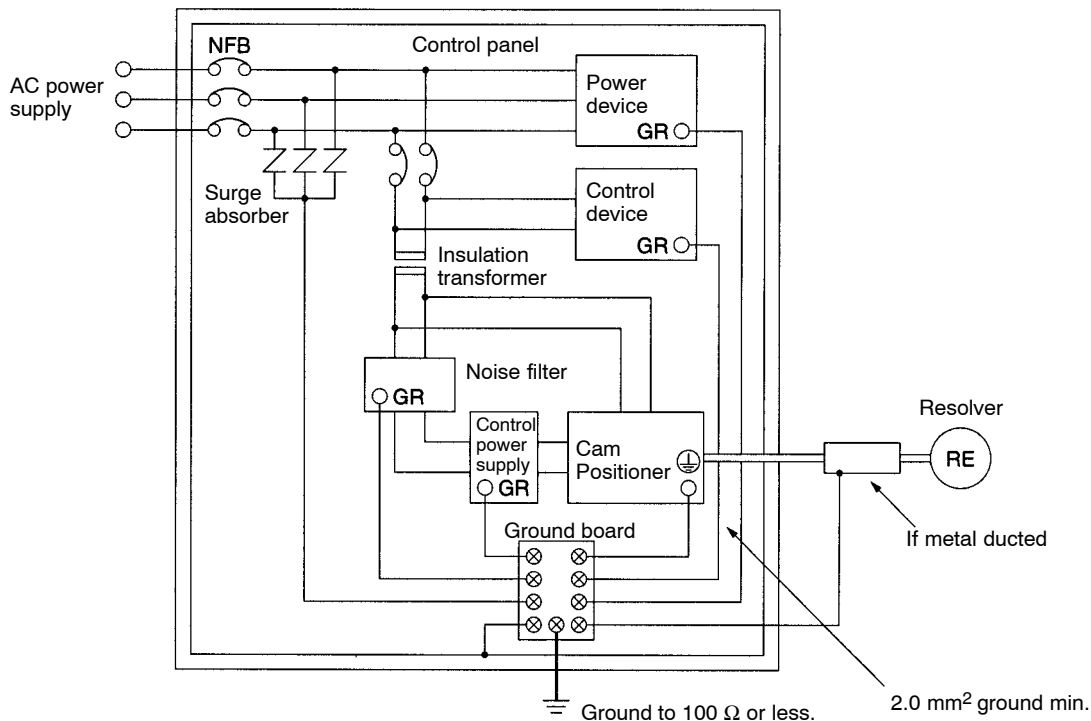



- Use a ground board as shown in the diagram and ground (FG) each Unit to one point on the ground board.
- Do not bundle the ground together with the power supply, motor drive, or Resolver signal wires or run the ground through the same duct as these wires.
- If using metal conduit or running wires through metal duct, ground the metal to one point.

**Note** To make the 3F88L-160/162 Cam Positioner conform to EC Directives, be sure to install the Unit within a control panel.

● **External Wiring**

- Use a different cable for the Cam Positioner I/O and the control wire. Do not run these wires through the same cable.
- It is recommended that the Cam Positioner cables and other control and power cables are wired as shown below.
- Parallel cable racks must be a minimum of 300 mm apart.
- If multiple terminals are to be housed in one duct, shield the terminals with a grounded conductive plate.

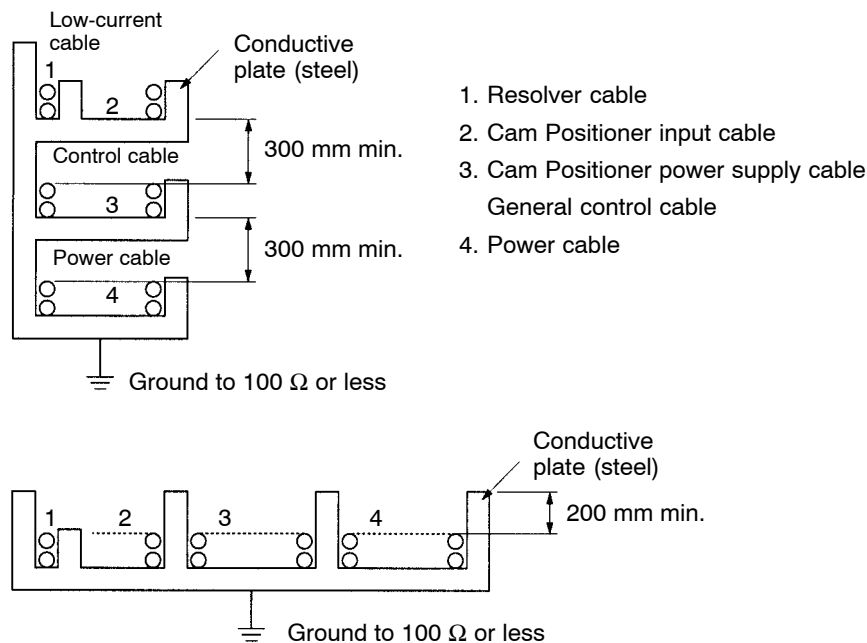

**Note** The 3F88L-160/162 conforms to the Common Emission Standard (EN50081-2) in relation to EMI. However, the radiated emission (10-m regulations) may vary depending on the configuration of the control panel, connected devices, wiring, and other conditions. The customer must, therefore, confirm that devices and the overall machine conform to EC Directives.

■ **Points to Consider when Wiring to Peripheral Devices**

- Install a surge absorber and noise filter on the AC power supply input wiring.
- Pay attention to the following points when using relays, electromagnetic valves, and other noise-generating devices.
  - Separate noise-generating devices, parts and the wiring as much as possible.
  - Use a separate power supply system.

- Use a separate grounding system.
- Attach a surge absorber or diode to the device or parts generating the noise, as shown in the following diagram.

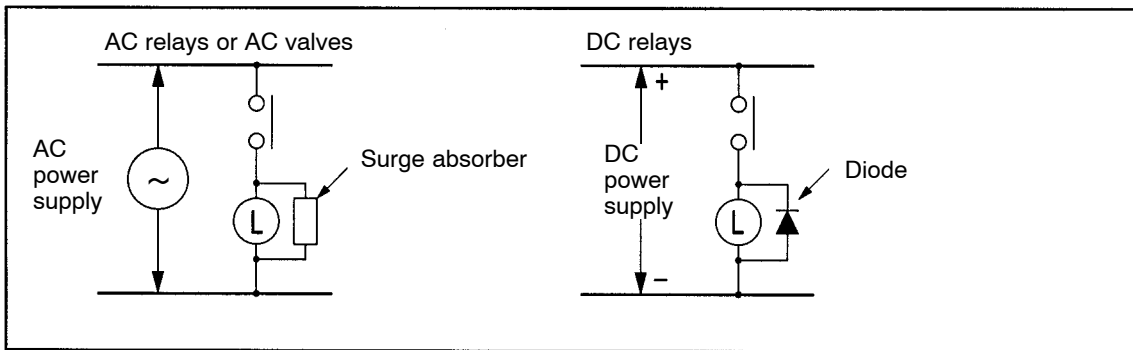

**Note** Select withstand pressure and current suitable for the load.

### 2-3-3 Terminal Block Wiring

Use crimp terminals and firmly tighten to the appropriate torque.

#### ■ Terminal Block Layout

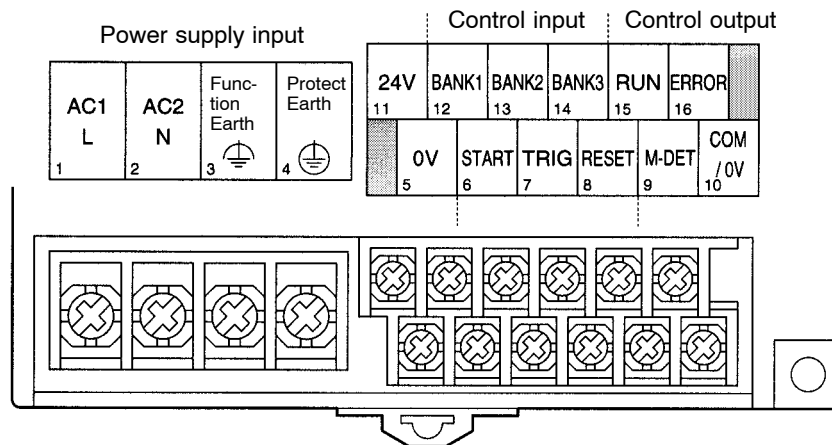

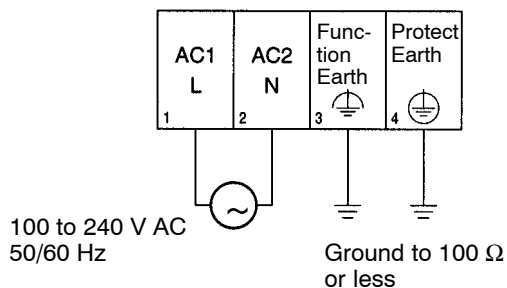

#### ■ Power Supply Input Wiring

##### • Wiring Method



Terminal screw size: M3.5  
Tightening torque: 0.8 N • m

• Terminal Functions

Terminal name	Symbol	Function	Recommended connection wire diameter
Main circuit power supply input terminal	AC1/L	Inputs the AC power supply for the Cam Positioner. Provide a 100 to 240 V AC 50/60 Hz power supply. (Rated power supply voltage 85 to 264 V AC)	1.25 mm <sup>2</sup>
	AC2/N		
Function earth terminal		This is the primary ground terminal connected for the power supply.	2.0 mm <sup>2</sup>
Protect earth terminal		This is the frame ground terminal.	2.0 mm <sup>2</sup>

**Note 1.** Use M3.5 round crimp terminals for AC 1/L and AC 2/N terminals.

**Note 2.** Use M3.5 round or forked crimp terminals for function earth and protect earth terminals.

• Round crimp terminal

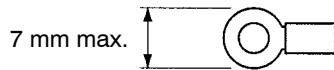

• Forked crimp terminal

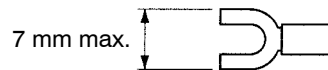

**Note** If the power supply voltage of the Cam Positioner slowly increases or decreases at less than 85% of the rated voltage (i.e., less than 85 V), operation may stop intermittently. If this affects the operation of equipment, provide protective circuits that interrupt output enough to cause the voltage to increase to more than 85% of the rated value.

■ Control Input Wiring

• Wiring Method

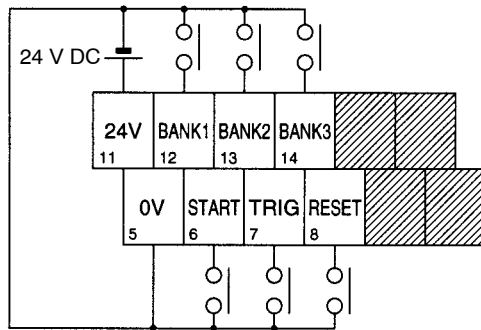

Terminal screw size: M3  
Tightening torque: 0.5 N • m

• Terminal Functions

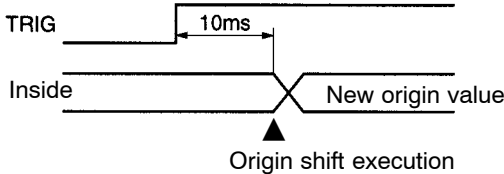
Terminal name	Symbol	Function	Recommended connection wire diameter																																				
Control I/O power supply	24 V	The control I/O power supply terminal is used for the power supply for control I/O.	1.25 mm <sup>2</sup>																																				
	0 V	Provide a 24-V DC power supply. (Rated power supply voltage 20.4 to 26.4 V DC)																																					
Operation start input	START	Cam output will start if the START signal is shorted with 0V.	0.5 mm <sup>2</sup>																																				
Bank switching input	BANK1	The BANK signals are used to select the execution bank for the Cam Positioner. The BANK signals turn ON when shorted with 0V.	0.5 mm <sup>2</sup>																																				
	BANK2	<table border="1"> <thead> <tr> <th>Bank No.</th> <th>1</th> <th>2</th> <th>3</th> <th>4</th> <th>5</th> <th>6</th> <th>7</th> <th>8</th> </tr> </thead> <tbody> <tr> <td>BANK1</td> <td>OFF</td> <td>ON</td> <td>OFF</td> <td>ON</td> <td>OFF</td> <td>ON</td> <td>OFF</td> <td>ON</td> </tr> <tr> <td>BANK2</td> <td>OFF</td> <td>OFF</td> <td>ON</td> <td>ON</td> <td>OFF</td> <td>OFF</td> <td>ON</td> <td>ON</td> </tr> <tr> <td>BANK3</td> <td>OFF</td> <td>OFF</td> <td>OFF</td> <td>OFF</td> <td>ON</td> <td>ON</td> <td>ON</td> <td>ON</td> </tr> </tbody> </table>		Bank No.	1	2	3	4	5	6	7	8	BANK1	OFF	ON	OFF	ON	OFF	ON	OFF	ON	BANK2	OFF	OFF	ON	ON	OFF	OFF	ON	ON	BANK3	OFF	OFF	OFF	OFF	ON	ON	ON	ON
	Bank No.	1		2	3	4	5	6	7	8																													
	BANK1	OFF		ON	OFF	ON	OFF	ON	OFF	ON																													
BANK2	OFF	OFF	ON	ON	OFF	OFF	ON	ON																															
BANK3	OFF	OFF	OFF	OFF	ON	ON	ON	ON																															
BANK3																																							
Origin shift input	TRIG	Origin shift is performed when this signal is shorted with 0V. <b>Note 1.</b> The TRIG signal is disabled when the Resolver rotates at 4 r/min or greater. <b>Note 2.</b> The TRIG signal is enabled when it is ON for 10 ms or more. 	0.5 mm <sup>2</sup>																																				
Reset input	RESET	If this signal is shorted with 0V, a hardware reset will be performed and the Unit will return to the state it was in upon power ON. Regardless of output-hold settings, all outputs will be turned OFF. Also, the origin value for the origin shift will be lost.	0.5 mm <sup>2</sup>																																				

**Note 1.** Use M3.5 round or forked crimp terminals for functional ground and protective ground terminals.

• Round crimp terminal

• Forked crimp terminal

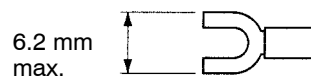
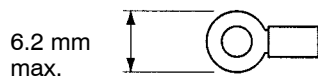

**Note 2.** Reinforced insulation or double insulation must be used for the DC power supplies used as I/O power supplies in order to comply EC Directives.

● Control Input Specifications

Item	Specification
Rated input voltage	24 V DC -15%/10%
Input impedance	4.7 kΩ
Input current	4.7 mA TYP. (for 24 V DC input)
ON voltage	17 V min. between 24-V terminal and control input terminals.
OFF voltage	5 V max. between 24-V terminal and control input terminals.
ON/OFF response time	1.0 ms
Internal circuit	

■ Control Output Wiring

● Wiring Method

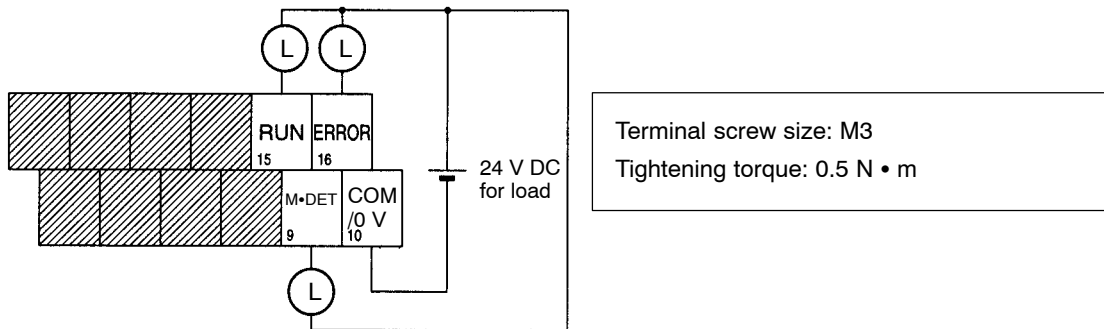

● Terminal Functions

Terminal name	Symbol	Function	Recommended connection wire diameter
Control output common terminal	COM/0 V	The COM/0 V terminal is the common terminal for control output. It is connected to the 0V terminal on the control I/O output power supply.	0.5 mm <sup>2</sup>
RUN output	RUN	The RUN terminal indicates the operation status of the Unit. It turns ON when cam output is enabled.	0.5 mm <sup>2</sup>
Resolver movement detection output	M•DET	The M•DET terminal turns ON when the Resolver is rotating at 4 r/min or faster.	0.5 mm <sup>2</sup>
Error output	ERROR	The ERROR terminal turns OFF when an error is generated.	0.5 mm <sup>2</sup>

**Note 1.** Use M3.5 round or forked crimp terminals for functional ground and protective ground terminals.

• **Round crimp terminal**



• **Forked crimp terminal**

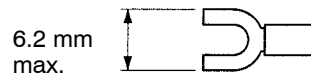

**Note 2.** Reinforced insulation or double insulation must be used for the DC power supplies used as I/O power supplies in order to comply EC Directives.

**Note 3.** The control I/O power supply must be turned ON to operate the control output circuit.

• **Control Output Specifications**

Item	Specification
Maximum switching capacity	24 V DC –15%/10%, 0.3 A/point
Leakage current	0.1 mA max.
Residual voltage	1.5 V max.
ON response time	0.5 ms max.
OFF response time	1.0 ms max.
Internal circuit	

### 2-3-4 Resolver Wiring





Use OMRON Resolver Cables which are designed to reduce noise.

Resolver Cables transfer signals that require a high degree of accuracy. Separate the Resolver Cables from other cables as much as possible to prevent the accuracy being affected by induction noise resulting from low signal voltage.

- Separate Resolver Cables as much as possible from control and drive wiring inside the control panel.
- For external wiring, house the cables in a low-current duct and shield with grounded conduction plates.

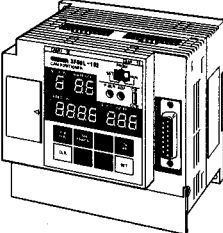
The Cam Positioner and Resolver can be separated by a maximum distance of 100 m.

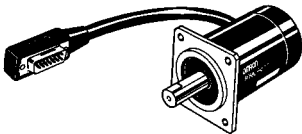
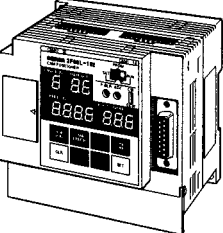
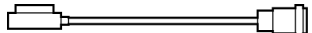
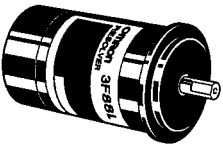
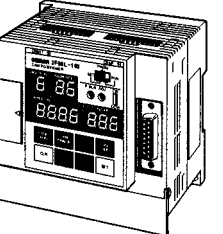
#### ■ Resolver Wiring Method

		<p>3 m plug-in cable</p> 
		<p>Connector type</p> 
		<p>35-cm Separate wire plug-in cable</p> 

● Resolver Cable Models

**Resolver Extension Cables (for 3F88L-RS17/-RS17T)**

2 m	3F88L-CR002C
5 m	3F88L-CR005C
10 m	3F88L-CR010C
20 m	3F88L-CR020C
50 m	3F88L-CR050C

**Note 1.** A maximum of two extension cables can be joined together.

**Note 2.** Refer to 6-2 *Resolver Specifications* for information on cable wire colors and pin positions.

**Resolver Cables (for 3F88L-RS15)**

3 m	3F88L-CR003NA
5 m	3F88L-CR005NA
10 m	3F88L-CR010NA
15 m	3F88L-CR015NA
20 m	3F88L-CR020NA

**Resolver Cables (for 3F88L-RS15W)**

3 m	3F88L-CR003SA
5 m	3F88L-CR005SA
10 m	3F88L-CR010SA

**2-3-5 Cam Output Wiring**

Cam output is an open-collector output. The wiring connectors are located on top of the Cam Positioner Unit and the wiring is easily performed if Cam Output Cables are used.

■ **Cam Output Wiring Method**

Use the 3F88L-CG□□□S Cam Output Cable for direct connection to PCs or Relays and the 3F88L-CG□□□N Cam Output Cable for direct connection to an I/O Block.

**Note** Cam output is also used for connection to Display Units. Refer to 2-3-6 *Connecting a Display Unit* for details.

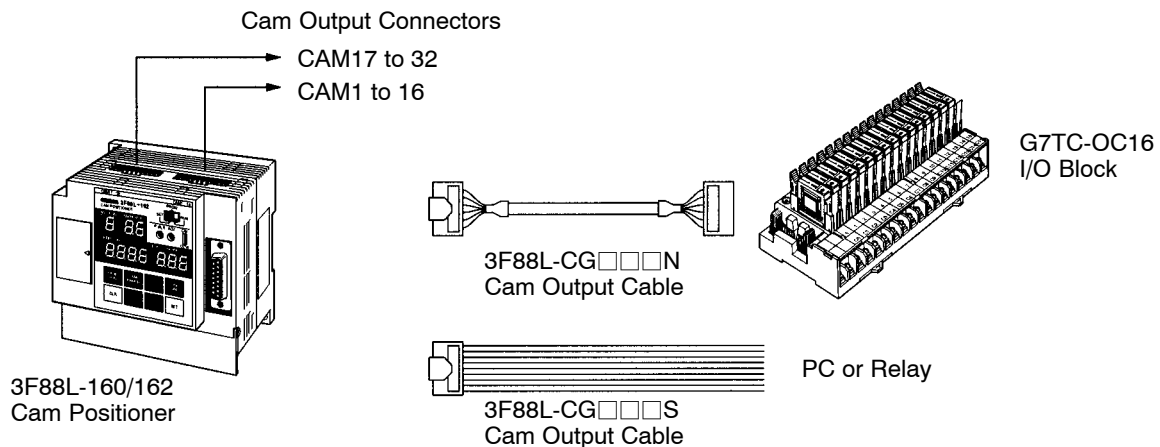



**Note** The 3F88L-160 16-output Cam Positioner does not have cam output connector terminal numbers CAM17 to CAM32.

● **Cam Output Cable Models**

**Cam Output Cables for Connection to I/O Blocks**

0.5 m	3F88L-CG0R5N
1 m	3F88L-CG001N

**Cam Output Cables for Connection to Other Devices**

1 m	3F88L-CG001S
3 m	3F88L-CG003S

■ **Cam Outputs for I/O Blocks**

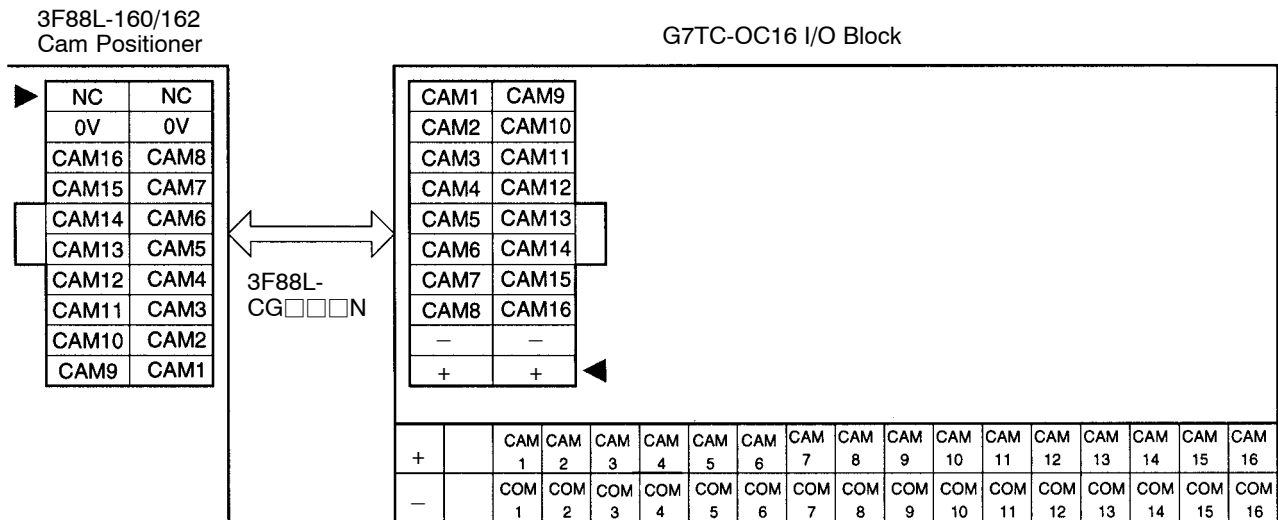

■ Cam Output Cable Connection Pin Positions and 3F88L-CG□□□S  
Cam Output Cable Colors

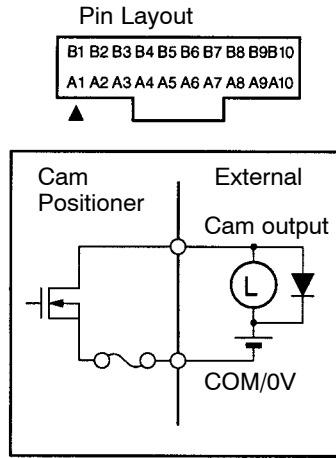

Pin No.	Signal name	Cable color	Pin No.	Signal name	Cable color
A1	NC	Brown	B1	NC	Brown
A2	COM/0V	Red	B2	COM/0V	Red
A3	CAM16 (CAM32)	Orange	B3	CAM8 (CAM24)	Orange
A4	CAM15 (CAM31)	Yellow	B4	CAM7 (CAM23)	Yellow
A5	CAM14 (CAM30)	Green	B5	CAM6 (CAM22)	Green
A6	CAM13 (CAM29)	Blue	B6	CAM5 (CAM21)	Blue
A7	CAM12 (CAM28)	Purple	B7	CAM4 (CAM20)	Purple
A8	CAM11 (CAM27)	Gray	B8	CAM3 (CAM19)	Gray
A9	CAM10 (CAM26)	White	B9	CAM2 (CAM18)	White
A10	CAM9 (CAM25)	Black	B10	CAM1 (CAM17)	Black

- Note 1.** Pin numbers have been given for convenience. The pin “A1”, indicated by the ▲ mark on the protruding side, should be used as the starting pin number.
- Note 2.** The signal names in parentheses in the table will be applicable if the Cam Connector Cable is connected to the connectors for cam outputs 17 to 32 (CAM17 to CAM32). These connectors are not available on the 3F88L-160 16-point Cam Positioner.
- Note 3.** The maximum switching capacity for cam outputs is 26.4 V DC, 300 mA. However, keep this at no more than 1.6 A per connector.
- Note 4.** The COM/0V connector is common to both A2 and B2 pins.
- Note 5.** If the present value output function is used, some cam outputs cannot be used.
- Note 6.** Reinforced insulation or double insulation must be used for the DC power supplies used as I/O power supplies in order to comply EC Directives.

■ Cam Output Specifications

Item	Specifications
Maximum switching capacity	24 V DC -15%/10%, 0.3 A/point, 1.6 A/connector
Leakage current	0.1 mA max.
Residual voltage	1.5 V max.
ON response time	0.05 ms max.
Off response time	0.07 ms max.
Internal circuit	

2-3-6 Connecting a Display Unit

If the Cam Positioner is connected to a Display Unit, the present angle and Resolver speed can be displayed.

The Display Unit is connected to the cam output connectors on the Unit via Cam Output Cables.

**Note 1.** The speed display can have an error margin of 5 r/min max.

**Note 2.** Parameters must be set to display present values such as the present angle and Resolver speed. The present value output and cam output share terminals. Some cam output signals can no longer be used, therefore, when present values are being output.

■ Connecting a M7E Display Unit

Use a 3F88L-CG□□□S Cam Output Cable to connect the M7E Display Unit.

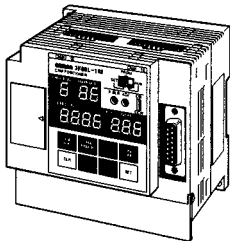

3F88L-160/162 Cam Positioner



3F88L-CG□□□S Cam Output Cable

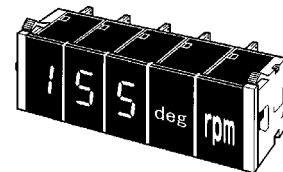

M7E Display Unit

● Functions

The present angle (in degrees) or the Resolver speed (r/min) can be displayed on a 3- or 4-digit Display Unit. The display data is set using the present value display function parameters.

If set to an automatically switching display, the present angle will be displayed when the Resolver speed is less than 4 r/min and the Resolver speed will be displayed when it is greater than 4 r/min.

● Unit Models Used

Name		Model	Remarks
Display Unit (Numerals)		M7E-01DRD2 (red, decimal, one digit)	Combine as many Display Units (Numerals) as required to achieve the required number of display digits.
		M7E-01DGD2 (green, decimal, one digit)	
Display Unit (Units)		M7E-01UR2-V (red, rpm)	If the automatically switching display function is to be used, two Display Units (Units) are required – an “r/min” Unit and a “degrees” Unit.
		M7E-01UG2-V (green, rpm)	
		M7E-01UR2-A (red, no display)	
		M7E-01UG2-A (green, no display)	
End Plate		M7E-2M (light-blue case)	One set is required.
		M7E-2M-1 (black case)	
Display Unit Connector		NRT-C (soldered-terminal type)	Enough connectors for the number of Display Units is required.
Cam Output Cable	1 m	3F88L-CG001S	One Cam Output Cable is required.
	3 m	3F88L-CG003S	

● Display Contents and Required Number of Units

Display	Resolution setting	Parameter for present value output function	Display range	Required number of Units		
				Numeric Display Unit	Units Display Unit	Display Unit Connectors
Present angle	360	1	0 to 359	3	---	3
	720	1	0 to 719	3	---	3
r/min	360	2	0 to 999	3	---	3
			0 to 1,600	4	---	4
Switching present angle/r/min display	360	3	0 to 359 (degrees)/ 4 to 999 (r/min)	3	1 no display Unit and 1 “rpm” Unit	5
		4	0 to 359 (degrees)/ 4 to 1,600 (r/min)	4	1 no display Unit and 1 “rpm” Unit	6
	720	3	0 to 719 (degrees)/ 4 to 800 (r/min)	3	1 no display Unit and 1 “rpm” Unit	5

**Note 1.** Refer to 3-5-2 *Initial Settings* for information on setting the display resolution.

**Note 2.** Refer to 3-6-10 *Present Value Output Function* for information on parameters for this function.

**Note 3.** One 3F88L-CG□□□S Cam Output Cable and one End Plate set are required when connecting Units other than those listed in the above table.

**Note 4.** When the resolution is set at 720, the present angle display will read “1” for every 0.5°.

• **Wiring Example**

The following wiring example is for automatically switching the 4-digit display between the present angle and the Resolver speed (with units also displayed).

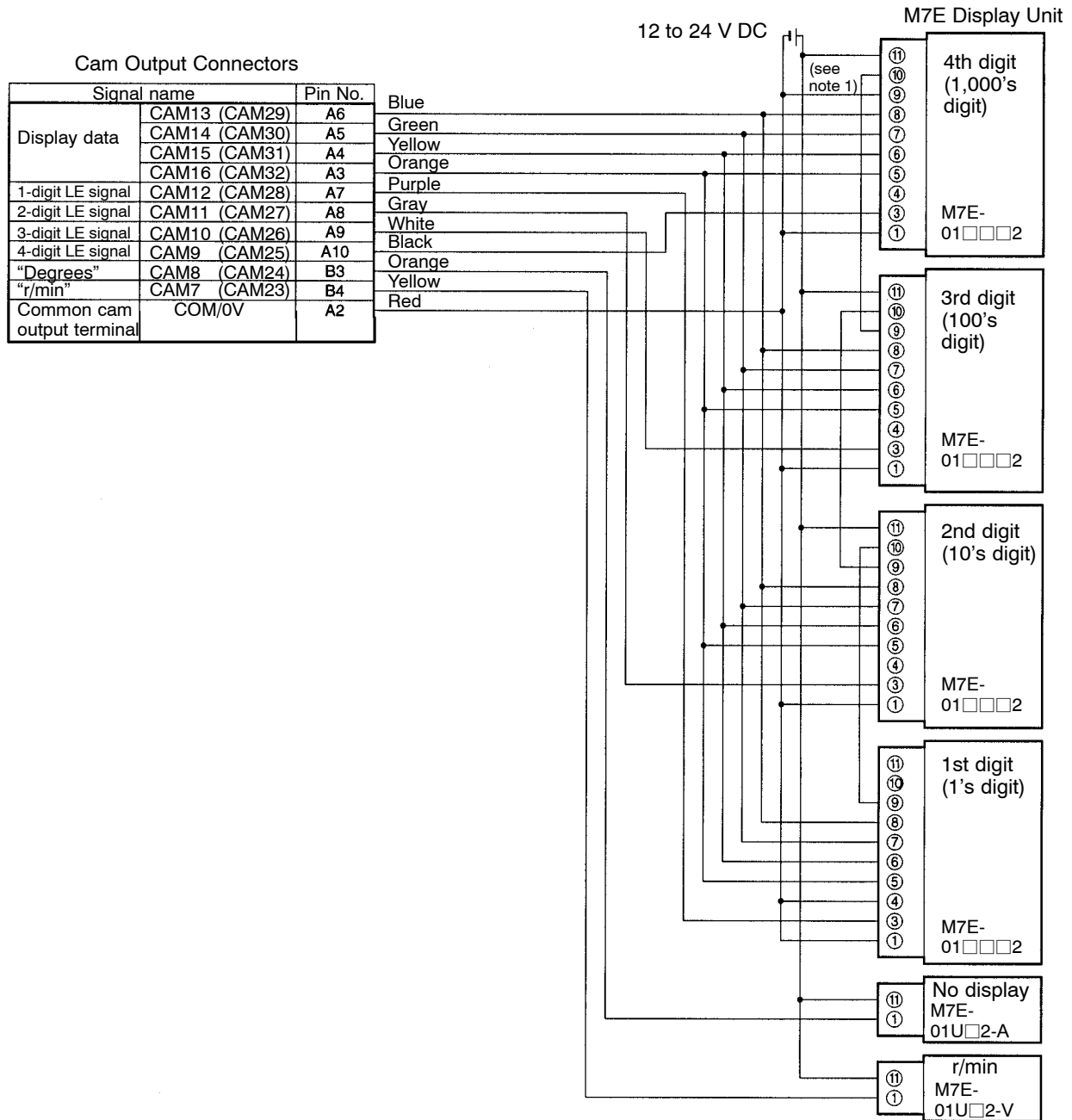

- Note 1.** If pin 9 (4th digit) is left open, a zero (0) will appear as "0." In the above wiring example, an output of 0 would appear as "0000."
- Note 2.** The cam output signal names not in parentheses will be displayed for 3F88L-160 Cam Positioners and the names in parentheses will be displayed for 3F88L-162 Cam Positioners.
- Note 3.** The circled numbers in the diagram are the terminal numbers for the NRT connectors.
- Note 4.** Reinforced insulation or double insulation must be used for the DC power supply used as an I/O power supply in order to comply to EC Directives.

**Note** 5. Some display examples are given below.

• Present angle display



• Resolver speed display

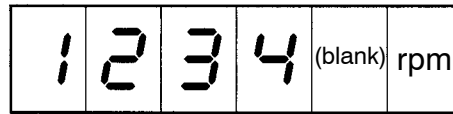

**Note** Write “deg” in the space when using a no display Unit.

■ Connecting a M7F Display Unit

Use a 3F88L-CG□□□S Cam Output Cable to connect the M7F Display Unit.

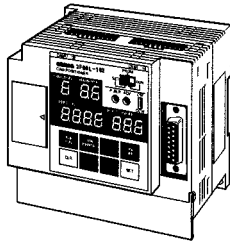

3F88L-160/162  
Cam Positioner

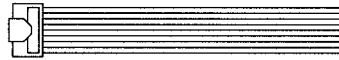

3F88L-CG□□□S  
Cam Output Cable



M7F Display Unit

● Functions

The present angle (in degrees) or the Resolver speed (r/min) can be displayed on a 4-digit numeric Display Unit. The display data is set using the present value display function parameters.

**Note** The M7F Display Unit does not have a function to change the unit of display. Do not use this Unit in automatically switching display mode.

● Unit Models Used

Name	Model	Remarks
4-digit Display Unit, character height 14 mm	M7F-4D1R (red)	Select the appropriate Unit based on the display character height, requirements for units display, and color of displayed characters.
	M7F-4D1G (green)	
4 digits + Display Unit (Units), character height 14 mm	M7F-4D1RT (red)	When using a Unit with units display, select a Unit Nameplate with the same height character display. There is no Unit Nameplate for “degrees.” Select the “no display” Unit Nameplate instead.
	M7F-4D1GT (green)	
Units Nameplate, character height 14 mm	M7F-1 (no display)	
	M7F-RPM-1 (r/min)	
4-digit Display Unit, character height 25 mm	M7F-4D2R (red)	
	M7F-4D2G (green)	
4 digits + Display Unit (Units), character height 25 mm	M7F-4D2RT (red)	
	M7F-4D2GT (green)	
Unit nameplate, character height 25 mm	M7F-2 (no display)	
	M7F-RPM-2 (r/min)	
Display Unit Connector	XG5M-2035-N (separately wired pressure-welded type)	One Display Unit Connector is required.
Display Unit Connector Cover	XG5S-1001	Two XG5S-1001 Covers or one XG5S-2012 Cover is required.
	XG5S-2012	
Cam Output Cable	1 m	One Cable is required.
	3 m	

• **Wiring Example**

The following wiring example is for four-digit display of the Resolver speed.

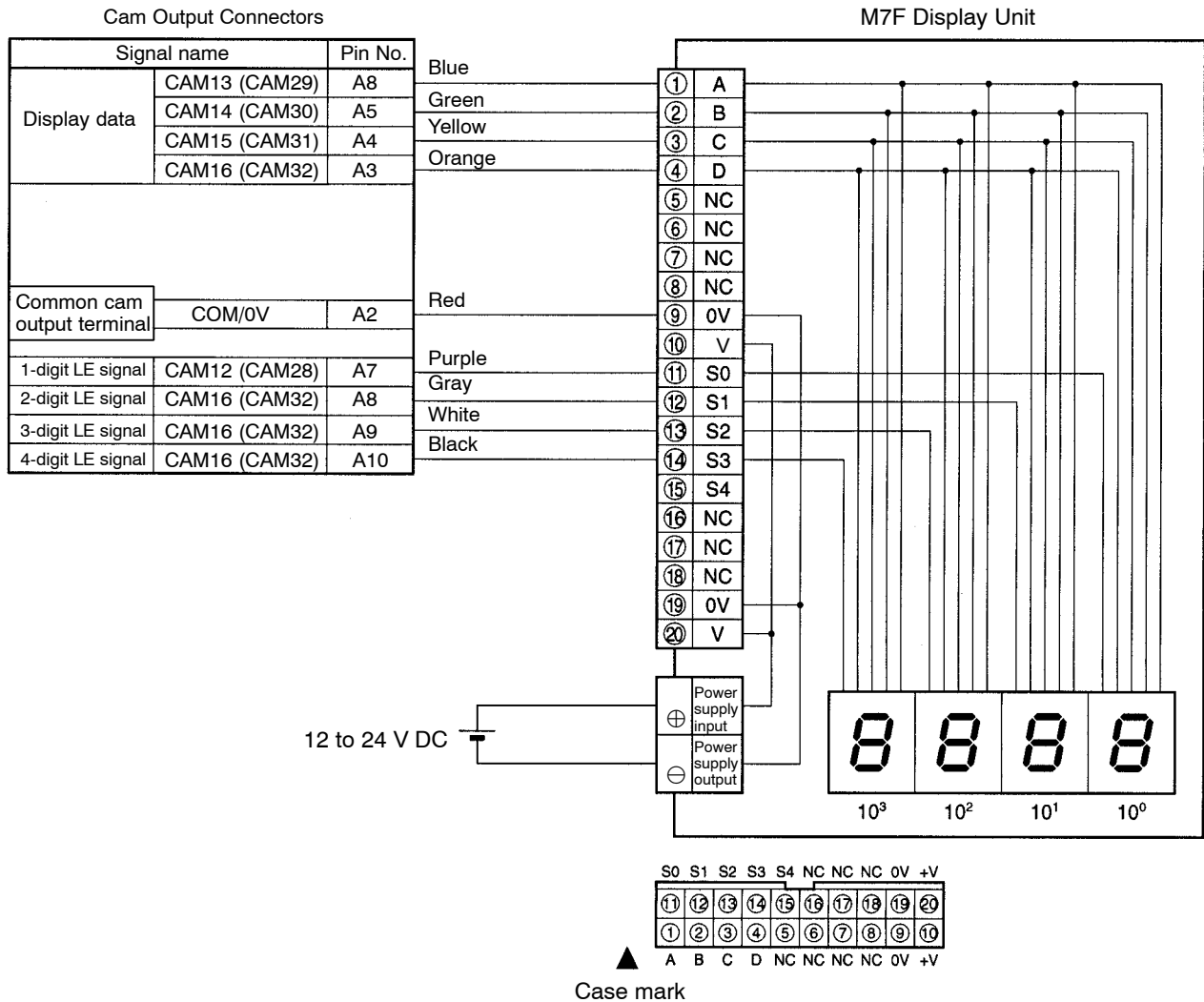

- Note 1.** The cam output signal names not in parentheses will be displayed for 3F88L-160 Cam Positioners and the names in parentheses will be displayed for 3F88L-162 Cam Positioners.
- Note 2.** The circled terminal numbers have been provided for convenience. When assembling the socket, pay attention to the direction of the polarity guide and connect the wires as shown in the above terminal layout.
- Note 3.** The case mark (▲) indicates the first digit of the M7F terminal number and is different from the connector ▲ mark described previously.
- Note 4.** A display example is shown below.

• **Resolver speed display**

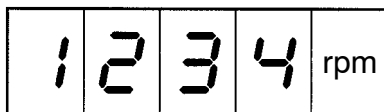

Unit Nameplate





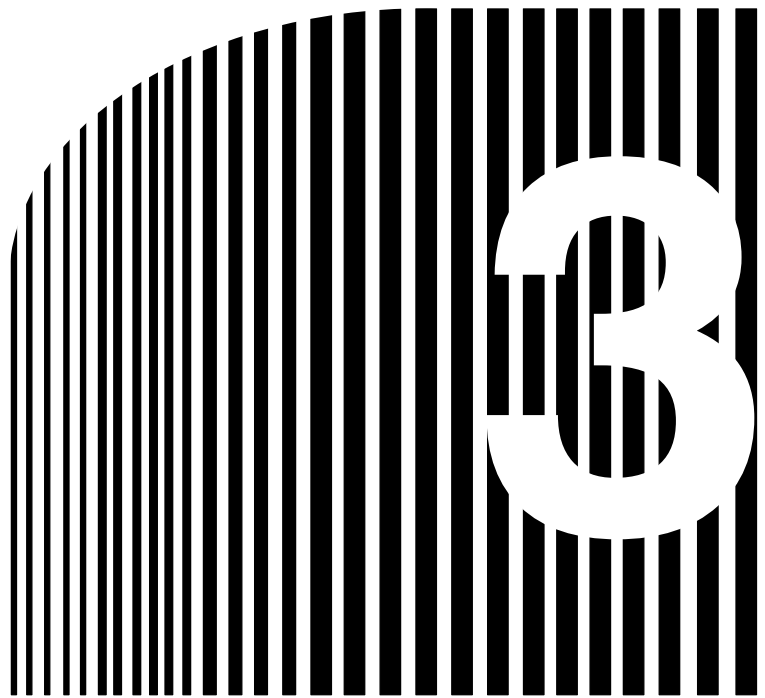

## Chapter 3







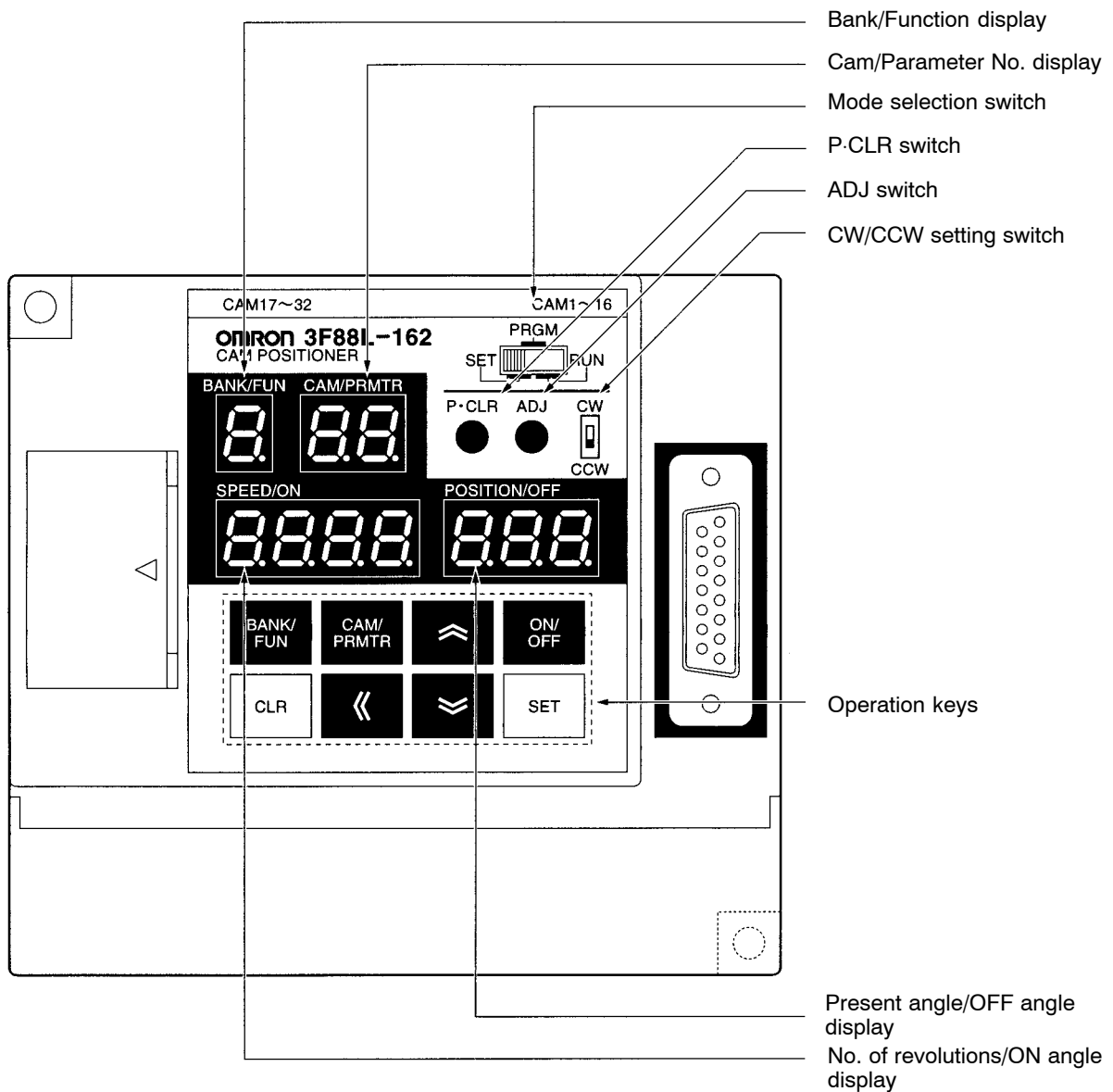

### • Operation •

- 3-1 Nomenclature of Display and Operation Sections
- 3-2 Modes, Functions, and Display
- 3-3 Operation Procedure
- 3-4 Selecting Function Levels
- 3-5 Basic Operation
- 3-6 Applied Functions

### 3-1 Nomenclature of Display and Operation Sections



#### ■ Operation Keys

	Bank/Function Key		Down Key
	Cam/Parameter Key		Forward Key
	ON/OFF Switching Key		Clear Key
	Up Key		Set Key

■ Display Patterns for Seven-segment Display

0	1	2	3	4	5	6	7	8	9	A	b	C	d	E	F	H	n	o	P
0	1	2	3	4	5	6	7	8	9	A	b	C	d	E	F	H	n	o	P

r	t	U	u
r	t	U	u

 Marks underneath a character display indicate that the character is flashing.

### 3-2 Modes, Functions, and Display

#### ■ Modes

The 3F88L-160/162 Cam Positioner has three modes: SET, PRGM, and RUN.

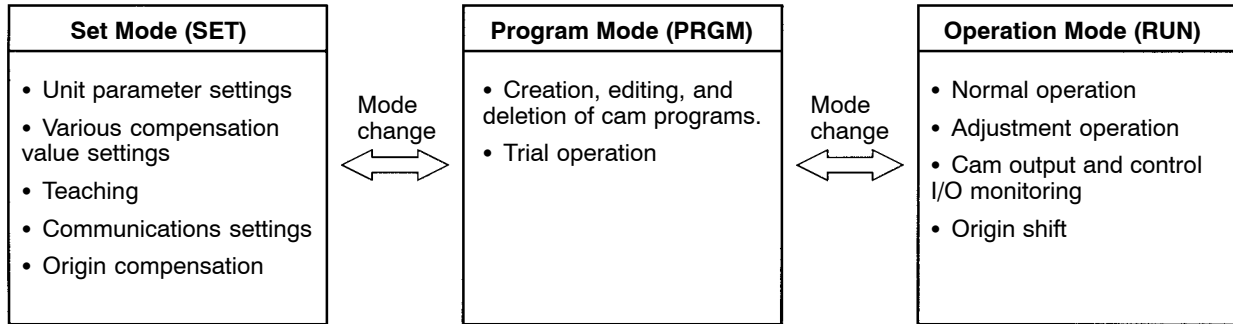

#### ■ Changing Modes

The mode selection switch is used to change modes.

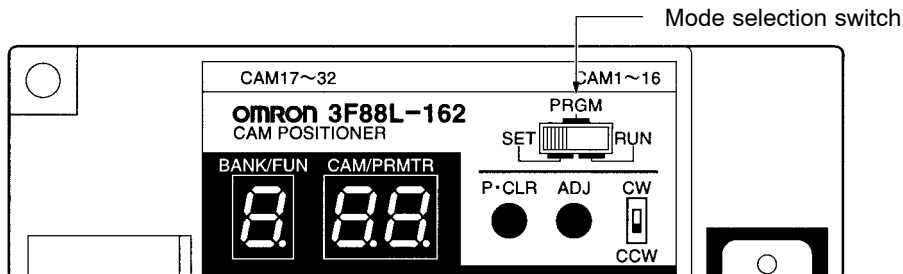

#### ■ Functions by Mode

Classification	Function name	Applicable modes	Conditions	Front panel displays		Reference section
				Function No.	Parameter No.	
Function selection	Function level selection	SET	---	U	1	3-5-1
Initial settings	Resolution selection	SET	---	A	1	3-5-2
	Rotation direction selection	SET, PRGM, RUN <b>Note</b> The CW/CCW setting switch is used.	---	---	---	3-5-2

Classifi- cation	Function name		Applicable modes	Conditions	Front panel displays		Refer- ence sec- tion	
					Function No.	Parame- ter No.		
Basic functions	Cam program writing		PRGM	---	1 to 8 (1 to 4) (see note 2)	1 to 32 (1 to 16) (see note 1)	3-5-3	
	Program number checking		SET	---	0 to 8 (0 to 4) (see note 2)	---	3-5-3	
	Origin compensation		Press the ADJ switch in SET mode.	The Resolver speed must be less than 4 r/min.	---	---	3-5-5	
	Cam output (from cam output connector)		RUN (only when START signal is ON) PRGM (Only during trial operation)	Output during normal operation (Depending on the output holding function when error is generated and the type of error, cam outputs may be held or turned OFF.)	---	---	3-5-6	
	Control I/O	Input signals	START (Start operation)	RUN <b>Note</b> This signal is disabled and cam output is executed when in PRGM mode and a trial operation.	---	---	---	3-5-8
			BANK1 to 3 (Change banks)	RUN	---	---	---	
			TRIG (Origin shift)	RUN	---	---	---	
			RESET (Reset)	SET, PRGM, RUN	---	---	---	
	Output signals	RUN (Cam output enabled)	RUN (Only when START signal is ON) PRGM (Only during trial operation)	ON during normal operation (cam output enabled).	---	---		
		M-DET (Resolver rotation detection)	RUN PRGM (Only during trial operation)	ON when Resolver speed is 4 r/min or greater.	---	---		
ERROR (Error)		SET, PRGM, RUN	OFF when an error has been generated.	---	---			
I/O monitor		RUN (Possible when START signal is ON or OFF.)	---	o	1, 2	3-5-7		

Classification	Function name	Applicable modes	Conditions	Front panel displays		Reference section
				Function No.	Parameter No.	
Applied functions	Origin compensation value setting <b>Note</b> Origin compensation can also be performed as a basic function at function level 0 or 1	SET	---	b	1	3-6-4
	Origin shift (operation) <b>Note</b> Used for both origin compensation operation and compensation value.	TRIG input in RUN mode (possible when START signal is ON or OFF.)	Resolver speed must be less than 4 r/min.	---	---	
	Backlash compensation value setting	SET	---	b	2	3-6-5
	Enable/disable backlash compensation setting	SET	---	H	1	
	Backlash compensation	RUN PRGM (trial operation only) SET (only when teaching)	Only when backlash compensation value is enabled.	---	---	
	Advance angle compensation setting	SET	---	b	3, 4, 5	3-6-6
	Advance angle compensation enable/disable setting	SET	---	H	2	
	Advance angle compensation	RUN PRGM (trial operation only) SET (only when teaching)	---	---	---	
	Cam protect setting	SET	---	C	---	3-6-7
	Cam protect function (operation)	PRGM	The power must be reset to ON after cam protect has been set.	---	---	
	One-direction function setting	SET	---	F	---	3-6-8
	One-direction function (operation)	RUN (except during compensation operation)	---	---	---	
	Output hold setting	SET	---	H	3	3-6-9

Classification	Function name		Applicable modes	Conditions	Front panel displays		Reference section	
					Function No.	Parameter No.		
Applied functions	Output hold function (operation)		When switching from RUN mode to PRGM or SET mode (when the START signal is ON).	The power must be reset to ON after output hold has been set. The START signal must be ON (cam outputs will be OFF if the START signal is OFF). The RESET signal must be OFF (cam outputs will be OFF if the RESET signal is ON).	---	---	3-6-9	
	Present value output setting		SET	---	H	4	3-6-10	
	Present value output function (operation)		SET, PRGM, RUN	The power must be reset to ON after present value output has been set. Shared with a cam output.	---	---		
	Cam program creating/ changing	Pulse output setting	SET	---	P	---	3-6-11	
		Teaching	SET	Resolver speed must be less than 4 r/min.	d	---	3-6-12	
	Cam outputs/cam program changing	Trial operation	PRGM	---	1 to 8 (1 to 4) (see note 2)	1 to 32 (1 to 16) (see note 1)	3-6-14	
		Adjustment operation	RUN	---	1 to 8 (1 to 4) (see note 2)	1 to 32 (1 to 16) (see note 1)	3-6-14	
	Communications	CompoWay/F communications function		SET, PRGM, RUN (the content of the communications will differ for each mode.)	---	---	---	Chapter 4
		Copy		SET	---	t	---	3-6-13
		Baud rate setting (shared with CompoWay/F and copy operation.)		SET	---	b	6	4-1 3-6-13

**Note 1.** The data for the 3F88L-160 (16-point model) Cam Positioner is shown in parentheses.

**Note 2.** The data for 720 resolution (divisions/revolution) is shown in parentheses.

■ Displays by Mode

● SET Mode

Bank/Function	Cam/Parameter	Function	Data range	SPEED/ON	POSITION/OFF
1 to 8 (1 to 4) (see note 2)	0	Origin compensation absolute angle	---	Displays the absolute angle for origin compensation.	---
	1 to 32 (1 to 16) (see note 1)	Program number checking	---	Displays the number of steps for the displayed bank or cam number.	---
A (a)	1	Resolution selection	0, 1	0: 360 divisions/revolution (factory setting) 1: 720 divisions/revolution	---
b (b)	1	Origin compensation value	0 to 359 (0 to 719) (see note 2)	Sets origin compensation value (angle data). Factory setting "0."	---
	2	Backlash compensation value	0 to 179 (0 to 359) (see note 2)	Sets backlash compensation value (angle data). Factory setting "0."	---
	3	Advance angle compensation value 1	0 to 1600 (0 to 800) (see note 2)	Sets speed data for advance angle compensation value 1. Factory setting "0."	---
			0 to 359 (0 to 719) (see note 2)	---	Sets angle data for advance angle compensation value 1. Factory setting "0."
	4	Advance angle compensation value 2	0 to 1600 (0 to 800) (see note 2)	Sets speed data for advance angle compensation value 2. Factory setting "0."	---
			0 to 359 (0 to 719) (see note 2)	---	Sets angle data for advance angle value 2. Factory setting "0."
	5	Advance angle compensation value 3	0 to 359 (0 to 719) (see note 2)	---	Sets angle data for advance angle compensation value 3 (advance angle compensated position). Factory setting "0."
	6	Baud rate	1, 2	1: 9,600 bps (factory setting) 2: 19,200 bps	---



Bank/Function	Cam/Parameter	Function	Data range	SPEED/ON	POSITION/OFF
c (c)	---	Cam protect	---	Protection can be set or released for each cam number or for all cams in a bank number. (Factory setting: "unprotected")	Protect can be set or released for each cam number or for all cams in a bank number (Factory setting "unprotected")
d (d)	---	Teaching	---	Present Resolver angle can be input as ON angle data.	Present Resolver angle can be input as OFF angle data.
F (f)	---	One-direction function setting	0 to 2	---	0: One-direction function disabled (factory setting) 1: Enabled in forward direction 2: Enabled in reverse direction
H (h)	1	Backlash compensation enable/disable setting	0, 1	0: Backlash compensation disabled (factory setting) 1: Backlash compensation enabled	---
	2	Advance angle compensation enable/disable setting	0, 1	0: Advance angle compensation disabled (factory setting) 1: Advance angle compensation enabled	---
	3	Output hold	0, 1	0: Output hold disabled (factory setting) 1: Output hold enabled	---

Bank/Function	Cam/Parameter	Function	Data range	SPEED/ON	POSITION/OFF
H (h)	4	Present value output setting	0 to 4	0: No present value output function (factory setting) 1: 4-digit present angle (no units) 2: 4-digit number of rotations (no units) 3: Automatic switching of 3-digit present angle and number of rotations (with units) 4: Automatic switching of 4-digit present angle and number of rotations (with units)	---
P (p) (see note 4)	---	Pulse output setting	---	Writes pulse output program to any bank or cam number (sets pulse number).	(Sets pulse start position.)
t (t) (see note 4)	0	Data transfer (Slave setting)	---	(Operates on a command issued from Master Unit.)	---
	1	Data transfer (Master setting)	0 to 3	0: Disabled (factory setting) 1: Read data 2: Write data 3: Verify data	---
U (u)	1	Function level selection	0 to 2	0: Function level 0 (monitor only) 1: Function level 1 (basic operation/monitor only) (factory setting) 2: Function level 2 (all functions)	---
---	---	Error display	---	E--** (error display)	---

**Note 1.** The data for the 3F88L-160 (16-point model) Cam Positioner is shown in parentheses.

**Note 2.** The data for 720 resolution (divisions/revolution) is shown in parentheses. The angles will be set and displayed as “1” for 0.5°.

**Note 3.** Functions A, b, C, F, H, and U will be enabled after the power has been turned OFF and then ON again.

**Note 4.** Functions P and t are special operations that are not stored as parameters.

● RUN Mode

Bank/Function	Cam/Parameter	Start input	SPEED/ON	POSITION/OFF
1 to 8 (1 to 4) (see note 2)	---	OFF	Number of Resolver rotations (r/min)	Present angle
	ru (rU)	ON		
1 to 8 (1 to 4) (see note 2)	1 to 32 (1 to 16) (see note 1)	ON	Compensation operation ON angle	Compensation operation OFF angle
o (o)	1	---	Cam output monitor	
	2	---	Control I/O monitor	
---	---	---	E-** (error display)	---

**Note 1.** The data for the 3F88L-160 (16-point model) Cam Positioner is shown in parentheses.

**Note 2.** The data for 720 resolution (divisions/revolution) is shown in parentheses. The angles will be set and displayed as “1” for 0.5°.

● PRGM Mode

Bank/Function	Cam/Parameter	SPEED/ON	POSITION/OFF
1 to 8 (1 to 4) (see note 2)	1 to 32 (1 to 16) (see note 1)	ON angle	OFF angle
1 to 8 (1 to 4) (see note 2)	1 to 32 (1 to 16) (see note 1)	“t (t)” + ON angle (trial operation)	OFF angle (trial operation)
---	---	E-** (error display)	---

**Note 1.** The data for the 3F88L-160 (16-point model) Cam Positioner is shown in parentheses.

**Note 2.** The data for 720 resolution (divisions/revolution) is shown in parentheses. The angles will be set and displayed as “1” for 0.5°.

### 3-3 Operation Procedure

#### 3-3-1 Before Operation

##### ■ Basic Use

- The procedure for using the Cam Positioner at function level 1 (basic operation/monitor only) is outlined below.

Procedure	Contents	Reference section
Installation	Install the Cam Positioner according to the installation environment conditions.	2-2
Wiring	Connect the wiring for the power supply, Resolver, and peripheral devices.	2-3
Power ON	<p><b>Before the power is turned ON:</b></p> <ul style="list-style-type: none"> <li>• Check that the wires and connectors for the Resolver and peripheral devices have been connected properly.</li> <li>• Check that the Resolver and the machinery are not connected.</li> </ul> <p><b>After the power is turned ON:</b></p> <ul style="list-style-type: none"> <li>• Check that there are no error codes displayed (E-**).</li> <li>• Set the mode selection switch to RUN and check that the number of revolutions and the present angle display changes when the Resolver axis is rotated by hand.</li> </ul>	
Function level selection	Select function level 1 (basic operation/monitor only).	3-5-1
Initial settings	Set the resolution (SET mode) and rotation direction (CW/CCW) to suit the application.	3-5-2
Power resetting (OFF to ON)	Turn ON the power to enable the set parameters.	
Creation and confirmation of cam programs	Create and check cam programs (PRGM mode). Check the number of programs (SET mode).	3-5-3
Connection between Resolver and machinery	Turn OFF the power and connect the Resolver and the machinery.	3-5-4
Execution of origin compensation	Turn ON the power and execute origin compensation (use the ADJ switch in SET mode).	3-5-5
Operation/monitoring	Change to RUN mode and check the operation of the machinery and monitor the I/O status. Correct the cam program if required (PRGM mode).	3-5-6
Function level selection	If required, set to function level 0 (monitor only) to prevent faulty operation.	3-4

**Note** This procedure is applicable when only the basic functions (function level 1) are used. In the cases outlined below, the applied functions (function level 2) must be used. (Refer to 3-6 *Applied Functions*.)

- When setting origin compensation values, using backlash compensation, advance angle compensation, and other compensation functions.
- When executing a trial or adjustment operation.

- When using the teaching function.
- When setting pulse output, cam protect, output hold, one-direction function, and present value output.

■ **Applied**

• The procedure for using the Cam Positioner at function level 2 (all functions) is outlined below.

Procedure	Contents	Reference section
Installation	Install the Cam Positioner according to the installation environment conditions.	2-2
Wiring	Connect the wiring for the power supply, Resolver, and peripheral devices.	2-3
Power ON	<p><b>Before the power is turned ON:</b></p> <ul style="list-style-type: none"> <li>• Check that the wires and connectors for the Resolver and peripheral devices have been connected properly.</li> <li>• Check that the Resolver and the machinery are not connected.</li> </ul> <p><b>After the power is turned ON:</b></p> <ul style="list-style-type: none"> <li>• Check that there are no error codes displayed (E-**).</li> <li>• Set the mode selection switch to RUN and check that the number of revolutions and the present angle display changes when the Resolver axis is rotated by hand.</li> </ul>	
Function level selection	Select function level 2 (all functions).	3-6-1
Initial settings	Set the resolution (SET mode) and rotation direction (CW/CCW) to suit the application.	3-5-2
Power resetting (OFF to ON)	Turn ON the power to enable the set parameters.	
Parameter settings	Make the parameter settings.	3-6-2 and 3-6-3
Power resetting (OFF to ON)	Turn ON the power to enable the set parameters.	
Creation and confirmation of cam programs	Create and check cam programs (PRGM mode). Check the number of programs (SET mode).	3-5-3
Connection between Resolver and machinery	Turn OFF the power and connect the Resolver and the machinery.	3-5-4
Execution of origin compensation	Turn ON the power and execute origin compensation (use the ADJ switch in SET mode).	3-5-5
Teaching	If required, use the teaching function (SET mode) and create a cam program while operating the machinery manually.	3-6-12
Trial operation	Change to PRGM mode, and, if required, adjust the cam program while checking the timing of the cam output.	3-6-14
Operation/monitoring	Change to RUN mode and check the operation of the machinery and monitor the I/O status. Correct the cam program if required (PRGM mode).	3-5-6
Origin shift execution	If required, turn ON TRIG input and execute origin shift (RUN mode).	3-6-4
Compensation operation	If required, adjust the cam program while checking the timing of the cam output.	3-6-14
Function level selection	If required, set to function level 0 (monitor only) to prevent faulty operation.	3-4

### 3-4 Selecting Function Levels

Three function levels are available to limit 3F88L-160/162 Cam Positioner functions by setting the function level selection (Function No. U).

Limiting the Cam Positioner functions protects it from being incorrectly set or operated by the user.

- Function Level 0 (Monitor Only)

Cam output and monitoring are enabled.

Cam program writing and parameter setting cannot be made.

Function level 0 is designed to prevent inadvertent changes to the cam program or parameters.

Functions for which the settings have already been completed are enabled and may be used at this level.

- Function Level 1 (Basic Operation/Monitor Only) (Factory Setting)

In addition to the functions available at function level 0, cam programs may be edited.

This function level is used for basic operation.

- Function Level 2 (All Functions)

All Cam Positioner functions are enabled.

This function level is for using applied functions.

It is recommended, therefore, that cam programs be created and parameters set at level 2 (or level 1) first and then the 3F88L-160/162 Cam Positioner be used at level 0 (or level 1).

#### ■ Limiting Functions by Function Level

The following table shows how functions are limited by the function level settings. The “Yes” indicates that that function is enabled and “No” indicates that the function is disabled.

Classification	Function	Contents	Function level			Reference
			0 (Monitor only)	1 (Basic operation/monitor only)	2 (All functions)	
Initial settings	Resolution selection (setting)	Set the resolution for one Resolver rotation. (360 or 720 divisions/rotation)	No	Yes	Yes	3-5-2
	Resolution selection (operation)		Yes	Yes	Yes	
	Rotation direction selection (setting)	Select either CW or CCW direction.	Yes	Yes	Yes	3-5-2
	Rotation direction selection (operation)		Yes	Yes	Yes	

Classifi- cation	Function	Contents	Function level			Refer- ence
			0 (Moni- tor only)	1 (Basic opera- tion/ monitor only)	2 (All func- tions)	
Basic functions	Cam program writing	Writes and edits cam programs (settings for cam output ON/OFF angles)	No	Yes	Yes	3-5-3
	Program number checking	Checks the number of cam program steps.	Yes	Yes	Yes	3-5-3
	Origin compensation	When the ADJ switch is pressed in SET mode, the present Resolver angle at that time is changed to 0 or to the origin compensation value.	Yes	Yes	Yes	3-5-5
	Cam output (from cam output connector)	While the START signal is ON in RUN mode, the cam outputs for the specified bank number are turned ON or OFF according to the cam program and present Resolver angle.	Yes	Yes	Yes	3-5-6

Classification	Function		Contents	Function level			Reference		
				0 (Monitor only)	1 (Basic operation/monitor only)	2 (All functions)			
Basic functions	Control I/O	Input signals	START (Start operation)	While the START signal is ON in RUN mode, the cam outputs for the specified bank number are turned ON or OFF according to the cam program and present Resolver angle.	Yes	Yes	Yes	3-5-8	
			BANK1 to 3 (Change banks)	Specifies the bank number to be executed.	Yes	Yes	Yes		
			TRIG (Origin shift)	When the TRIG signal is turned ON, origin shift is executed.	Yes	Yes	Yes		
			RESET (Reset)	When the RESET signal is turned ON, hardware reset is executed.	Yes	Yes	Yes		
	Output signals	Output signals	RUN (Cam output enabled)	Turns ON when cam output is enabled.	Yes	Yes	Yes		
			M·DET (Resolver rotation detection)	Turns ON when Resolver speed is 4 r/min or greater. (Origin compensation, origin shift, and teaching operations cannot be performed while M·DET is turned ON.)	Yes	Yes	Yes		
			ERROR (Error)	Turns OFF when an error is generated.	Yes	Yes	Yes		
	I/O monitor			Monitors Resolver speed, present angle, cam output status, and control I/O signal status. <b>Note</b> Effective for troubleshooting at startup.	Yes	Yes	Yes		3-5-7



Classification	Function	Contents	Function level			Reference
			0 (Monitor only)	1 (Basic operation/monitor only)	2 (All functions)	
Applied functions	Origin compensation value setting	<p>Sets the compensation value to match the mechanical origin to the Cam Positioner origin.</p> <p><b>Note</b> The compensation value is shared by the origin shift operation and the origin compensation operation.</p> <p><b>Note</b> The origin compensation operation is possible even with the basic functions (function levels 0 and 1).</p>	No	No	Yes	3-6-4
	Origin shift (operation)	When the TRIG input is turned ON in RUN mode, the present Resolver angle at that time is changed to 0 or to the origin compensation value.	Yes	Yes	Yes	
	Backlash compensation value setting	Sets a value equivalent to the mechanical looseness.	No	No	Yes	3-6-5
	Enable/disable backlash compensation setting	Enables/disables the backlash compensation value.	No	No	Yes	
	Backlash compensation	When the backlash compensation value is enabled, provides cam outputs in conformance with the mechanical looseness.	Yes	Yes	Yes	

Classifi- cation	Function	Contents	Function level			Refer- ence
			0 (Moni- tor only)	1 (Basic opera- tion/ monitor only)	2 (All func- tions)	
Applied functions	Advance angle compensation setting	Sets a compensation value to advance all cam output ON and OFF angles in proportion to the number of Resolver rotations.	No	No	Yes	3-6-6
	Advance angle compensation enable/disable setting	Enables/disables the advance angle compensation value.	No	No	Yes	
	Advance angle compensation	When the advance angle compensation value is enabled, advances the ON and OFF angles in proportion to the number of Resolver rotations.	Yes	Yes	Yes	
	Cam protect setting	Protects ON/OFF angle settings (cam programs) for each bank and cam.	No	No	Yes	3-6-7
	Cam protect function (operation)		Yes	Yes	Yes	
	One-direction function setting	Enables cam outputs when the Resolver is rotating in one direction only, either forward or reverse.	No	No	Yes	3-6-8
	One-direction function (operation)		Yes	Yes	Yes	
	Output hold setting	When switching from RUN to PRGM or SET modes or when an error is generated, holds the cam output status.	No	No	Yes	3-6-9
	Output hold function (operation)		Yes	Yes	Yes	
	Present value output setting	Using cam output signals, outputs signal connecting to M7E, M7F or other Display Units.  <b>Note</b> Uses CAM 9(7) to 16 for 3F88L-160 and CAM 25 (23) to 32 3F88L-162.	No	No	Yes	3-6-10
Present value output function (operation)	Yes		Yes	Yes		

Classification	Function		Contents	Function level			Reference
				0 (Monitor only)	1 (Basic operation/monitor only)	2 (All functions)	
Applied functions	Cam program creating/changing	Pulse output setting	Creates cam programs that turn ON and OFF at constant intervals in any bank or cam number.	No	No	Yes	3-6-11
		Teaching	Inputs data from the Resolver as ON/OFF angle settings.	No	No	Yes	3-6-12
	Cam outputs/cam program changing	Trial operation	When the system starts up, checks the cam output status in PRGM mode and changes (adjusts) the ON/OFF angle one setting at a time.	No	No	Yes	3-6-14
		Adjustment operation	After the system has started operating, checks the cam output status in PRGM mode and changes (adjusts) the ON/OFF angles one setting at a time.	No	No	Yes	3-6-14
	Communications	CompoWay/F communications function	Acts as the Slave Unit for CompoWay/F communications and reads/writes Cam Positioner programs and parameters from the host CPU and monitors present angle and number of rotations.	Yes	Yes	Yes	Section 4
		Copy	Transfers data (cam programs, parameters) between Cam Positioners.	No	Yes	Yes	3-6-13
		Baud rate setting	Sets a common baud rate for the CompoWay/F and copy functions.	No	No	Yes	3-6-13
Baud rate setting operation	Yes	Yes		Yes	4-1 3-6-13		

### 3-5 Basic Operation

#### 3-5-1 Function Level Selection Setting (SET Mode)

##### ■ Function Level Selection Setting and Checking









Check if the function level is set to function level 1 (basic operation/monitor only). Change to function level 1 (basic operation/monitor only) if set to a different level.

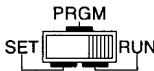
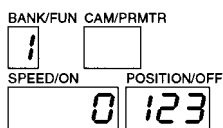

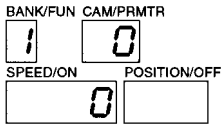
Function level 0 1 2

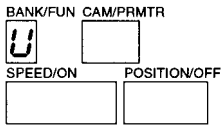
Function No.	Parameter No.	Function	Setting range	Details
U (u)	1	Function level selection	0 to 2	0: Function level 0 (monitor only) 1: Function level 1 (basic operation/monitor only) (factory setting) 2: Function level 2 (all functions)

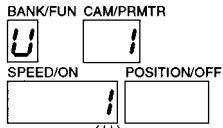
##### ● Procedure

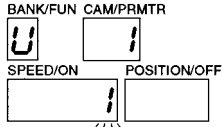
Set the function level selection to “1” (function level 1).

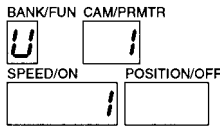
Operation	Display	Explanation
		If the Cam Positioner power is turned ON while in RUN mode, the display will appear as shown to the left. <ul style="list-style-type: none"> <li>• Bank/Function: Displays the bank number specified by the bank selection input (banks 1 to 3).</li> <li>• Cam/Parameter: (Clear)</li> <li>• SPEED/ON angle display: Displays the Resolver speed (r/min).</li> <li>• POSITION/OFF: Displays the present angle.</li> </ul>
		Use the mode selection switch to change to SET mode.
		Keep pressing the Bank/Function Key until “U” appears on the display. <b>Note</b> The display will change from 1→2→...→8→A→t→U→1→..
		Press the Set Key to allow settings to be made. <ul style="list-style-type: none"> <li>• Cam/Parameter number display: “1”</li> <li>• SPEED/ON angle display: Flashes current setting</li> </ul>
		If the setting is not on “1,” use the Up or Down Key to change to “1” (function level 1). 0: Function level 0 1: Function level 1 2: Function level 2

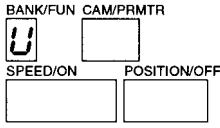
Operation	Display	Explanation
		Press the Set Key to confirm the settings. The setting will stop flashing for approximately 1 second and then resume flashing. <b>Note</b> When a setting is flashing, the Up and Down Keys are enabled and the setting may be changed.
		Press the Bank/Function Key. The display will return to only the function number that appears. Turn OFF the power supply. (The settings will now be enabled.)

**Note 1.** The functions are enabled once the power has been turned OFF and then ON again.

**Note 2.** The display will change as shown below when the Bank/Function Key is pressed repeatedly to set the function number.

Function level 0: 1→2→3→4→5→6→7→8→U→1→etc.

Function level 1: 1→2→3→4→5→6→7→8→A→t→U→1→etc.

Function level 2: 1→2→3→4→5→6→7→8→A→b→C→d→F→H→P→t→U→1→etc.

If the resolution selection (explained in the next section) is set to “1” (720 divisions/rotation), “5→6→7→8” will not be displayed.

### 3-5-2 Initial Settings

---

Only the rotation direction (CW/CCW selection switch) and resolution setting (SET mode) are changed at function level 1.

---

#### ■ Rotation Direction Selection Setting

The CW/CCW setting switch is used to change the direction of rotation.

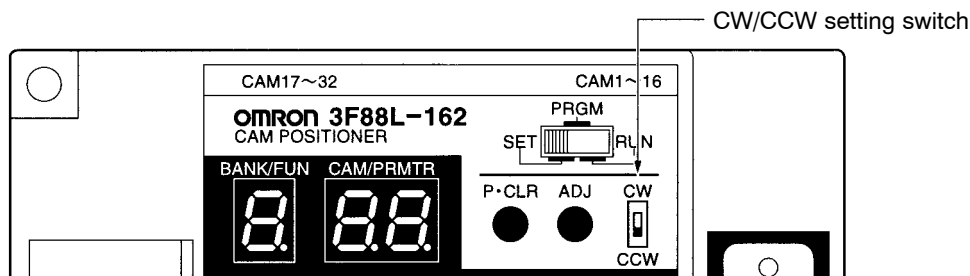

Set the direction of increasing angles to “CW” for clockwise direction when viewed from the Resolver axis, and “CCW” for counterclockwise direction (as shown in the following diagram).

**Note** These settings will be enabled by turning the power supply OFF and then ON again.

● Relationship between Resolver Rotation Direction and Rotation Direction Selection

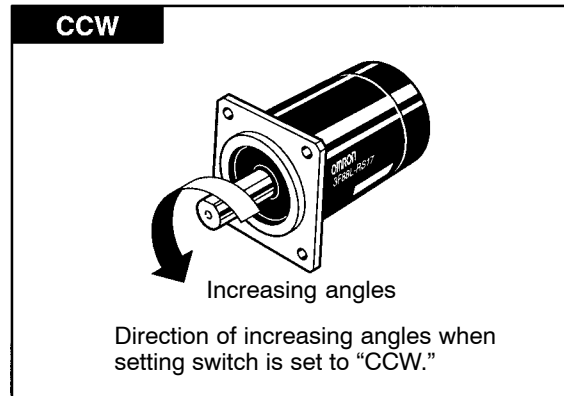
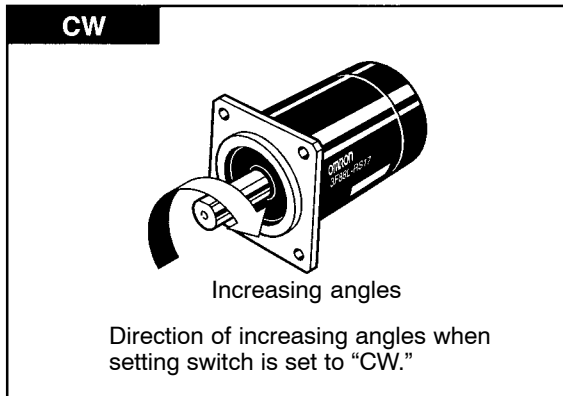

■ Resolution Selection (SET Mode)

Select a resolution of either 360 or 720 (divisions/rotation).

● Resolution Selection Details

Function level 1 2









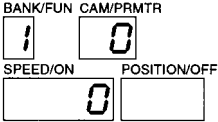

Function No.	Parameter No.	Function	Setting range	Details
A (a)	1	Resolution selection	0, 1	0: 360 divisions/rotation (factory setting) 1: 720 divisions/rotation

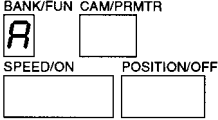
● Functions and Performances Affected by Resolution Setting

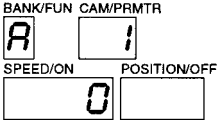
Function or Characteristic	360 resolution	720 resolution
Angle setting and display units	1° is set and displayed as "1."	0.5° is set and displayed as "1."
Permissible Resolver speed	1,600 r/min	800 r/min
No. of cam program steps	180 max.	360 max.
Number of banks	8	4

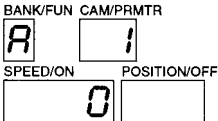
**Note** For example, to set the ON angle at 90°, the setting is "90" for a 360 resolution and "180" for a 720 resolution.

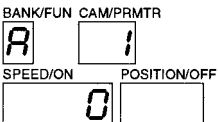
● Procedure

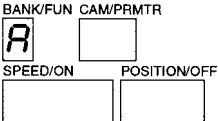
Operation	Display	Explanation
		<p>Use the mode selection switch to change to SET mode.</p>
		<p>Keep pressing the Bank/Function Key until “A” appears on the Bank/Function display.  <b>Note</b> The display for level 1 will change from “1” to “2” through to “8” then to “A,” “t,” “U,” and back to “1” and so on. (When the resolution is set to 720, “5” through “8” will not be displayed.)</p>
		<p>Press the Set Key to enable settings to be made.                      Cam/Parameter number display: “1”                      SPEED/ON angle display: Flashes current setting</p>
		<p>Press the Up or Down Keys and select the resolution to be used.                      0: 360 (divisions/rotation)                      1: 720 (divisions/rotation)</p>
		<p>Press the Set Key to confirm the settings.                      The setting will stop flashing for approximately 1 second and then resume flashing.  <b>Note</b> When a setting is flashing, the Up and Down Keys are enabled and the setting can be changed.</p>
		<p>Press the Bank/Function Key.                      The display will return to only the function number appearing.                      Turn OFF the power supply. (The settings will now be enabled.)</p>







**Note** These functions are enabled once the power has been turned OFF and then ON again.

### 3-5-3 Cam Program Creating and Checking (PRGM Mode/SET Mode)

Once the initial settings have been made, turn OFF the power and then turn it ON again. (The initial settings will be enabled once the power has been turned ON again.)  
 Next, create a cam program (cam output ON/OFF patterns) in PRGM mode.  
 Once the cam program has been created, check the number of cam program steps in SET mode.





#### ■ Outline of Program Functions

##### ● Cam Program Creation (PRGM Mode)

	Operation	Explanation
1		Set the mode selection switch to PRGM mode.
2		Press the Bank/Function Key and set the bank number.
3		Press the Cam/Parameter Key and set the cam number.
4		Set the ON angle. (Use the Up, Down, and Forward Keys)
5		Press the ON/OFF Switching Key and set the OFF angle. (Use the Up, Down, and Forward Keys)
6		Press the Set Key to confirm the settings data. The next step can now be input. (Return to step 4 to input more steps.)

Once a program has been created for one cam number, change the cam number (using the Cam/Parameter Key) and create another cam program in the same way. If multiple bank numbers are used, change the bank number (using the Bank/Function Key) and create another program in the same way.

##### ● Cam Program Checking (PRGM Mode)

	Operation	Explanation
1		Set the mode selection switch to PRGM mode.
2		Press the Bank/Function Key and set the bank number.
3		Press the Cam/Parameter Key and set the cam number.
4		Check the ON and OFF angles.
5		Press the Set Key and check the next step. (Return to step 4 of this procedure to check the next step.)









Once a program has been checked for one cam number, change the cam number (using the Cam/Parameter Key) and check another cam program in the same way. If multiple bank numbers are used, change the bank number (using the Bank/Function Key) and check another program in the same way.

● **Cam Program Deletion (PRGM Mode)**





There four methods to delete cam programs. Each of these methods will be explained in this section.

- ON/OFF angle data deleted by steps.
- ON/OFF angle data deleted by cam numbers.
- ON/OFF angle data deleted by bank numbers.
- All cam programs deleted at once.





**Deleting by Step (PRGM Mode)**

	Operation	Explanation
1		Set the mode selection switch to PRGM mode.
2		Press the Bank/Function Key and set the bank number that contains the step to be deleted.
3		Press the Cam/Parameter Key and set the cam number that contains the step to be deleted.
4		Press the Set Key to display the step to be deleted.
5		Press the Clear Key once. (The ON angle and OFF angle displays will start flashing.)
6		Press the Set Key to delete the step.

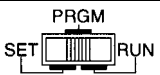

**Deleting by Cam Number (PRGM Mode)**

	Operation	Explanation
1		Set the mode selection switch to PRGM mode.
2		Press the Bank/Function Key and set the bank number that contains the cam number to be deleted.
3		Press the Cam/Parameter Key and set the cam number that is to be deleted.
4		Press the Clear Key twice. (The cam number display will start flashing.)
5		Press the Set Key to delete the cam number.

**Deleting by Bank Number (PRGM Mode)**

	Operation	Explanation
1		Set the mode selection switch to PRGM mode.
2		Press the Bank/Function Key and set the bank number that is to be deleted.
3		Press the Clear Key three times. (The bank number display will start flashing.)
4		Press the Set Key to delete the bank number.

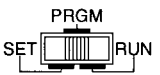

**Deleting All Cam Programs (PRGM Mode)**

	Operation	Explanation
1		Set the mode selection switch to PRGM mode.
2		Press the P-CLR switch to clear all cam programs in the Cam Positioner.

**Note** The P-CLR switch will be ignored by the system, even in PRGM mode, if the trial operation function is being used. Trial operation cannot be performed in function level 1.

**● Checking Number of Programs (SET Mode)**

Check the number of cam program steps that have been created.

	Operation	Explanation
1		Set the mode selection switch to SET mode.
2		Press the Bank/Function Key and set the bank number that contains the cam number to be checked.
3		Press the Cam/Parameter Key and set the cam number to be checked.
4		The number of steps for that cam program will appear in the SPEED/ON display.

Once the number of steps for one cam number have been checked, change the cam number (using Cam/Parameter Key) and check another cam number in the same way.

If multiple bank numbers are used, change the bank number (using the Bank/Function Key) and check another bank number in the same way.

■ **Cam Program Creation (PRGM Mode)**

Before creating cam programs, use the information contained in *7-7 Cam Programming Sheet* to write down the ON/OFF patterns so as to make the process easier.

● **Time Chart**

The following shows how to create a cam program with the following kind of ON/OFF patterns.

The resolution is set to 360 (divisions/rotation) in this example. (When the resolution is set to 720, the ON and OFF angle values will be double the values shown here.)

**Bank No. 2**

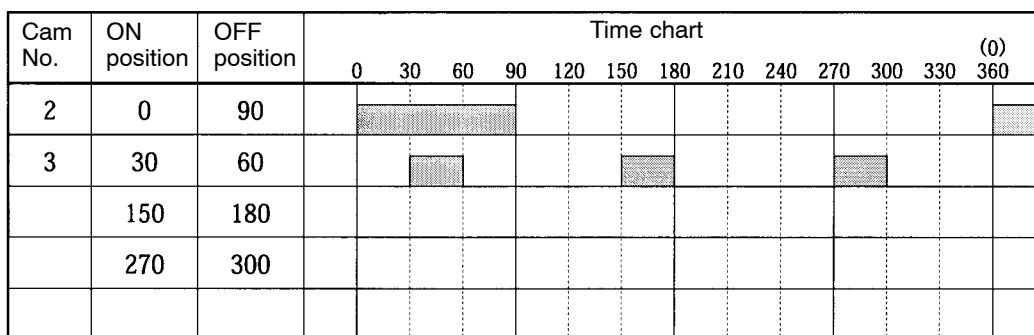









● **Display and Operation Functions in PRGM Mode**





**Display Functions**





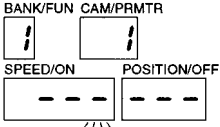

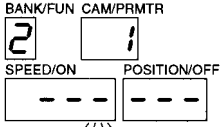

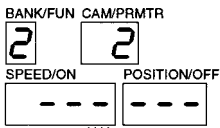

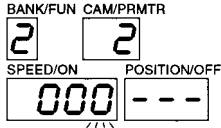



Function name	Display
Bank/Function display	Displays the bank numbers currently being programmed.
Cam/Parameter No. display	Displays the cam numbers currently being programmed.
SPEED/ON angle display	Displays ON angles or errors.
POSITION/OFF angle display	Displays OFF angles.

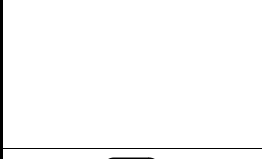
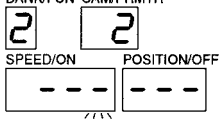

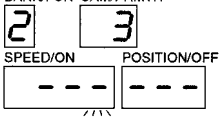

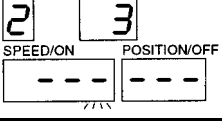

Operation Key Functions

Operation keys		Functions
	Bank/Function Key	Increases the bank number (used for setting bank numbers.)
	Cam/Parameter Key	Increases the cam number (used for setting cam numbers.)
	ON/OFF Key	Switches between ON and OFF angles.
	Up Key	Increases the numeral currently flashing (used for setting ON and OFF angles.)
	Down Key	Decreases the numeral currently flashing (used for setting ON and OFF angles.)
	Forward Key	Changes the digit of the numeral to be set (used when setting ON and OFF angles.)
	Clear Key	Clears data.
	Set Key	Confirms input data.

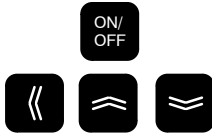
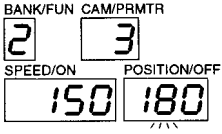
● Procedure

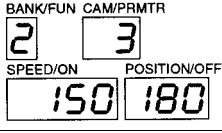
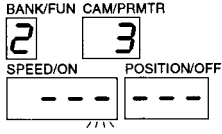
Operation	Display example	Explanation
		Use the mode selection switch to change to PRGM mode.
		Use the Bank/Function Key to set the bank number to be used. The Bank/Function display will change as shown below each time the Bank/Function Key is pressed. 1→2→3→4→5→6→7→8→1 etc. Keep pressing the Bank/Function Key until “2” appears in the Bank/Function display. <b>Note</b> When the resolution is set to 720 (divisions/rotation), the display will not include 5→6→7→8.
		Use the Cam/Parameter Key to set the cam number to be used. The Cam/Parameter No. display will change as shown below when the Cam/Parameter Key is pressed. 1→2→3→...→15→16→1→ etc. Keep pressing the Cam/Parameter Key until “2” appears in the Cam/Parameter No. display. <b>Note</b> For the 3F88L-162 (32-point model) Cam Positioner, the numbers displayed will continue to “32” and then return to “1.”

Operation	Display example	Explanation
		<p>Set the ON angle.</p> <p>Under the initial settings, the rightmost digit (the first digit) will be flashing. Press the Forward Key to move the position of the flashing digit from the first to the second digit, from the second to the third digit, and then back to the first digit again.</p> <p>Use the Up and Down Keys to increase or decrease the numerical value of the flashing digit. The operated digit will be carried over.</p> <p>If the Up and Down Keys are continually pressed, they will automatically increment and decrement, and the automatic changes will become faster the longer the key is pressed.</p> <p>The ON angle for cam number two is “0” and must, therefore, be set to “0.”</p>
		<p>Press the ON/OFF Switching Key to set the OFF angle.</p> <p>The rightmost digit (the first digit) in the POSITION/OFF display will start flashing.</p>
		<p>Set the OFF angle in the same way the ON angle was set.</p> <p>The ON angle for cam number 2 is “90” and must, therefore, be set to “90.”</p>
		<p>Press the Set Key to confirm the ON and OFF angle settings.</p> <p>The data will stop flashing for approximately one second after the Set Key is pressed.</p>
		<p>Approximately one second after the Set Key has been pressed, the next step can be input.</p>
		<p>There is only one step for cam number 2. Proceed, therefore, to the settings for cam number 3.</p> <p>Press the Cam/Parameter Key. The Cam/Parameter No. display will change from “2” to “3.”</p>
		<p>In step 1 of cam number 3, set the ON angle to “30” and the OFF angle to “60.”</p> <p>The setting method is the same as outlined previously.</p>
		<p>Press the Set Key to save the ON and OFF angle settings for step 1.</p> <p>When the Set Key is pressed, the data will stop flashing for approximately one second.</p>
		<p>Step 2 can be input approximately one second after the Set Key has been pressed.</p>

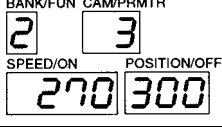
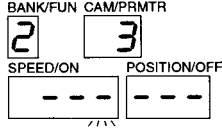
Operation	Display example	Explanation
		<p>In step 2 of cam number 3, set the ON angle to “150” and the OFF angle to “180.”</p> <p>The setting method is the same as outlined previously.</p>
		<p>Press the Set Key to save the ON and OFF angle settings for step 2.</p> <p>When the Set Key is pressed, the data will stop flashing for approximately one second.</p>
		<p>Step 3 can be input approximately one second after the Set Key has been pressed.</p>
		<p>In step 3 of cam number 3, set the ON angle to “270” and the OFF angle to “300.”</p> <p>The setting method is the same as outlined previously.</p>
		<p>Press the Set Key to save the ON and OFF angle settings for step 3.</p> <p>When the Set Key is pressed, the data will stop flashing for approximately one second.</p>
		<p>Step 4 can be input approximately one second after the Set Key has been pressed.</p>











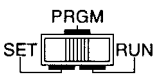
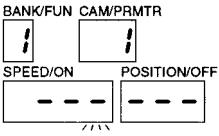

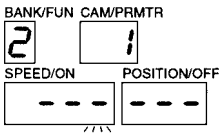
The cam program is now complete.

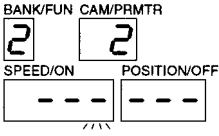

- Note 1.** If there is an error with the input data, the display will change as outlined below. Check and reset the input data.
- If data is duplicated in the ON region (the region between an ON angle and OFF angle) of a step that has been already input.
    - “E-22” (cam program duplication error) will appear in the SPEED/ON angle display. Press the Clear Key to clear the error and reset with the correct data.
  - If the input numeric data exceeds the setting range.
    - All displays will flash twice and return to the status before the data was edited. Reset with the correct data.
- Note 2.** Cam outputs turn ON at the set ON angle and turn OFF at the set OFF angle. In this cam program example, the cam output number 2 will turn ON at the point when 0° is detected and turn OFF when 90° is detected.

■ Cam Program Confirmation (PRGM Mode)

Once a cam program has been created, check that it has been created correctly.

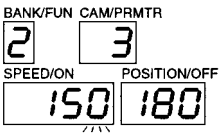
● Procedure

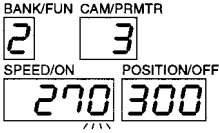
Operation	Display	Explanation
		<p>Use the mode selection switch to set to PRGM mode.</p> <p>The data for step 1 of the bank and cam numbers displayed will be displayed.</p> <p><b>Note</b> If there is no data, the display will be “---.”</p>
		<p>Use the Bank/Function Key to set the bank number to be checked.</p> <p>The Bank/Function display will change as shown below each time the Bank/Function Key is pressed.</p> <p>1→2→3→4→5→6→7→8→1 etc.</p> <p>Keep pressing the Bank/Function Key until the bank number to be checked appears.</p> <p><b>Note</b> When the resolution is set to 720 (divisions/rotation), the display will not include 5→6→7→8.</p>
		<p>Use the Cam/Parameter Key to set the cam number to be checked.</p> <p>The Cam/Parameter No. display will change as shown below when the Cam/Parameter Key is pressed.</p> <p>1→2→3→...→15→16→1→ etc.</p> <p>Keep pressing the Cam/Parameter Key until the cam number to be checked is displayed.</p> <p><b>Note</b> For the 3F88L-162 (32-point model) Cam Positioner, the numbers displayed will continue to “32” and then return to “1.”</p>
		<p>Press the Set Key to display the data for the next step.</p> <p>The display will be “---” for the last step.</p>
		<p>If the Set Key is pressed while the display shows “---,” the data for step 1 will be displayed again.</p>
		<p>Press the Cam/Parameter Key to check the contents of other cam numbers.</p> <p>The data for step 1 of the bank and cam number displayed will be displayed.</p> <p><b>Note</b> If there is no data, the display will be “---.”</p>
		<p>Press the Set Key to check data for step 2.</p>

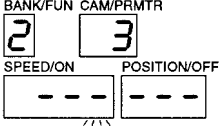
Operation	Display	Explanation
		Check the data for step 3 in the same way.
		Check data through to the last step.

Check the data for all cam programs that have been created.

If there are errors in any cam program, follow the procedure outlined in the previous section and set the correct data.



### ■ Cam Program Deletion (PRGM Mode)

This section explains how to delete cam programs after they have been created or while they are being created.





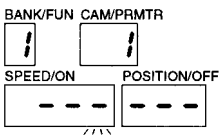

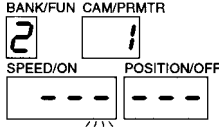
The four methods to delete cam programs are shown below. Each of these methods will be explained in this section.

- ON/OFF angle data deleted by steps.
- ON/OFF angle data deleted by cam numbers.
- ON/OFF angle data deleted by bank numbers.
- All cam programs deleted at once.



#### ● Deleting by Steps



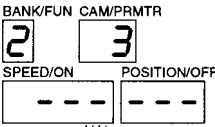

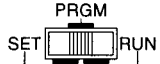
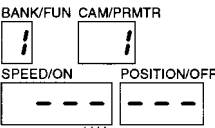

Operation	Display	Explanation
		<p>Set the mode selection switch to PRGM mode.</p> <p>The data for step 1 of the displayed bank and cam numbers will be displayed.</p> <p><b>Note</b> If there is no data, the display will be “---.”</p>
		<p>Press the Bank/Function Key and set the bank number that contains the step to be deleted.</p> <p>The Bank/Function display will change as shown below each time the Bank/Function Key is pressed.</p> <p>1→2→3→4→5→6→7→8→1 etc.</p> <p>Keep pressing the Bank/Function Key until the bank number to be set appears.</p> <p><b>Note</b> When the resolution is set to 720 (divisions/rotation), the display will not include 5→6→7→8.</p>

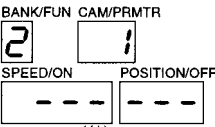



Operation	Display	Explanation
		<p>Press the Cam/Parameter Key and set the cam number that contains the step to be deleted.</p> <p>The Cam/Parameter No. display will change as shown below when the Cam/Parameter Key is pressed.</p> <p>1→2→3→...→15→16→1→ etc.</p> <p>Keep pressing the Cam/Parameter Key until the cam/parameter number to be set is displayed.</p> <p><b>Note</b> For the 3F88L-162 (32-point model) Cam Positioner, the numbers displayed will continue to “32” and then return to “1.”</p>
		<p>Press the Set Key to display the step to be deleted.</p> <p>Press the Set Key to display the cam program steps in order.</p> <p>Keep pressing the Set Key until the step to be deleted appears.</p> <p>When the display is blank (“— — —”), press the Set Key to return to step 1.</p>
		<p>Press the Clear Key to delete the step that is displayed</p> <p>If the Clear Key is pressed once, the ON angle and OFF angle displays will start flashing (which means the step is ready to be deleted).</p> <p><b>Note</b> If the Clear Key is pressed twice, the cam number will start flashing (which means that cam number is ready to be deleted). If the Clear Key is pressed three times, the bank number will start flashing (which means that that bank number is ready to be deleted). If the Clear Key is pressed four times, the display will return to the original display (nothing will be deleted).</p>
		<p>Press the Set Key while the ON and OFF angle displays are flashing, and that step will be deleted.</p> <p>Once the step has been deleted, the final step for that cam number (“— — —”) will be displayed (ready for input).</p>

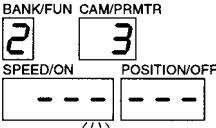

● Deleting by Cam Number

Operation	Display	Explanation
		<p>Set the mode selection switch to PRGM mode.</p> <p>The data for step 1 of the bank and cam numbers displayed will be displayed.</p> <p><b>Note</b> If there is no data, the display will be “— — —.”</p>
		<p>Press the Bank/Function Key and set the bank number that contains the cam number to be deleted.</p> <p>The Bank/Function display will change as shown below each time the Bank/Function Key is pressed.</p> <p>1→2→3→4→5→6→7→8→1 etc.</p> <p>Keep pressing the Bank/Function Key until the bank number to be set appears.</p> <p><b>Note</b> When the resolution is set to 720 (divisions/rotation), the display will not include 5→6→7→8.</p>

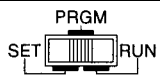
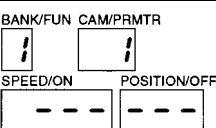

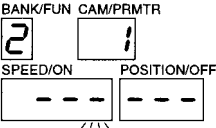
Operation	Display	Explanation
		<p>Press the Cam/Parameter Key and set the cam number that is to be deleted.</p> <p>The Cam/Parameter No. display will change as shown below when the Cam/Parameter Key is pressed.</p> <p>1→2→3→...→15→16→1→ etc.</p> <p>Keep pressing the Cam/Parameter Key until the cam/parameter number to be deleted is displayed.</p> <p><b>Note</b> For the 3F88L-162 (32-point model) Cam Positioner, the numbers displayed will continue to “32” and then return to “1.”</p>
 		<p>Press the Clear Key twice to delete the displayed cam number.</p> <p>The cam number display will start flashing when the Clear Key is pressed twice (which means the cam number is ready to be deleted).</p> <p><b>Note</b> If the Clear Key is pressed once, the ON and OFF angle display will start flashing (which means the step is ready to be deleted). If the Clear Key is pressed three times, the bank number will start flashing (which means that that bank number is ready to be deleted). If the Clear Key is pressed four times, the display will return to the original display (nothing will be deleted).</p>
		<p>While the cam number display is flashing, press the Set Key to delete the cam number that is flashing.</p> <p>Once the cam number has been deleted, the ON and OFF angle display will be “---” (which means data can be input).</p>

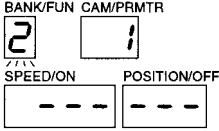
• Deleting by Bank Number

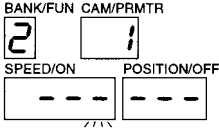
Operation	Display	Explanation
		<p>Set the mode selection switch to PRGM mode.</p> <p>The data for step 1 of the displayed bank and cam numbers will be displayed.</p> <p><b>Note</b> If there is no data, the display will be “---.”</p>
		<p>Press the Bank/Function Key and set the bank number that is to be deleted.</p> <p>The Bank/Function display will change as shown below each time the Bank/Function Key is pressed.</p> <p>1→2→3→4→5→6→7→8→1 etc.</p> <p>Keep pressing the Bank/Function Key until the bank number to be deleted appears.</p> <p><b>Note</b> When the resolution is set to 720 (divisions/rotation), the display will not include 5→6→7→8.</p>

Operation	Display	Explanation
		<p>Press the Clear Key three times to delete the displayed bank number.</p> <p>The bank number display will start flashing when the Clear Key is pressed three times (which means the bank number is ready to be deleted).</p> <p><b>Note</b> If the Clear Key is pressed once, the ON and OFF angle display will start flashing (which means the step is ready to be deleted). If the Clear Key is pressed twice, the cam number will start flashing (which means that that cam number is ready to be deleted). If the Clear Key is pressed four times, the display will return to the original display (nothing will be deleted).</p>
		<p>While the bank number display is flashing, press the Set Key to delete the bank number that is flashing.</p> <p>Once the cam number has been deleted, the ON and OFF angle display will be “---” (which means data can be input).</p>

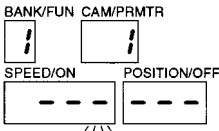
● Deleting All Cam Programs

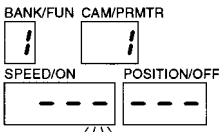
Operation	Display	Explanation
		<p>Set the mode selection switch to PRGM mode.</p> <p>The data for step 1 of the displayed bank and cam numbers will be displayed.</p> <p><b>Note</b> If there is no data, the display will be “---.”</p>
		<p>Press the P-CLR switch to clear all cam programs in the Cam Positioner.</p>

**Note** The P-CLR switch will be ignored by the system, even in PRGM mode, if the trial operation function is being used. Trial operation cannot be performed in function level 1.

■ Program Number Checking (SET Mode)

---

The number of steps in a new program are checked in SET mode.

---

● Program Number Checking Information

Function level 0 1 2

Function No.	Parameter No.	Function name	Display
1 to 8 (1 to 4) (see note 2)	0 to 32 (1 to 16) (see note 1)	Program number checking	The number of steps for the displayed bank and cam numbers will be shown in the SPEED/ON display.

**Note** 1. The numeric values for the 3F88L-160 (16-point model) Cam Positioner are shown in parentheses.

**Note** 2. The numeric values for 720 (divisions/rotation) resolution are shown in parentheses.

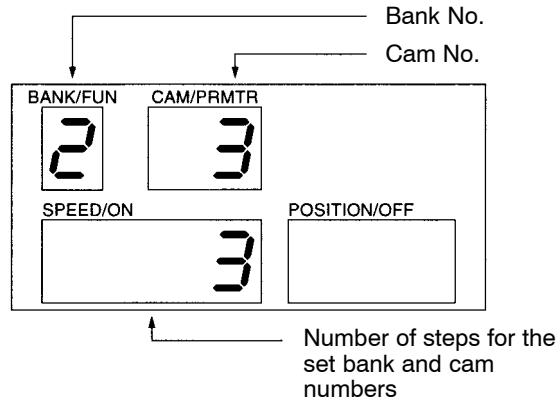

**Note** When the parameter number (PRMTR) is “0,” the absolute angle for origin compensation is shown in the SPEED/ON display.

● Procedure

Operation	Display	Explanation
	BANK/FUN CAM/PRMTR 1 0 SPEED/ON POSITION/OFF 0	Use the mode selection switch to change to SET mode.
	BANK/FUN CAM/PRMTR 2 0 SPEED/ON POSITION/OFF 0	Use the Bank/Function Key to set the bank number to be checked.  Keep pressing the Bank/Function Key until the bank number to be checked is displayed.
	BANK/FUN CAM/PRMTR 2 2 SPEED/ON POSITION/OFF 1	Use the Cam/Parameter Key to set the cam number to be checked.  Keep pressing the Cam/Parameter Key until the cam number to be checked is displayed.  The number of steps for that cam program will be shown in the SPEED/ON display.
	BANK/FUN CAM/PRMTR 2 3 SPEED/ON POSITION/OFF 3	Repeat these steps to check other cam numbers.
Keys other than	BANK/FUN CAM/PRMTR 2 0 SPEED/ON POSITION/OFF 0	Press any key other than the Cam/Parameter Key to return the Cam/Parameter No. display to “0.”
	BANK/FUN CAM/PRMTR 3 0 SPEED/ON POSITION/OFF 0	Press the Bank/Function Key while the Cam/Parameter No. display is “0” to display the next bank number (or function number).

### 3-5-4 Resolver and Machinery Connection

Once the cam programs have been completed, turn OFF the power supply (for safety) and connect the Resolver and the machinery.

#### ■ Resolver and Machinery Connection

- Turn OFF the system power supply before connecting the Resolver and machinery.
- Follow the directions in 2-2-3 *Mounting the Resolver* and attach the Resolver correctly.

### 3-5-5 Origin Compensation

Once the Resolver and machinery have been connected, turn ON the power supply and execute origin compensation.



#### ■ Origin Compensation Execution (SET Mode)

- Once the Resolver and machinery have been connected, turn ON the system power supply.
- Switch the Cam Positioner to SET mode and use the ADJ switch to execute origin compensation. (The Resolver present position is set to “0” at this point.)

**Note 1.** Origin compensation will not be executed if the Resolver speed is 4 r/min or greater.

**Note 2.** If the origin compensation value is set to a value other than “0,” parameter settings (origin compensation value settings) must be made at function level 2. (Refer to 3-6-4 *Origin Compensation and Origin Shift.*)

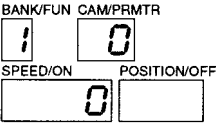
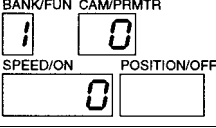
#### ● Procedure

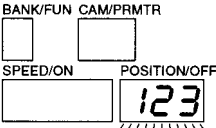
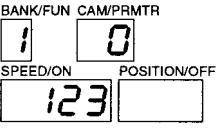
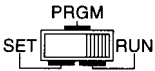
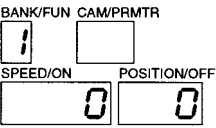
Operation	Display	Explanation
		Use the mode selection switch to change to SET mode.
(Manual operation of the machinery)		Rotate the machinery to the position to be set to zero.
		Press the ADJ switch. Origin compensation will be executed. The absolute angle (electrical angle of the Resolver) will be flashing in the POSITION/OFF display until origin compensation has been completed.
(After origin compensation has been completed)		The original display will appear when origin compensation has been completed. <b>Note</b> If the bank number appears in the Bank/Function display and “0” appears in the Cam/Parameter No. display, the absolute angle for origin compensation will be displayed in the SPEED/ON display.
		Use the mode selection switch to change to RUN mode. The speed display will be “0” and present angle will be “0” if the machinery is not moving.

### Origin Compensation and Origin Shift

- Both origin compensation and origin shift functions match the mechanical origin and the Cam Positioner origin.
- The differences between origin compensation and origin shift are outlined as follows:

#### Origin Compensation

Press the ADJ switch in SET mode to set the present angle at that point to zero. If an origin compensation value has been set, the present angle will change to that origin compensation value. This value (the origin position after compensation for the Resolver's electrical 0°) will not be lost even if the power is turned OFF.

#### Origin Shift

Turn ON the origin shift input (TRIG) in RUN mode to set the present angle at that point to zero. If an origin compensation value has been set, the present angle will change to that origin compensation value. This value will be lost if the power is turned OFF.

- Origin compensation is used to align the mechanical origin and the Cam Positioner origin, for example, when the system is first introduced, when the system is adjusted, or when Resolvers or Cam Positioners are exchanged.  
Origin shift is used during normal operation when the present angle (origin) is to be changed.
- Both origin compensation and origin shift functions are enabled when the Resolver speed is less than 4 r/min. Neither function will be executed when the Resolver speed is 4 r/min or greater.
- The absolute angle will be flashing in the POSITION/OFF display during execution of origin compensation or origin shift.

**Note** When origin compensation values have been set, turn OFF the power supply to the Cam Positioner, turn it ON again and then execute origin compensation or origin shift. The origin compensation value is enabled once the power has been turned ON again. If origin compensation or origin shift are executed without the power being turned OFF and then ON again, the origin compensation or origin shift function will not be executed properly.

### 3-5-6 Start Operation (RUN Mode)

Once origin compensation has been executed, check the operation of the machinery.

#### • Procedure

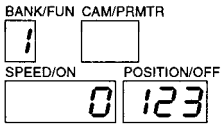
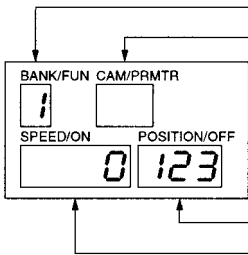
Operation	Display	Explanation
		<p>Use the mode selection switch to change to RUN mode.</p> <p>Bank No. specified at bank selection input (BANK1 to 3)</p> <p>Blank when operation start input signal (START) is OFF.</p>  <p>Present angle</p> <p>Resolver speed (r/min)</p>

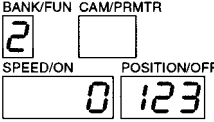
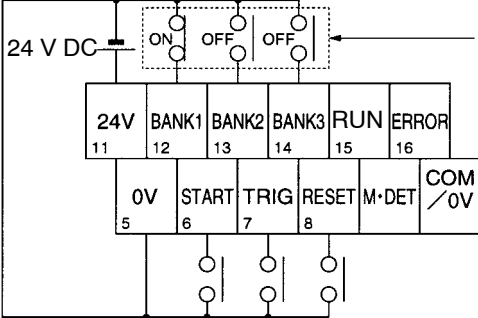
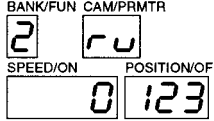
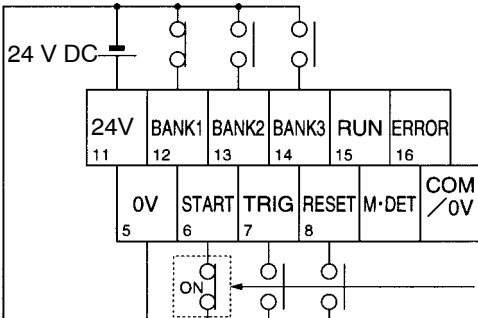
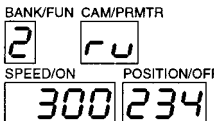
Operation	Display	Explanation
Bank selection input (BANK1 to 3)		<p>Use the control input bank selection input (BANK1 to 3) to specify the bank number to be used.</p>  <p>Set bank number (BANK 1 to 3)                      E.g.: To set bank No. 2:                      BANK 1: ON                      BANK 2: OFF                      BANK 3: OFF</p> <p><b>Note</b> Refer to 3-5-8 Control I/O Signals for information on the relationship between bank selection input (BANK1 to 3) and execution bank numbers.</p>
Operation start input (START)		<p>Turn ON the operation start input signal (START) for control input.</p> <p>When cam output is enabled, the control output RUN output signal (RUN) is turned ON.</p>  <p>Turn ON the operation start signal (START).</p> <p><b>Note</b> When the operation start signal (START) is turned ON, "ru" will appear in the Cam/Parameter No. display.</p>
Machinery operation starts		<p>Start up the machinery and start operation.</p> <p><b>Note</b> Observe the movement of peripheral devices to check if the cam output signals are being output at the correct timing.</p>

**Note** 1. To change the ON and OFF angles, follow the directions in 3-5-3 Cam Program Creating and Checking and change the angle data.

**Note** 2. Use the compensation operation function to change the angle data during operation. Refer to 3-6 Applied Functions for details.

### 3-5-7 I/O Monitor Function (RUN Mode)

The 3F88L-160/162 Cam Positioners have the following monitor functions in RUN mode. If the system does not perform properly at start up, use this monitor function first and check the I/O status.

- Resolver speed and present angle
- Error display
- Cam output status
- Control I/O signal status

#### ■ Resolver Speed and Present Angle Monitoring (RUN Mode)

If the Cam Positioner is set to RUN mode, the Resolver speed (r/min) will be displayed in the SPEED/ON display and the present angle (in 1° units for 360 resolution and 0.5° units for 720 resolution) is displayed in the POSITION/OFF display.

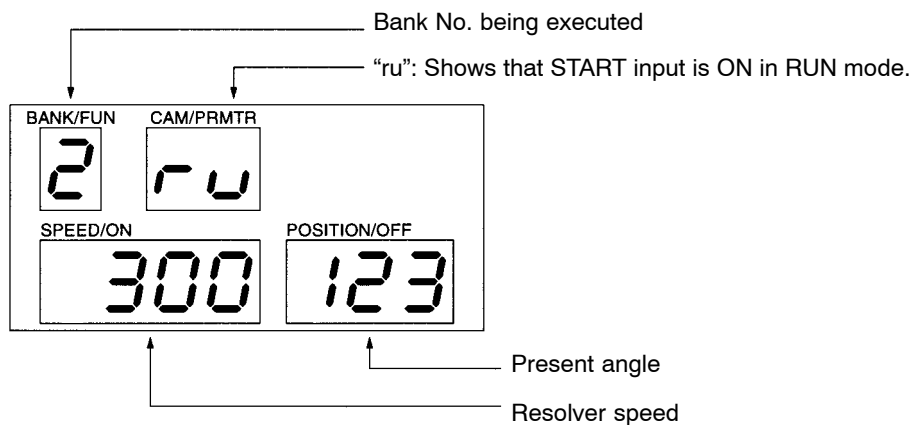

#### ■ Error Display

If an error is generated, an error code (E-\*\*) will appear in the SPEED/ON display.

If an error has been generated, refer to *Chapter 5 Operation* for countermeasures.

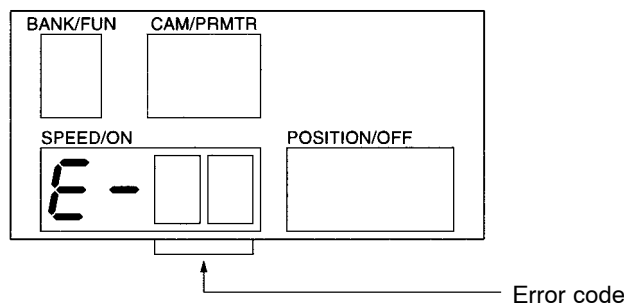







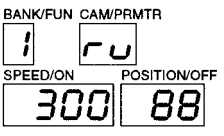

■ Cam Outputs and Control I/O Signal Monitoring (RUN Mode)

Function No.	Parameter No.	Function name	Display
o (%)	1	Cam output monitor	ON/OFF state of cam outputs 1 to 32 (see note) will be displayed by lighting or not lighting each one of the 7-segment indicators (lit when cam is OFF).
	2	Control I/O signal monitor	ON/OFF state of control I/O signals (see note) will be displayed by lighting or not lighting each one of the 7-segment indicators (lit when signal is OFF).

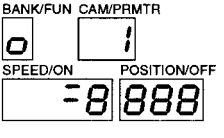
**Note** The 3F88L-160 (16-point model) Cam Positioner does not have cam outputs 17 to 32. (The relevant indicators will remain OFF.)

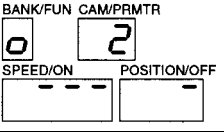
● Procedure

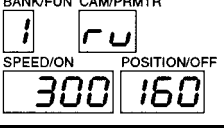
Operation	Display	Explanation
		(Displayed in normal RUN mode.)
		Press the Bank/Function Key. The Bank/Function display will show “0” and the Cam/Parameter No. display will show “1.” The ON/OFF status of cam outputs will be shown in the SPEED/ON and POSITION/OFF displays.
		Press the Cam/Parameter Key. The Cam/Parameter No. display will show “2,” and the ON/OFF status of the control I/O signals will be shown in the SPEED/ON and POSITION/OFF displays.
Keys other than 		Press any key other than the Cam/Parameter Key to return to the display for normal RUN mode.

● Cam Output Monitor Display

• SPEED/ON

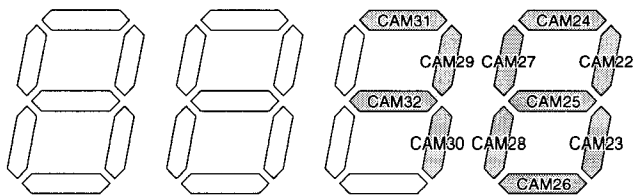

• POSITION/OFF

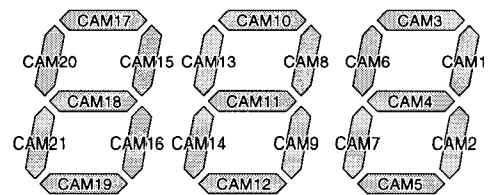

● Control I/O Signal Monitor Display

• SPEED/ON (Control output)

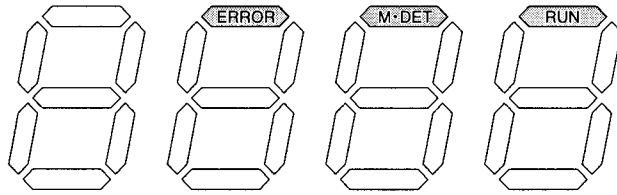

• POSITION/OFF (Control input)

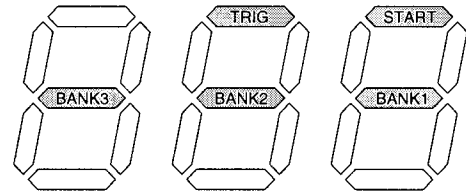

3-5-8 Control I/O Signals

In addition to cam outputs (CAM 1 to 16/CAM 1 to 32), the 3F88L-160/162 Cam Positioners also have the control inputs and outputs described below. Refer to 2-3-3 Terminal Block Wiring for information on wiring control I/O signals.

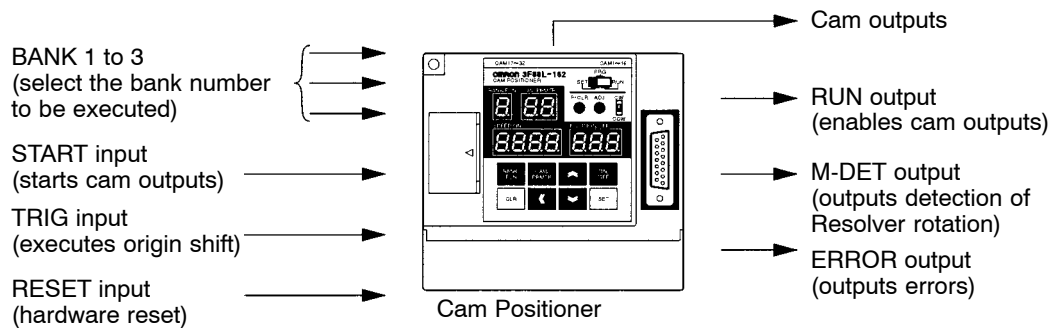

■ Control Inputs

Name	Symbol	Function
Bank selection input	BANK1	Bank selection input selects which Cam Positioner bank number will be executed. Turns ON when this signal is short-circuited with the 0V.
	BANK2	
	BANK3	
Operation start input	START	<p>When the operation start input is turned ON in RUN mode, the operation will start and cam outputs are enabled.</p> <p>When operation start input is turned OFF in RUN mode, cam outputs are disabled.</p> <p><b>Note</b> 1. START input is ignored when the Unit is in modes other than RUN.</p> <p><b>Note</b> 2. Cam outputs will turn ON and OFF during a trial operation in PRGM mode, regardless of the START input status.</p> <p><b>Note</b> 3. Refer to ntl7-2 Performance for information on delay times for cam outputs and RUN outputs after START input is turned ON.</p>

Name	Symbol	Function
Origin shift input	TRIG	<p>When the origin shift input is turned from OFF to ON in RUN mode, origin shift is executed.</p> <p><b>Note</b> 1. TRIG input is ignored when the Unit is in modes other than RUN.</p> <p><b>Note</b> 2. TRIG input is disabled when Resolver speed is 4 r/min or greater.</p> <p><b>Note</b> 3. The TRIG signal is enabled when it has been turned ON for 10 ms or longer.</p> <p><b>Note</b> 4. Refer to 7-2 <i>Performance</i> for information on the relationship between TRIG inputs, RUN outputs, and cam outputs.</p>
Reset input	RESET	<p>Regardless of the current operation mode, hardware reset is performed when the reset input is turned ON and the system will return to the startup status.</p> <p><b>Note</b> 1. All outputs will turn OFF, regardless of the output hold settings.</p> <p><b>Note</b> 2. The origin values retained for origin shift will be lost.</p>

■ Control Outputs

Name	Symbol	Function
RUN output	RUN	<p>ON: Cam outputs enabled OFF: Cam outputs disabled</p> <p>In any of the following circumstances, cam outputs will be enabled if no errors have been generated.</p> <ul style="list-style-type: none"> <li>• When the START signal is ON in RUN mode (including during compensation operation)</li> <li>• When the trial operation function is started in PRGM mode.</li> </ul> <p>Cam outputs will be disabled under any of the following circumstances.</p> <ul style="list-style-type: none"> <li>• When the START signal is OFF in RUN mode.</li> <li>• When an error has been generated (error code E-** or a watchdog error). (Refer to 5-1 <i>Diagnosis using Error Codes</i>.)</li> <li>• When changing from RUN to PRGM mode or from RUN to SET mode.</li> <li>• When the trial operation function is completed in PRGM mode.</li> </ul> <p><b>Note</b> Refer to 7-2 <i>Performance</i> for information on ON and OFF delay times for RUN outputs.</p>
Resolver rotation detection output	M-DET	<p>ON: When Resolver speed is 4 r/min or greater OFF: When Resolver speed is less than 4 r/min or an error has been generated. (Refer to 5-1 <i>Diagnosis using Error Codes</i>.)</p> <p><b>Note</b> Refer to 7-2 <i>Performance</i> for information on ON and OFF delay times when the Resolver speed is 4 r/min or greater.</p>
Error output	ERROR	<p>ON: While error code E-** or watchdog errors have not been generated. OFF: When an error code E-** or watchdog error has been generated (Refer to 5-1 <i>Diagnosis using Error Codes</i>). Alternatively, during initialization when the power is turned ON. (Refer to 7-2 <i>Performance</i> for information on initialization times.)</p>

### 3-6 Applied Functions

Function selection (Function No. U) must be set to “2” (all functions) before the applied functions can be used for 3F88L-160/162 Cam Positioners.

#### 3-6-1 Function Level Selection Setting (SET Mode)

##### ■ Function Level Selection Setting and Checking







Check if the function level is set to function level 2 (all functions). If another function level is set, change the setting to function level 2 (all functions).

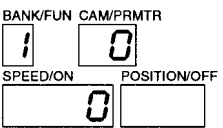

Function level 0 1 2

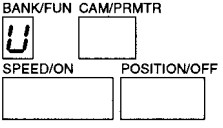
Function No.	Parameter No.	Function name	Setting range	Details
U (u)	1	Function level selection	0 to 2	0: Function level 0 (monitor only) 1: Function level 1 (basic operation/monitor only) (factory setting) 2: Function level 2 (all functions)

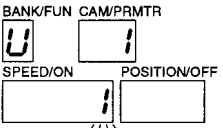
##### ● Procedure

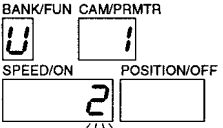
Set the function level selection to “2” (function level 2).

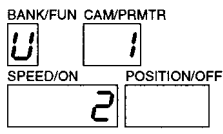
Operation	Display	Explanation
		Use the mode selection switch to change to SET mode.
		Keep pressing the Bank/Function Key until “U” appears on the display. <b>Note</b> The display will change from 1→2→...→8→A→t→U→1→.. in the basic settings.
		Press the Set Key to allow settings to be made. • Cam/Parameter number display: “1” • SPEED/ON angle display: Flashes current setting
		If the setting value is not “2,” use the Up Key and change the setting to “2” (all functions). 0: Monitor    1: Basic settings    2: All functions If the setting is not on “2,” use the Up or Down Key to change to “2” (all functions). 0: Monitor 1: Basic settings 2: All functions

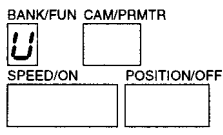
Operation	Display	Explanation
		Press the Set Key to confirm the settings. The setting will stop flashing for approximately 1 second and then resume flashing. <b>Note</b> When a setting is flashing, the Up and Down Keys are enabled and the setting may be changed.
		Press the Bank/Function Key. The display will return to only the function number that appears. Turn OFF the power supply. (The settings will now be enabled.)

**Note 1.** The functions are enabled once the power has been turned OFF and then ON again.

**Note 2.** The display will change as shown below when the Bank/Function Key is pressed repeatedly to set the function number.

Function level 0: 1→2→3→4→5→6→7→8→U→1→etc.

Function level 1: 1→2→3→4→5→6→7→8→A→t→U→1→etc.

Function level 2: 1→2→3→4→5→6→7→8→A→b→C→d→F→H→P→t→U→1→etc.

If the resolution selection (explained in the next section) is set to “1” (720 divisions/rotation), “5→6→7→8” will not be displayed.

### 3-6-2 Parameter List (SET Mode)

Bank/Function	Cam/Parameter	Function name	Setting range	SPEED/ON	POSITION/OFF
1 to 8 (1 to 4) (see note 2)	0	Origin compensation absolute angle	---	Displays the absolute angle for origin compensation (display only, no settings can be made).	---
	1 to 32 (1 to 16) (see note 1)	Program number checking	---	Displays the number of steps for the displayed bank or cam number (display only, no settings can be made).	---
A (a)	1	Resolution selection	0, 1	0: 360 divisions/revolution (factory setting) 1: 720 divisions/revolution	---

Bank/Function	Cam/Parameter	Function name	Setting range	SPEED/ON	POSITION/OFF
b (b)	1	Origin compensation value	0 to 359 (0 to 719) (see note 2)	Sets origin compensation value (angle data). Factory setting "0."	---
	2	Backlash compensation value	0 to 179 (0 to 359) (see note 2)	Sets backlash compensation value (angle data). Factory setting "0."	---
	3	Advance angle compensation value 1	0 to 1600 (0 to 800) (see note 2)	Sets speed data for advance angle compensation value 1. Factory setting "0."	---
			0 to 359 (0 to 719) (see note 2)	---	Sets angle data for advance angle compensation value 1. Factory setting "0."
	4	Advance angle compensation value 2	0 to 1600 (0 to 800) (see note 2)	Sets speed data for advance angle compensation value 2. Factory setting "0."	---
			0 to 359 (0 to 719) (see note 2)	---	Sets angle data for advance angle value 2. Factory setting "0."
	5	Advance angle compensation value 3	0 to 359 (0 to 719) (see note 2)	---	Sets angle data for advance angle compensation value 3 (advance angle compensated position). Factory setting "0."
6	Baud rate	1, 2	1: 9,600 bps (factory setting) 2: 19,200 bps	---	
c (c)	---	Cam protect	---	Protection can be set or released for each cam number or for all cams in a bank number. (Factory setting: "unprotected")	Protect can be set or released for each cam number or for all cams in a bank number (Factory setting "unprotected")
d (d)	---	Teaching	---	Present Resolver angle can be input as ON angle data.	Present Resolver angle can be input as OFF angle data.

Bank/Function	Cam/Parameter	Function name	Setting range	SPEED/ON	POSITION/OFF
F (f)	---	One-direction function setting	0 to 2	---	0: One-direction function disabled (factory setting) 1: Enabled in forward direction 2: Enabled in reverse direction
H (h)	1	Backlash compensation enable/disable setting	0, 1	0: Backlash compensation disabled (factory setting) 1: Backlash compensation enabled	---
	2	Advance angle compensation enable/disable setting	0, 1	0: Advance angle compensation disabled (factory setting) 1: Advance angle compensation enabled	---
	3	Output hold	0, 1	0: Output hold disabled (factory setting) 1: Output hold enabled	---
	4	Present value output setting	0 to 4	0: No present value output function (factory setting) 1: 4-digit present angle (no units) 2: 4-digit number of rotations (no units) 3: Automatic switching of 3-digit present angle and number of rotations (with units) 4: Automatic switching of 4-digit present angle and number of rotations (with units)	---

Bank/Function	Cam/Parameter	Function name	Setting range	SPEED/ON	POSITION/OFF
P (p) (see note 4)	---	Pulse output setting	---	Writes pulse output program to any bank or cam number (sets pulse number).	(Sets pulse start position.)
t (t) (see note 4)	0	Data transfer (Slave setting)	---	(Operates on a command issued from Master Unit)	---
	1	Data transfer (Master setting)	0 to 3	0: Disabled (factory setting) 1: Read data 2: Write data 3: Verify data	---
U (u)	1	Function level selection	0 to 2	0: Function level 0 (monitor only) 1: Function level 1 (basic operation/monitor only) (factory setting) 2: Function level 2 (all functions)	---

**Note 1.** The data for the 3F88L-160 (16-point model) Cam Positioner is shown in parentheses.

**Note 2.** The data for 720 resolution (divisions/revolution) is shown in parentheses. The angles will be set and displayed as “1” for 0.5°.

**Note 3.** Functions A, b, C, F, H, and U will be enabled after the power has been turned OFF and then ON again.

**Note 4.** Functions P and t are special operations that are not stored as parameters.



### 3-6-3 Parameter Explanation and Operation

#### ■ Explanation

In this section, individual parameters will be explained in the following format.

Parameter name		Function level setting	
● <b>Origin Compensation Value</b>		Function level	2
<b>Function No.</b>	b (b)	<b>Parameter No.</b>	1
		<b>Setting range</b>	0 to 359 (0 to 719) (see note 1)
• (Function explanation) <b>Note</b> (Additional information)			

#### • Parameter Name

Parameter names such as “origin compensation value” and “backlash compensation value” will appear here.

#### • Function Level Setting

The function level at which this parameter can be set will appear here.

In the above example, this parameter can be set at function level 2 (all functions) only.

#### • Function No.

The function number of this parameter will appear here.

The 7-segment indicator display will appear in parentheses after function numbers that appear as letters (rather than numerals).

#### • Parameter No.

The parameter number for this parameter will appear here.

#### • Setting Range

The setting range for this parameter will appear here.

#### • Function Explanation

The functions and factory settings for this parameter will be explained here.

#### • Additional Information

Additional information for items with “See note” as well as information on restrictions or cautions pertaining to the use of that function will appear here.

#### ■ Items to be Checked before Setting Parameters

The functions and parameter setting for 3F88L-160/162 Cam Positioners will be explained in the next section. Before proceeding, be sure to check that the following two settings have been made.

- Set the function level (Function No. U) to “2” (function level 2).
- Set the resolution selection (Function No. A) to the resolution to be used.

Once these settings have been made, turn OFF the Cam Positioner and then turn it ON again.

If additional parameters are set without the power being turned OFF and then ON again, the function levels and resolution selections will not be enabled and the parameters, therefore, will not be set properly.

■ Operation

The method for basic parameter display and settings is shown in the following diagram.

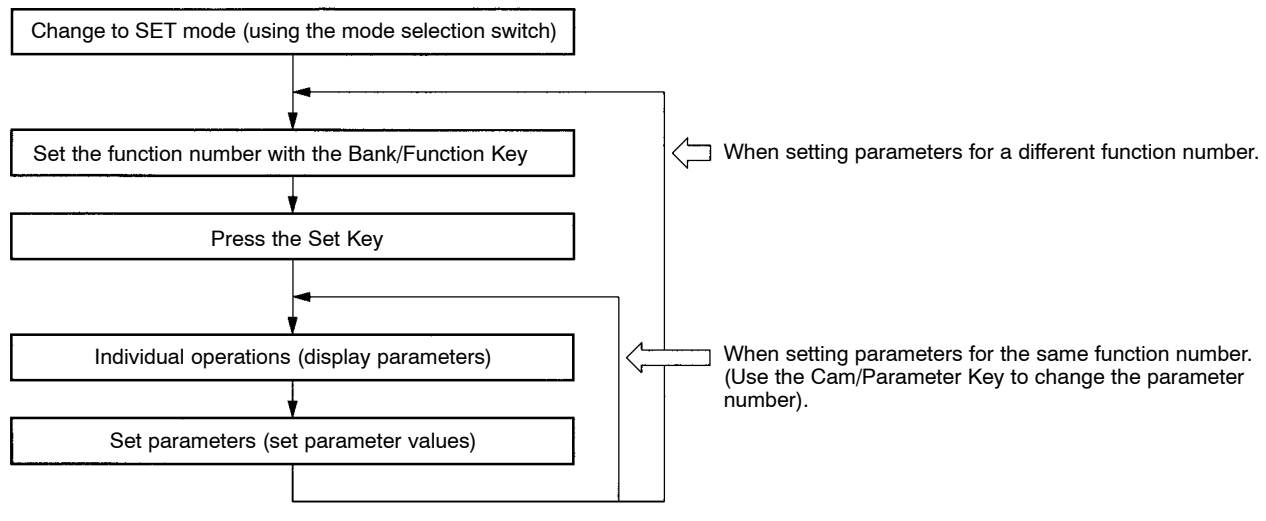

● Individual Operations

Individual operations differ for each parameter. A status flowchart, like the one shown below, will be shown for each parameter in each section.

The following example shows the status flowchart when displaying function No. b parameters.

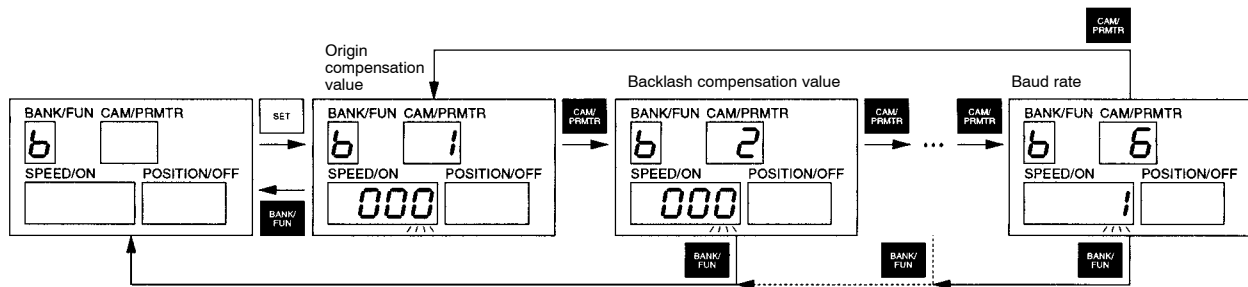

**Note** Set the function number (use the Bank/Function Key to change the function number and press the Set Key), display the parameter numbers, and then use the Cam/Parameter Key to set the parameter numbers (for functions with multiple parameter numbers). The parameter number will increase each time the Cam/Parameter Key is pressed. If the Cam/Parameter Key is pressed on the last parameter number (parameter number 6 in the above example), the display will return to parameter number 1.

**● Setting Parameters**

Once the parameters have been displayed using the individual operations, perform the following operations to set the parameter data.

- Use the Up and Down Keys to increase or decrease the numeric value of the digit that is flashing.
- Press the Forward Key to shift to the next digit to the left. If the Forward Key is pressed while the leftmost digit is flashing, the rightmost digit will start flashing.
- If a parameter has two items to be set (e.g., advance angle compensation value 1), the data will be displayed in the SPEED/ON and POSITION/OFF displays.
- As the final step, press the Set Key to confirm the settings. When the Set Key is pressed, the data will remain lit for approximately one second and then one of the digits will start flashing again.

■ Display Changes in SET Mode

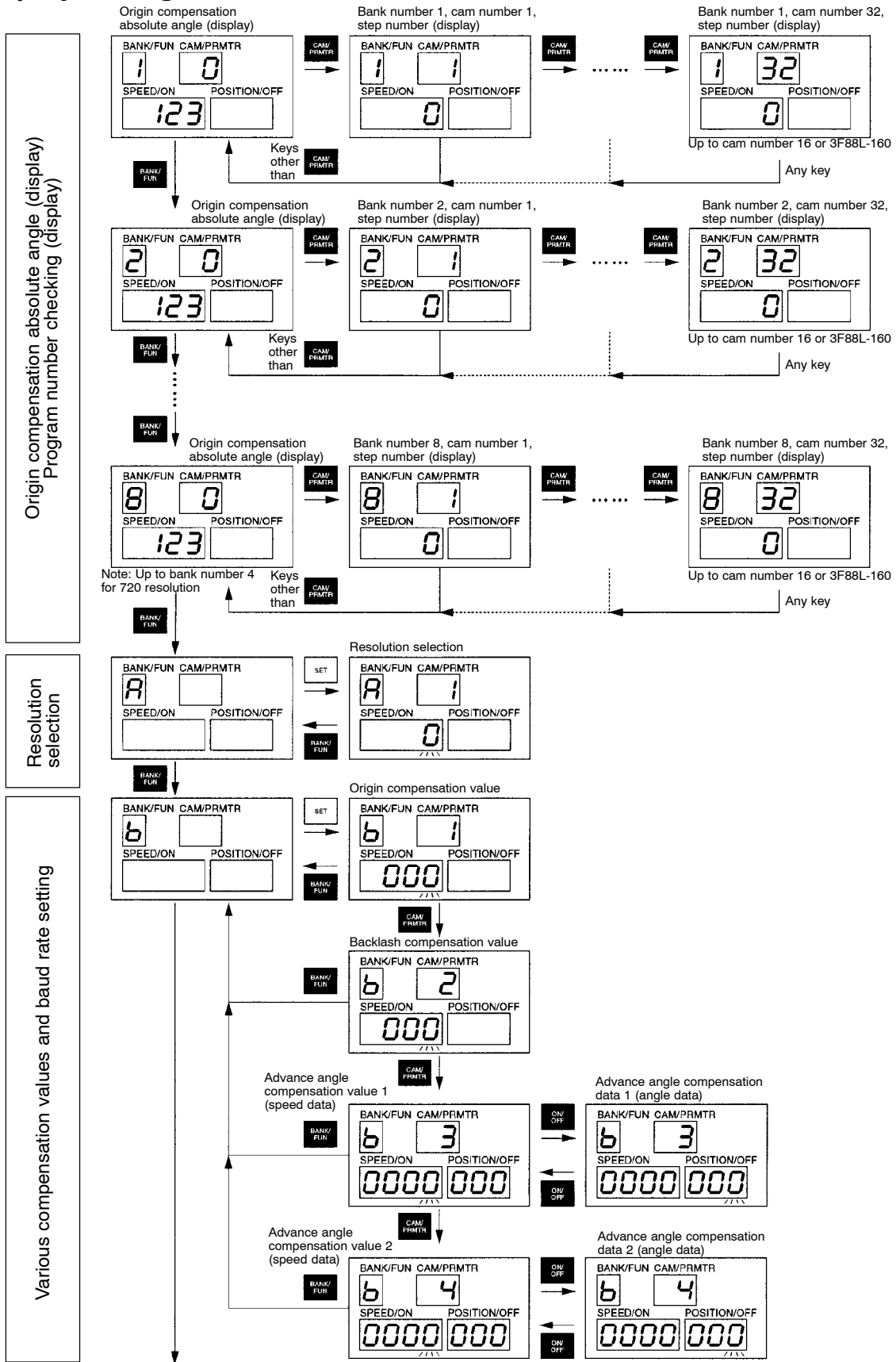

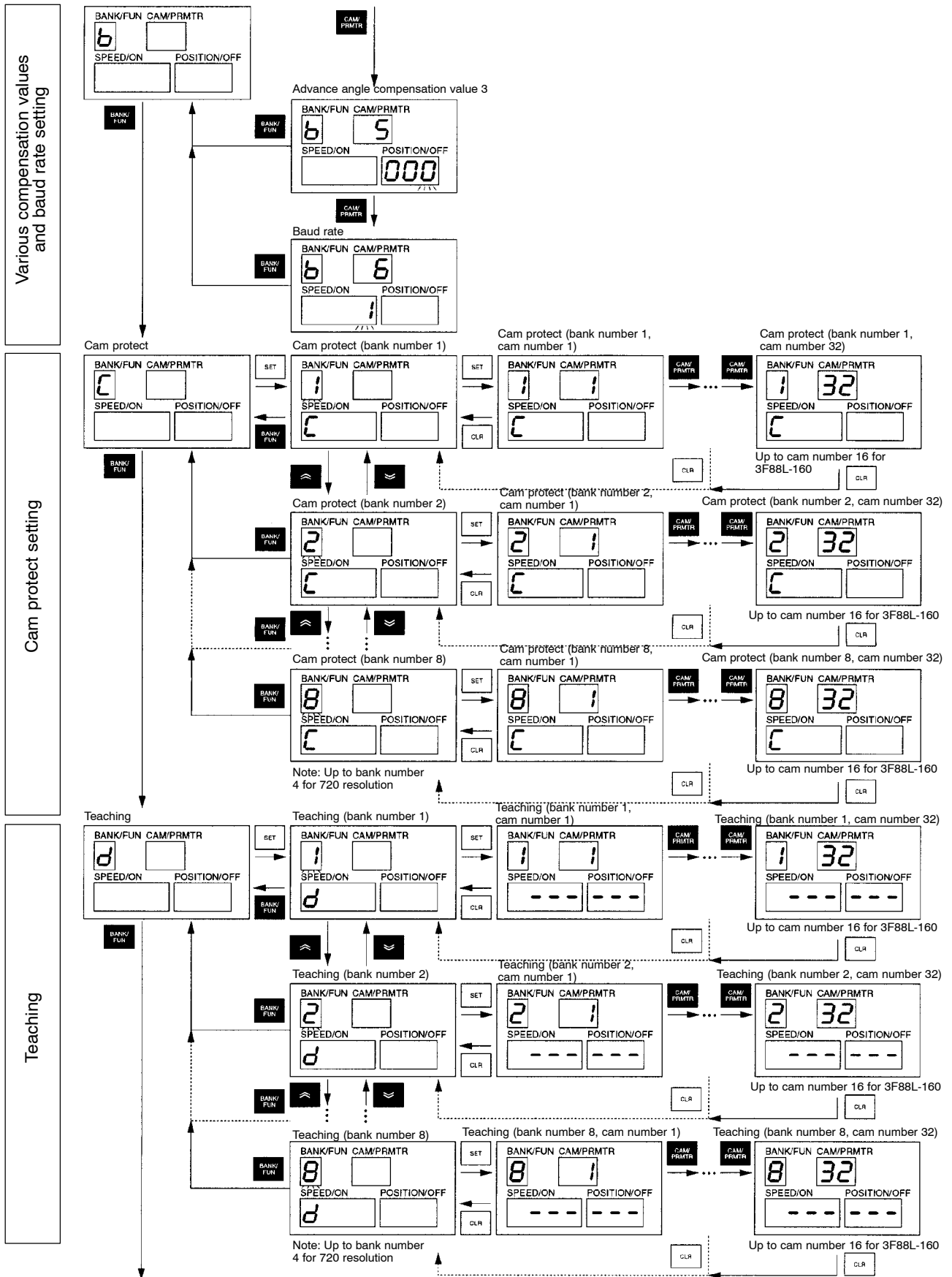

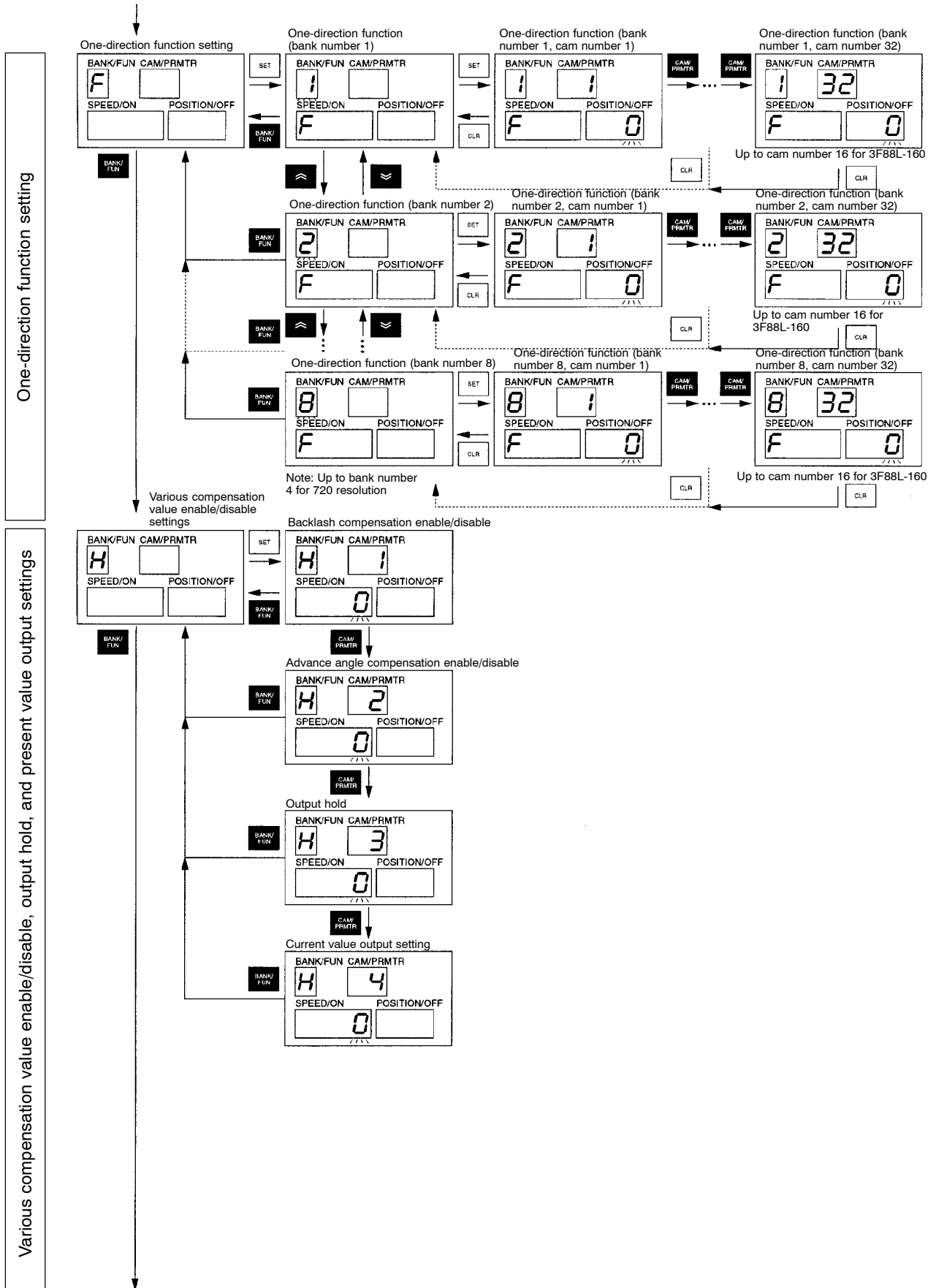

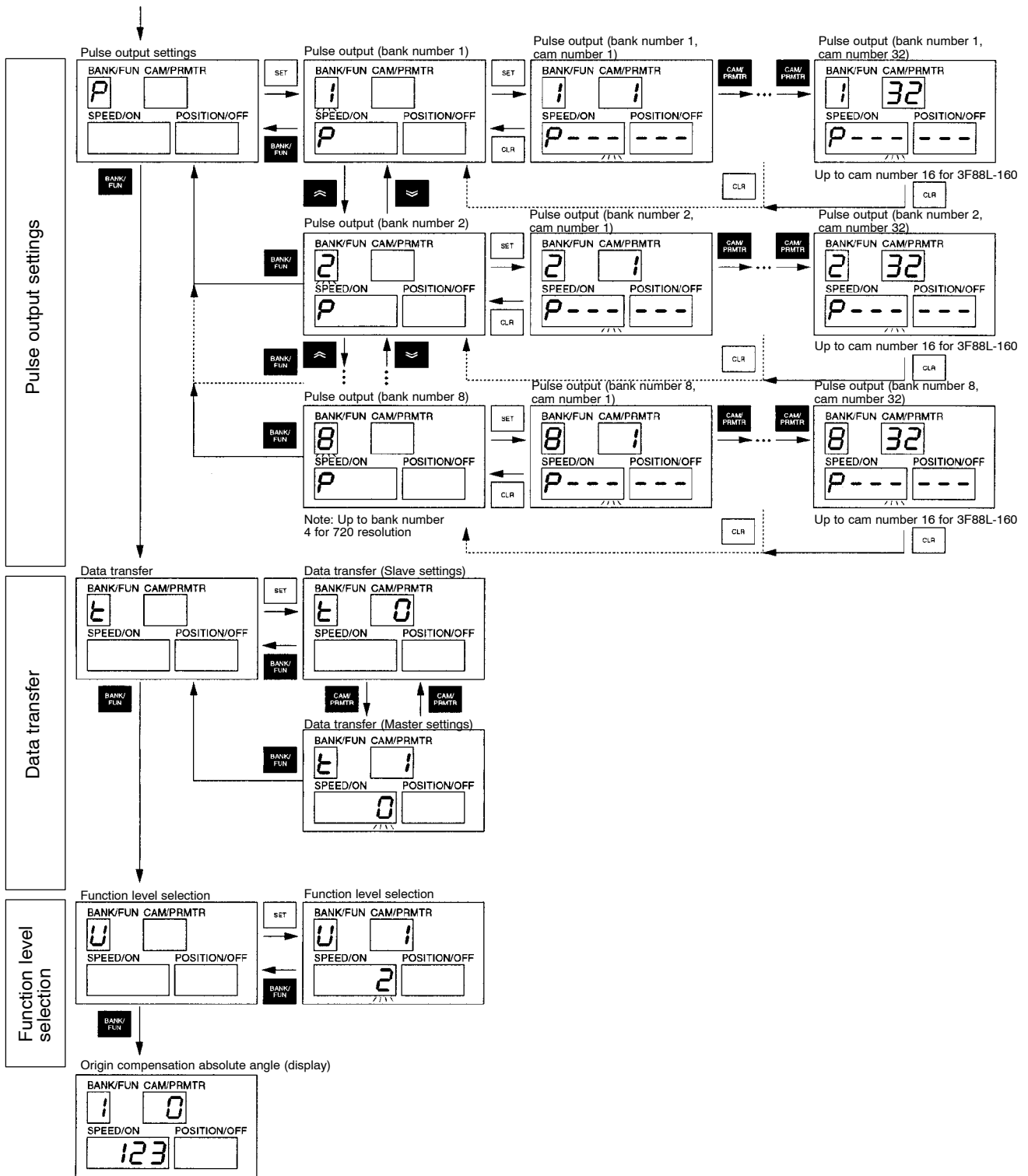

### 3-6-4 Origin Compensation and Origin Shift

#### ■ Functions

- Both origin compensation and origin shift functions match the mechanical origin and the Cam Positioner origin.
- The differences between origin compensation and origin shift are outlined as follows:

##### Origin Compensation

Press the ADJ switch in SET mode to set the present angle at that point to zero. If an origin compensation value has been set, the present angle will change to that origin compensation value. This value (the origin position after compensation for the Resolver's electrical 0°) will not be lost even if the power is turned OFF.

##### Origin Shift

Turn ON the origin shift input (TRIG) in RUN mode to set the present angle at that point to zero. If an origin compensation value has been set, the present angle will change to that origin compensation value. This value will be lost if the power is turned OFF.

- Origin compensation is used to align the mechanical origin and the Cam Positioner origin, for example, when the system is first introduced, when the system is adjusted, or when Resolvers or Cam Positioners are exchanged.

Origin shift is used during normal operation when the present angle (origin) is to be changed.

- Both origin compensation and origin shift functions are enabled when the Resolver speed is less than 4 r/min. Neither function will be executed when the Resolver speed is 4 r/min or greater.
- The absolute angle will be flashing in the POSITION/OFF display during execution of origin compensation or origin shift.

**Note 1.** When origin compensation values have been set, turn OFF the power supply to the Cam Positioner, turn it ON again and then execute origin compensation or origin shift. The origin compensation value is enabled once the power has been turned ON again. If origin compensation or origin shift are executed without the power being turned OFF and then ON again, the origin compensation or origin shift function will not be executed properly.

**Note 2.** When origin shift has been used to change the origin position, the origin position value will be lost when the power is turned OFF. The present angle after the power is turned ON again will, therefore, be different from the present angle before the power was turned OFF and the cam output timing will be out of synch. When using origin shift, stop the machinery and turn ON the power supply while the START input is OFF. Execute origin shift at the correct position and then turn ON the START input and start the machinery operation.

#### ■ Example Operation

- When the origin compensation value is "0" (resolution: 360)

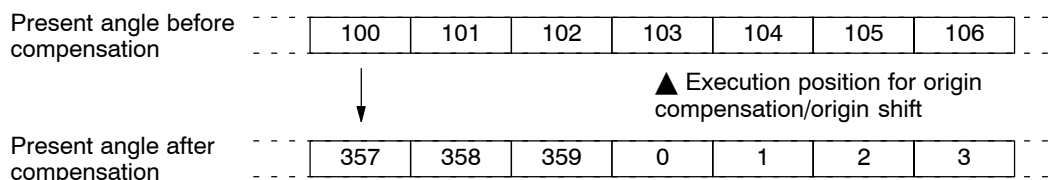



- When the origin compensation value is “200” (resolution: 360)

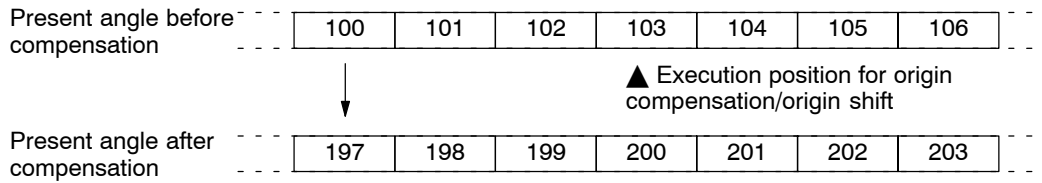

### ■ Related Parameters (SET Mode)

#### ● Origin Compensation Value

Function level 2

Function No.	b (b)	Parameter No.	1	Setting range	0 to 359 (0 to 719) (see note 1)
--------------	-------	---------------	---	---------------	----------------------------------

- Use this parameter to set the present angle for when origin compensation or origin shift function is executed.
- If this value is set to “0” (factory setting), the present angle will change to the origin (0°) when the origin compensation or origin shift function is executed.

**Note 1.** The numeric values for 720 (divisions/rotation) resolution are shown in parentheses.

**Note 2.** This parameter is enabled when the power is turned OFF and then turned ON again.

### Operation

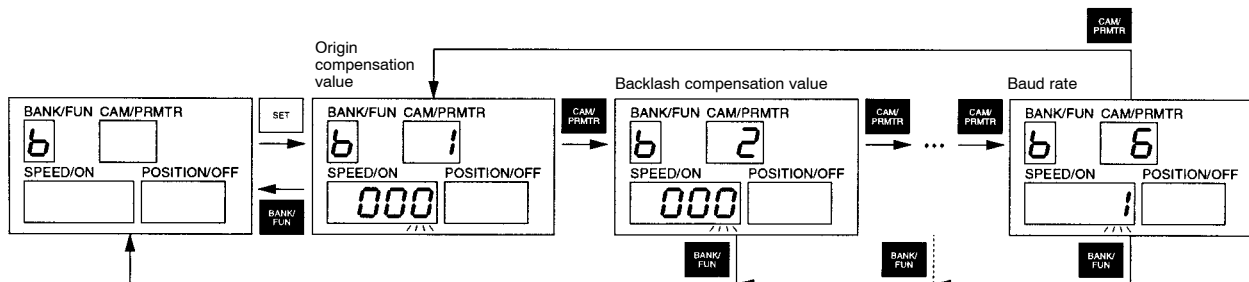
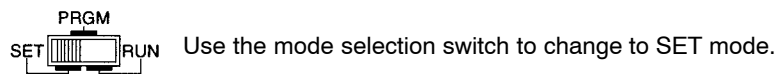

- When the origin compensation value (Function No. b, Parameter No. 1) is displayed, the present setting will be displayed in the SPEED/ON display and the first digit (rightmost digit) will flash.
- Use the Forward, Up, and Down Keys to change the data.
- Press the Set Key and the data will remain lit for approximately one second, the setting will be confirmed, and the display will resume flashing.
- If the data is inappropriate and the Set Key is pressed, all displays will flash twice and then return to the settings before the data was edited. Re-input the correct data.
- Press the Clear Key to return the data to the factory settings. If the Clear Key is pressed, the three digits of data will start flashing. Press the Set Key while the data is flashing and the display will change to “— — —” and the factory settings will be restored. If the Clear Key is pressed again while the three digits of data are flashing, the data will not be initialized and the display will return to the edited state.

● Origin Compensation Absolute Angle (Display)

Function level 0 1 2

<b>Function No.</b>	1 to 8 (1 to 4) (see note)	<b>Parameter No.</b>	0	<b>Setting range</b>	(Display only)
---------------------	-------------------------------	----------------------	---	----------------------	----------------

- Use this parameter to display the origin compensation absolute angle (origin position after origin compensation or origin shift for the Resolver’s electrical 0°) in the SPEED/ON display.
- If the parameter number is “0,” the same numeric value will be displayed, regardless of the function number (1 to 8 or 1 to 4).

**Note** The numeric values for 720 (divisions/rotation) resolution are shown in parentheses.

Operation

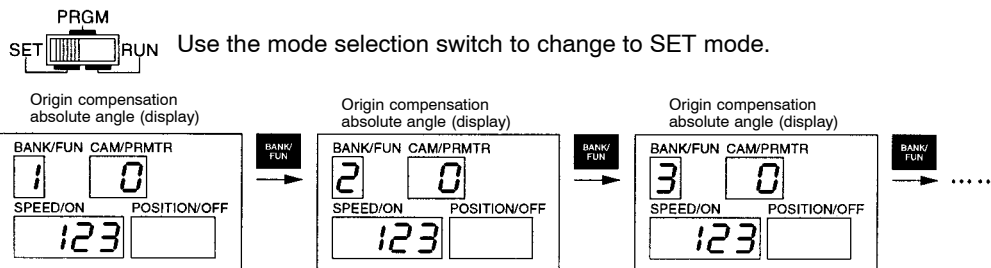

■ Origin Compensation Execution (SET Mode)

● Procedure

Operation	Display	Explanation
		Use the mode selection switch to change to SET mode.
(Manual operation of the machinery)		Rotate the machinery to the position to be set to zero.
		Press the ADJ switch. Origin compensation will be executed. The absolute angle (electrical angle of the Resolver) will be flashing in the POSITION/OFF display until origin compensation has been completed.
(After origin compensation has been completed)		The original display will appear when origin compensation has been completed. <b>Note</b> If the bank number appears in the Bank/Function display and “0” appears in the Cam/Parameter No. display, the absolute angle for origin compensation will be displayed in the SPEED/ON display.
		Use the mode selection switch to change to RUN mode. The speed display will be “0” and present angle will be “0” if the machinery is not operating.

■ Origin Shift Execution (RUN Mode)

● Procedure

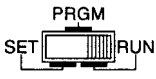
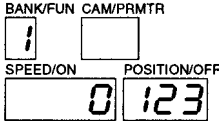
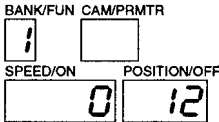
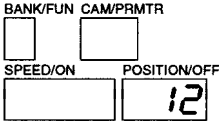
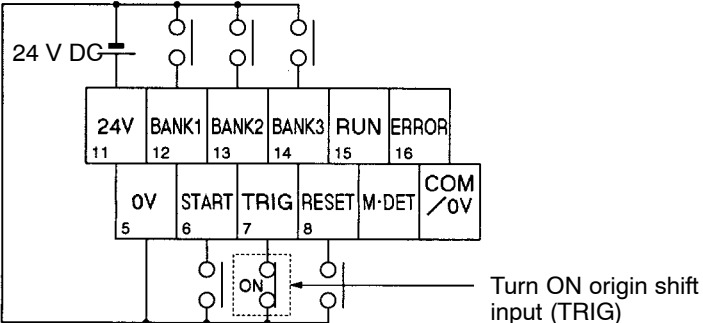
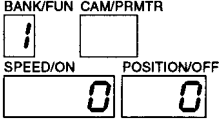
Operation	Display	Explanation
		<p>Use the mode selection switch to change to RUN mode.</p>
<p>(Manual operation of the machinery)</p>		<p>Rotate the machinery to the position to be set as zero (or to the origin compensation value).</p>
<p>Origin shift input (TRIG)</p>		<p>Turn ON the origin shift input (TRIG) to execute origin shift. The absolute angle (Resolver's electrical angle) will flash in the POSITION/OFF display until origin shift has been completed.</p> 
<p>(After origin shift has been completed)</p>		<p>The original display will appear when origin shift has been completed. The speed display will be "0" and present angle will be "0" if the machinery is not operating.</p>

### 3-6-5 Backlash Compensation

#### ■ Functions

- The backlash compensation function absorbs mechanical looseness by creating a gap between the detection angles in the CW and CCW directions.
- If a compensation value equivalent to the mechanical looseness is set, the cam outputs can match the mechanical position.
- This function is effective for machinery that rotate in both directions. Backlash compensation is not required for machinery that rotates in one direction only.
- If backlash compensation values are set, the display will not change until the machine has rotated in the opposite direction through a number of degrees for the backlash compensation amount.
- The backlash compensation function operates when the “backlash compensation enable/disable” parameter is set to “enable.”

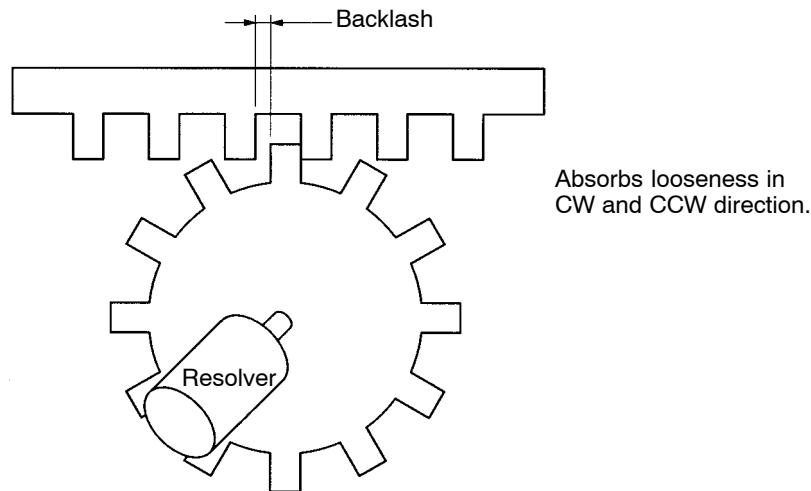

#### ■ Related Parameters (SET Mode)

##### ● Backlash Compensation Value

Function level 2

<b>Function No.</b>	b (b)	<b>Parameter No.</b>	2	<b>Setting range</b>	0 to 179 (0 to 359) (see note 1)
---------------------	-------	----------------------	---	----------------------	----------------------------------

- Use this parameter to set the angle equivalent to the mechanical looseness (backlash).
- The factory setting is “0.”

**Note 1.** The numeric values for 720 (divisions/rotation) resolution are shown in parentheses.

**Note 2.** This parameter is enabled when the power is turned OFF and then turned ON again.

Operation

PRGM  
 SET  RUN Use the mode selection switch to change to SET mode.

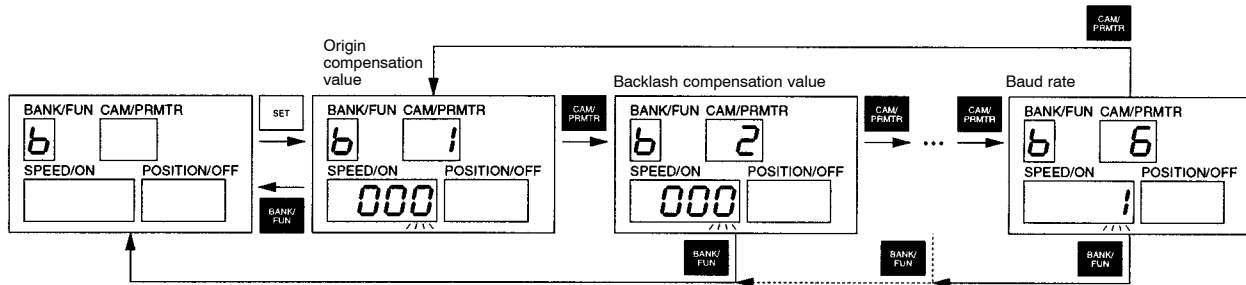

- When the backlash compensation value (Function No. b, Parameter No. 2) is displayed, the present setting will be displayed in the SPEED/ON display and the first digit (rightmost digit) will flash.
- Use the Forward, Up, and Down Keys to change the data.
- Press the Set Key and the data will remain lit for approximately one second, the setting will be confirmed, and the display will resume flashing.
- If the data is inappropriate and the Set Key is pressed, all displays will flash twice and then return to the settings before the data was edited. Re-input the correct data.
- Press the Clear Key to return the data to the factory settings. If the Clear Key is pressed, the three digits of data will start flashing. Press the Set Key while the data is flashing and the display will change to “— — —” and the factory settings will be restored. If the Clear Key is pressed again while the three digits of data are flashing, the data will not be initialized and the display will return to the edited state.

• Backlash Compensation Enable/Disable

Function level 2

Function No.	H (h)	Parameter No.	1	Setting range	0, 1
--------------	-------	---------------	---	---------------	------

- Set this parameter to “1” to enable backlash compensation. (0: backlash compensation disabled; 1: backlash compensation enabled)
- The factory setting is “0.”

**Note** This parameter is enabled when the power is turned OFF and then turned ON again.

Operation

PRGM  
 SET  RUN Use the mode selection switch to change to SET mode.

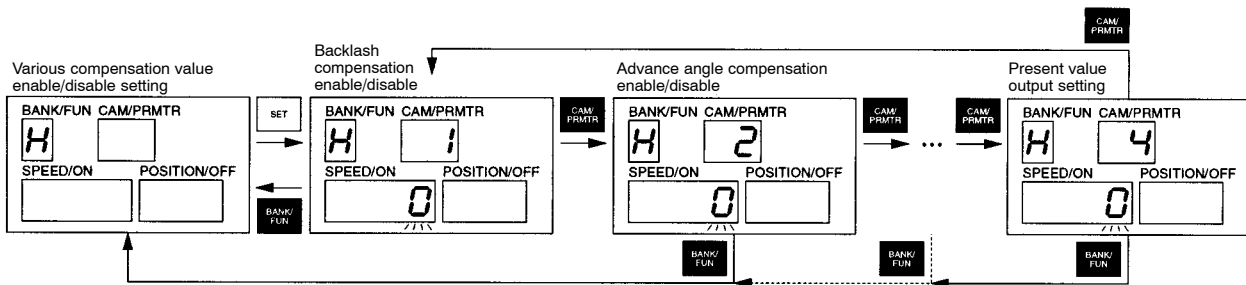

- When the backlash compensation enable/disable setting (Function No. H, Parameter No. 1) is displayed, the current settings will be flashing in the SPEED/ON display.
- Use the Up and Down Keys to change the data.
- When the Set Key is pressed, the data will remain lit for approximately one second, the setting will be confirmed, and then the data will resume flashing.

### 3-6-6 Advance Angle Compensation

#### ■ Functions

- The advance angle compensation function advances the ON and OFF angles for all cams in proportion to the speed of the Resolver.
- When cam output signals are used to move peripheral devices, this function is used to adjust the timing of peripheral device movement. This function can also be used to minimize angle deviation caused by a delay in signal transmission.
- There are three advance angle compensation parameters for 3F88L-160/162 Cam Positioners.
  - Advance angle compensation value 1: Speed and angle data settings
  - Advance angle compensation value 2: Speed and angle data settings
  - Advance angle compensation value 3: Angle data settings for advance angle compensation position

The relationship between the Resolver speed and advance angle is set in the first two parameters, advance angle compensation values 1 and 2. The third parameter, advance angle compensation value 3 indicates the position where the advance angle is to be changed. (For example, if the advance angle amount changes from 0° to 1°, the angle must be increased by 1° somewhere in the rotation. This parameter designates the position for that increase.)
- The advance angle compensation function operates when the “advance angle compensation enable/disable setting” parameter is set to “enable.”

● **Timing Compensation Example**

- This example shows a peripheral device (cylinder) operating on workpieces on a conveyor belt. In this application, the Resolver is mounted on the drive axle of the conveyor and the drive signal for the cylinder is output by the Cam Positioner.

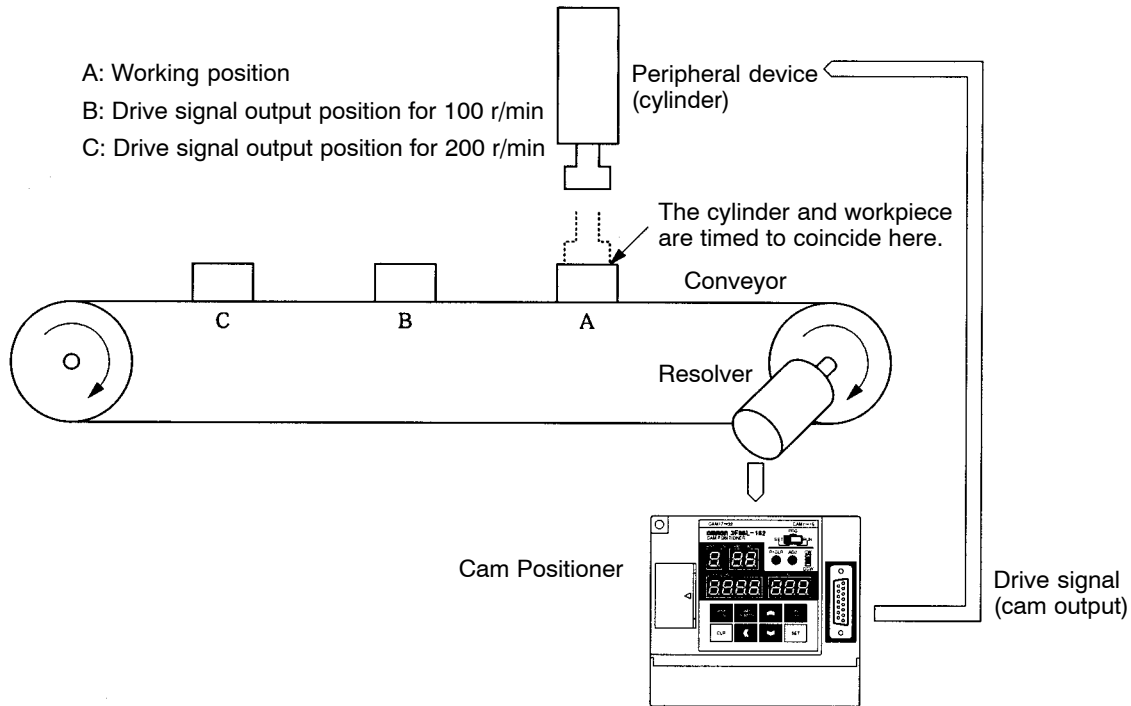

- The position where work is performed by the cylinder on the workpiece is indicated by A. If the conveyor is moving and the drive signal (cam output) is output when the workpiece has arrived at position A, the workpiece will have already left that position when the cylinder descends. Therefore, the drive signal must be output at an earlier point. That point is determined by the speed of the conveyor and the cylinder descending time. If the conveyor speed is high, the drive speed must be output earlier. For example, if the drive signal output position for a Resolver speed of 100 r/min is B, then the drive signal output position will be C for a speed of 200 r/min.
- If the cylinder descending time is constant, the distance between the drive signal output position and the work position A will be proportional to the Resolver speed. This proportional relationship is set as an advance angle compensation parameter and enables the cylinder descending time and the arrival of the workpiece to coincide, regardless of the conveyor speed (Resolver speed).

- A setting example is shown in the following diagram.

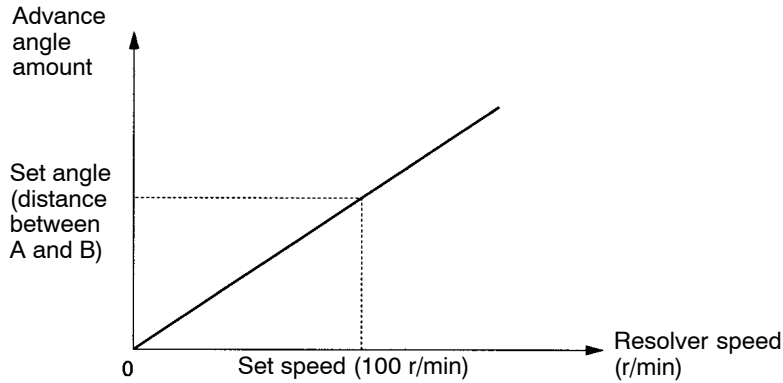

**Note** For example, set the speed to 100 r/min and set a Resolver angle corresponding to the distance between A and B as the set angle.

- For example, if the advance angle amount is 5° for 100 r/min (when the distance between A and B corresponds to a Resolver angle of 5°), the advance angle compensation will be as shown below.

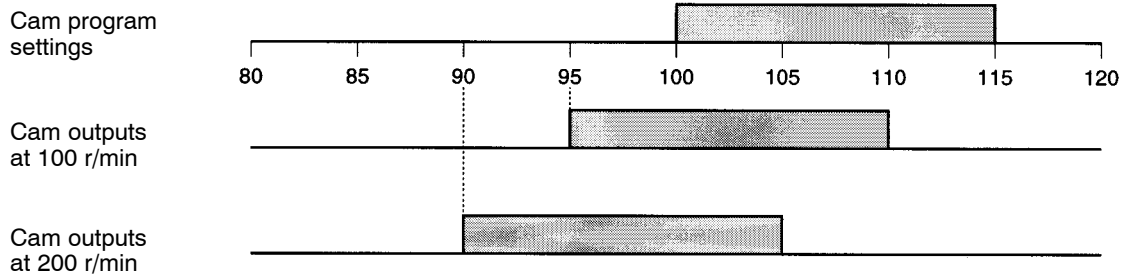

**When advance angle compensation value 1 is set.**

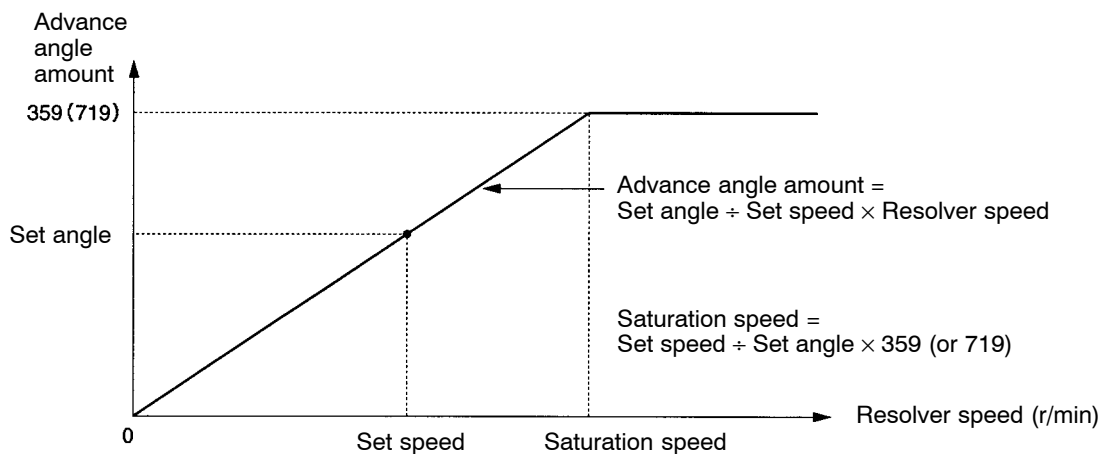

**Note** The maximum compensation value is 359 (for 360 resolution) or 719 (for 720 resolution). compensation greater than one rotation cannot be made.



**When advance angle compensation values 1 and 2 are set.**

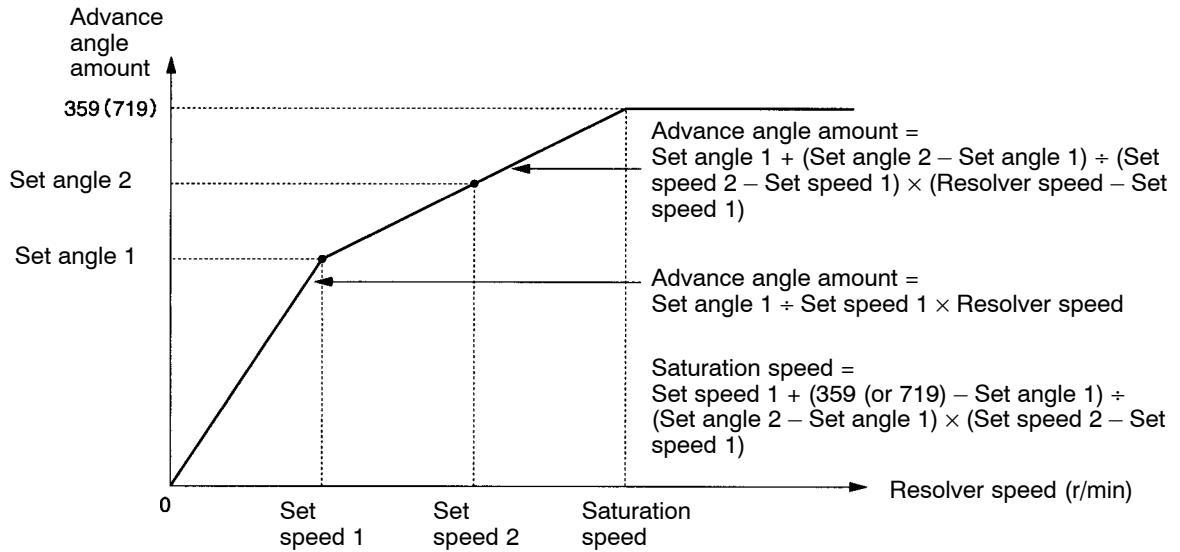

**Note 1.** The data for advance angle compensation value with the lower speed (out of advance angle compensation values 1 and 2) will become the set speed 1 and the set angle 1.

**Note 2.** The maximum compensation value is 359 (for 360 resolution) or 719 (for 720 resolution). A compensation greater than one rotation cannot be made.

**Note 3.** Except for 0, the same speed data cannot be set for advance angle compensation values 1 and 2.

**When advance angle compensation values 1 and 2 are set and the set angle 2 is smaller than the set angle 1.**

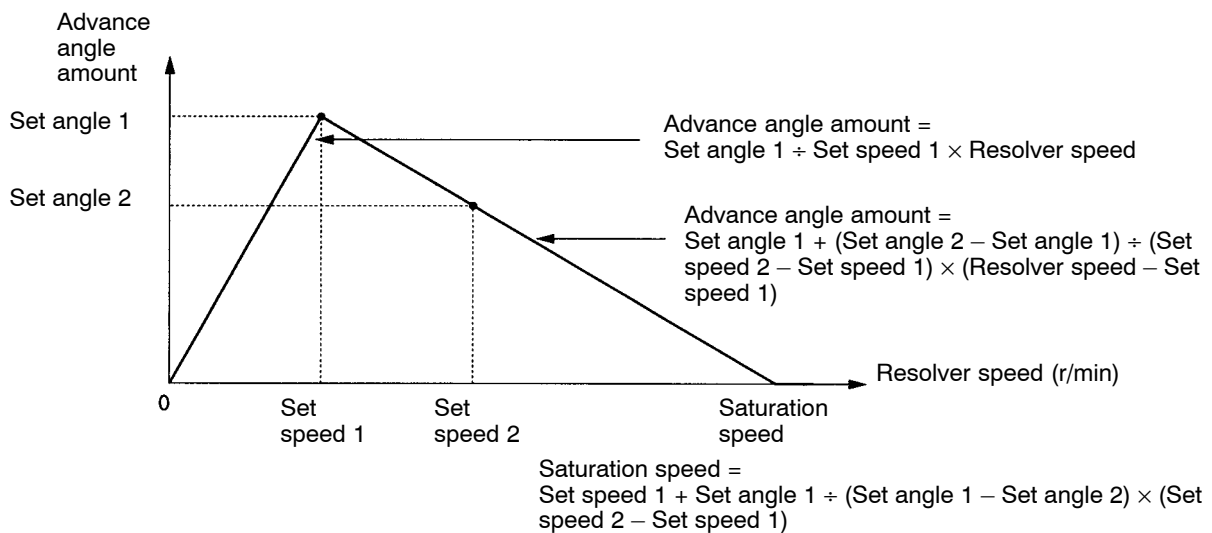

**Note** The lowest compensation value is 0.

**Advance Angle Compensation Function Processing**

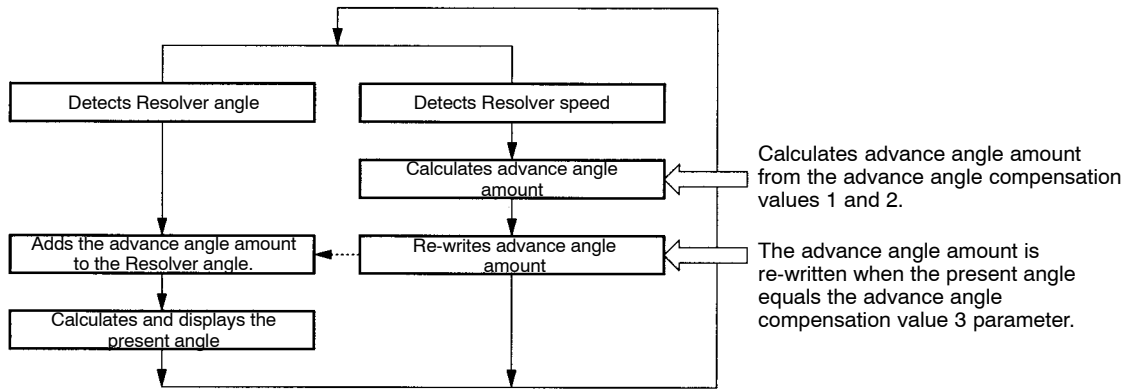

**Note** 1. Resolver angle detection and Resolver speed detection are performed in different cycles.

**Note** 2. The “Resolver angle” is the angle after origin compensation (or origin shift) has been performed for the electrical absolute angle of the Resolver.

- For example, assume that the advance angle compensation value 3 is set to “30” and the result of the advance angle calculation has changed from “0” to “1.” This calculation result is reflected, not immediately but when the present angle reaches “30.” In other words, when the present angle “30” is detected, the present angle is compensated to “31.” When this compensation is performed, therefore, present angle “30” is skipped. (An operation example is shown below.)

Resolver angle	25	26	27	28	29	30	31	32	33	34	35	36
Advance angle amount	0					1						
Present angle	25	26	27	28	29	31	32	33	34	35	36	37

- The processing is the same when the advance angle amount is to be reduced. For example, if the advance angle amount changes from “10” to “5,” the Resolver angle, advance angle amount, and present angles will be as shown below. In this instance, the present angles “25” through “29” are repeated.

Resolver angle	15	16	17	18	19	20	21	22	23	24	25	26
Advance angle amount	10					5						
Present angle	25	26	27	28	29	25	26	27	28	29	30	31

In this way, the present angles do not continue in numerical order from the angle where the present angle and the advance angle compensation value 3 coincide. The following points must be taken into consideration, therefore, when using the advance angle compensation function.

- Set advance angle compensation value 3 in a section where the cam output does not change. (Set in the middle of a section where ON or OFF status continues for a long time.)
- As much as possible, do not operate the machinery while the advance angle amount is changing (accelerating or decelerating.) (Start real operation after the speed has stabilized.)
- If the machinery must be operated during acceleration or deceleration, change the system settings to minimize the change in advance angle amounts as much as possible. (Consider gentle acceleration or deceleration and minimizing the change in advance angle amount or speeding up the peripheral devices (or slowing down the drive axle side) and reducing the size of the compensation amount itself.)

- Make sure that the machinery is operating normally.

■ Related Parameters (SET Mode)

● Advance Angle Compensation Value 1

Function level 2

Function No.	b (b)	Parameter No.	3	Setting range	Speed data : 0 to 1600 (800) (see note 1) Angle data: 0 to 359 (719) (see note 1)
--------------	-------	---------------	---	---------------	--

● Advance Angle Compensation Value 2

Function level 2

Function No.	b (b)	Parameter No.	4	Setting range	Speed data: 0 to 1600 (800) (see note 1) Angle data: 0 to 359 (719) (see note 1)
--------------	-------	---------------	---	---------------	---

- Use these parameters to set the Resolver speed and advance angle amount.
- The Resolver speed (r/min) is set as the speed data and the compensation amount is set as the angle data.
- The factory settings for both speed and angle data is “0.”

**Note 1.** The data for 720 resolution (divisions/revolution) is shown in parentheses.

**Note 2.** When the speed data is set to “0,” the angle data can only be set to “0.”

**Note 3.** The same speed data cannot be set for advance angle compensation values 1 and 2, unless the settings are “0.”

**Note 4.** These parameters are enabled by turning OFF the power supply and turning it ON again.

● Advance Angle Compensation Value 3

Function level 2

Function No.	b (b)	Parameter No.	5	Setting range	0 to 359 (0 to 719) (see note 1)
--------------	-------	---------------	---	---------------	----------------------------------

- Use this parameter to set the point to change the angle based on the advance angle compensation.  
For example, if the advance angle amount changes from “0” to “1,” the angle must increase by “1” somewhere in the rotation. This parameter sets the position for that change. The advance angle amount is updated when the Resolver angle matches advance angle compensation amount 3.
- The factory setting is “0.”

**Note 1.** The data for 720 resolution (divisions/revolution) is shown in parentheses.

**Note 2.** Set advance angle compensation value 3 in a section where the cam output does not change. (Set in the middle of a section where ON or OFF status continues for a long time.) If cam outputs with short ON/OFF durations are set near advance angle compensation value 3, cam outputs may not be made (if the advance angle amount is increasing) or may be output twice (if the advance angle amount is decreasing).

**Note 3.** These parameters are enabled by turning OFF the power supply and turning it ON again.

Operation

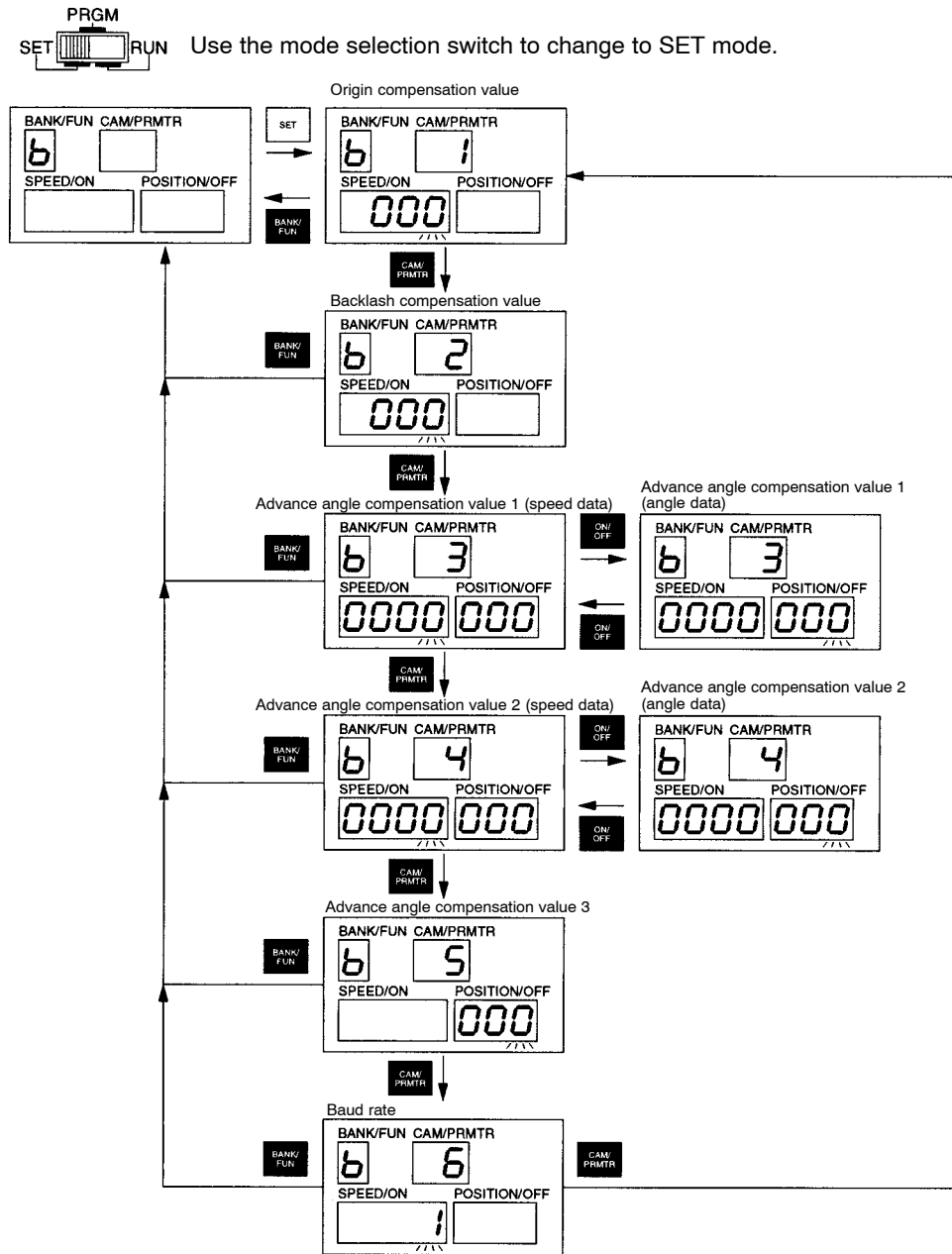

- If the advance angle compensation value (Function No. b, Parameters 3 to 5) is displayed, the present settings will be displayed in the SPEED/ON and POSITION/OFF displays and the first digit (rightmost digit) will be flashing. (The SPEED/ON display will be blank for advance angle compensation value 3.)
- Use the Forward, Up, and Down Keys to change the data. (For advance angle compensation values 1 and 2, use the ON/OFF Switching Key to switch between speed and angle data.)
- Press the Set Key and the data will remain lit for approximately one second, the setting will be confirmed, and the display will resume flashing.
- If the data is inappropriate and the Set Key is pressed, all displays will flash twice and then return to the settings before the data was edited. Re-input the correct data.

- Press the Clear Key to return the data to the factory settings. If the Clear Key is pressed, the three digits of data will start flashing. Press the Set Key while the data is flashing and the display will change to “— — —” and the factory settings will be restored. If the Clear Key is pressed again while the data is flashing, the data will not be initialized and the display will return to the edited status.

● **Advance Angle Compensation Enable/Disable**

Function level 2

<b>Function No.</b>	H (h)	<b>Parameter No.</b>	2	<b>Setting range</b>	0, 1
---------------------	-------	----------------------	---	----------------------	------

- Set to “1” to enable advance angle compensation. (0: Advance angle compensation disabled; 1: Advance angle compensation enabled.)
- The factory setting is “0.”

**Note** This parameter is enabled when the power is turned OFF and then turned ON again.

**Operation**

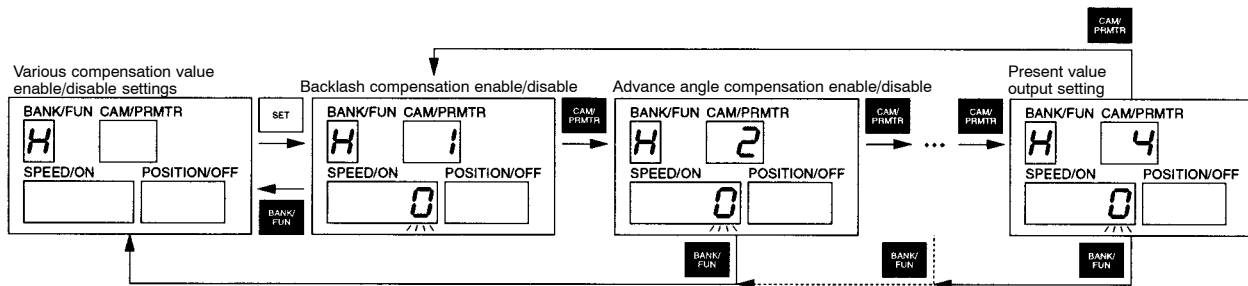

- If the advance angle compensation enable/disable function (Function No. H, Parameter No. 2) is displayed, the present settings will flash in the SPEED/ON display.
- Use the Up and Down Keys to set the data.
- Press the Set Key and the data will stop flashing for approximately one second, the setting will be confirmed, and the display will resume flashing.

**3-6-7 Cam Protect**

■ **Functions**

- The cam protect function protects cams and banks from accidental changes or deletion of cam ON/OFF data.
- Operations are limited in the following ways when data is cam protected.

Protected cam data cannot be changed or deleted.

Banks containing protected cam data cannot be deleted.

The P-CLR operation (clear all cam programs) cannot be performed.

If any of these operations are attempted, an E-22 (cam protect input prohibited) error will be displayed. (The program will not be changed or deleted.)

■ Related Parameters (SET Mode)

● Cam Protect

Function level 2

Function No.	C (C)	Parameter No.	---	Setting range	---
--------------	-------	---------------	-----	---------------	-----

- Use this parameter to set or release cam protection for individual banks and cams.
- The factory setting is “no cam protection for any cam.”

**Note** This parameter is enabled when the power is turned OFF and then turned ON again.

Cam Protect Display

• SPEED/ON

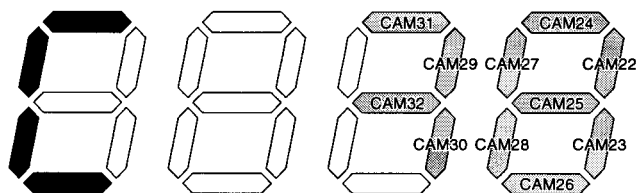

• POSITION/OFF

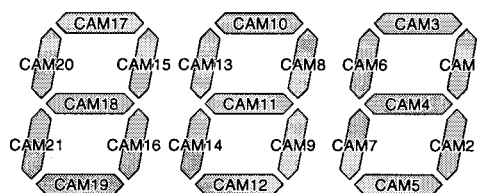

- The cam protect status for a particular cam number is shown by the ON/OFF status of the a 7-segment indicator.

- ON: Cam protected
- OFF: Not cam protected

**Note** The 3F88L-160 (16-point model) Cam Positioner does not have cam numbers 17 to 32. (Those indicators will remain OFF).

**Operation**  
**Outline for Setting and Releasing Cam Protect**

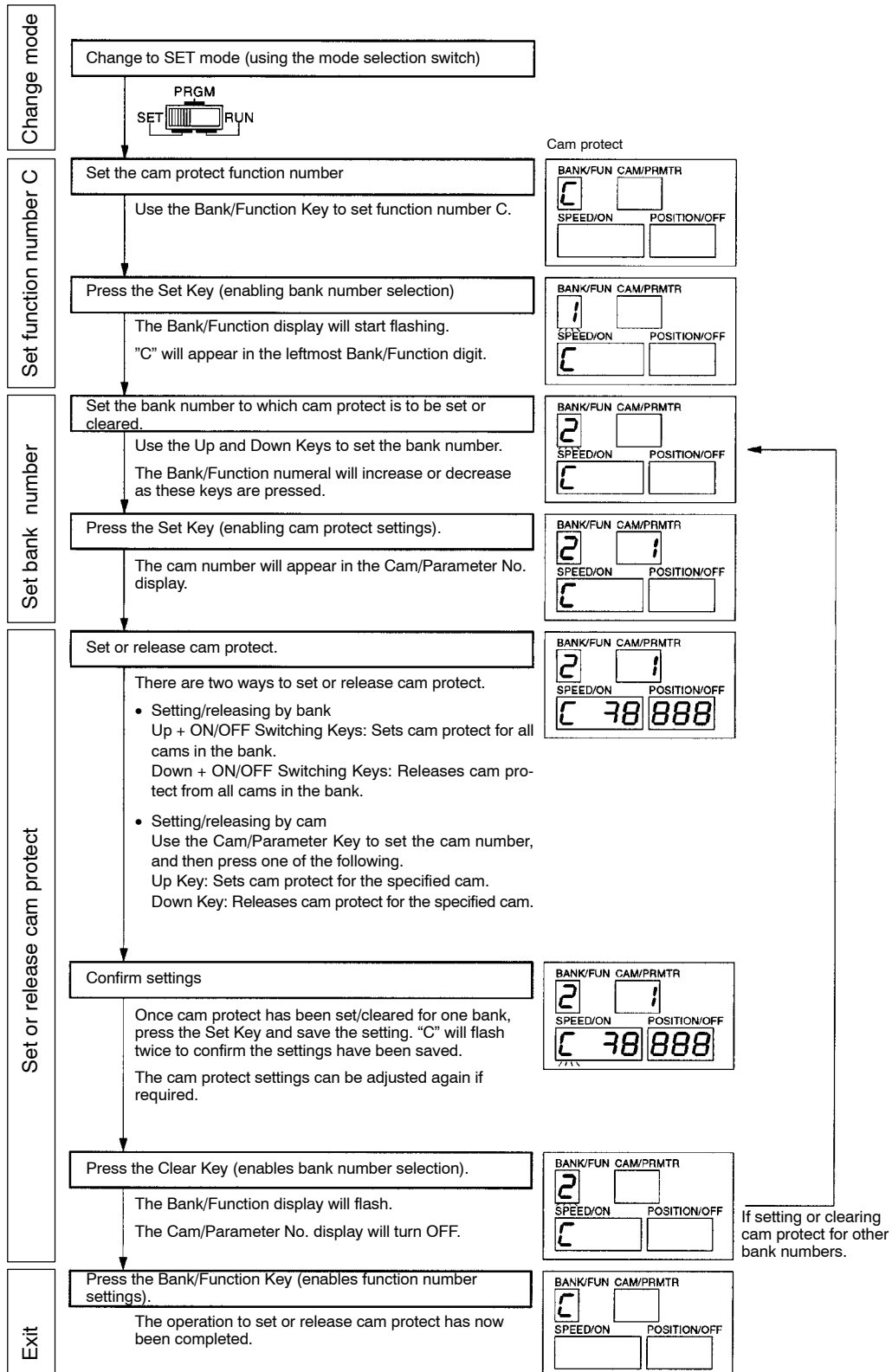

Setting/Releasing Cam Protect Procedure 1 (Enabling Cam Protect Settings)

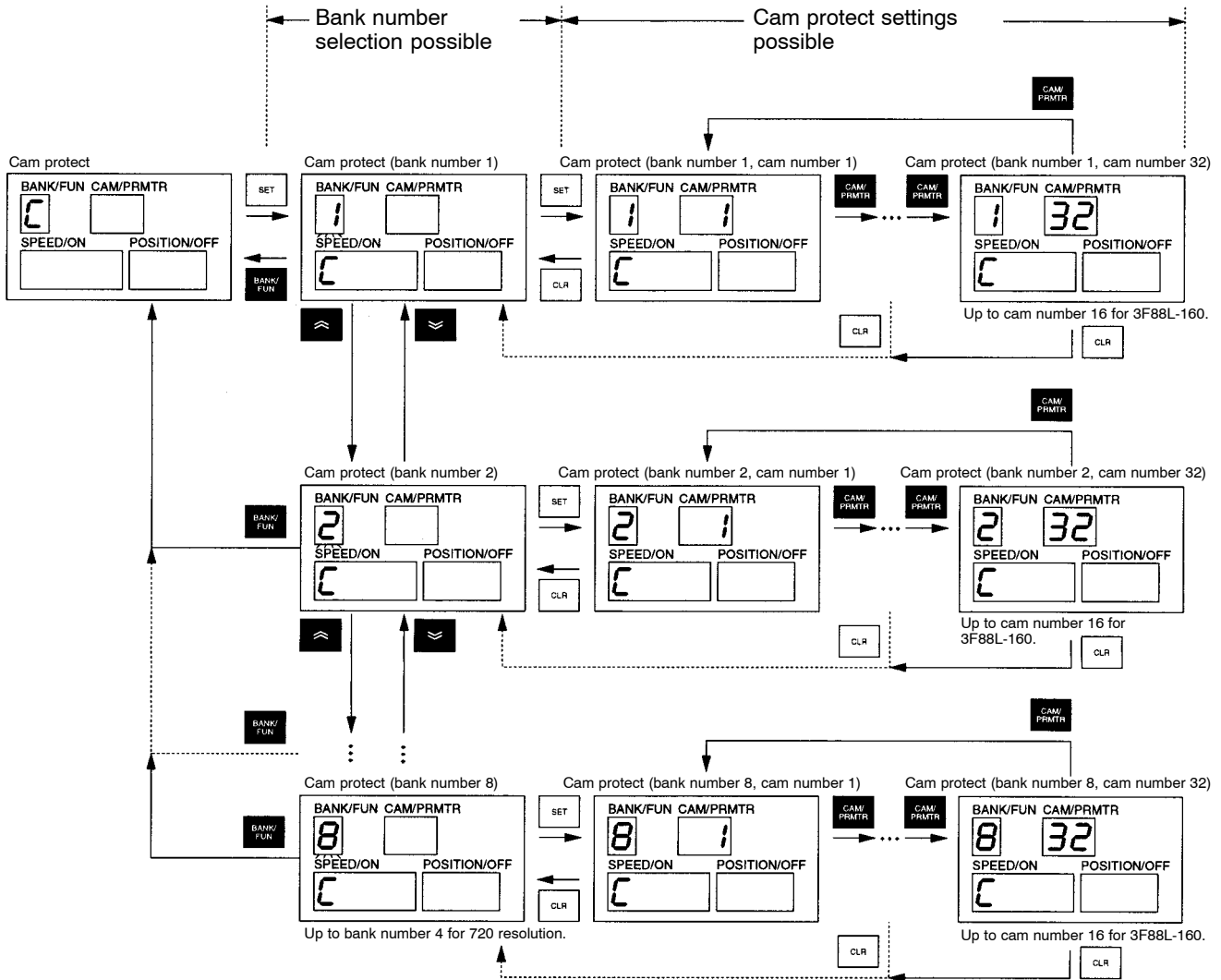
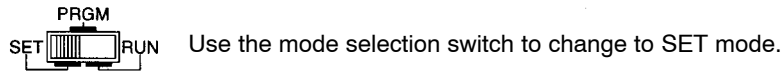

- Use the Bank/Function Key to set cam protect (Function No. C) and press the Set Key, and the bank number will flash in the Bank/Function display (indicating that bank number selection is enabled.)  
 Use the Up and Down Keys to set the bank number containing the cam to be cam protected.
- Next, press the Set Key to display the cam number in the Cam/Parameter No. display. The current cam protect status will be displayed in the SPEED/ON and POSITION/OFF displays (and cam protect settings can be made).



Setting/Releasing Cam Protect Procedure 2 (Setting/Releasing Cam Protect within a Set Bank)

• Setting/Releasing Cam Protect by Bank

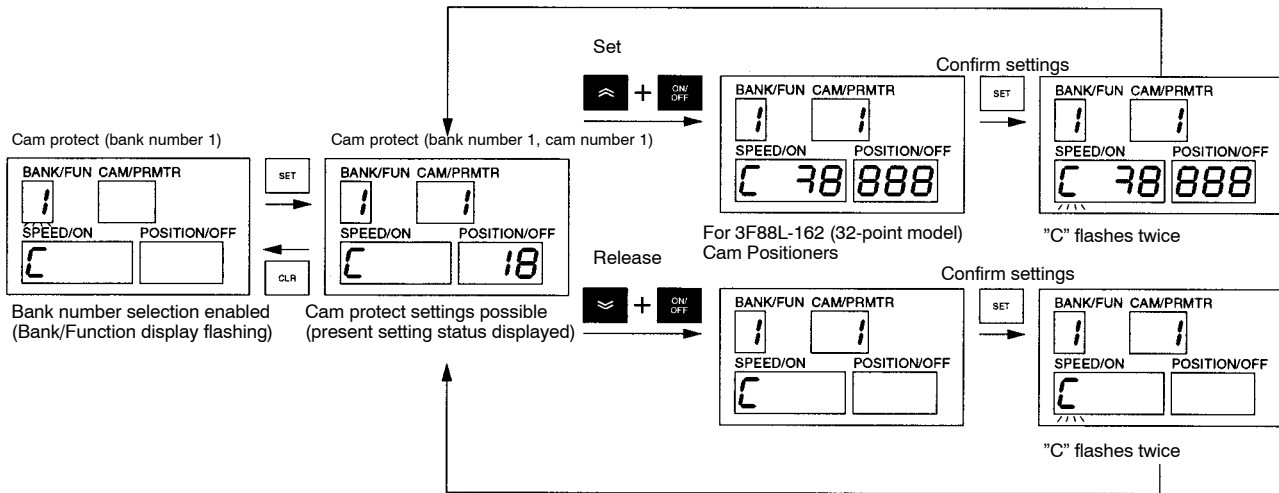

- While the bank and cam numbers are displayed (cam protect settings enabled), press the ON/OFF Switching Key while pressing the Up Key to set cam protect for all cams within that bank number.
- While the bank and cam numbers are displayed (cam protect settings enabled), press the ON/OFF Switching Key while pressing the Down Key to release cam protect for all cams within that bank number.
- Once cam protect has been set or released, press the Set Key to confirm the cam protect settings. "C" will flash twice on the display. (Perform this operation for each bank. The setting will be canceled if the Set Key is not pressed before moving to another bank.)
- Once the settings have been completed, press the Clear Key to return to bank selection enabled status (Bank/Function display flashing).
- To set or release cam protect for another bank number (the above operation), use the Up and Down Keys when in bank selection enabled status (Bank/Function display flashing) to select the new bank number, and repeat the above operation.
- Press the Bank/Function Key when in bank selection enabled status (Bank/Function display flashing) to return to function number setting status ("C" displayed in the Bank/Function display).

• Setting/Releasing Cam Protect by Cam

Bank selection enabled status  
(Bank/Function display flashing)

Cam protect settings enabled status  
(current setting status displayed)

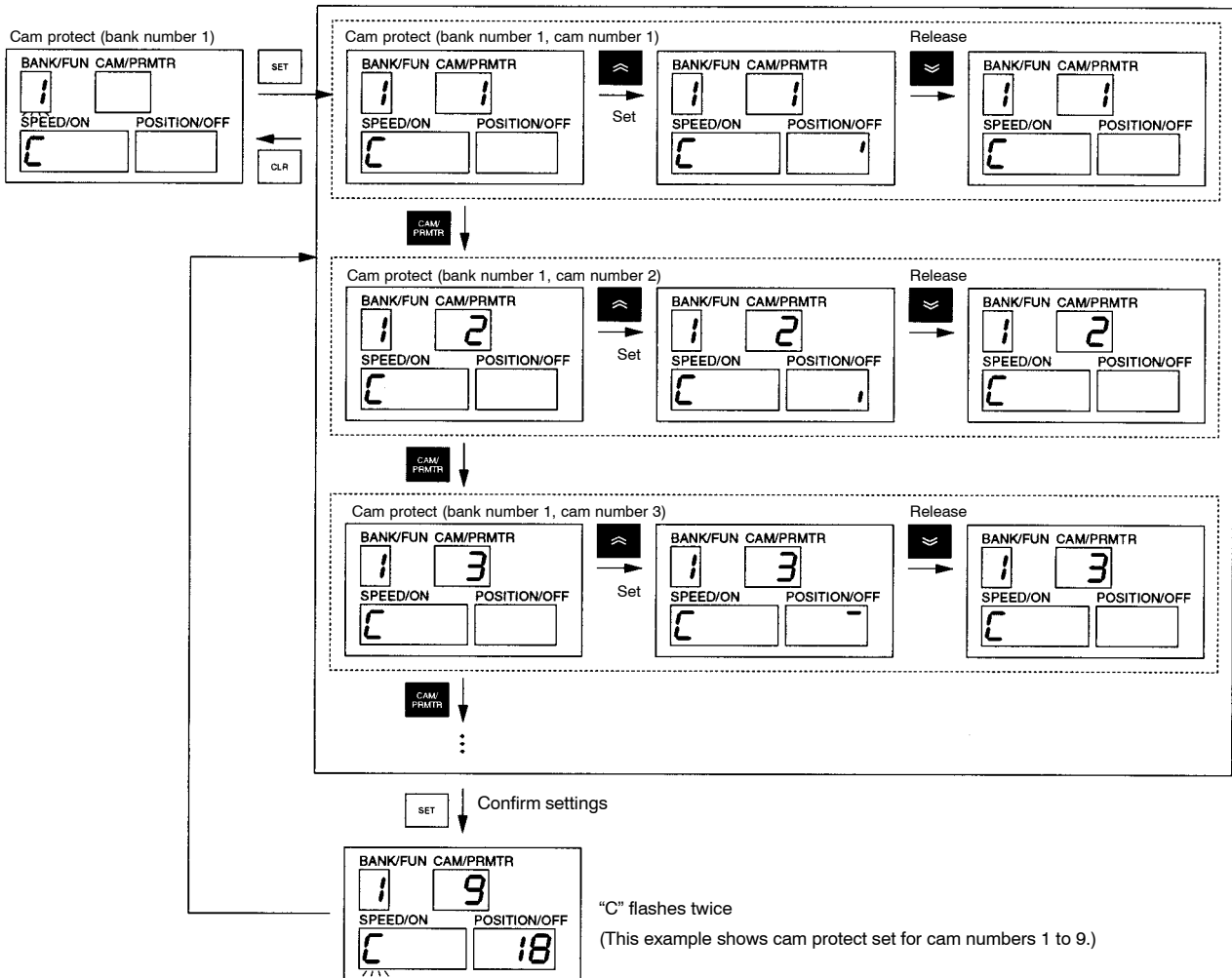

- While the bank and cam numbers are being displayed (cam protect settings enabled status), press the Cam/Parameter Key and set the cam number for which cam protect is to be set or released.
- Press the Up Key to set cam protect for that bank and cam number. (The relevant indicators will turn ON.) Press the Down Key to release cam protect for that bank and cam number. (The relevant indicators will turn OFF.)
- To set or release cam protect for another cam number, press the Cam/Parameter Key, change the cam number, and repeat the above operation.
- Once cam protect has been set or released, press the Set Key to confirm the setting. “C” will flash twice. (Perform this operation for each bank. The setting will be canceled if the Set Key is not pressed before moving to another bank.)
- Once the settings have been completed, press the Clear Key to return to bank selection enabled status (Bank/Function display flashing).
- To set or release cam protect for another bank number (the above operation), use the Up and Down Keys when in bank selection enabled status (Bank/Function display flashing) to select the new bank number, and repeat the above operation.

- Press the Bank/Function Key when in bank selection enabled status (Bank/Function display flashing) to return to function number setting status ("C" displayed in the Bank/Function display).

### 3-6-8 One-direction Function

#### ■ Functions

- Enables cam outputs when the Resolver is rotating in one direction only, either forward or reverse. (If the Resolver rotates in the opposite direction, the output status will be held.)
- This function can be set for any cam.

**Note 1.** The one-direction function is disabled when compensation operation, trial operation, or teaching is being executed.

**Note 2.** When backlash compensation is enabled, the one-direction function works at the angle after backlash compensation has been executed. (For example, even if the Resolver rotates in the opposite direction, the system will not consider this as the reverse direction until the backlash compensation amount has been exceeded.)

**Note 3.** When advance angle compensation is enabled, cam outputs are made at the angle after advance angle compensation has been made. Rotation direction for the one-direction function is determined by the increasing or decreasing angles after backlash compensation has been performed (the angle after advance angle compensation is not used to determine the rotation direction). Therefore, even when the present angle is decreasing (when decelerating or due to a reduction in the advance angle amount), this is not considered as reverse direction. (Refer to 3-6-6 Advance Angle Compensation.)

#### ■ Related Parameters (SET Mode)

##### ● One-direction Function Setting

Function level 2

<b>Function No.</b>	F (f)	<b>Parameter No.</b>	---	<b>Setting range</b>	0 to 2
---------------------	-------	----------------------	-----	----------------------	--------

- Use this parameter to set or clear the one-direction function for each cam.
- The settings are as follows:
  - 0: One-direction function disabled (factory setting)
  - 1: Enabled in the forward direction (cam output status held when rotating in reverse)
  - 2: Enabled in the reverse direction (cam output status held when rotating forward)

**Note 1.** This parameter is enabled when the power is turned OFF and then ON again.

**Note 2.** Use the CW/CCW setting switch to set either CW or CCW as the forward direction. Refer to 3-5-2 Initial Settings for details.

Operation

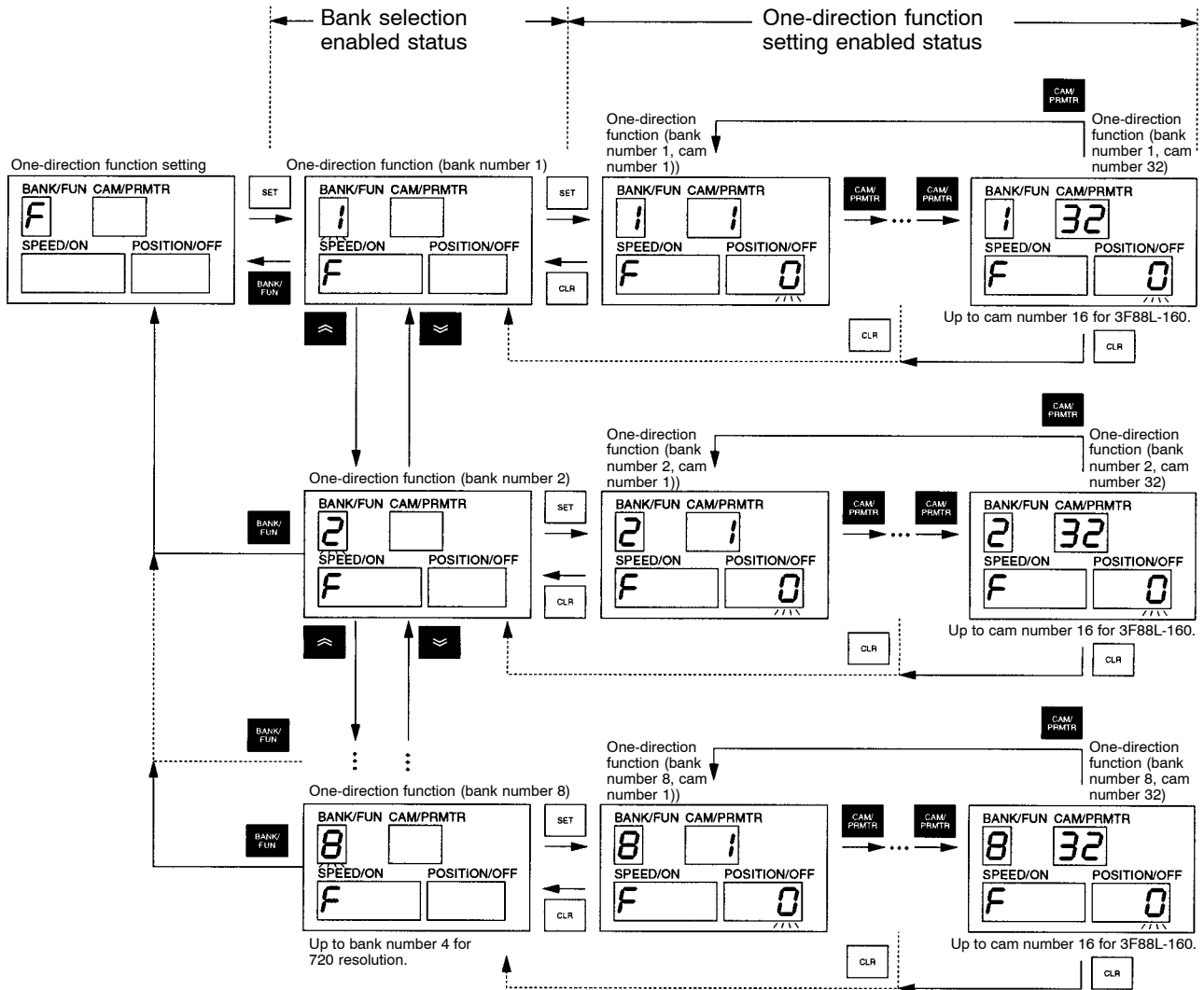
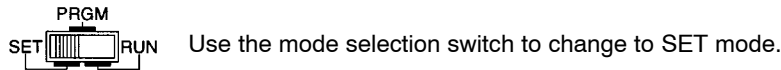

- Use the Bank/Function Key to set the one-direction function (Function No. F) and press the Set Key to make the bank number flash in the Bank/Function display (bank selection enabled status). Use the Up and Down Keys to set the bank number that contains the cam for which one-direction function is to be set.
- Next, press the Set Key to display the cam number in the Cam/Parameter No. display. The present settings will flash in the POSITION/OFF display (one-direction function setting enabled status).
- While the bank and cam numbers are displayed (one-direction function setting enabled status), press the Cam/Parameter Key to change the cam number. Set the cam number for which the one-direction function is to be set.
- Use the Up and Down Keys to set the data.
- Press the Set Key. The data will remain lit for approximately one second, the data will be confirmed, and the display will start flashing again.

■ Operation Example

- Cam Program: Cam outputs ON between 100 and 200 (360 resolution)
- One-direction Setting: Enabled in the forward direction (cam output status held for rotation in the opposite direction)

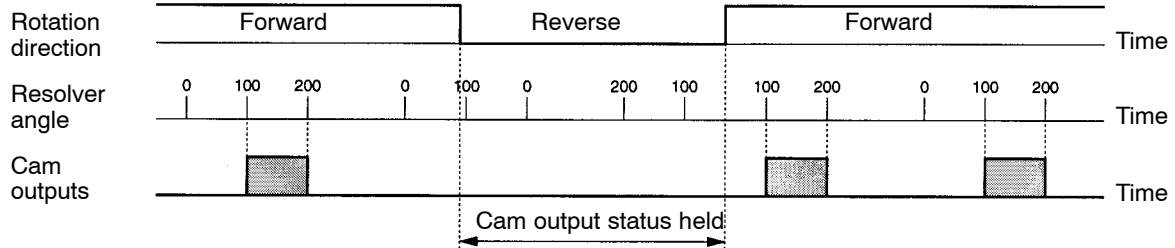

**Note** If both the one-direction function and the advance angle compensation function are set at the same time, cam outputs may be left out or output twice when the advance angle data is compensated. (Refer to 3-6-6 Advance Angle Compensation.)

3-6-9 Output Hold Function

■ Functions

- The output hold function holds the cam output status when an error has been generated or when switching from RUN mode to SET or PRGM mode.
- When the output hold function is enabled, the cam output status is held even in the following circumstances.
  - When banks are switched during operation.
  - When in PRGM or SET mode only when START signal is ON.
  - During origin shift processing.
  - When an error has been generated (except E-10 or watchdog errors).
- Even when the output hold function is enabled, cam outputs are OFF in the following circumstances.
  - When the START signal is OFF.
  - When the RESET signal is being input.
  - When a E-10 or watchdog error has been generated.

■ Related Parameters

● Output Hold

Function level 2

Function No.	H (h)	Parameter No.	3	Setting range	0, 1
--------------	-------	---------------	---	---------------	------

- Settings: 0: Output hold disabled (factory setting), 1: Output hold enabled

**Note** This parameter is enabled when the power is turned OFF and then ON again.

Operation



Use the mode selection switch to change to SET mode.

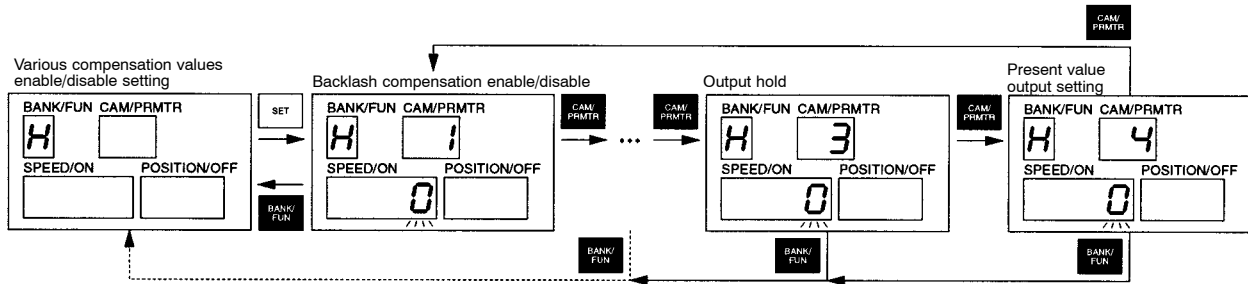

- When output hold (Function No. H, Parameter No. 3) is displayed, the present settings will flash in the SPEED/ON display.
- Use the Up and Down Keys to set the data.
- Press the Set Key. The data will remain lit for approximately one second, the settings will be confirmed, and then the data will resume flashing again.

### 3-6-10 Present Value Output Function

#### ■ Function

The present value output uses the cam output signal and output signals that are sent to the M7E or M7F Display Units.

#### ■ Related Parameter (SET Mode)

##### ● Present Value Output Setting

Function level 2

<b>Function No.</b>	H (h)	<b>Parameter No.</b>	4	<b>Setting range</b>	0 to 4
---------------------	-------	----------------------	---	----------------------	--------

- Use this parameter to set the present value output function.
- The settings are as follows:
  - 0: No present value output function (factory setting)
  - 1: 4-digit present angle output (no units)
  - 2: 4-digit speed output (no units)
  - 3: 3-digit automatically switching present angle/speed output (with units)
  - 4: 4-digit automatically switching present angle/speed output (with units)

For automatically switching data output, the present angle data will be output when the speed is less than 4 r/min and the speed data will be output when the speed is 4 r/min or greater.
- Use settings 1 to 4 for M7E Display Units and 1 or 2 for M7F Display Units.
- The present value output signals are the same as cam output signals. When this function is used, therefore, some cam outputs can no longer be used. (Different cam outputs are used for 3F88L-160 and 3F88L-162 Cam Positioners.)

**Note 1.** This parameter is enabled when the power is turned OFF and then ON again.

**Note 2.** Use setting 2 or 4 when displaying speeds of 1,000 r/min or greater.

Setting	Display data	Cams used for 3FF88L-160	Cams used for 3FF88L-162
1	4-digit present angle output (no units)	CAM 13 to 16: Display data CAM 12: 1st digit LE signal CAM11: 2nd digit LE signal CAM10: 3rd digit LE signal CAM 9: 4th digit LE signal	CAM 29 to 32: Display data CAM 28: 1st digit LE signal CAM 27: 2nd digit LE signal CAM 26: 3rd digit LE signal CAM 25: 4th digit LE signal
2	4-digit speed output (no units)	CAM 13 to 16: Display data CAM 12: 1st digit LE signal CAM11: 2nd digit LE signal CAM10: 3rd digit LE signal CAM 9: 4th digit LE signal	CAM 29 to 32: Display data CAM 28: 1st digit LE signal CAM 27: 2nd digit LE signal CAM 26: 3rd digit LE signal CAM 25: 4th digit LE signal
3	3-digit automatically switching present angle/speed output (with units)	CAM 13 to 16: Display data CAM 12: 1st digit LE signal CAM11: 2nd digit LE signal CAM10: 3rd digit LE signal CAM 9: "Degrees" units output CAM 8: "r/min" units output	CAM 29 to 32: Display data CAM 28: 1st digit LE signal CAM 27: 2nd digit LE signal CAM 26: 3rd digit LE signal CAM 25: "Degrees" units output CAM 24: "r/min" units output
4	4-digit automatically switching present angle/speed output (with units)	CAM 13 to 16: Display data CAM 12: 1st digit LE signal CAM11: 2nd digit LE signal CAM10: 3rd digit LE signal CAM 9: 4th digit LE signal CAM 8: "Degrees" units output CAM 7: "r/min" units output	CAM 29 to 32: Display data CAM 28: 1st digit LE signal CAM 27: 2nd digit LE signal CAM 26: 3rd digit LE signal CAM 25: 4th digit LE signal CAM 24: "Degrees" units output CAM 23: "r/min" units output

Operation



Use the mode selection switch to change to SET mode.

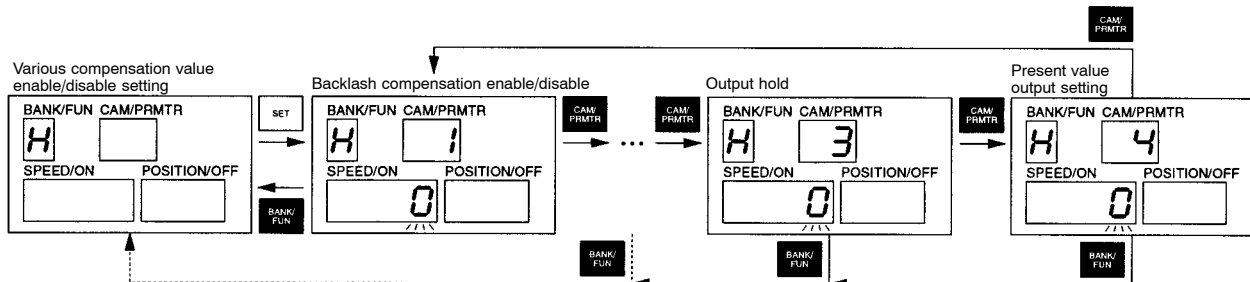

- Display the present value output setting (Function No. H, Parameter No. 4) and the present settings will flash in the SPEED/ON display.
- Use the Up and Down Keys to set the data.

- Press the Set Key. The data will remain lit for approximately one second, the settings will be confirmed, and then the data will resume flashing again.

■ Data Output Timing

• 3F88L-160 (16-point Model)

• For Present Value Outputs Set to “2” (4-digit Resolver Speed (No Units))

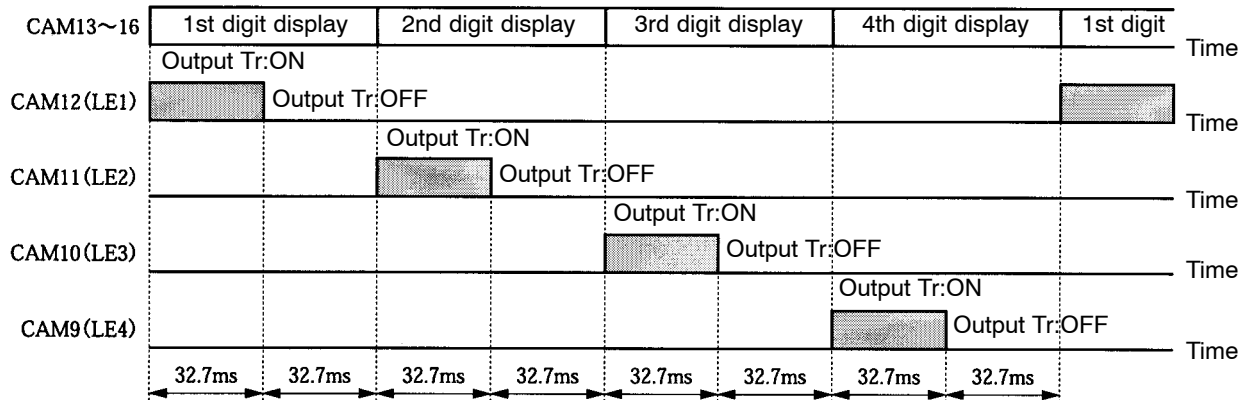

**Note** The output timing for each digit of display data (CAM 13 to 16) and each digit’s LE signal (CAM9 to 12) are shown below.

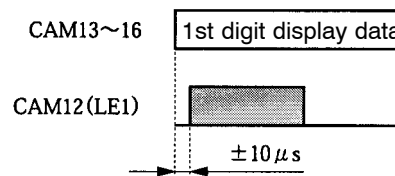

3-6-11 Pulse Output Function

■ Function

- The pulse output function creates cam programs that turn ON and OFF at even intervals at particular bank and cam numbers.
- The cam programs that turn ON/OFF at even intervals can be set from any angle (pulse start position).

**Note 1.** For pulse settings to be made, the resolution/(pulse number × 2) must be an integer. If this equation does not produce an integer, the pulse number will be changed to the nearest pulse number that will give an integer. The pulse numbers are as follows:

For 360 resolution: 1, 2, 3, 4, 5, 6, 9, 10, 12, 15, 18, 20, 30, 36, 45, 60, 90, 180

For 720 resolution: 1, 2, 3, 4, 5, 6, 8, 9, 10, 12, 15, 18, 20, 24, 30, 36, 40, 45, 60, 72, 90, 120, 180, 360

If a pulse that falls between any of these pulse numbers is set, it will be converted to the next largest pulse number. For example, if “7” is set for 720 resolution, it will be converted to “8.”

**Note 2.** If the pulse number and pulse start position are set, a cam program that turns ON at the pulse start position will be created.



- Note 3.** Cam programs created using the pulse output function, like other cam programs, can be edited and deleted in PRGM mode and edited freely using compensation and trial operations.
- Note 4.** The pulse output function creates cam programs and does not store the parameters set here in memory.
- Note 5.** Refer to 3-5-3 *Cam Program Creating and Checking* for information on how to check cam programs that have been created using this function.
- Note 6.** If the pulse output function is used to create a new cam program for a cam number that already has a cam program input, the existing cam program does not have to be cleared beforehand. When pulse output settings are made, all existing cam programs are cleared and overwritten by the pulse output cam program.

■ **Operation Example**

- For Pulse Number = 4, Pulse Start Position = 30°

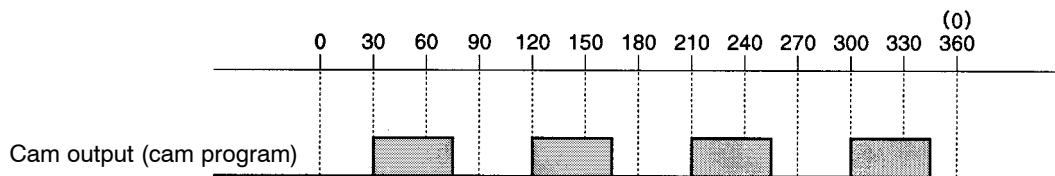

■ **Related Parameters (SET Mode)**

● **Pulse Output Setting**

Function level 2

Function No.	P (p)	Parameter No.	---	Setting range	---
--------------	-------	---------------	-----	---------------	-----

- Use this parameter to create pulse output programs.

Operation

PRGM  
SET RUN Use the mode selection switch to change to SET mode.

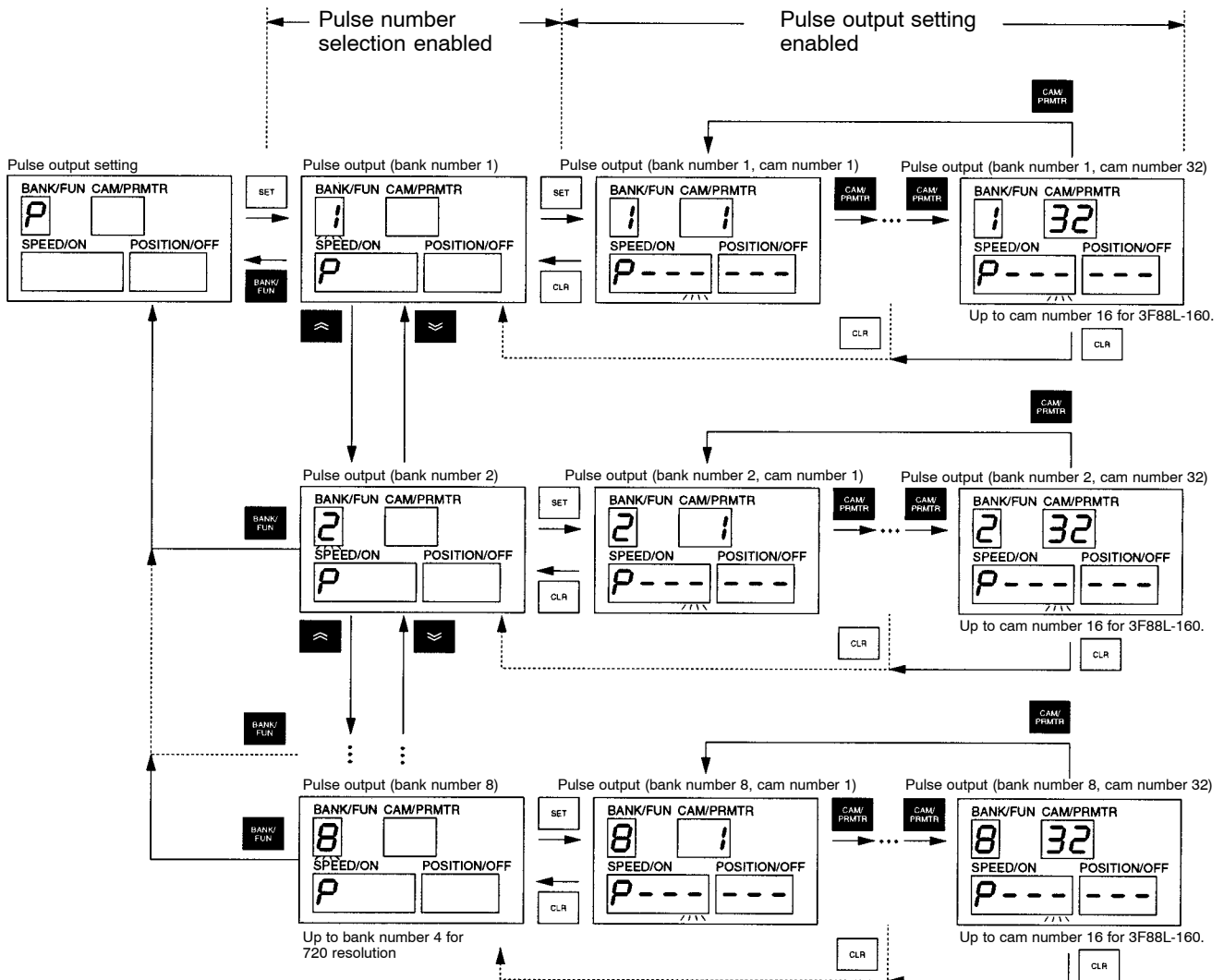

- Use the Bank/Function Key to make the pulse output settings (Function No. P) and press the Set Key and the bank number will flash in the Bank/Function display. Use the Up and Down Keys to set the bank number that contains the cam for which a pulse output program is to be created.
- Next, press the Set Key to display the cam number in the Cam/Parameter No. display. Alternatively, “P— —” (first digit flashing) will appear in the SPEED/ON display and “— — —” will appear in the POSITION/OFF display.
- Press the Cam/Parameter Key until the cam number to be set appears.
- The data that appears in the SPEED/ON display is the pulse number. Set a pulse number between 1 and 180 for 360 resolution or between 1 and 360 for 720 resolution.
- The data that appears in the POSITION/OFF display is the pulse start position. Set a pulse start position between 0 and 359 (for 360 resolution) and 0 and 719 (for 720 resolution).
- Use the Forward, Up, and Down Keys to set the data. Use the ON/OFF Switching Key to switch between pulse number and pulse start position data.

- Press the Set Key. The data will remain lit for approximately one second, the settings will be confirmed, and then the data will resume flashing again.
- If the data is inappropriate and the Set Key is pressed, all displays will flash twice and then return to the settings before the data was edited. Re-input the correct data.

### 3-6-12 Teaching

#### ■ Function

- The teaching function is used to input data from the Resolver as ON/OFF angle settings while the machinery is being manually operated.
- The only editing of cam programs allowed while using this function is the registration or deletion of ON/OFF angle data.

**Note 1.** If the teaching function is used on cam numbers for which a cam program has already been input, steps will be added to that cam program.

**Note 2.** The ON or OFF angles for cam programs that have been already input cannot be changed separately.

**Note 3.** The teaching function cannot be used if the Resolver speed is 4 r/min or greater.

#### ■ Related Parameter (SET Mode)

##### ● Teaching

Function level 2

Function No.	d (d)	Parameter No.	---	Setting range	---

- Use this parameter to create cam programs.

Operation

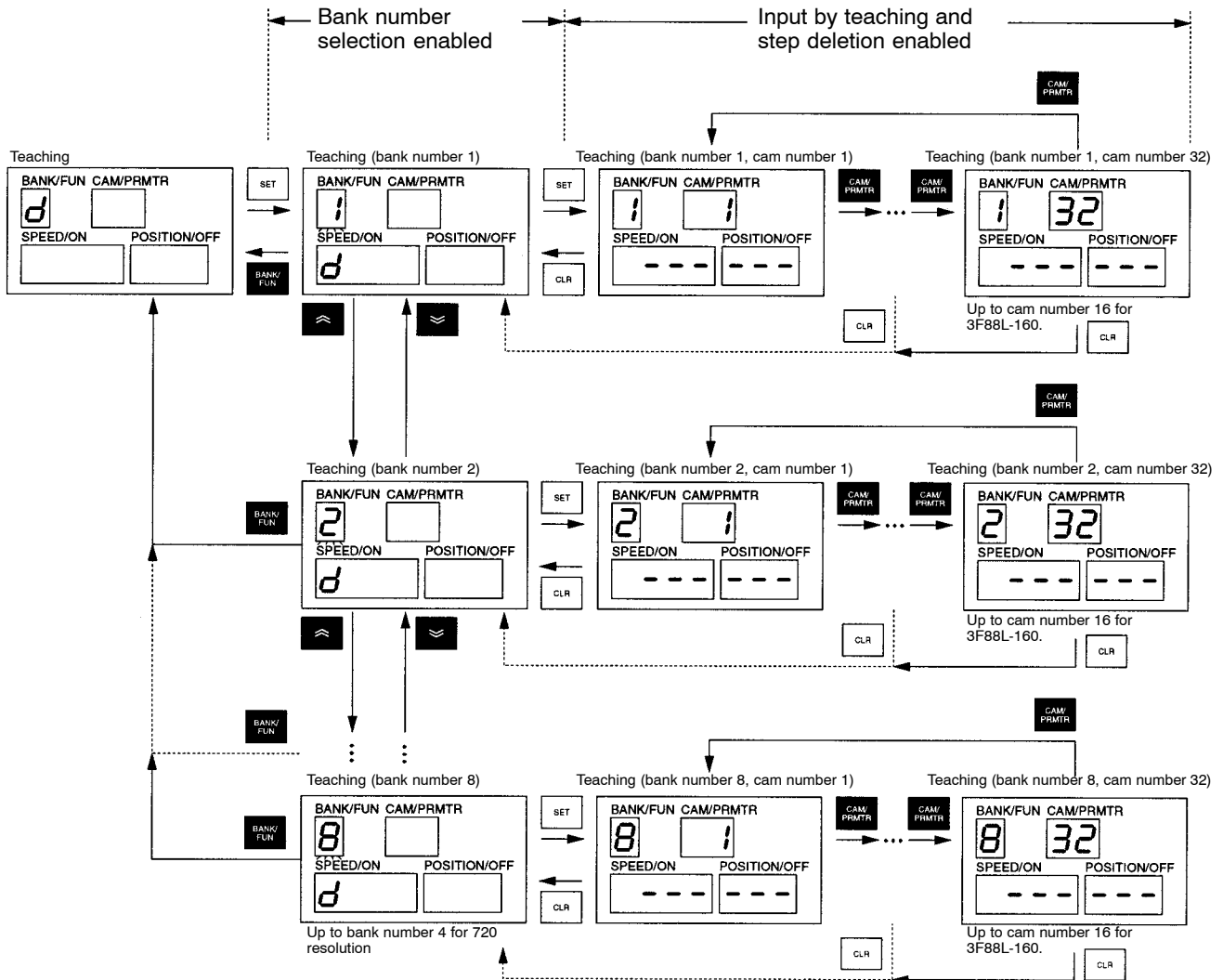

- Use the Bank/Function Key to set teaching (Function No. d) and press the Set Key to display the bank number in the Bank/Function display (flashing). Use the Up and Down Keys to set the bank number that contains the cam to which the teaching function will be applied.
- Next, press the Set Key to display the cam number in the Cam/Parameter No. display.

**If there is no cam program for that cam number**

The SPEED/ON display will be “— — —” and the POSITION/OFF display will be “— — —.”

**If there is a cam program for that cam number**

The ON and OFF angles for step 1 will be displayed.

Press the Set Key to display the ON and OFF angles for step 2.

Press the Set Key while the last step is displayed. The displays will be “— — —” and “— — —.”

- Press the Cam/Parameter Key until the cam number to be set is displayed.

• Input Using the Teaching Function

Operation	Display	Explanation
		Change the status to display the cam number to which the teaching function is to be applied.
+		Press the Set Key while pressing the ON/OFF Switching Key. The ON angle can now be input. The present angle will be flashing in the SPEED/ON display.
(Manual operation of machinery)		Using manual operation, move the machine to the ON angle position.
		Press the Set Key to set the ON angle and change the status to enable OFF angle input. <b>Note</b> Press the Clear Key to re-set the ON angle. The system will return to the ON angle input status.
(Manual operation of machinery)		Using manual operation, move the machine to the OFF angle position.
		Press the Set Key to set the OFF angle. The ON and OFF angles for the step created using the teaching function will be displayed in the SPEED/ON and POSITION/OFF displays.
+		To apply the teaching function to the next step in the same cam number, press the Set Key while pressing the ON/OFF Switching Key again. Repeat the same operation as described above.

**Note** If the ON or OFF setting overlaps with the ON region for the next step when the Set Key is pressed to save those settings, an E23 (cam program duplication error) will be generated. Press the Clear Key if this error occurs. The error will be cleared and the status will return to the angle settings that generated the error.

If an E23 (cam program duplication error) occurs, check the contents of the already input cam program. Refer to *Deleting Cam Program Steps* on the next page for information on how to delete the relevant step.

● Changes in Display after Teaching Inputs

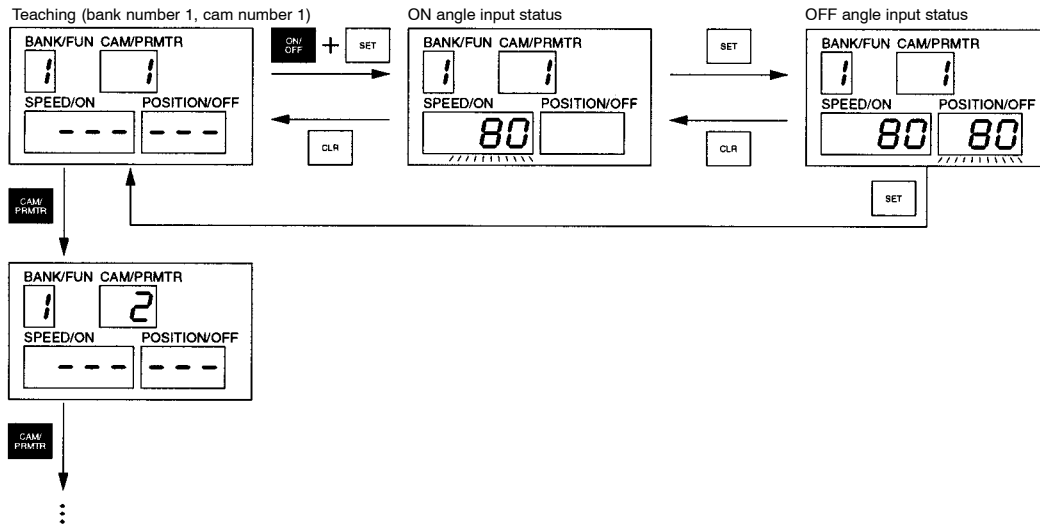

● Deleting Cam Program Steps

- Perform the following operation to delete steps in an existing cam program for a particular cam number.

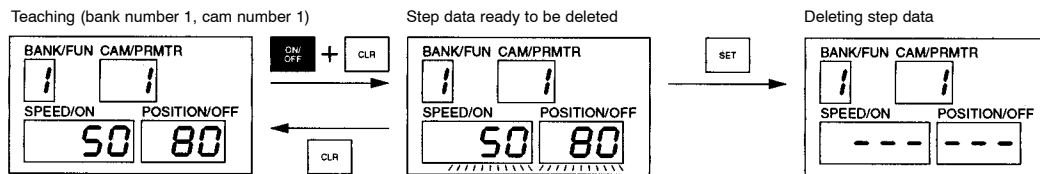

- Display the step to be deleted. (Press the Set Key to display the steps in order.)
- Press the Clear Key while pressing the ON/OFF Switching Key. The ON and OFF angles will flash (indicating that the step data is ready to be deleted.)
- Press the Set Key to delete the data. The displays will change to “---” and “---.”
- If the Clear Key is pressed when the step data is ready to be deleted, the delete operation will be canceled, and the display will return to the original display.

**Note** The “---” and “---” displayed after the step has been deleted indicate the next status after the last step. Therefore, press the Set Key while pressing the ON/OFF Switching Key to display the ON and OFF angles for step 1.

**Relationship between Teaching and Various Compensation Functions**

- If the teaching function is used while other compensation functions are set, the present angle as adjusted by the compensation function will be read as ON angle or OFF angle data.
- When using compensation functions, perform teaching after these functions have been changed to the “enabled” status.

- Origin compensation (origin shift): Refer to 3-6-4 *Origin Compensation and Origin Shift.*
- Backlash compensation: Refer to 3-6-5 *Backlash Compensation.*
- Advance angle compensation: Refer to 3-6-6 *Advance Angle Compensation.*

One-direction function setting: Not related to the teaching function.

These settings will become enabled after the power has been turned OFF and then ON again. Therefore, always turn OFF the power once before starting the teaching operation.

**Teaching and Backlash Compensation**

Backlash compensation operates when the Resolver rotates in the reverse direction. In other words, the present angle does not change until the Resolver rotating in the reverse direction has turned the amount for the backlash compensation. When using the teaching function, therefore, the machine must be manually operated to rotate the Resolver axis. For example, when the Resolver is connected to the drive axle that is driven by a motor and if there is backlash between the drive axle and the driven side (load side), teaching must be performed by moving the drive axle. If the driven side is moved for teaching, the backlash compensation will work in the opposite direction and teaching will not be performed correctly.

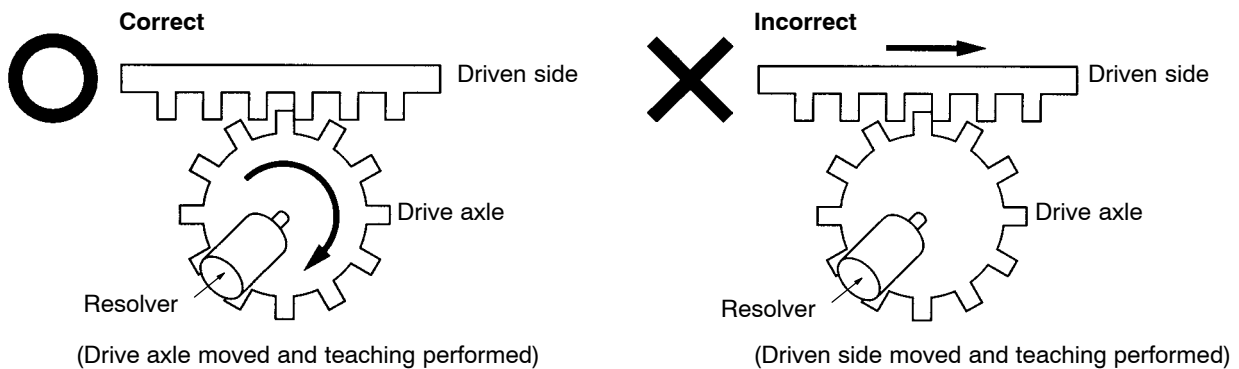

For example, in the right-hand example, even if the driven side is moved to the right for the amount of the backlash compensation, the Resolver will not rotate, and therefore, the present angle will not change. Even if the driven side is moved to the left for the amount of the backlash compensation, the backlash compensation function will work and the present angle will not change.

**Teaching and Advance Angle Compensation**

Advance angle compensation is performed when the Resolver is rotating. Teaching, in principle, is performed while the Resolver is stationary. Advance angle compensation, therefore, generally does not affect the teaching function. However, advance angle compensation does affect the teaching function for teaching that can be executed only when the Resolver is rotating (at less than 4 r/min). In particular, if a large advance angle compensation is set at low speed, the present angle may not be continuous in the region where the advance angle is compensated, and the angle to which the teaching function has been applied will become inappropriate.

When using the advance angle function, therefore, pay attention to the following points when using the teaching function also.

- Perform teaching while the Resolver is not rotating.
- When the Resolver cannot be stopped, keep the advance angle amount as small as possible for rotation at low speed (less than 4 r/min).
- When the Resolver cannot be stopped, perform teaching when there is no acceleration (when the speed is constant.)

Furthermore, when teaching has been completed, change the advance angle compensation position (advance angle compensation value 3) to a section where the cam output does not change (the middle of a section where the ON or OFF status continues for a long time.)

### 3-6-13 Copy Function (Data Transfer)

#### ■ Function

- The copy function receives and transmits data (cam programs and parameters) between two Cam Positioners.
- By setting one Cam Positioner as the Master and one as the Slave, data can be read, written, and verified.
- Cam Positioners are connected via communications ports by RS-232C cables.

#### ■ Connecting RS-232C Cables

##### ● Connecting Cam Positioners

RS-232C cables are connected via the Cam Positioner communications ports.

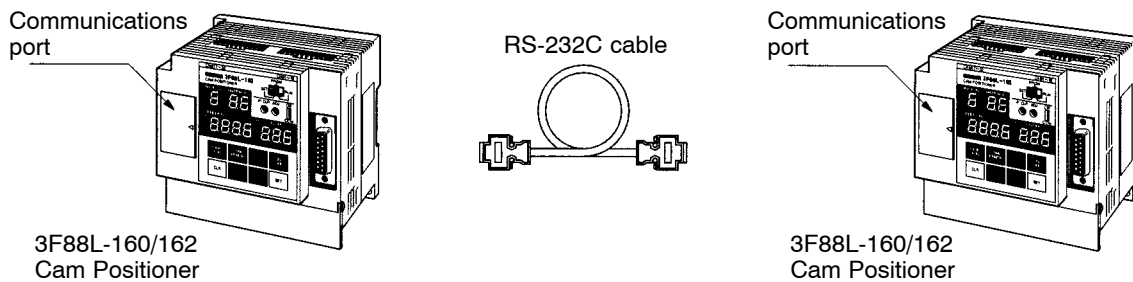

##### ● Communications Port Pin Arrangement

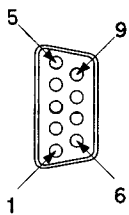

Pin No.	Symbol	Signal name
1	NC	---
2	RD	Receive data
3	SD	Send data
4	NC	---
5	SG	Signal ground

Pin No.	Symbol	Signal name
6	NC	---
7	RS	Send request
8	CS	Send enabled
9	NC	---
Shell	FG	Frame ground

##### ● RS-232C Cable Assembly

An RS-232C cross cable is used for communications between Cam Positioners (9-pin D-sub, socket – socket type)

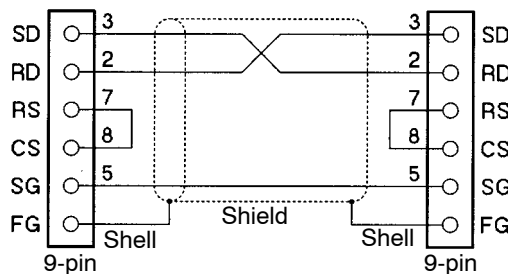



**Recommended Products**

Name	Model (manufacturer)		No. of Units	Description
RS-232C Connector	XM3D-0921 (OMRON) or the equivalent		2	9-pin D-sub connector (socket)
	XM2S-0913 (OMRON) or the equivalent		2	Connector hood
Cable	Non-UL product	AWG28×5P IFVV-SB (Fujikura Ltd.)	1	Shielded multi-conductor cable
		CO-MA-VV-SB 5P×28AWG (Hitachi Cable, Ltd.)		
	UL product	UL2464 AWG28×5P IFS-RVV-SB (Fujikura Ltd.)		
		UL2464-SB (MA) 5P×28AWG (Hitachi Cable, Ltd.)		

**Note** Keep the RS-232C cable under 5 m.

**■ Outline of Data Transfer Operation**

The basic operation when transferring data (cam programs and parameters) between two Cam Positioner Units is outlined below.

1. Connect the RS-232C Cable.

Connect the cable according to the instructions under *Connecting RS-232C Cables* in the previous section.

2. Set the baud rate.

Set the baud rate (Function No. b, Parameter No. 6). Set the same baud rate for both Master and Slave Units.

1: 9,600 bps (factory setting)

2: 19,200 bps

3. Turn OFF the power supply and turn it ON again.

If the baud rate setting has been changed, turn OFF the power supply and turn it ON again. This will enable the baud rate setting.

4. Put the Slave Unit into transmission enabled mode.

Display Function No. t, Parameter No. 0 on the Slave Cam Positioner Unit.

5. Put the Master Unit into transmission enabled mode.

Display Function No. t, Parameter No. 1 on the Master Cam Positioner Unit. Set the data as required for the transmission and press the Set Key. The data transfer will begin.

1: Data read (Reads programs and parameters from the Slave to the Master.)

2: Data write (Writes programs and parameters from the Master to the Slave.)

3: Data verification (Verifies the Master programs and parameters against the Slave programs and parameters.)

■ Related Parameters (SET Mode)

● Baud Rate Setting

Function level 2

Function No.	b (b)	Parameter No.	6	Setting range	1, 2
--------------	-------	---------------	---	---------------	------

- The Baud rate setting function sets the baud rate for data transmission.
- The baud rate settings are explained below.
  - 1: 9,600 bps (factory setting)
  - 2: 19,200 bps
- Set the same baud rate for both the Master and Slave Units.

**Note** This parameter is enabled after the power has been turned OFF and then ON again.

Operation

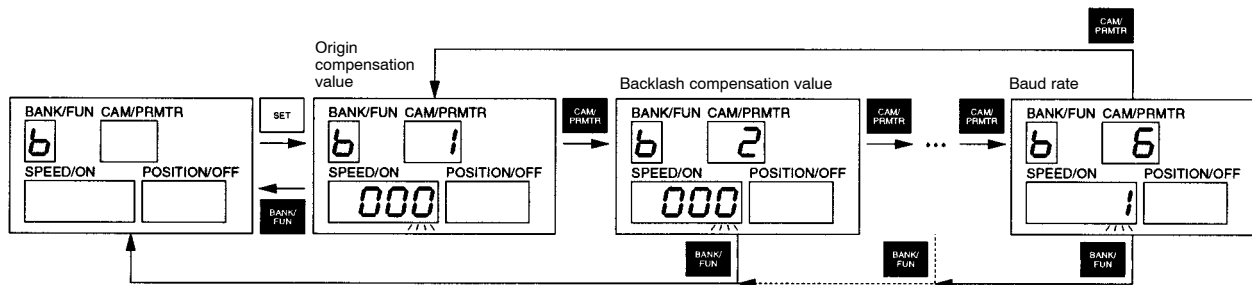
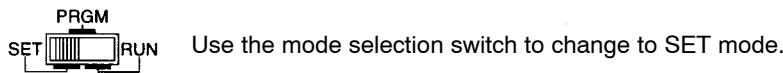

- When the baud rate (Function No. b, Parameter No. 6) is displayed, the present baud rate settings flash in the SPEED/ON display.
- Use the Up and Down Keys to change the data.
- Press the Set Key and the data will remain lit for approximately one second, the setting will be confirmed, and the display will resume flashing.
- If the baud rate setting has been changed, turn OFF the power supply and turn it ON again.

● Data Transfer (Slave Unit Settings)

Function level 1 2

Function No.	t (t)	Parameter No.	0	Setting range	---
--------------	-------	---------------	---	---------------	-----

- Use this parameter to make the settings on the Slave Unit to enable data transfer.

● Data Transfer (Master Unit Settings)

Function level 1 2

Function No.	t (t)	Parameter No.	1	Setting range	0 to 3
--------------	-------	---------------	---	---------------	--------

- Use this parameter to make the settings on the Master Unit to enable data transfer.
- The settings are shown below.
  - 0: Disabled (factory setting)
  - 1: Data read (Reads cam programs and parameters from the Slave to the Master Unit.)
  - 2: Data write (Writes cam programs and parameters from the Master to the Slave Unit.)
  - 3: Data verification (Verifies the Master programs and parameters against the Slave programs and parameters.)

Operation

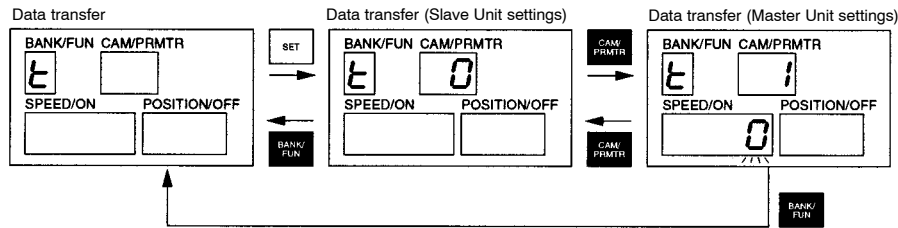

• **Slave Cam Positioner Settings**

- Use the Bank/Function Key to set data transfer (Function No. t) and press the Set Key. “0” (Slave Unit settings) will appear in the Cam/Parameter No. display.
- The settings for the Slave Unit have now been completed. While this data is displayed, make the settings for the Master Cam Positioner Unit.

• **Master Cam Positioner Settings**

- Use the Bank/Function Key to set data transfer (Function No. t) and press the Set Key. “0” (Slave Unit settings) will appear in the Cam/Parameter No. display.
- Press the Cam/Parameter Key to display “1” (Master Unit settings)
- “0” will flash in the SPEED/ON display.
- Use the Up and Down Keys to set the data.
  - 0: Disabled (factory setting)
  - 1: Data read (Reads cam programs and parameters from the Slave to the Master Unit.)
  - 2: Data write (Writes cam programs and parameters from the Master to the Slave Unit.)
  - 3: Data verification (Verifies the Master programs and parameters against the Slave programs and parameters.)
- If the incorrect setting is made, e.g., if data read (setting “1”) and data write (setting “2”) settings are mistaken, important data may be deleted. Check again that the correct setting has been selected.
- Press the Set Key to start communications with the Slave Cam Positioner Unit. During the transfer, the data being transferred (P: parameter; b1 to b8: bank numbers 1 to 8) will be appear in the POSITION/OFF display. The communications will take approximately 40 seconds to be completed.

**Note 1.** The data being transferred will be displayed on the Master Unit only.

**Note 2.** The display will not include “b5” to “b8” for 720 resolution.

- When the communications have been completed normally, press the Set Key to return to the previous display.
- If a communications error has occurred, the error code will appear in the SPEED/ON display. Check the error and press the Clear Key. The error will be cleared. Press the Set Key to return to the previous display.

**Additional Information on the Copy Function**

• **Data Transferred**

All cam programs and parameters will be transferred from one Cam Positioner Unit to the other. The contents of Function No. t (data transfer) and Function No. P (pulse output setting) will not be transferred.

- **Data Transfer between Different Cam Positioner Models**

When data is transferred between 3F88L-160 and 3F88L-162 Cam Positioner Units, cam programs for cam numbers 17 to 32 will be transferred. However, if these programs have been transferred to 3F88L-160 Cam Positioner Units, they cannot be displayed or checked. If data is transferred to a 3F88L-162 Cam Positioner from a 3F88L-160 Cam Positioner that has cam programs for cam numbers 17 to 32, these cam programs can be checked on the 3F88L-162 Cam Positioner side.

- **Operation after Data Transfer**

Once the data transfer has been completed, turn OFF the power for the Cam Positioner that received the data transfer and then turn it ON again. The parameters will be enabled when the power is turned ON again.

The power must be turned OFF and then ON again to determine if the data has been correctly transferred.

- **Communications Errors**

The following communications errors may occur.

**E-22 (Cam Protect Error)**

This cam protect error will occur on the receiving side if there is a cam that has been cam protected in that Cam Positioner. The parameters will be transferred but the cam program will terminate with an error. Clear all cam protects on the receiving Cam Positioner and then re-transfer the data. (Refer to *3-6-7 Cam Protect*.)

If the Cam Positioner transmitting the data is a Master Unit, an E-31 (communications error) will be generated in the Master Unit.

**E-31 (Communications Error)**

This communications error is generated in the Master Unit when there has been no response from the Slave Unit or when there has been a communications data error in the Slave Unit. If this error occurs while data is transferred, transfer of some parameters or partial cam programs may result.

Press the Clear Key to delete the error.

This error will not occur in the Slave Unit.

**E-33 (Verification Error)**

This verification error is generated when the cam programs or parameters on the Master Unit do not match those on the Slave Unit.

Press the Clear Key to delete the error.

This error will not occur in the Slave Unit.

## 3-6-14 Trial/Adjustment Operation

---

---

The trial/adjustment operation function is used to adjust ON and OFF angles while checking the cam output status. This function is made up of the trial operation function and the adjustment operation function. The differences between these two functions is outlined below.

**Trial operation function:** This function is operated in PRGM mode. Regardless of the status of the START input, control and cam outputs are made and the Up and Down Keys are used to change the ON and OFF angles of any cam number in any bank number. (The angles can be changed in units of “1.”)

**Adjustment operation function:** This function is executed in RUN mode when the START input is ON. If the current bank number is being operated, the ON and OFF angles of any cam number within that bank number can be changed by using the Up and Down Keys. (The angles can be changed in units of “1.”)

Normally, the trial operation function is used to check the contents of cam programs when the system is started up and the adjustment operation is used to change angles after the system has started operation. The data changes made using the trial operation and adjustment operation functions are reflected in the outputs at the point the data is changed using the Up and Down Keys.

\*To use the trial/adjustment operation, the function level selection must be set to function level 2 (all functions), in the same way as for other application functions.

---











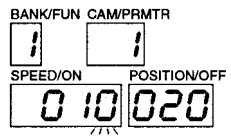

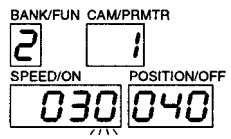

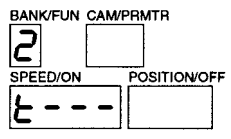

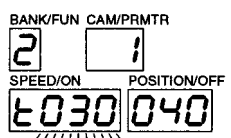
---

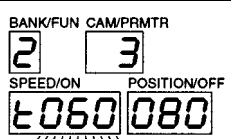
### ■ Trial Operation (PRGM Mode)

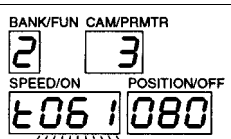
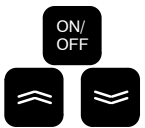
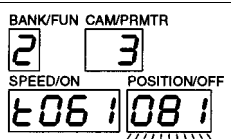
#### ● Outline of Operation

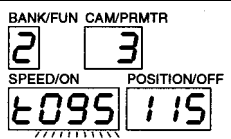
1. Use the mode selection switch to change to PRGM mode.
2. Use the Bank/Function Key to set the bank number containing the cam that is to be adjusted.
3. Press the Set Key while pressing the ON/OFF Switching Key to enable the trial operation function.
4. Use the Cam/Parameter Key to set the cam number to be adjusted.
5. Adjust the ON angle (using the Up and Down Keys)
6. Adjust the OFF angle (by pressing the ON/OFF Switching Key and then using the Up and Down Keys)
7. Press the Set Key to display the next step.
8. The message “Do you want to adjust the next step?” will appear.  
Select “Y” to return to 5 above. Select “N” to continue.
9. The message “Do you want to adjust another cam number?” will appear.  
Select “Y” to return to 4 above. Select “N” to continue.
10. Press the Clear Key to exit the trial operation function.
11. The message “Do you want to adjust another bank number?” will appear.  
Select “Y” to return to 2 above. Select “N” to exit the procedure.

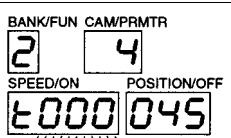
● Procedure

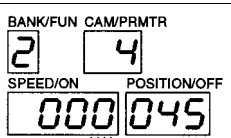







Operation	Display	Explanation
		Use the mode selection switch to change to PRGM mode.
		Use the Bank/Function Key to display the bank number for the trial operation.
		Press the Set Key while pressing the ON/OFF Switching Key The trial operation function is now enabled. <b>Note 1.</b> Press the Clear Key at this stage to return to the previous status. <b>Note 2.</b> From this point, cam outputs corresponding to the Resolver angle will be output.
		Press the Cam/Parameter Key. The cam number will appear in the Cam/Parameter No. display. The ON angle for step 1 will appear (flashing) in the SPEED/ON display. The OFF angle for step 1 will appear (lit) in the POSITION/OFF display.
		Press the Cam/Parameter Key to set the cam number for which angle data is to be adjusted. The ON and OFF angles for step 1 will be displayed (ON angle flashing, OFF angle lit)
		Press the Up and Down Keys to increase or decrease the ON angle. The ON angle for cam outputs will be changed at the same time. <b>Note</b> The Up and Down Keys will not work if the ON section overlaps another step.
		Press the ON/OFF Switching Key to make the OFF angle flash. Use the Up and Down Keys to increase and decrease the OFF angle. (The cam output OFF angles will be changed at the same time.) <b>Note</b> The Up and Down Keys will not work if the ON section overlaps another step.
		Press the Set Key to display step 2. Repeat the same procedure to adjust the ON and OFF angles for step 2 onwards. <b>Note 1.</b> The display will not move on to step 2 if there is only one step. <b>Note 2.</b> During trial operation, the data changes will be reflected in the outputs and cam program at the point the changes are made.
		Press the Cam/Parameter Key to adjust other cam numbers. Step 1 of the next cam number will be displayed. Repeat the same procedure to adjust the angles for each step.
		Press the Clear Key to exit the trial operation function. <b>Note</b> To adjust the cams in another bank number, exit the trial operation, press the Bank/Function Key to set the next bank number to be adjusted, and re-enter trial operation mode.

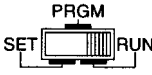
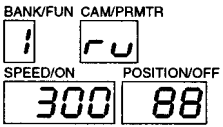
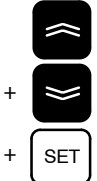
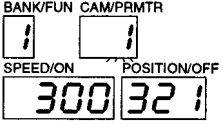





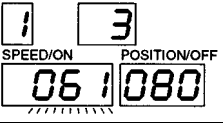

■ Adjustment Operation (RUN Mode)

● Outline of Operation

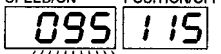
1. Change to RUN mode.
2. Press the Set Key while press the Up and Down Keys to enable the adjustment operation function.
3. Use the Up and Down Keys to set the cam number to be adjusted.
4. Press the Set Key.
5. Adjust the ON angle using the Up and Down Keys.
6. Adjust the OFF angle by pressing the ON/OFF Switching Key and then using the Up and Down Keys).
7. Press the Set Key to display the next step.
8. The message “Do you want to adjust the next step?” will appear.  
Select “Y” to return to 5 above. Select “N” to continue.
9. Press the Cam/Parameter Key.
10. The message “Do you want to adjust another cam number?” will appear.  
Select “Y” to return to 3 above. Select “N” to continue.
11. Press any key other than the Up, Down, or Set Keys to exit the procedure.

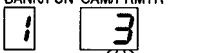
● Procedure

Operation	Display	Explanation
		(Display during normal RUN mode.)
		Press the Set Key while pressing the Up or Down Keys. The adjustment operation function will now be enabled. The cam number will be displayed (flashing) in the Cam/Parameter No. display. <b>Note</b> Press any key other than the Up, Down, or Set Keys at this point to return to the previous status.
		Use the Up and Down Keys to set the cam number for which angle data is to be adjusted.
		Press the Set Key. The angles for step 1 will be displayed (ON angle flashing and OFF angle lit).
		Press the Up and Down Keys to increase or decrease the ON angle. The cam output ON angle will change at the same time. <b>Note</b> The Up and Down Keys will not work if the ON section overlaps another step.
		Press the ON/OFF Switching Key to make the OFF angle flash. Use the Up and Down Keys to increase and decrease the OFF angle. (The cam output OFF angles will be changed at the same time.) <b>Note</b> The Up and Down Keys will not work if the ON section overlaps another step.

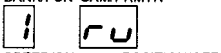
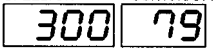
Operation	Display	Explanation
	<p>BANK/FUN CAM/PRMTR                        SPEED/ON POSITION/OFF  </p>	<p>Press the Set Key to save the adjusted angle data and display step 2.                      Use the same procedure to adjust the ON and OFF angles for step 2 onwards.  <b>Note 1.</b> The display will not move on to step 2 if there is only one step.  <b>Note 2.</b> During adjustment operation, the data changes will be reflected in the outputs and cam program at the point the changes are made.</p>
	<p>BANK/FUN CAM/PRMTR                        SPEED/ON POSITION/OFF  </p>	<p>Press the Cam/Parameter Key to adjust other cam numbers.                      The display will return to a flashing cam number.                      Repeat the same operation to adjust the angles for each step in other cam numbers.                      Use the Up and Down Keys to set the cam number, use the Set Key to display the ON and OFF angle data, use the Up and Down Keys to adjust the ON angle data, use the ON/OFF Switching Key to make the OFF angle flash, use the Up and Down Keys to adjust the OFF angle, and use the Set Key to save the adjusted data. Repeat this operation as required.)</p>
   Other Keys	<p>BANK/FUN CAM/PRMTR                        SPEED/ON POSITION/OFF  </p>	<p>To exit the adjustment operation function, press any key other than the Up, Down, or Set Keys while the cam number is flashing.                      The display will exit the adjustment operation function and return to normal RUN mode.</p>



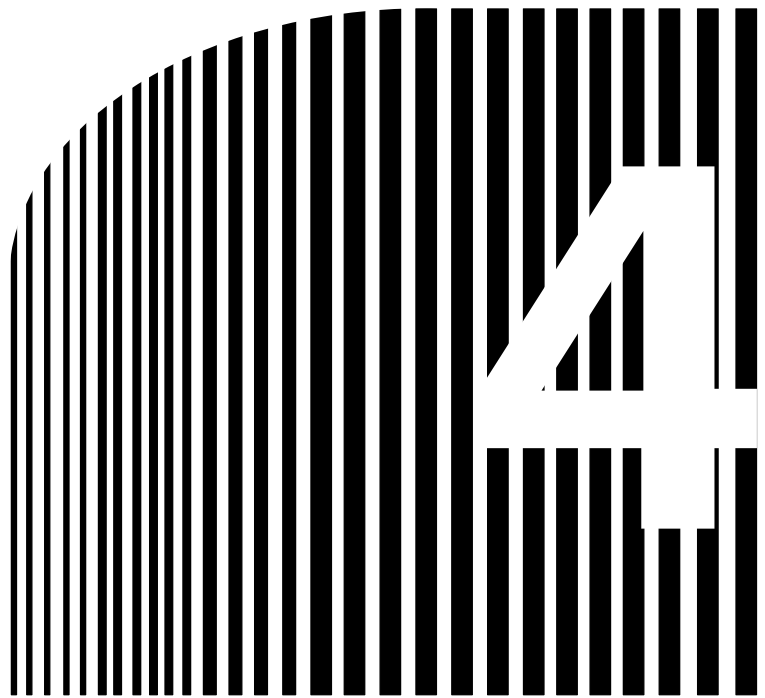

## Chapter 4

### • Communications •

- 4-1 Overview of CompoWay/F Communications
- 4-2 Command and Response Frames
- 4-3 Command Types
- 4-4 Executing CompoWay/F Commands with Protocol Macros

## 4-1 Overview of CompoWay/F Communications

The 3F88L-160/162 Cam Positioner has a communications port that conforms to CompoWay/F Type B. Through communications, the 3F88L-160/162 is capable of reading and writing cam programs and parameters as well as monitoring the present cam angle and Resolver speed.

**Note** CompoWay/F is OMRON's standard protocol for serial communications. It provides a standard frame format and commands based on the Factory Interface Network Service (FINS) used by OMRON Programmable Controllers in order to facilitate communications between components or between a personal computer and a component.

**Note** FINS is a protocol used for message communications between controllers on OMRON FA networks.

### ■ Cam Positioner Communications

In communications between a Cam Positioner and a host CPU, communications capabilities differ depending on the operating mode of the Cam Positioner.

Mode	Function	Data	Communications capabilities	Command name
RUN PRGM SET	Read	Error code	Reads error code.	Controller Status Read
		Executing status	Reads Cam Positioner status.	
		Model and communications buffer size	Reads model and communications buffer size (send or receive buffer size, whichever smaller).	Unit Attribute Read
		Internode Echo test	Conducts an internode echo test.	Internode Echo Test
		Model and version	Reads model and version.	Controller Data Read
RUN	Monitor	Resolver speed	Reads Resolver speed.	Memory Area Read
		Present cam angle	Reads present cam angle.	
		Cam output status	Reads cam output status.	
		Executing bank	Reads the bank being executed.	
		Control I/O status	Reads control I/O status.	
	Operating State Change	---	Changes the current operating state to the one in which parameters and programs can be sent and received in RUN mode. Returns from the above state to the original state.	Operation Com- mand

Mode	Function	Data	Communications capabilities	Command name
SET (Slave Unit setting)	Read/Write	Resolution/compensation settings	Reads and writes operation parameters.	Parameter Area Read/Write
		Compensation values	Reads and writes compensation value parameters.	
		Cam data protect settings	Reads and writes cam data protect settings.	
		Output hold information	Reads and writes output hold information.	
		Cam program	Reads and writes cam programs.	
	Program Clear	---	Clears cam programs.	
	Parameter Clear	---	Returns parameters to their default settings.	
Parameter Update	---	Enables parameters that will be made valid when the power is turned OFF and then ON. (Using this command makes it unnecessary to turn the power OFF and then ON when making parameter settings valid.)		

■ Connecting to Host CPU

Connect the Cam Positioner to the host CPU through the communications port.

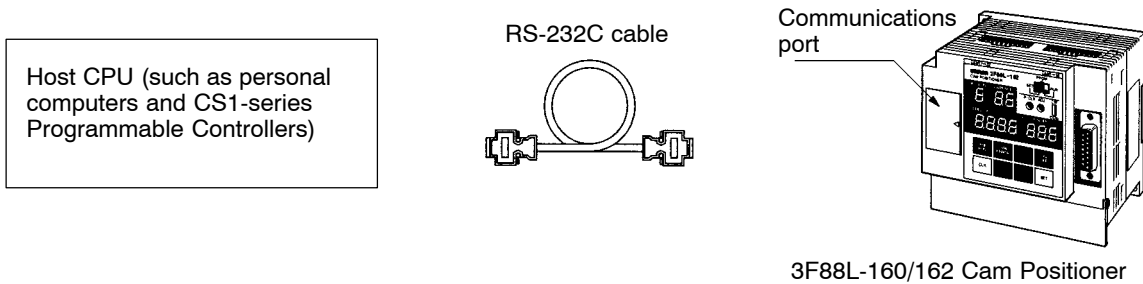

■ Communications Specifications

The communications specifications of the Cam Positioner are shown below. Set the communications conditions of the host CPU to these specifications.

- Communications method: RS-232C
- Synchronization method: Start-stop synchronization
- Baud rate: 9,600 or 19,200 bps (parameter setting)
- Transmission code: ASCII
- Data bit length: 7 bits
- Stop bit: 2 bits
- Parity: Even
- Node number: "00"
- Subaddress: "00"

**Note 1.** The Cam Positioner is factory-set to a baud rate of 9,600 bps. To use 19,200 bps, relevant parameters must be set. Refer to 3-6-13 Copy Function (Data Transfer) for details.

**Note 2.** Node numbers and subaddresses are the codes used when executing commands. In this chapter, numeric values enclosed in double quotation marks such as “00” represent ASCII codes. Numeric values followed by Hex such as (02 Hex) represent hexadecimal values. For example, ASCII code “00” can be represented as (30 30 Hex) in hexadecimal notation.

■ **Communications Cables (RS-232C Cables)**

● **Communications Port Pin Arrangement on Cam Positioner End**

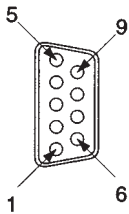

Pin No.	Symbol	Signal name	Pin No.	Symbol	Signal name
1	NC	---	6	NC	---
2	RD	Receive data	7	RS	Request to send
3	SD	Send data	8	CS	Clear to send
4	NC	---	9	NC	---
5	SG	Signal ground	Shell	FG	Frame ground

● **Assembling RS-232C Cables**

The cable length must be 5 m or less.

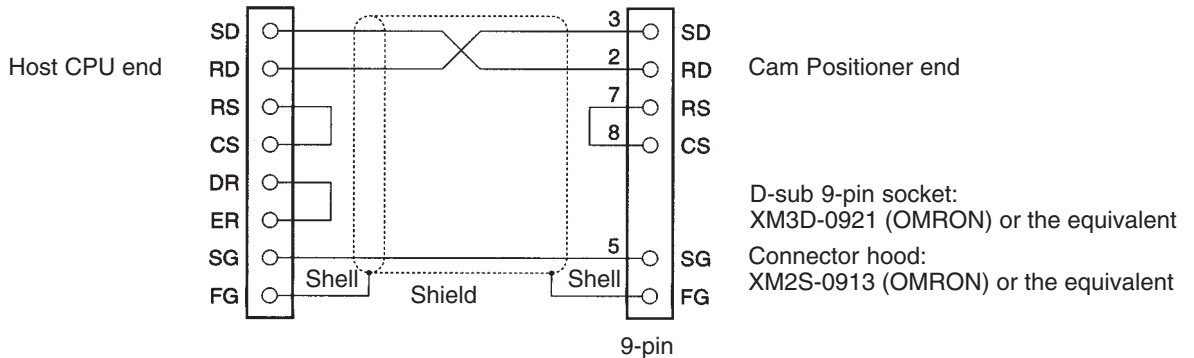

**Recommended Cables**

Name	Model (manufacturer)		Quantity	Remarks
Cable	Non-UL product	AWG28×5P IFVV-SB (Fujikura Ltd.)	1	Shielded multi-conductor cable
		CO-MA-VV-SB 5P×28AWG (Hitachi Cable, Ltd.)		
	UL product	UL2464 AWG28×5P IFS-RVV-SB (Fujikura Ltd.)		
		UL2464-SB(MA) 5P×28AWG (Hitachi Cable, Ltd.)		

**Note** The following cables can be used to connect to CS1-series Programmable Controllers.

Name	Model (manufactured by OMRON)	Length	Quantity	Remarks
Programming Device Connecting Cables (for RS-232C port)	XW2Z-200S-V	2 m	1	For connection to CS1-series PCs
	XW2Z-500S-V	5 m		

## 4-2 Command and Response Frames

### 4-2-1 Command Frame

#### ■ Transmission Protocol

When receiving a command from the host CPU, the Cam Positioner returns a response frame corresponding to the command. In other words, one response frame is returned in response to one command frame.

Command and response frames are transmitted as shown in the following illustration.

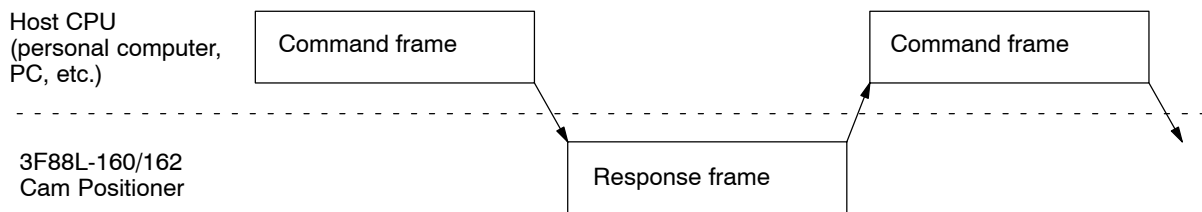

#### ■ Command Frame Structure

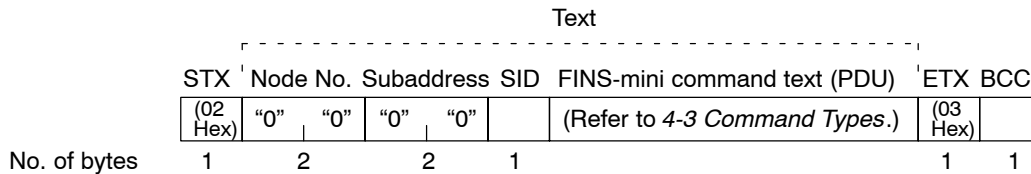

<b>STX</b>	A code signifying the beginning of a communications frame (text). Always set 02 Hex.
<b>Node No.</b>	The node number of a Cam Positioner. Always set "00."
<b>Subaddress</b>	The subaddress of a Cam Positioner. Always set "00."
<b>SID (service ID)</b>	Set the number of retries using a value from "0" to "F." (See note 1.)
<b>FINS-mini command text</b>	Set a service request PDU (protocol data unit). (See note 2.)
<b>ETX</b>	A code signifying the end of text. Always set 03 Hex.
<b>BCC (block check character)</b>	Set BCC as the calculation result of exclusive OR of the data from the node number to ETX.

**Note 1.** Operations on the Cam Positioner side are shown below.

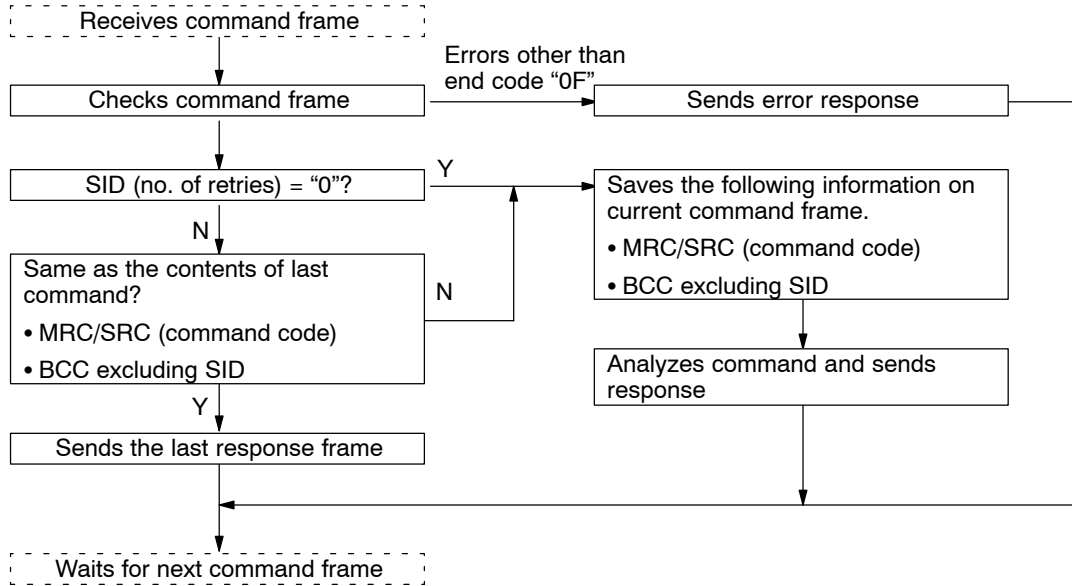

When initially sending a command frame, set SID to "0." If the corresponding response frame is abnormal, set SID to "1" and then resend the command frame.

**Note 2.** Refer to 4-3 *Command Types* for details on FINS-mini command text.

■ **Structure of FINS-mini Command Text (PDU)**

FINS-mini command text consists of MRC, SRC, and data.

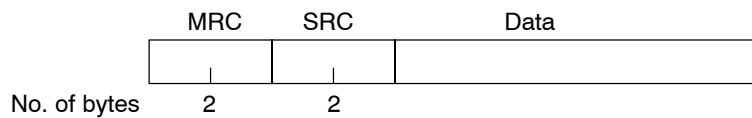

<b>MRC, SRC</b>	Main request code and subrequest code. Various commands can be set by combining these two codes.
<b>Data</b>	Settings differ depending on the command executed. Refer to 4-3 <i>Command Types</i> for details.

● **Contents of MRC and SRC**

MRC	SRC	Function	Reference section
"01"	"01"	Memory Area Read	4-3-1
"02"	"01"	Parameter Area Read	4-3-2
	"02"	Parameter Area Write	4-3-2
"05"	"01"	Controller Data Read	4-3-3
	"03"	Unit Attribute Read	4-3-4
"06"	"01"	Controller Status Read	4-3-5
"30"	"05"	Operation Command	4-3-6
"08"	"01"	Internode Echo Test	4-3-7

## 4-2-2 Response Frame

### ■ Response Frame Structure

#### ● When Command Frame is Normal

	STX	Node No.		Subaddress		End code		FINS-mini response text (PDU)	ETX	BCC
	(02 Hex)	"0"	"0"	"0"	"0"	"0"	"0"		(03 Hex)	
No. of bytes	1	2	2	2	2				1	1

<b>STX</b>	A code signifying the beginning of a communications frame (text). 02 Hex is set.
<b>Node No.</b>	The node number of a Cam Positioner. "00" is set.
<b>Subaddress</b>	The subaddress of a Cam Positioner. "00" is set.
<b>End code</b>	"00" is set at normal termination.
<b>FINS-mini response text</b>	A response PDU (protocol data unit) is set.
<b>ETX</b>	A code signifying the end of text. 03 Hex is set.
<b>BCC (block check character)</b>	BCC is set as the calculation result of exclusive OR of the data from the node number to ETX.

#### ● When FINS-mini Command is Not Executed

	STX	Node No.		Subaddress		End code		FINS-mini response text (PDU)	ETX	BCC
	(02 Hex)	"0"	"0"	"0"	"0"	"0"	"F"		(03 Hex)	
No. of bytes	1	2	2	2	2				1	1

<b>End code</b>	"0F" is set when the specified FINS-mini command is not executed. Details on non-execution can be checked with FINS response code.
-----------------	--

#### ● When Command Frame is Abnormal

	STX	Node No.		Subaddress		End code	ETX	BCC
	(02 Hex)	"0"	"0"	"0"	"0"		(03 Hex)	
No. of bytes	1	2	2	2	2	1	1	

<b>End code</b>	End code differs with the type of error.
-----------------	--

● Error Code and Error Detection Priority

Error code	Name	Meaning	Error detection priority
"00"	Normal completion	The command terminated normally.	(None)
"0F"	FINS command error	The specified FINS-mini command failed to be executed.	8
"10"	Parity error	A parity error occurred in any of the received characters.	2
"11"	Framing error	A framing error occurred in the received frame.	1
"12"	Overrun error	An overrun error occurred in any of the received characters.	3
"13"	BCC error	BCC in the received frame is invalid.	5
"14"	Format error	The FINS frame is invalid.	7
"16"	Subaddress error	The subaddress in the received frame is invalid.	6
"18"	Frame length error	The received frame exceeded the maximum number of bytes supported.	4

**Note 1.** The Cam Positioner does not respond until ETX and BCC are completed.

**Note 2.** "Error detection priority" is applicable when multiple errors occur at the same time.

■ Structure of FINS-mini Response Text (PDU)

FINS-mini response text consists of MRC, SRC, MRES, SRES, and data.

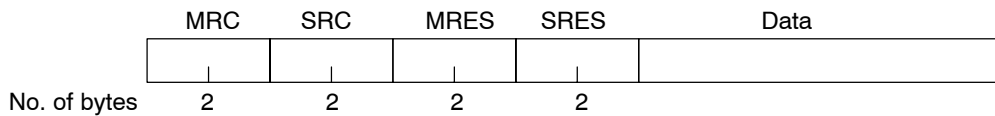

<b>MRC, SRC</b>	The same main request code and subrequest code as the command are returned.
<b>MRES, SRES</b>	Main response code and subresponse code. Processing results are indicated by combining these two codes. Each code is "00" at normal completion.
<b>Data</b>	Data differs with each command. Refer to 4-3 <i>Command Types</i> for details.

● MRES (Main Response Code)

MRES	MRES name	Meaning
"00"	Normal completion	The service was executed normally.
"04"	Service unsupported	The Cam Positioner does not support the service specified in the command.
"10"	Command format error	The command (PDU) length differs from the length specified in the service. The specified number of items does not match the number of data items to be written.
"11"	Parameter error	Because the specified parameters (data) following the command codes are incorrect, the service cannot be executed. Check the parameters.
"22"	Status error	The service cannot be executed due to the current status of the Cam Positioner.
"30"	Access error	An error relating to access to objects such as memory areas or parameter areas



● SRES (Subresponse Code)

MRES	SRES	SRES name	Meaning
"00"	"00"	Normal completion	The service was executed normally.
"04"	"01"	Unsupported command	The service specified in the command is not supported.
"10"	"01"	Too long command	The command length is above the maximum length.
	"02"	Too short command	The command length is below the minimum length.
	"03"	Item/data count mismatch	The specified number of items does not match the number of data items to be written.
"11"	"01"	Area type error	The area type (such as memory area or parameter area) is not specified correctly.
	"03"	Beginning address range error	The specified beginning address is outside the allowable range.
	"04"	End address range error	The specified end address (beginning address + the number of items) is outside the allowable range.
	"0B"	Too long response	The response length exceeds the maximum packet length.
	"00"	Other parameter errors	Other parameter errors
"22"	"03"	Operation error	Operation cannot be performed as specified. The service cannot be executed in the current mode.
"30"	"02"	Write-only	Read is impossible due to write-only area.
	"03"	Read-only	Write is impossible due to read-only area.
	"05"	No-object error	No objects such as memory areas or parameter areas exist.

### 4-3 Command Types

The following commands are used to communicate with a Cam Positioner.

- Memory Area Read: Reads the Resolver speed, present cam angle, cam output status, executing bank, and control I/O status.
- Parameter Area Read: Reads various parameters and cam programs.
- Parameter Area Write: Writes various parameters and cam programs.
- Controller Data Read: Reads the model and version.
- Unit Attribute Read: Reads the model and communications buffer size.
- Controller Status Read: Reads error codes and executing status.
- Operation Command: Changes the executing status.
- Internode Echo Test: Executes an internode echo test.

This section describes the contents of these FINS-mini command text (PDU) and FINS-mini response text (PDU). The following examples show FINS-mini response text where communications has terminated normally (MRES, SRES = "00"). For the entire frame structure or the contents of MRES and SRES where communications has terminated abnormally, refer to 4-2-1 Command Frame and 4-2-2 Response Frame.

The following symbols indicate which Cam Positioner mode can be used to execute each command.

- RUN:** Indicates a command that can be executed in RUN mode.
- PRGM:** Indicates a command that can be executed in PRGM mode.
- SET:** Indicates a command that can be executed in SET mode.

**Note** The commands that can be executed only in SET mode can also be executed in RUN mode if the Operation Command (Operating Status Change Command) is executed in RUN mode when the START signal is OFF and the status is normal.

#### 4-3-1 Memory Area Read (RUN)

##### ■ Structure of FINS-mini Command Text (PDU)

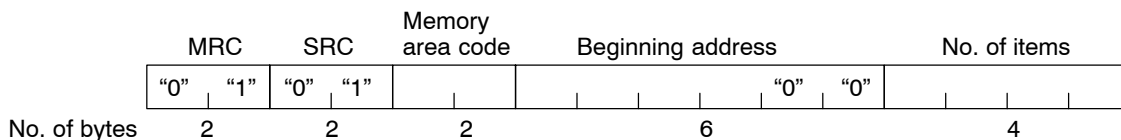

**Note 1.** The memory area code is divided into the following three types.  
 40: Memory area data in byte (8 bits) units  
 80: Memory area data in word (16 bits) units  
 C0: Memory area data in long word (32 bits) units  
 Set the memory area code as ASCII code "40" (3430 Hex), "80" (3830 Hex), or "C0" (4330 Hex).

**Note 2.** Set the beginning address as a four-digit ASCII code + “00.”  
For example, the present cam angle (address 0002) is set as “000200.”

**Note 3.** In “No. of items,” set the number of items in the unit specified for the memory area code.  
For example, revolver speed is memory area data in word units, so the number of items is 1 (set “0001”). Control I/O status is memory area data in byte units, so the number of items is 2 when both input and output are read.

■ Structure of FINS-mini Response Text (PDU)

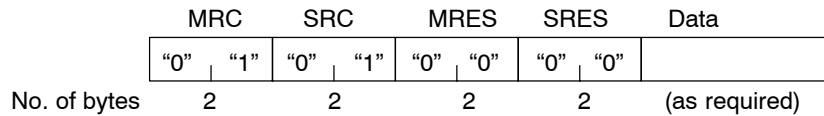

■ Contents of Memory Area

Address	Memory area code	Name	Explanation																																													
0000 0001	80	Resolver Speed	Current Resolver speed (r/min): 4-digit BCD 0000 to 1600 (resolution: 360 divisions per revolution) 0000 to 0800 (resolution: 720 divisions per revolution) Address 0000: Leftmost byte Address 0001: Rightmost byte																																													
0002 0003	80	Present Cam Angle	Present cam angle (in set unit): 4-digit BCD 0000 to 0359 (resolution: 360 divisions per revolution) 0000 to 0719 (resolution: 720 divisions per revolution) Address 0002: Leftmost byte Address 0003: Rightmost byte																																													
0004 to 0007	C0	Cam Output Status	Cam output status 0: Output OFF 1: Output ON  <table border="1" style="margin-left: 20px; border-collapse: collapse; width: 80%;"> <tr> <td></td> <td colspan="4" style="text-align: center;">b7</td> <td colspan="4" style="text-align: center;">b0</td> </tr> <tr> <td>Address 0007</td> <td>CAM8</td><td>CAM7</td><td>CAM6</td><td>CAM5</td><td>CAM4</td><td>CAM3</td><td>CAM2</td><td>CAM1</td> </tr> <tr> <td>Address 0006</td> <td>CAM16</td><td>CAM15</td><td>CAM14</td><td>CAM13</td><td>CAM12</td><td>CAM11</td><td>CAM10</td><td>CAM9</td> </tr> <tr> <td>Address 0005</td> <td>CAM24</td><td>CAM23</td><td>CAM22</td><td>CAM21</td><td>CAM20</td><td>CAM19</td><td>CAM18</td><td>CAM17</td> </tr> <tr> <td>Address 0004</td> <td>CAM32</td><td>CAM31</td><td>CAM30</td><td>CAM29</td><td>CAM28</td><td>CAM27</td><td>CAM26</td><td>CAM25</td> </tr> </table>		b7				b0				Address 0007	CAM8	CAM7	CAM6	CAM5	CAM4	CAM3	CAM2	CAM1	Address 0006	CAM16	CAM15	CAM14	CAM13	CAM12	CAM11	CAM10	CAM9	Address 0005	CAM24	CAM23	CAM22	CAM21	CAM20	CAM19	CAM18	CAM17	Address 0004	CAM32	CAM31	CAM30	CAM29	CAM28	CAM27	CAM26	CAM25
	b7				b0																																											
Address 0007	CAM8	CAM7	CAM6	CAM5	CAM4	CAM3	CAM2	CAM1																																								
Address 0006	CAM16	CAM15	CAM14	CAM13	CAM12	CAM11	CAM10	CAM9																																								
Address 0005	CAM24	CAM23	CAM22	CAM21	CAM20	CAM19	CAM18	CAM17																																								
Address 0004	CAM32	CAM31	CAM30	CAM29	CAM28	CAM27	CAM26	CAM25																																								
0008	40	Executing Bank	Executing bank No.: 2-digit BCD 01 to 08 (resolution: 360 divisions per revolution) 01 to 04 (resolution: 720 divisions per revolution)																																													

Address	Memory area code	Name	Explanation																
000A 000B	40	Control I/O Status	Control I/O signal status output 0: OFF 1: ON Address 000A: Control input <div style="display: flex; justify-content: space-between; margin: 5px 0;"> <span>b7</span> <span>b0</span> </div> <table border="1" style="width: 100%; text-align: center; border-collapse: collapse;"> <tr> <td style="width: 12.5%;">START</td> <td style="width: 12.5%;">---</td> <td style="width: 12.5%;">---</td> <td style="width: 12.5%;">---</td> <td style="width: 12.5%;">TRIG</td> <td style="width: 12.5%;">BANK3</td> <td style="width: 12.5%;">BANK2</td> <td style="width: 12.5%;">BANK1</td> </tr> </table> Address 000B: Control output <div style="display: flex; justify-content: space-between; margin: 5px 0;"> <span>b7</span> <span>b0</span> </div> <table border="1" style="width: 100%; text-align: center; border-collapse: collapse;"> <tr> <td style="width: 12.5%;">---</td> <td style="width: 12.5%;">---</td> <td style="width: 12.5%;">---</td> <td style="width: 12.5%;">---</td> <td style="width: 12.5%;">---</td> <td style="width: 12.5%;">ERROR</td> <td style="width: 12.5%;">M•DET</td> <td style="width: 12.5%;">RUN</td> </tr> </table> <p><b>Note</b> Bits indicated by “---” are set to 0.</p>	START	---	---	---	TRIG	BANK3	BANK2	BANK1	---	---	---	---	---	ERROR	M•DET	RUN
START	---	---	---	TRIG	BANK3	BANK2	BANK1												
---	---	---	---	---	ERROR	M•DET	RUN												

**Note 1.** Specify the beginning address of FINS-mini command text as 4-digit ASCII code + “00.” For example, when reading the executing bank, specify “000800” as the beginning address.

**Note 2.** The data structure shown in the “Explanation” column is the one inside the Cam Positioner. If the data is read through CompoWay/F communications, it will be converted into ASCII code. For example, when the Resolver speed is 800 r/min, data is stored as 08 Hex (leftmost byte: Address 0000) and 00 Hex (rightmost byte: Address 0001) inside the Cam Positioner. This data will be read as ASCII code “0800” (30 38 30 30 Hex) during communications. When CAM1 to CAM8 are all ON, hexadecimal value FF is written to address 0004, but it will be read as ASCII code “FF” (46 46 Hex) during communications.

### 4-3-2 Parameter Area Read/Write (SET)

#### ■ Parameter Area Read

##### ● Structure of FINS-mini Command Text (PDU)

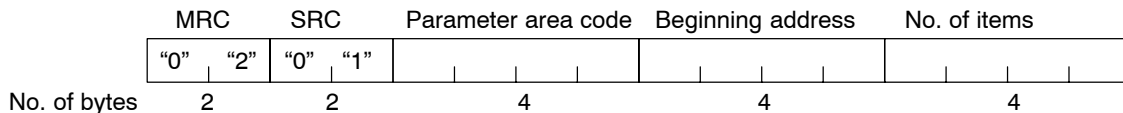

**Note 1.** The parameter area code is divided into the following three types.  
 4000: Parameters in byte (8 bits) units  
 8000: Parameters in word (16 bits) units  
 C000: Parameters in long word (32 bits) units  
 Set the parameter area code as ASCII code “4000,” “8000,” or “C000.”

**Note 2.** Set the beginning address as 4-digit ASCII code. For example, to read an origin compensation value from address 8000, set “8000.”

**Note 3.** In “No. of items,” set the number of items in the unit specified for the parameter area code. For example, resolution/compensation settings are parameters in byte units, so the number of items is 1. Origin compensation values are parameters in word units, so the number of items is 1. Cam programs for cams 1 to 8 of bank 1 are parameters in byte units, so the number of items is 720.

To set the number of items, represent it as a 4-digit hexadecimal number first, set the leftmost bit to 1, then convert the hexadecimal code into ASCII code. For example, when the number of items is 720, represent it as hexadecimal number 02D0 Hex first, set the leftmost bit to 1 to obtain hexadecimal number 82D0 Hex, then set ASCII code "82D0" (38 32 44 30 Hex).

● Structure of FINS-mini Response Text (PDU)

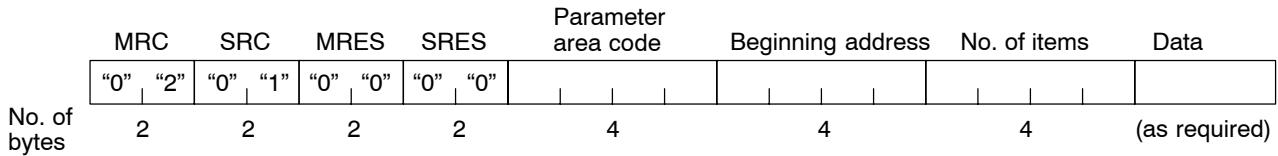

**Note** The contents of MRC, SRC, parameter area code, beginning address, and No. of items are the same as those of the command.

■ Parameter Area Write

● Structure of FINS-min Command Text (PDU)

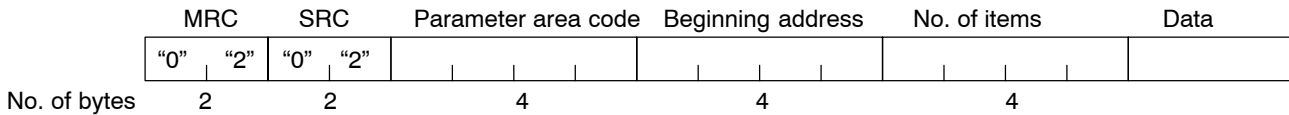

**Note 1.** The parameter area code is divided into the following three types.

4000: Parameters in byte (8 bits) units

8000: Parameters in word (16 bits) units

C000: Parameters in long word (32 bits) units

Set the parameter area code as ASCII code "4000," "8000," or "C000."

**Note 2.** Set the beginning address as 4-digit ASCII code. For example, to write an origin compensation value to address 8000, set "8000."

**Note 3.** In "No. of items," set the number of items in the unit specified for the parameter area code. For example, resolution/compensation settings are parameters in byte units, so the number of items is 1. Origin compensation values are parameters in word units, so the number of items is 1. Cam programs for cams 1 to 8 of bank 1 are parameters in byte units, so the number of items is 720.

To set the number of items, represent it as a 4-digit hexadecimal number first, set the leftmost bit to 1, then convert the hexadecimal code into ASCII code. For example, when the number of items is 720, represent it as hexadecimal number 02D0 Hex first, set the leftmost bit to 1 to obtain hexadecimal number 82D0 Hex, then set ASCII code "82D0" (38 32 44 30 Hex).

**Note 4.** In "Data," set all data as ASCII code.

Example 1: Writing 200 as an origin compensation value

Parameter area code: "8000"; Beginning address: "0002"; No. of items: "8001"; Data: "0200"

Example 2: Clearing cam programs

Parameter area code: "4000"; Beginning address: "0100"; No. of items: "8001"; Data: "20"

● Structure of FINS-mini Response Text (PDU)

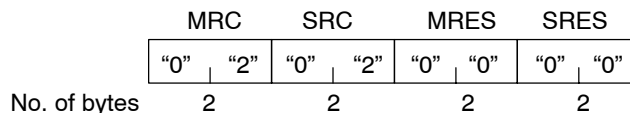

■ Contents of Parameter Area

Address	Parameter area code	Name	Explanation	Default
0000	4000	Resolution/Compensation Settings	Resolution selection, and the presence or absence of backlash and advance angle compensations. 	00
0002 0003	8000	Origin Compensation Value	Origin compensation value: 4-digit BCD from 0000 to 0359 (0719) Address 0002: Leftmost byte Address 0003: Rightmost byte	0000
0004 0005	8000	Backlash Compensation Value	Backlash compensation value: 4-digit BCD from 0000 to 0359 (0719) Address 0004: Leftmost byte Address 0005: Rightmost byte	0000
0006 to 0009	C000	Advance Angle Compensation Value 1	Advance angle compensation value 1: 4-digit BCD Addresses 0006 and 0007: Speed data 0000 to 1600 (0800) Addresses 0008 and 0009: Angle data 0000 to 0359 (0719)	0000 0000
000A to 000D	C000	Advance Angle Compensation Value 2	Advance angle compensation value 2: 4-digit BCD Addresses 000A and 000B: Speed data 0000 to 1600 (0800) Addresses 000C and 000D: Angle data 0000 to 0359 (0719)	0000 0000
000E 000F	8000	Advance Angle Compensation Value 3	Advance angle compensation value 3: 4-digit BCD from 0000 to 0359 (0719) Address 000E: Leftmost byte Address 000F: Rightmost byte	0000
0010 to 0013	C000	Bank 1 Cam Data Protect Setting	Cam data protect setting 0: Not protected 1: Protected 	00 00 00 00

Address	Parameter area code	Name	Explanation	Default
0014 to 0017	C000	Bank 1 One-direction Function Setting	One-direction function setting 0: OFF 1: ON  b7 <span style="float: right;">b0</span> Address 0017: CAM8 CAM7 CAM6 CAM5 CAM4 CAM3 CAM2 CAM1 Address 0016: CAM 16 CAM 15 CAM 14 CAM 13 CAM 12 CAM 11 CAM 10 CAM9 Address 0015: CAM 24 CAM 23 CAM 22 CAM 21 CAM 20 CAM 19 CAM 18 CAM 17 Address 0014: CAM 32 CAM 31 CAM 30 CAM 29 CAM 28 CAM 27 CAM 26 CAM 25	00 00 00 00
0018 to 001B	C000	Bank 1 Rotation Direction Setting	Rotation direction setting 0: Forward 1: Reverse  b7 <span style="float: right;">b0</span> Address 001B: CAM8 CAM7 CAM6 CAM5 CAM4 CAM3 CAM2 CAM1 Address 001A: CAM 16 CAM 15 CAM 14 CAM 13 CAM 12 CAM 11 CAM 10 CAM9 Address 0019: CAM 24 CAM 23 CAM 22 CAM 21 CAM 20 CAM 19 CAM 18 CAM 17 Address 0018: CAM 32 CAM 31 CAM 30 CAM 29 CAM 28 CAM 27 CAM 26 CAM 25	00 00 00 00
0020 to 002B	C000	Bank 2 Cam Data Protect Setting, One-direction Function Setting, and Rotation Direction Setting	Same as for bank 1. Addresses 0020 to 0023: Bank 2 cam data protect setting Addresses 0024 to 0027: Bank 2 one-direction function setting Addresses 0028 to 002B: Bank 2 rotation direction setting	All 00
0030 to 003B	C000	Bank 3 Cam Data Protect Setting, One-direction Function Setting, and Rotation Direction Setting	Same as for bank 1. Addresses 0030 to 0033: Bank 3 cam data protect setting Addresses 0034 to 0037: Bank 3 one-direction function setting Addresses 0038 to 003B: Bank 3 rotation direction setting	All 00
0040 to 004B	C000	Bank 4 Cam Data Protect Setting, One-direction Function Setting, and Rotation Direction Setting	Same as for bank 1. Addresses 0040 to 0043: Bank 4 cam data protect setting Addresses 0044 to 0047: Bank 4 one-direction function setting Addresses 0048 to 004B: Bank 4 rotation direction setting	All 00

Address	Parameter area code	Name	Explanation	Default
0050 to 005B	C000	Bank 5 Cam Data Protect Setting, One-direction Function Setting, and Rotation Direction Setting	Same as for bank 1. Addresses 0050 to 0053: Bank 5 cam data protect setting Addresses 0054 to 0057: Bank 5 one-direction function setting Addresses 0058 to 005B: Bank 5 rotation direction setting	All 00
0060 to 006B	C000	Bank 6 Cam Data Protect Setting, One-direction Function Setting, and Rotation Direction Setting	Same as for bank 1. Addresses 0060 to 0063: Bank 6 cam data protect setting Addresses 0064 to 0067: Bank 6 one-direction function setting Addresses 0068 to 006B: Bank 6 rotation direction setting	All 00
0070 to 007B	C000	Bank 7 Cam Data Protect Setting, One-direction Function Setting, and Rotation Direction Setting	Same as for bank 1. Addresses 0070 to 0073: Bank 7 cam data protect setting Addresses 0074 to 0077: Bank 7 one-direction function setting Addresses 0078 to 007B: Bank 7 rotation direction setting	All 00
0080 to 008B	C000	Bank 8 Cam Data Protect Setting, One-direction Function Setting, and Rotation Direction Setting	Same as for bank 1. Addresses 0080 to 0083: Bank 8 cam data protect setting Addresses 0084 to 0087: Bank 8 one-direction function setting Addresses 0088 to 008B: Bank 8 rotation direction setting	All 00



Address	Parameter area code	Name	Explanation	Default
0100	4000	Clear Command	<p>Program Clear, Parameter Clear, and Parameter Update</p> <p> <b>Note</b> 1. Setting the respective bits to 1 executes Program Clear, Parameter Clear, and Parameter Update. When the commands are completed, the Cam Positioner sets these bits to 0. Therefore, after the Clear Command is submitted, reading address 0100 allows the user to check whether the command is being executed or completed.                 </p> <p> <b>Note</b> 2. When these bits are turned ON (set to 1) at the same time, Program Clear, Parameter Clear, and Parameter Update will be processed in this order. (The specified commands will be all processed.)                 </p> <p> <b>Note</b> 3. Executing Program Clear erases all cam programs. (If there is even one cam for which cam data protect has been set, Program Clear will not be executed.)                 </p> <p> <b>Note</b> 4. Executing Parameter Clear initializes all parameters.                 </p> <p> <b>Note</b> 5. Executing Parameter Update enables the parameters that are made valid after the power is turned OFF and then ON. (Therefore, if Parameter Update is used, there will be no need to turn the power OFF and then ON when making the parameters valid.)                 </p>	00
0102	4000	Function Level Selection Data	<p>Function level selection data: 2-digit BCD</p> <p>00: Function level 0 (for monitor only)</p> <p>01: Function level 1 (for basic operations and monitor only)</p> <p>02: Function level 2 (for all functions)</p>	01

Address	Parameter area code	Name	Explanation	Default
1000 to 12CF	4000	Cam Programs for Cams 1 to 8 of Bank 1	<p>Program status                      0: Output OFF                      1: Output ON</p>	All 00
1300 to 15CF	4000	Cam Programs for Cams 9 to 16 of Bank 1	<p>Program status                      0: Output OFF                      1: Output ON</p>	All 00
1600 to 18CF	4000	Cam Programs for Cams 17 to 24 of Bank 1	<p>Program status                      0: Output OFF                      1: Output ON</p>	All 00

Address	Parameter area code	Name	Explanation	Default
1900 to 1BCF	4000	Cam Programs for Cams 25 to 32 of Bank 1	Program status 0: Output OFF 1: Output ON 	All 00
2000 to 2BCF	4000	Cam Programs of Bank 2	Same as for bank 1	All 00
3000 to 3BCF	4000	Cam Programs of Bank 3	Same as for bank 1	All 00
4000 to 4BCF	4000	Cam Programs of Bank 4	Same as for bank 1	All 00
5000 to 5BCF	4000	Cam Programs of Bank 5	Same as for bank 1	All 00
6000 to 6BCF	4000	Cam Programs of Bank 6	Same as for bank 1	All 00
7000 to 7BCF	4000	Cam Programs of Bank 7	Same as for bank 1	All 00
8000 to 8BCF	4000	Cam Programs of Bank 8	Same as for bank 1	All 00

**Note 1.** The 3F88L-160 (16-point type) has an area for storing cam programs for cams 17 to 32, but the contents of these programs cannot be displayed from the Unit.

**Note 2.** Even if the resolution is set to 360 divisions per revolution, there is an area for storing the state of cam angles 360 to 719.

### 4-3-3 Controller Data Read (RUN, PRGM, SET)

Reads the model and version of the Controller.

#### ■ Structure of FINS-mini Command Text (PDU)

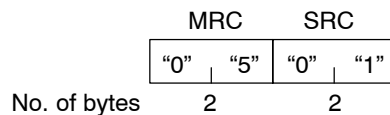

■ Structure of FINS-mini Response Text (PDU)

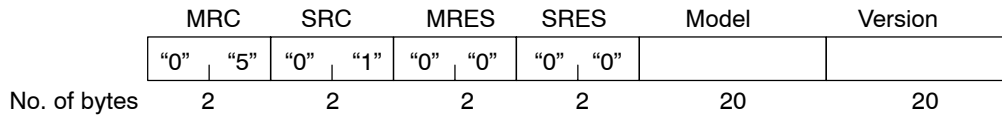

**Note 1.** The model is returned as "3F88L-160 \_\_\_\_\_" (16-point type) or "3F88L-162 \_\_\_\_\_" (32-point type). " \_ " represents a space code (20 Hex).

**Note 2.** The version is returns as "Ver.□.□ \_\_\_\_\_".

4-3-4 Unit Attribute Read (RUN, PRGM, SET)

Reads the model and communications buffer size (either send or receive buffer size, whichever smaller).

■ Structure of FINS-mini Command Text (PDU)

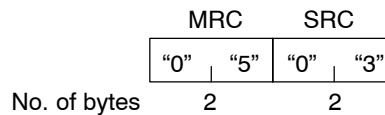

■ Structure of FINS-mini Response Text (PDU)

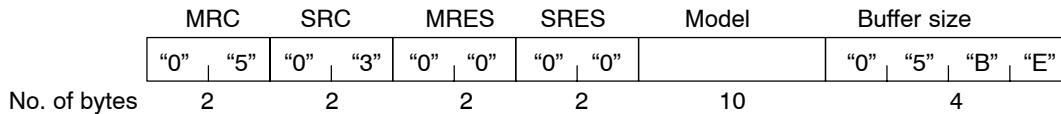

**Note 1.** The model is returned as "3F88L-160\_" (16-point type) or "3F88L-162\_" (32-point type). " \_ " represents a space code (20 Hex).

**Note 2.** The communications buffer size of the Cam Positioner is "05BE" (1,470 bytes).

4-3-5 Controller Status Read (RUN, PRGM, SET)

Reads the error codes and executing status of the Controller.

■ Structure of FINS-mini Command Text (PDU)

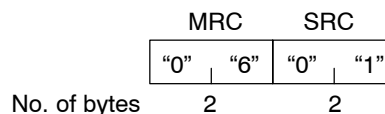

■ Structure of FINS-mini Response Text (PDU)

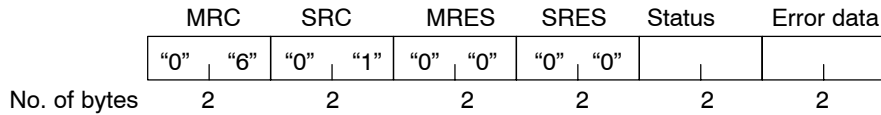

**Note 1.** "Status" is returned as the following one-byte data that is converted into ASCII code.

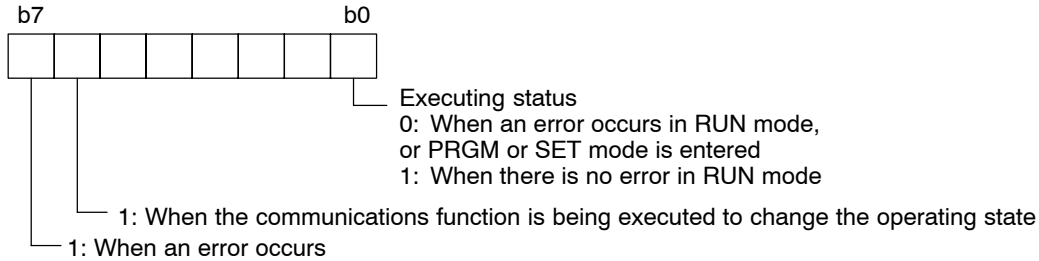

Bit 0 (executing status) is also set to 1 when the communications function is being executed to change the operating state (such as parameter settings) in RUN mode. For example, when the operating state is changed in RUN mode and there are no errors, "Status" will be set to "41."

**Note 2.** "Error data" is returned as an error code (\*\* of E-\*\*).

4-3-6 Operation Command (RUN)

- Executing the Operation Command (Operating State Change Command) with command code "01" allows parameters to be changed while in RUN mode.
- The Operation Command can be used to change parameters only when the Cam Positioner is in RUN mode, the START signal is OFF, and there are no errors.
- Execute the Operation Command with command code "00" to return from the state in which parameters can be changed to RUN mode. This command is valid only when the Cam Positioner is in RUN mode, the START signal is OFF, and there are no errors.
- If the mode selection switch on the Cam Positioner is operated in the state in which parameters can be changed, communications will be interrupted and the mode specified by the switch will be entered.

■ Structure of FINS-mini Command Text (PDU)

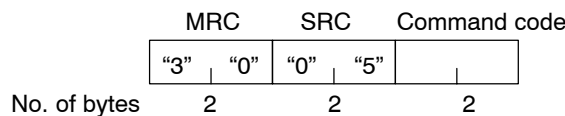

**Note** The meaning of the command code is as follows:

- "01": Start (Switches from RUN mode to the state in which parameters can be changed)
- "00": Stop (Switches from the state in which parameters can be changed to RUN mode)

■ Structure of FINS-mini Response Text (PDU)

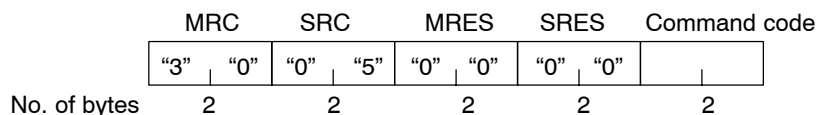

### 4-3-7 Internode Echo Test (*RUN, PRGM, SET*)

Performs an internode echo test between the host CPU and the Cam Positioner.

#### ■ Structure of FINS-mini Command Text (PDU)

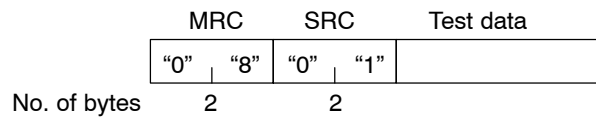

**Note** Any data except 02 Hex (start) and 03 Hex (stop) can be used for internode echo tests.

#### ■ Structure of FINS-mini Response Text (PDU)

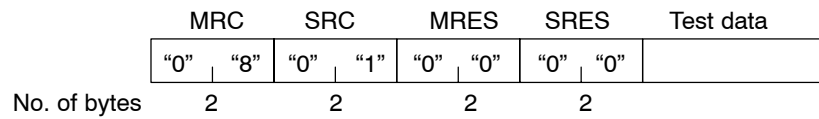

## 4-4 Executing CompoWay/F Commands with Protocol Macros

CompoWay/F communications can be easily performed by using the protocol macros of the CS1-series Serial Communications Boards and Units. The Serial Communications Boards and Units are provided with standard CompoWay/F communication protocol called “CompoWay/F Master,” which allows the Programmable Controller to execute CompoWay/F commands for the 3F88L-160/162 Cam Positioner without having to be aware of CompoWay/F protocols.

### ■ Configuration

- SYSMAC CS1-series Programmable Controller (CompoWay/F Master)

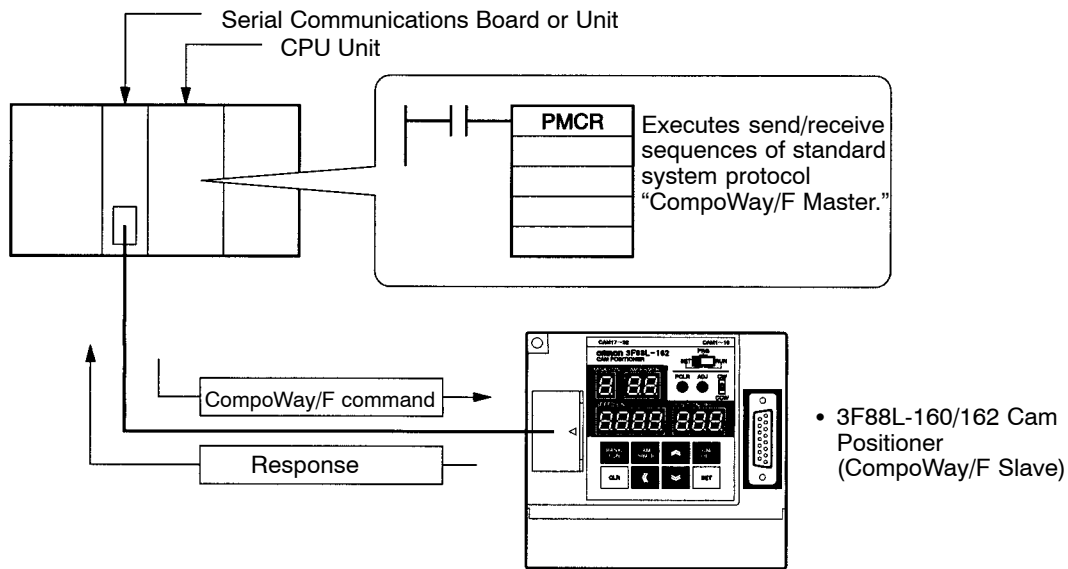

- 3F88L-160/162 Cam Positioner (CompoWay/F Slave)

### ■ System Components

Item	Model
CS1-series Programmable Controller	High-speed type: CS1H-CPU67/CPU66/CPU65/CPU64/CPU63 Standard type: CS1G-CPU45/CPU44/CPU43/CPU42
Serial Communications Board	CS1W-SCB21 (RS-232C × 2 ports) CS1W-SCB41 (RS-232C × 1 port, RS-422/485 × 1 port)
Serial Communications Unit	CS1W-SCU21 (RS-232C × 2 ports)
Programming Device Connecting Cables (for RS-232C port)	XW2Z-200S-CV (2 m) XW2Z-500S-CV (5 m)

**Note** The following support tool is required to trace the executing status of protocol macros.  
WS02-PSTC1-E CX-Protocol

■ **Manuals for Related Devices and Support Tools**

Title	Number
SYSMAC CS1-series Programmable Controllers Operation Manual	W339
SYSMAC CS1-series Programmable Controllers Programming Manual	W340
SYSMAC CS1-series Serial Communications Boards/Unit Operation Manual	W336
CX-Protocol Operation Manual	W344

■ **Standard System Protocols (Sequence Numbers)**

- To execute a CompoWay/F command for the Cam Positioner, execute sequence No. 600 (#0258) or sequence No. 602 (#025A) within the standard system protocol by using a PMCR instruction.
- The following table shows a relationship between sequence numbers and CompoWay/F commands for the Cam Positioner.

Standard system protocol	CompoWay/F commands for Cam Positioner
Sequence No. 600 (#0258): Data transfer with ASCII code conversion With response	<ul style="list-style-type: none"> <li>• Memory Area Read (0101 Hex)</li> <li>• Parameter Area Write (0202 Hex)</li> <li>• Parameter Area Read (0201 Hex)</li> <li>• Controller Status Read (0601 Hex)</li> <li>• Operation Command (3005 Hex)</li> </ul>
Sequence No. 602 (#025A): Data transfer without ASCII code conversion With response	<ul style="list-style-type: none"> <li>• Controller Data Read (0501 Hex)</li> <li>• Unit Attribute Read (0503 Hex)</li> <li>• Internode Echo Test (0801 Hex)</li> </ul>

■ **Using CompoWay/F Standard System Protocol**

- To send CompoWay/F commands from a CS1-series Programmable Controller to a Cam Positioner by using protocol macros, execute the send-receive sequences of the CompoWay/F Master protocol provided as a standard system protocol by using protocol macro (PMCR) instructions within the ladder program of the CS1-series CPU Unit.
- Use the following procedure to specify PMCR instructions.
  1. Specify the sequence number as a hexadecimal value in the second operand of the PMCR instruction.
  2. The first table *Send Data Word Allocations (Third Operand of PMCR Instruction)* on the following page shows the data format of operand S and subsequent operands in the PMCR instruction. Specify this format of data in operand S and subsequent operands.
  3. The second table *Receive Data Word Allocations (Fourth Operand of PMCR Instruction)* on the following page shows the data format of operand D and subsequent operands in the PMCR instruction. This format of data will be set in operand D and subsequent operands. Normally, set 0000 Hex as the default value in D+0.

PMCR	
C1	Control data: Communications port No., serial port No., destination unit address
C2	Control data: Send-receive sequence No. (0258 Hex for sequence No. 600, 025A Hex for sequence No. 602)
S	First word No. of send data
D	First word No. of received data storage



● Control Data C1

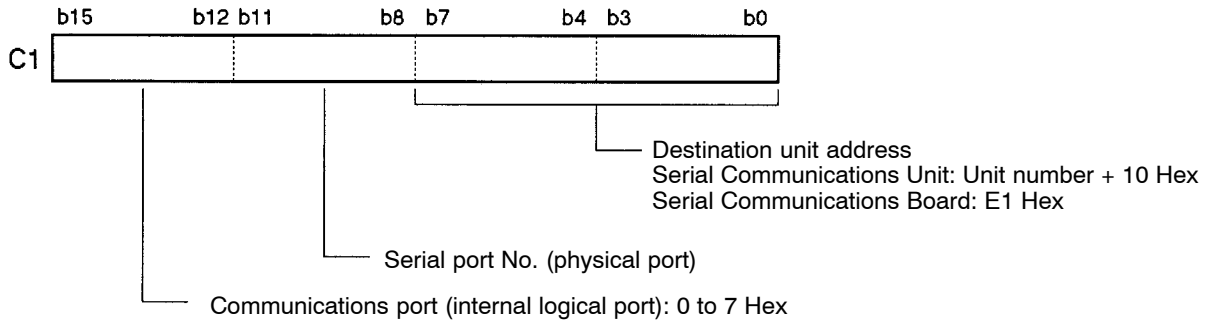

● Send Data Word Allocations (Third Operand of PMCR Instruction)

Word No.	Data format		Data
S+0	No. of send data words (4-digit Hex)		Set the number of words of data to be sent (from S+0 to the end of the data). Setting range: 0005 Hex to 00FA Hex (5 to 250 in decimal)
S+1	Reserved	Node No. (2-digit BCD)	The node number of the Cam Positioner is 00 Hex. Set 0000 Hex in S+1.
S+2	MRC (2-digit Hex)	SRC (2-digit Hex)	Set the command code of the service to be used. (Refer to 4-2-1 Command Frame.)
S+3	No. of send data bytes (4-digit Hex)		Set the amount of data that follows the command code (MRC, SRC) and ends immediately before ETX. Setting range: 0000 Hex to 0492 Hex (0 to 984 in decimal) For sequence No. 600, set the number of bytes of data that has been converted into ASCII code (that is, the number of bytes set in S+4 and subsequent operands multiplied by 2). For sequence No. 602, set the number of bytes set in S+4 and subsequent operands.
S+4 onwards	Send data (4-digit Hex)		Set the data to be sent. For sequence No. 600, data that has been converted from hexadecimal to ASCII code is sent. For sequence No. 602, data is sent without being converted.

● Receive Data Word Allocations (Fourth Operand of PMCR Instruction)

Word No.	Data format	Data
D+0	No. of received data words (4-digit Hex)	The number of received data words (from D+0 to the end of received data) is stored. Range: 0003 Hex to 00FA Hex (3 to 250 in decimal)
D+1	Response code (4-digit Hex)	Response code (MRES, SRES) is stored as a 4-digit hexadecimal value.
D+2	Received data (4-digit Hex)	Data that follows the response code (MRES, SRES) and ends immediately before ETX is stored. For sequence No. 600, data that starts from the largest word number of the received data words (D + number of received data words + 1) and continues until D+2 in descending order is stored. For sequence No. 602, data is stored sequentially starting from D+2.

■ Examples of Executing CompoWay/F Commands with Protocol Macros

● Examples of Monitoring Resolver Speed and Present Cam Angle

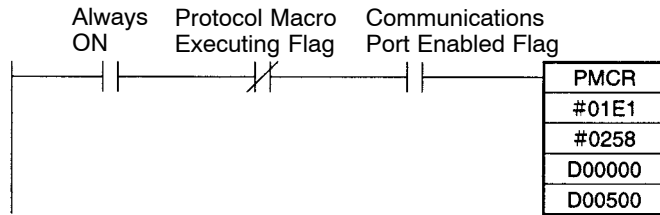

PMCR	Protocol macro instruction
#01E1	Control data: Communications port No. 0, serial port No. 1, and inner board are used.
#0258	Control data: Send-receive sequence No. 600 (with ASCII code conversion and response) is set.
D00000	First word No. of send data: DM00000 is set.
D00500	First word No. of received data storage: DM00500 is set.

Send Data Word Allocations

DM address	Data	
D00000	0007	No. of send data words: There are seven words from D00000 to D00006, so 0007 Hex is set.
D00001	0000	Node No.: The node number of Cam Positioner is 00, so 000 Hex is set.
D00002	0101	MRC, SRC: Memory Area Read is used, so MRC = 01 Hex and SRC = 01 Hex are set. (Hexadecimal settings are converted into ASCII code during communications.)
D00003	000C	No. of send data bytes: If send data from D00004 to D00006 (6 bytes) are converted into ASCII code, it will become 12 bytes. So, 000C Hex is set.
D00004	8000	Data part of FINS-mini command text (PDU): Data is set in Hex. The settings will be converted into ASCII code during communications.
D00005	0000	Same as above.
D00006	0002	Same as above.

Note Data part of FINS-mini command text (PDU)

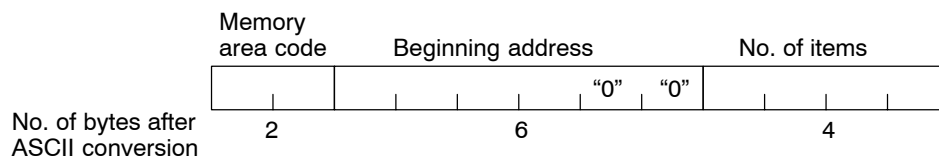

Memory area code: The memory area code for Resolver speed and present cam angle is "80."  
 Beginning address: The address for Resolver speed is "0000."  
 No. of items: There are two items (Resolver speed and present cam angle), so "0002" is set.

Receive Data Word Allocations

DM address	Data	
D00500	0004	No. of received data words: There are four words from D00500 to D00503, so 0004 Hex is stored.
D00501	0000	Response code: MRES = 00 and SRES = 00 are stored at normal completion.
D00502	0359	Received data: The present cam angle (359 in this example) is stored after being converted from ASCII code into a hexadecimal value.
D00503	0800	Received data: The cam speed (800 r/min in this example) is stored after being converted from ASCII code into a hexadecimal value.

**Note** For sequence No. 600, received data is stored from the largest word number sequentially to D+2. In the above example, Resolver speed data “08” and “00” and present cam angle data “03” and “59” are received as ASCII data in this order, and D00503 and D00502 are converted into hexadecimal values in this order.

• **Examples of Monitoring Errors**

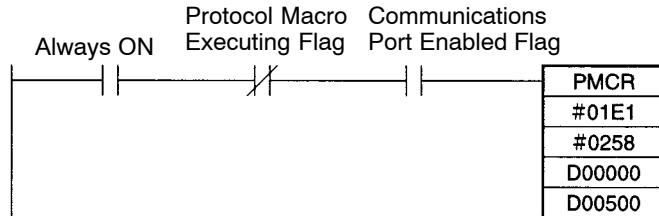

PMCR	Protocol macro instruction
#01E1	Control data: Communications port No. 0, serial port No. 1, and inner board are used.
#0258	Control data: Send-receive sequence No. 600 (with ASCII code conversion and response) is set.
D00000	First word No. of send data: DM00000 is set.
D00500	First word No. of received data storage: DM00500 is set.

**Send Data Word Allocations**

DM address	Data	
D00000	0004	No. of send data words: There are four words from D00000 to D00003, so 0004 Hex is set.
D00001	0000	Node No.: The node number of Cam Positioner is 00, so 0000 Hex is set.
D00002	0601	MRC, SRC: Controller Status Read is used, so MRC = 06 and SRC = 01 are set.
D00003	0000	No. of sent data bytes: There is no data to be sent, so 0000 Hex is set.

**Receive Data Word Allocations**

DM address	Data	
D00500	0003	No. of received data words: There are three words from D00500 to D00502, so 0003 Hex is stored.
D00501	0000	Response code: MRES = 00 and SRES = 00 are stored at normal completion.
D00502	8010	Received data: “Status” (80 in this example) and “error data” (10 in this example) are stored after being converted from ASCII code to hexadecimal values.

**Note 1.** The content of “Status” is as follows:

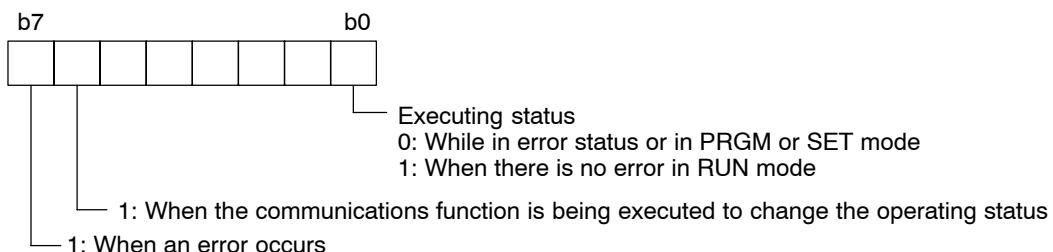

In this example, “status” = 80 indicates that an error has occurred.

**Note 2.** An error code is stored when an error has occurred. In this example, “error data” = 10 indicates a Resolver disconnection error.

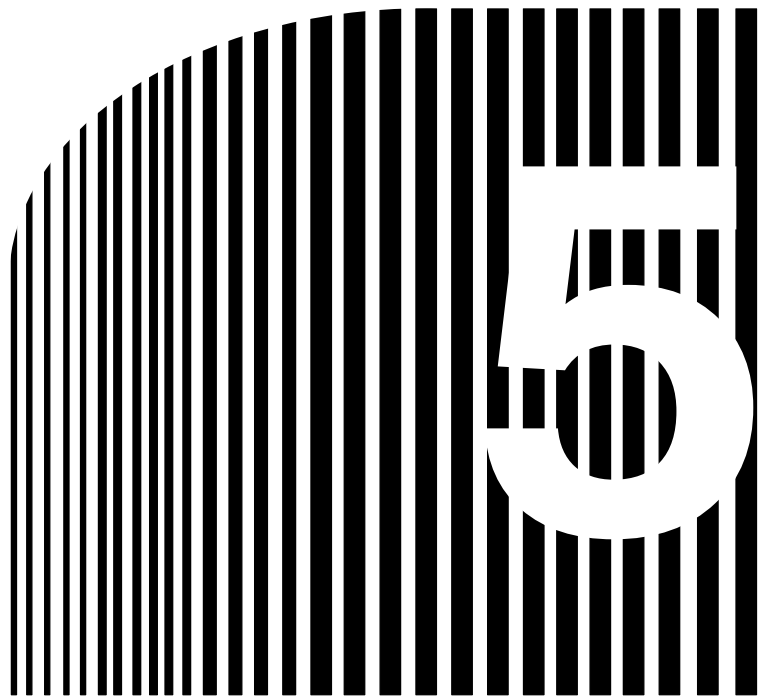

## Chapter 5

### • Operation •

- 5-1 Diagnosis using Error Codes
- 5-2 CompoWay/F Communications Errors
- 5-3 Troubleshooting
- 5-4 Inspection and Maintenance
- 5-5 Cam Positioner Replacement

## 5-1 Diagnosis using Error Codes

If the 3F88L-160/162 Cam Positioner detects an error, the error code (E-\*\*) will appear in the SPEED/ON display. All control outputs (RUN, M-DET, ERROR) will turn OFF. The cam output will vary depending on the output hold function settings. The Cam Positioner errors will be detected during the following processes.

- At power ON: Hardware check, program check, and power interrupt check during program write/save.
- During operation: Error check in RUN mode.
- During programming: ON region duplication errors in PRGM mode, cam data protect input prohibit checking, etc.
- While setting parameters: Communications error checks in SET mode.

If an error code is displayed, determine the cause and take appropriate countermeasures.

### ■ Errors Codes and Countermeasures

**Note** The “●” mark in the cam output column indicates that cam outputs are turned OFF regardless of the output hold settings. The “○” mark indicates that if output hold is set, the output status immediately before the error was generated will be maintained. If output hold is not set, cam outputs will be turned OFF. (Refer to 3-6-9 Output Hold Function for information.)

Error code	Error name	Description	Cam output	Probable cause	Possible solution	Error reset method
E-00	Hardware failure	Memory read/write check error when power turned ON.	●	Malfunction due to noise (system recovers when power is turned ON again.)	Check if noise has been generated when or after the power was turned ON and take appropriate countermeasures against the noise.	Turn the power ON again.
				The Cam Positioner is malfunctioning (system does not recover when power is turned ON again.)	Replace the Cam Positioner.	---

Error code	Error name	Description	Cam output	Probable cause	Possible solution	Error reset method
E-01	Power interruption during programming	Power turned OFF while program being edited.	●	Power turned OFF while program being edited.	Check that the voltage supplied to the Cam Positioner meets the specifications (85 to 264 V AC) and adjust if necessary.	Change to PRGM or SET mode and press the Clear Key to clear the error. Then re-input the cam program.
				RESET input turned ON while program being edited.	Adjust the RESET input sequence.	
				RESET input turned ON due to noise while program being edited.	Find the source of the noise and take appropriate countermeasures.	
					Check and adjust the wiring for control input signals.	
E-02	Power failure during write to non-volatile memory	Power turned OFF during data save to non-volatile memory.	●	Power turned OFF while writing to memory.	Check that the voltage supplied to the Cam Positioner meets the specifications (85 to 264 V AC) and adjust if necessary.	Change to PRGM or SET mode and press the Clear Key to clear the error. Then re-input the cam program.
				RESET input turned ON while writing to memory.	Adjust the RESET input sequence.	
				RESET input turned ON due to noise while writing to memory.	Find the source of the noise and take appropriate countermeasures.	
					Check and adjust the wiring for control input signals.	
E-10	Resolver disconnection error	Resolver cable disconnected during teaching or trial operation in RUN mode or error in Resolver interface circuit.	●	Resolver connector has been disconnected.	Check that the Resolver connector is connected securely.	Change to PRGM or SET mode and press the Clear Key to clear the error.
				Resolver connector connection imperfect.		
				Resolver cable disconnected.	Replace the Resolver cable.	
				Resolver detection circuit error.	Replace the Cam Positioner.	

Error code	Error name	Description	Cam output	Probable cause	Possible solution	Error reset method
E-11	Sum check error in program memory	Memory sum check error when power turned ON.	●	Malfunction due to noise (system recovers when power is turned ON again.)	Check if noise has been generated when or after the power was turned ON and take appropriate countermeasures against the noise.	Turn ON the power again.
				The Cam Positioner is malfunctioning (system does not recover when power is turned ON again.)	Replace the Cam Positioner.	---
E-12	System program sum check error	System program sum check error when power turned ON.	●	Malfunction due to noise (system recovers when power is turned ON again.)	Check if noise occurs when or after the power is turned ON and take appropriate countermeasures against the noise.	Turn ON the power again.
				The Cam Positioner is malfunctioning (system does not recover when power is turned ON again.)	Replace the Cam Positioner.	---
E-13	Memory error	Access to non-volatile memory not completed within set time.	○	Write to non-volatile memory not completed due to noise.	Find the source of the error and take appropriate countermeasures.	Change to PRGM or SET mode and press the Clear Key to clear the error.
				Read from non-volatile memory not completed due to noise.	Find the source of the error and take appropriate countermeasures.	
E-22	Cam data protect input prohibited	Attempt made to edit cam-protected cam data.	○	Attempt made to edit cam-protected cam data.	Once the error has been cleared, either remove the cam data protect, or edit different cam data that has not been cam data protected.	Press the Clear Key to clear the error.



Error code	Error name	Description	Cam output	Probable cause	Possible solution	Error reset method
E-23	Cam program duplication error	Attempt made to write program to the ON section of an existing program (including attempt with the teaching function)	○	Attempt made to write program to the ON section of an existing program (including attempt with the teaching function)	Once the error has been cleared, write the correct steps that are not duplicated.	Press the Clear Key to clear the error.
E-31	Communications error	No response from the Slave Unit; communications data error; different baud rate to Slave.	○	Different baud rate to Slave Unit.	Align the Master and Slave Unit baud rates (Function No. b, Parameter No. 6).	Press the Clear Key to clear the error.
				Slave Unit not operating.	Check the display on the Slave Unit (Bank/Function display: "t"; Cam/Parameter display: "0") and re-transmit the data from the Master Unit.	
				Slave Unit error.	Clear the errors on both the Master and Slave Units and re-transmit the data.	
				Slave Unit not in communications mode.	Check the display on the Slave Unit (Bank/Function display: "t"; Cam/Parameter display: "0") and re-transmit the data from the Master Unit.	
				Communications cable wired incorrectly.	Check and adjust the communications cable wiring.	
E-33	Verification error	Slave and Master data do not match.	○	Different programs or parameters are verified.	Check that the cam program and parameters are correct for each Cam Positioner.	Press the Clear Key to clear the error.
				Data corrupted due to noise during communications.	Find the source of the noise and take appropriate countermeasures.	

Error code	Error name	Description	Cam output	Probable cause	Possible solution	Error reset method
(Error indicator not lit)	Power OFF watchdog error	Power is not turned ON; RESET input has been turned ON; software error	●	Power has turned OFF.	Check that the voltage supplied to the Cam Positioner meets the specifications (85 to 264 V AC) and adjust if necessary.	Turn ON the power again.
				RESET input has been turned ON.	Adjust the RESET input sequence.	
				RESET input has been turned ON due to noise.	Find the source of the noise and take appropriate countermeasures. Check and adjust the wiring for control input signals.	
				The Cam Positioner is malfunctioning (system does not recover when power is turned ON again.)	Replace the Cam Positioner.	

## 5-2 CompoWay/F Communications Errors

If the 3F88L-160/162 Cam Positioner detects an error when data is being transferred using the CompoWay/F, it will return an end code other than “00” indicating a communications error. If an end code indicating a communications error has been returned, determine the cause and take the appropriate countermeasures.

Communications errors may be caused by incorrect wiring of the communications cable or noise during transmission. Therefore, always check the following points first.

- Check that communications cables are correctly wired.
- Check that communications cable connectors are securely connected.
- Check that there is no source of noise in the vicinity and that data has not been corrupted by noise during transmission.

### ■ Communications Errors

End code	Error name	Description	Probable cause	Probable solution
“0F”	FINS command error	The specified FINS-mini command cannot be executed.	A command not supported by the Cam Positioner has been issued.	Check the communications command.
			The Cam Positioner has an error.	Check the Cam Positioner.
			The Cam Positioner is in a different mode (not in a mode for which the issued command is enabled).	Check the Cam Positioner mode.
“10”	Parity error	A parity error has occurred for one of the characters during data reception.	The communications cable is wired incorrectly.	Check the cable wiring.
			Data has been corrupted due to noise during communications.	Check the cause of the noise.
“11”	Framing error	A framing error has occurred at the response frame.	The communications cable is wired incorrectly.	Check the cable wiring.
			Data has been corrupted due to noise during transmission.	Check the cause of the noise.
“12”	Overrun error	An overrun error has occurred.	The communications cable is wired incorrectly.	Check the cable wiring.
			Data has been corrupted due to noise during communications.	Check the cause of the noise.
“13”	BCC error	BCC for response frame is incorrect.	Data has been corrupted due to noise during communications.	Check the cause of the noise.
			The BCC operation is incorrect.	Check the communications protocol.

End code	Error name	Description	Probable cause	Probable solution
"14"	Format error	FINS frame is incorrect.	The communications cable is wired incorrectly.	Check the cable wiring.
			The frame has been corrupted due to noise during communications.	Check the cause of the noise.
			The incorrect frame has been transmitted.	Check the communications protocol.
"16"	Subaddress error	Subaddress for received frame is incorrect (not supported).	Data has been corrupted due to noise during communications.	Check the cause of the noise.
			The transmitted subaddress is not "00."	Check the communications protocol.
"18"	Frame length error	Received frame exceeds available (supported) number of bytes.	The received frame exceeds the number of supported bytes.	Check the communications protocol.

**5-3 Troubleshooting**

<b>Problem</b>	<b>Probable cause</b>	<b>Possible solution</b>
Nothing appears on the display. The ERROR terminal is H.	Power supply error.	Supply the correct power supply voltage.
	RESET signal has been input.	Check the connected wiring.
	Circuit error.	Replace the Cam Positioner.
	Watchdog timer error.	
Nothing appear on the display. The ERROR terminal is L.	Display circuit error.	Replace the Cam Positioner.
There are no cam outputs.	A cam program has not been input.	Check the cam program.
	Cam output power supply error.	Check the power supply voltage.
	BANK selection fault. START signal input fault.	Check the connected wiring.
	Control signal power supply fault. Circuit error.	Replace the Cam Positioner.
A specific cam output does not turn ON.	Wiring error.	Check the connected wiring.
	Externally-connected part error.	Replace the externally-connected part.
	Output transistor error.	Replace the Cam Positioner.
Unprogrammed outputs are being made.	A new cam program has been input without clearing the existing cam program.	Check the cam program.
	When copying a cam program from a 3F88L-160 Cam Positioner to a 3F88L-162 Cam Positioner, a cam program containing CAM17 to 32 has been input to the 3F88L-160 Cam Positioner (when a cam program has been copied to the 3F88L-160 from a 3F88L-162 beforehand.)	Check the cam program and delete any unnecessary cam programs.
	Program memory error.	Replace the Cam Positioner.

Problem	Probable cause	Possible solution
Cam outputs are strange.	A new cam program has been input without clearing the existing cam program.	Check the cam program.
	When using the advance angle compensation function, a cam program containing changing cam outputs has been input near the advance angle compensation position/the position where the advance angle will be compensated (during acceleration, cam outputs may be missed or output twice).	Set advance angle compensation value 3 (advance angle compensation position) to a section where the cam outputs do not change.  Do not use cam outputs during acceleration as operation signals.
	When using the copy function, data has been mistakenly copied from another Cam Positioner when reading data from that Cam Positioner.	Check the parameters and cam programs of the source Cam Positioner and then perform the copy operation.
	When using the copy function, data has been mistakenly written to another Cam Positioner when reading data from that Cam Positioner.	Set the parameters for the source Cam Positioner, and, once all cam programs have been re-input, perform the copy operation.
	Program memory error.	Replace the Cam Positioner.
Exiting of a cam program that shouldn't be there (CAM17 to 32).	When copying a cam program from a 3F88L-160 Cam Positioner to a 3F88L-162 Cam Positioner, a cam program containing CAM17 to 32 has been input to the 3F88L-160 Cam Positioner (when a cam program has been copied to the 3F88L-160 from a 3F88L-162 beforehand.)	Check the cam program and delete any unnecessary cam programs.
Origin compensation has been performed but the origin does not return to 0.	An origin compensation value has been set.	Check the origin compensation value.
	The Resolver is rotating.	Check the machinery operation.
	Circuit error.	Replace the Cam Positioner.
The origin position is displaced. The present angle is displaced.	A TRIG signal has been input.	Check the connection wiring.
	The coupling is displaced.	Check the Resolver coupling.
	The temperature variation is great.	Check the ambient temperature variation.
	The Resolver cable is corrupted and shorted with the frame ground (FG).	Check the Resolver cable.
	Circuit error.	Replace the Cam Positioner.
The operation keys do not work.	The functions are limited by the function level selection.	Check and, if necessary, adjust the function level selection (Function No. U) and turn OFF the power and then turn it ON again.
	Circuit error.	Replace the Cam Positioner.

Problem	Probable cause	Possible solution
<p>The cam output position is different to the one set using the teaching function.</p>	<p>Backlash compensation has been enabled after teaching has been performed.</p>	<p>With the backlash compensation already enabled, perform the teaching operation again.</p>
	<p>With backlash compensation enabled, the load side (driven side) instead of the Resolver axle (drive side) has been manually rotated and teaching performed. (Backlash compensation will work in reverse.)</p>	<p>Manually rotate the Resolver axle (drive side) and perform teaching again.</p>
	<p>Teaching has been performed while the Resolver is rotating (less than 4 r/min).</p>	<p>Perform teaching again with the Resolver stationary. Use the trial operation and adjustment operation functions to adjust the cam program (ON/OFF angle data).</p>
<p>When the speed increases, the timing of peripheral device operation is late.</p>	<p>The advance angle compensation function is not used.</p>	<p>Set the advance angle compensation function (Function No. b, Parameter No. 3 to 5 and Function No. H and Parameter No. 2) and turn OFF the power and turn it ON again.</p>
	<p>The advance angle compensation function is not enabled.</p>	<p>Enable the advance angle compensation function (Function No. H, Parameter No. 2) and turn OFF the power and turn it ON again.</p>

---

## 5-4 Inspection and Maintenance

---

### ■ Regular Inspections

There are no parts that need to be constantly maintained for the Cam Positioner equipment operation but the following items should be checked during regular inspections to maintain performance.

- Check that the connectors are firmly connected.
- Check that there is no excessive strain on or any damage to the cables.
- Check that the Resolver rotates smoothly. Check that the axle is not displaced.
- Check that there is no excessive force on the couplings. Check that they are securely fastened.
- Check that the screws for all the terminals on the Unit are securely fastened.

### ■ Replacement Couplings

If a Coupling has been lost, purchase the following replacement items.

Product name	Model
Coupling for 3F88L-RS17 Resolver	3F88L-RL10
Coupling for 3F88L-RS15 Resolver	3F88L-RL6



---

## 5-5 Cam Positioner Replacement

---

### ■ Procedure

Perform the following procedure when replacing the Cam Positioner Unit.

This procedure is applicable when the data (cam programs and parameters) in the original Cam Positioner is normal and the copy function is operating normally.

If the data has been corrupted or the copy function does not operate normally, use the operation keys on the new Cam Positioner to input the data and make the settings based on the original cam program data and parameter settings.

#### 1. Preparation

- a) Check that the original Cam Positioner data (cam programs and parameters) is correct. (Refer to *3-5-3 Cam Program Creating and Checking and 3-6 Applied Functions.*)
- b) Set the CW/CCW setting switch on the new Cam Positioner to the same position as on the original Cam Positioner. (Refer to *3-5-2 Initial Settings.*)
- c) Delete all cam data protects on the new Cam Positioner and then turn OFF the power supply and turn it ON again to enable this setting. (Refer to *3-6-7 Cam Protect.*)
- d) Use the copy function and copy the data (cam programs and parameters) from the original Cam Positioner to the new Cam Positioner. (Refer to *3-6-13 Copy Function.*)
- e) Check that the data (cam programs and parameters) on the new Cam Positioner is correct. (Refer to *3-5-3 Cam Program Creating and Checking and 3-6 Applied Functions.*)

#### 2. Replacement

Replace the Cam Positioner and check the wiring. (Refer to *Chapter 2 Design.*)

#### 3. Compensation

Move the machinery to the origin compensation value position and perform origin compensation. (Refer to *3-6-4 Origin Compensation and Origin Shift.*)

#### 4. Confirmation

Start operation using the new Cam Positioner.

Make adequate checks to ensure that the machinery is operating without any problem.

Adjust the cam programs if necessary. (Refer to *3-5-6 Start Operation, 3-5-7 I/O Monitor Function, and 3-5-8 Control I/O Signals.*)

**Note** If the machinery cannot be moved to the origin compensation position from when the original Cam Positioner was set up, perform origin compensation at a different position as outlined below. The settings can be changed to the same as the original Cam Positioner by re-writing the origin compensation value parameters.

- a) Write the origin compensation value for the original Cam Positioner (Function No. b, Parameter No. 1).
- b) After the Cam Positioner has been replaced, move the machinery to the position where origin compensation will be performed.
- c) Set the origin compensation value for that position and turn OFF the power supply and turn it ON again to enable this setting.

- d) Perform origin compensation.
- e) Change the origin compensation value to that of the original Cam Positioner.

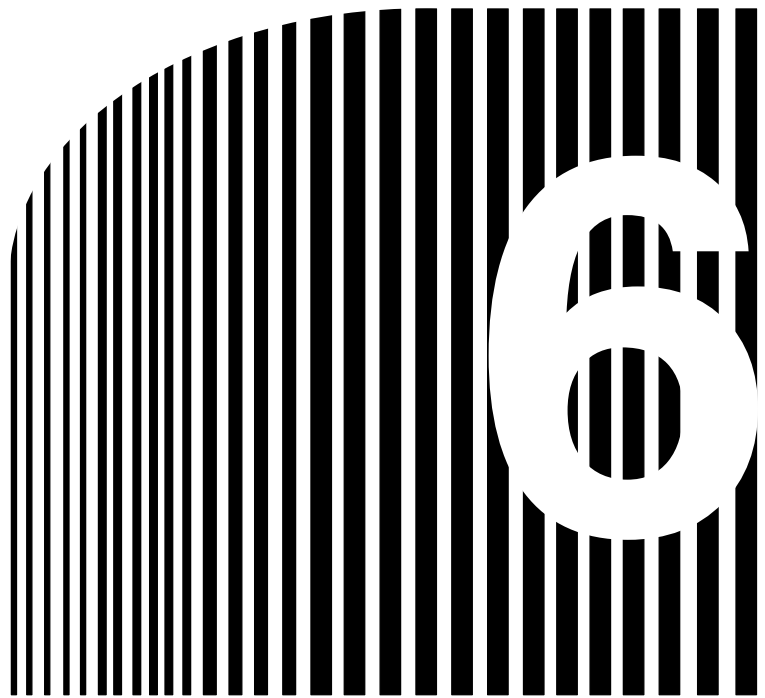

## Chapter 6

### • Specifications •

- 6-1 Cam Positioner Specifications
- 6-2 Resolver Specifications
- 6-3 I/O Block Specifications
- 6-4 Display Specifications

## 6-1 Cam Positioner Specifications

### ■ General Specifications

Model	3F88L-160	3F88L-162
Power supply voltage	100 to 240 V AC, 50/60 Hz	
Allowable power supply voltage	85 to 264 V AC	
Current consumption	18 VA max.	
Inrush current	40 A/10 ms max.	
I/O power supply	24 V DC/145 mA	
Allowable I/O power supply voltage	20.4 to 26.4 V DC	
Insulation resistance	20 M $\Omega$ min. between all AC power supply external terminals and the protective ground terminal (500 V) (see note)	
Dielectric strength	2,300 V AC, 50/60 Hz for 1 minute between all AC power supply external terminals and the protective ground terminal (leakage current of 10 mA max.) (see note)	
Noise immunity	1,500 Vp-p, pulse width of 0.1 to 1 $\mu$ s, 1-ns rising pulse (noise simulator)	
Vibration resistance	10 to 57 Hz, 0.075-mm single amplitude 57 to 150 Hz with an acceleration of 9.8 m/s <sup>2</sup> for 80 minutes each in X, Y, and Z directions (8 minutes x 10 times = 80 minutes)	
Shock resistance	147 m/s <sup>2</sup> , 3 times each in X, Y, and Z directions	
Ambient operating temperature	0 to 55°C	
Ambient operating humidity	10 to 90% (with no condensation)	
Ambient operating environment	No corrosive gases	
Ambient storage temperature	-20 to 75°C	
Terminal screws	Power supply input section: M3.5 screws Control I/O section: M3 screws	
Momentary power interruption detection time	Power interruptions of 15 ms or less are not detected.	
External dimensions	110 × 100 × 82.5 mm (W × H × D)	
Weight	1 kg max.	
Degree of protection	Panel-mounting	
Mounting method	M4 screws (2 points) or DIN track mounting	

**Note** Disconnect the functional ground terminal from the protective ground terminal when performing insulation resistance or withstand voltage tests

■ Performance Specifications

Model	3F88L-160	3F88L-162
Number of outputs	16	32
Output performance	Open collector output Maximum switching capacity: 300 mA at 26.4 V DC (1.6 A max. per connector)	
Number of banks	8 banks (at the resolution of 360), 4 banks (at the resolution of 720)	
Display	7-segment LED (execution bank, number of revolutions, and present cam angle)	
Response revolutions	1,600 r/min (at the resolution of 360), 800 r/min (at the resolution of 720)	
Detection cycle	100 μs max.	
Repeatability	0.2°	
Memory backup	Non-volatile memory (EEPROM), number of write operations: 100,000	
Control resolution	1/360 (at the resolution of 360), 1/720 (at the resolution of 720)	
Origin compensation	1 to 359 (at the resolution of 360), 1 to 719 (at the resolution of 720)	
Backlash compensation	1 to 179 (at the resolution of 360), 1 to 359 (at the resolution of 720)	
Advance angle compensation	Advance angle input range: 1 to 359 (at the resolution of 360), 1 to 719 (at the resolution of 720) Speed input range: 1 to 1,600 (at the resolution of 360), 1 to 800 (at the resolution of 720) <b>Note</b> When the speed input is set to 0, the advance angle input must be 0.	
Control input	START, TRIG, BANK1 to BANK3, RESET Photocoupler input with an input impedance of 4.7 kΩ	
Control output	RUN, ERROR, M-DET Open collector output, maximum switching capacity of 300 mA at 26.4 V DC	
Speed detection accuracy	5 r/min max.	

## 6-2 Resolver Specifications

### ■ Specifications

Type	Large diameter	High torque	Connector	Lead wire
Model	3F88L-RS17	3F88L-RS17T	3F88L-RS15	3F88L-RS15W
Axial diameter	10 dia.		6 dia.	
Axial load	Thrust: 196 N max. Radial: 196 N max.		Thrust: 98 N max. Radial: 98 N max.	
Total length	101 mm	110 mm	154 mm	97 mm
Mounting method	Flange-mounting (Flange strength: 245 N)		Servo-mount (mounting hooks included)	
Friction torque	12 mN • m max.	49 to 147 mN • m	2.9 mN • m max.	
Vibration resistance	Frequency range: 10 to 500 Hz Total amplitude: 1.5 mm or 98 m/s <sup>2</sup> , whichever is less Test time: 3 directions: X, Y, Z (2 hrs each)			
Shock resistance	4,900 m/s <sup>2</sup> in X, Y, and Z directions, 3 times each			
Degree of protection	Drip-proof, oil-proof, IP52F (JEM)			
Frequency	5 kHz			
Primary voltage	10 V			
Electrical malfunction	10 minutes			
Maximum speed	3,000 r/min (Mechanical)			
Coupling	3F88L-RL10		3F88L-RL6	
Wiring method	Cable (3 m, end connector included)		Connector	Lead wire (350 mm)
Applicable cable	3F88L-CR□□□C		3F88L-CR□□□NA	3F88L-CR□□□SA
Color	Munsell 5Y3/1		Munsell N1.5	
Ambient operating temperature	-10 to 80°C			

### ■ Connection between Resolver and Cam Positioner

#### ● Cam Positioner Connector

Use the Resolver Cable (sold separately) for connecting the Resolver to the Cam Positioner connector. Using the Cable will eliminate soldering effort and improve noise immunity.

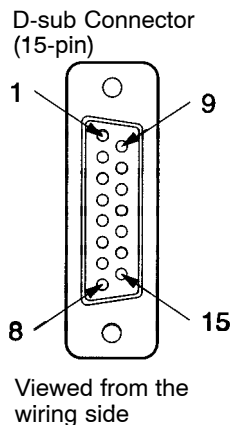

Pin No.	Signal name	Cable color on Resolver side
1	S1 (sin <sup>+</sup> )	Red
2	S3 (sin <sup>-</sup> )	Black
3	FG	
4	S2 (cos <sup>+</sup> )	Yellow
5	S4 (cos <sup>-</sup> )	Blue
6	FG	
7	---	
8	---	

Pin No.	Signal name	Cable color on Resolver side
9	Shield	
10	R1 (OUT <sup>+</sup> )	Red/White
11	R2 (OUT <sup>-</sup> )	Yellow/White
12	---	
13	---	
14	---	
15	---	

● 3F88L-RS15 Connector

RM15WTP-10S-(8)

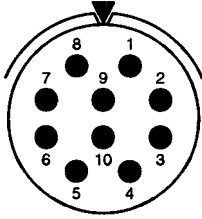

Pin No.	Signal name
1	S1 (sin <sup>+</sup> )
2	S3 (sin <sup>-</sup> )
3	---
4	R1 (OUT <sup>+</sup> )
5	R2 (OUT <sup>-</sup> )
6	---
7	S4 (cos <sup>-</sup> )
8	S2 (cos <sup>+</sup> )
9	---
10	---

● 3F88L-RS15W Resolver

Connect the lead wires to the 3F88L-CR□□□SA Resolver Cable.

Wire color	Signal name
Red	S1 (sin <sup>+</sup> )
Black	S3 (sin <sup>-</sup> )
Yellow	S2 (cos <sup>+</sup> )
Blue	S4 (cos <sup>-</sup> )
Red/White	R1 (OUT <sup>+</sup> )
Yellow/White	R2 (OUT <sup>-</sup> )

### 6-3 I/O Block Specifications

#### G7TC-OC16 I/O Block

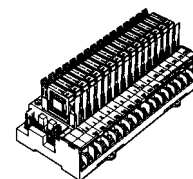

#### ■ Specifications

Item		Resistive load ( $\cos\phi=1$ )	Resistive load ( $\cos\phi=0.4$ , L/R=7 ms)
Rated load		5 A at 24 V DC, 2 A at 220 V AC	2 A at 24 V DC, 1 A at 220 V AC
Rated carry current		5 A	
Maximum contact voltage		250 V AC, 125 V DC	
Maximum contact current		5 A	2 A
Maximum switching capacity		120 W (DC), 440 V AC	48 W (DC), 220 V AC
Minimum applicable load (P-level reference value)		10 mA at 5 V DC	
Coil load current (per one relay)		Coil: 21 mA + LED: 4 mA	
Electrical life expectancy		1,000,000 times	
Mechanical life expectancy		50,000,000 times	
Contact form		SPST-NO $\times$ 16	
Contact resistance		50 m $\Omega$ max.	
Operating time		15 ms max.	
Release time		15 ms max.	
Maximum switching frequency	Mechanical	18,000 times/hour	
	Rated load	1,800 times/hour	
Insulation resistance		100 M $\Omega$ (at 500 V)	
Dielectric strength	Between coil and contact	2,000 V AC at 50/60 Hz for one minute	
	Between contacts of same polarity	1,000 V AC at 50/60 Hz for one minute	
	Between connectors	250 V AC at 50/60 Hz for one minute	
Malfunction vibration resistance		10 to 55 Hz, double amplitude of 1.0 mm	
Malfunction shock resistance		200 m/s <sup>2</sup>	
Noise immunity		Noise level: 1.5 kV, pulse width: 100 ns to 1 $\mu$ s	
Operating ambient temperature		0 to 55°C	
Operating ambient humidity		35 to 85%	
Tightening torque of external connections		0.78 to 11.8 N $\bullet$ m	
Coil surge absorption		Diode (1 A, 400 V)	
Weight		Approx. 670 g	



■ Internal Connection Diagram

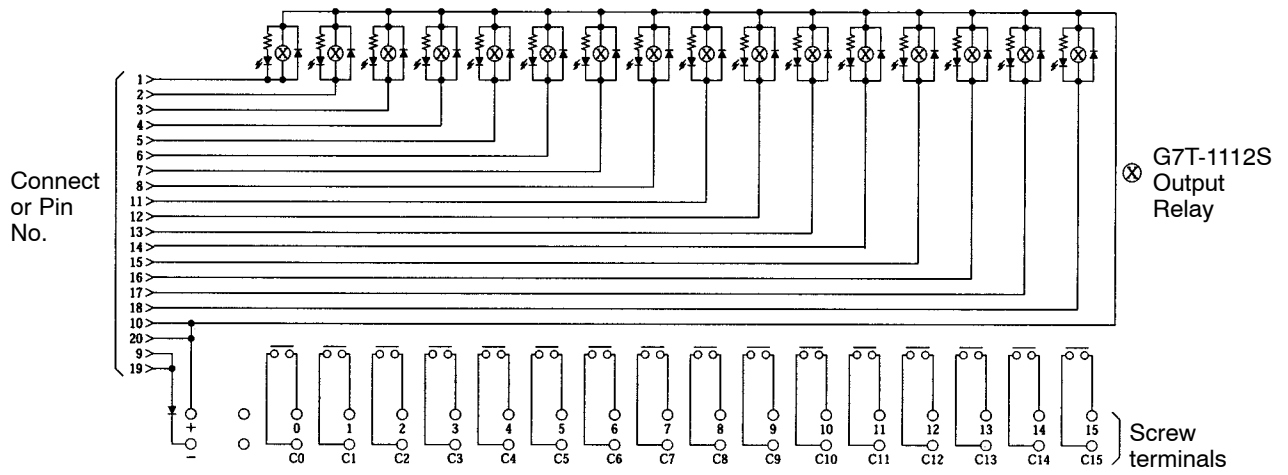

## 6-4 Display Specifications

### M7E Digital Display

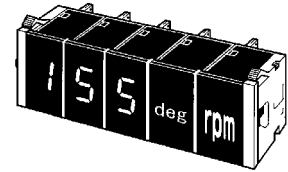

#### ■ Specifications

Item		Specifications
Rated voltage		Variable voltage between 12 and 24 V DC
Current consumption (per display)		Red LED: 35 mA max. (at 24 V DC) 45 mA max. (at 12 V DC) Green LED: 40 mA max. (at 24 V DC) 55 mA max. (at 12 V DC)
Input level	Positive logic	H: 4 V to power supply voltage L: 0 to 1.5 V
Operating ambient temperature		-10 to 55°C (with no icing)
Operating ambient humidity		35 to 85% (with no condensation)
Storage temperature		-25 to 70°C (with no icing)
Insulation resistance		100 MΩ min. (at 500 V DC) between each terminal and mounting panel
Dielectric strength		500 V AC, 50/60 Hz for 1 min between each terminal and mounting panel
Noise immunity		Power terminal: ±500 V Input terminals: ±500 V (normal mode) ±1,500 V (common mode)
Vibration resistance		10 to 55 Hz, 0.75-mm double amplitude
Shock resistance		300 m/s <sup>2</sup>
Degree of protection		IEC IP40 (portion on panel surface)
Compatible connector		OMRON NRT-C/NRT-CP
Display accuracy		5 r/min max.

■ Terminal Arrangement

● Decimal/Hexadecimal Display

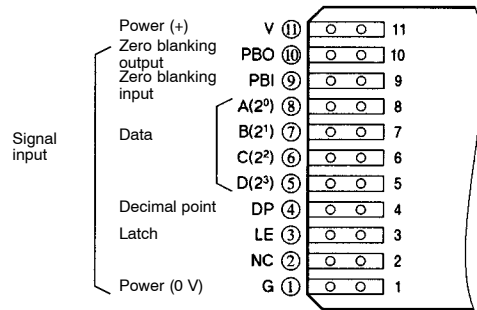

● Unit Display

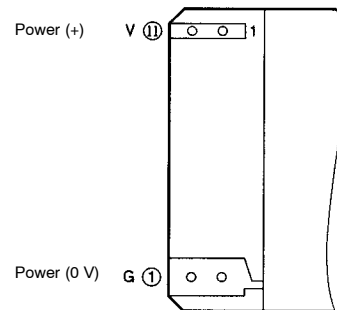

**Note** Values in circles apply to the NRT Connector's pin numbers.

Terminal symbol	Name	Function						
V	Power supply	Positive side (+) power-supply terminal.						
PBO	Zero blanking output	The output will be open if PBI is open and the display is "0." The output will be 0V if PBI is 0V or if the display is other than "0."						
PBI	Zero blanking input	"0" will not be displayed if DP is open and PBI is open. If connected to 0V, "0" will be displayed. If DP is set to 0V, the display will not be affected by the state of PBI.						
A B C D	Data input	<table border="0"> <tr> <td>A (2<sup>0</sup>)</td> <td rowspan="4">} Decimal/hexadecimal display</td> <td rowspan="4"> <ul style="list-style-type: none"> <li>• Displays a digit or symbol corresponding to the value of the binary code signal.</li> <li>• Decimal display uses 0 to 9; nothing will be displayed for higher values.</li> </ul> </td> </tr> <tr> <td>B (2<sup>1</sup>)</td> </tr> <tr> <td>C (2<sup>2</sup>)</td> </tr> <tr> <td>D (2<sup>3</sup>)</td> </tr> </table>	A (2 <sup>0</sup> )	} Decimal/hexadecimal display	<ul style="list-style-type: none"> <li>• Displays a digit or symbol corresponding to the value of the binary code signal.</li> <li>• Decimal display uses 0 to 9; nothing will be displayed for higher values.</li> </ul>	B (2 <sup>1</sup> )	C (2 <sup>2</sup> )	D (2 <sup>3</sup> )
A (2 <sup>0</sup> )	} Decimal/hexadecimal display	<ul style="list-style-type: none"> <li>• Displays a digit or symbol corresponding to the value of the binary code signal.</li> <li>• Decimal display uses 0 to 9; nothing will be displayed for higher values.</li> </ul>						
B (2 <sup>1</sup> )								
C (2 <sup>2</sup> )								
D (2 <sup>3</sup> )								
DP	Decimal point	The decimal point lights. Operates independently from the LE terminal.						
LE	Latch	When this signal is present, the immediately preceding display condition is retained.						
G	Power supply	0 V power-supply (ground) input terminal (GND).						

M7F Digital Display



■ Specifications

Item		Specifications
Rated voltage		Variable voltage between 12 and 24 V DC
Current consumption (per display)		14 mm: 200 mA max. (at 12 V DC) 100 mA max. (at 24 V DC) 25 mm: 300 mA max. (at 12 V DC) 200 mA max. (at 24 V DC)
Input level	Positive logic	H: 4 V to power supply voltage L: 0 to 1.5 V
Operating ambient temperature		-10 to 55°C (with no icing)
Operating ambient humidity		35 to 85% (with no condensation)
Storage temperature		-25 to 70°C (with no icing)
Insulation resistance		100 MΩ min. (at 500 V DC) between each terminal and mounting panel
Dielectric strength		1,000 V AC, 50/60 Hz for 1 min between each terminal and mounting panel
Noise immunity		Power terminal: ±500 V (normal mode) Input terminals: ±1,500 V (common mode) I/O cable: ±800 V (when the specified cable is used)
Vibration resistance		10 to 55 Hz, 1.5-mm double amplitude
Shock resistance		300 m/s <sup>2</sup>
Degree of protection		IEC IP40
Compatible connector		OMRON XG5M-2035-N/XG5S-1001 or 2012
Display accuracy		5 r/min max.

■ Terminal Arrangement

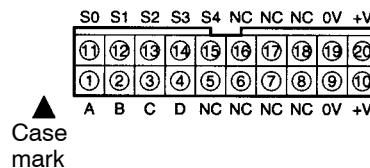

Terminal symbol	Name	Function
A B C D	Data input	A (2 <sup>0</sup> ) B (2 <sup>1</sup> ) C (2 <sup>2</sup> ) D (2 <sup>3</sup> ) } The numeral or symbol corresponding to the binary code signal will be displayed.
S0 S1 S2 S3 S4	Control input	S0 (10 <sup>0</sup> ) S1 (10 <sup>1</sup> ) S2 (10 <sup>2</sup> ) S3 (10 <sup>3</sup> ) S4 (10 <sup>4</sup> ) } Designates the digit to be displayed. Each digit will maintain the previous value when this signal is input.
+V	Power supply	Power supply and output terminal
0V	Power supply	Power supply 0-V output terminal (GND)

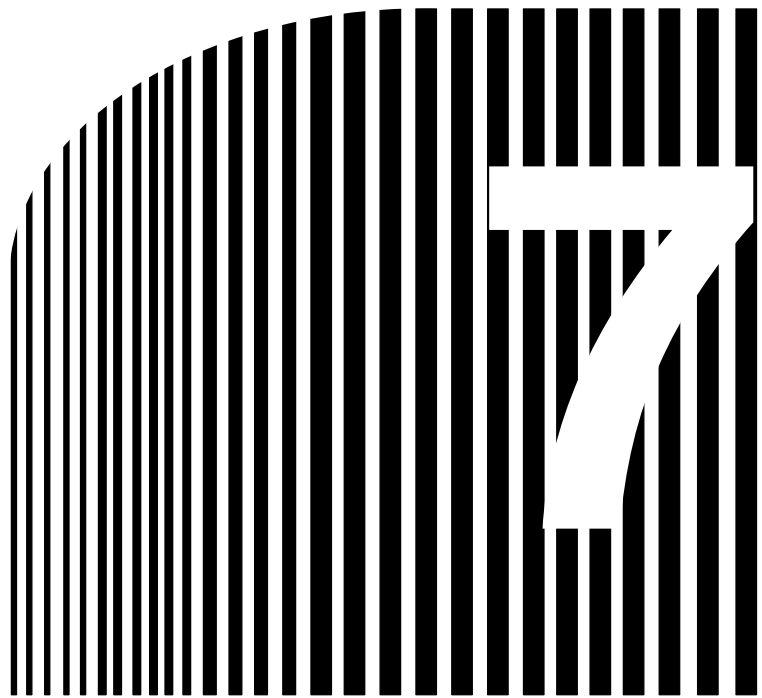

## Chapter 7

### • Appendix •

- 7-1 Application Examples
- 7-2 Performance
- 7-3 Resolver Life Expectancy
- 7-4 Standard Models
- 7-5 Displays by Mode
- 7-6 Error Codes
- 7-7 Cam Programming Sheet
- 7-8 Parameter Settings Log Chart

## 7-1 Application Examples

### ■ Reading Present Value Output Signals with an OMRON PC

#### ● System Configuration

- Cam Positioner: 3F88L-160 (16-point type)
- Present angle value output setting (Function No. H, Parameter No. 4): “1” (4-digit present angle, no units)
- CIO bits: a, b, c, d, e
- Data memory used to store present value data: D01000 (work), D01001 (present value data storage)
- Wire cam outputs 1 to 16 to IN0 to IN15 on the Input Unit allocated to word 0 in the PC.

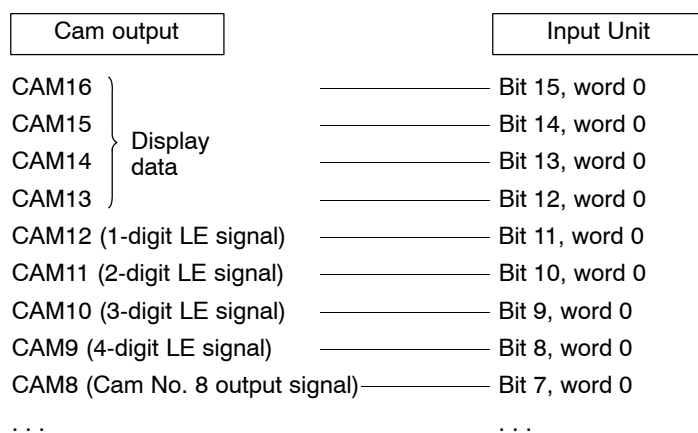

#### ● Points to Consider

The 3F88L-160/162 Cam Positioner present value outputs have been adjusted to suit the M7E Display Unit. The displayed data is, therefore, the reverse of the normal signal.

Item	M7E display										For PRGM/SET mode	If errors occur	
	0	1	2	3	4	5	6	7	8	9			
Display data (signal status)	CAM16	1	1	1	1	1	1	1	1	0	0	0	0
	CAM15	1	1	1	1	0	0	0	0	1	1	1	0
	CAM14	1	1	0	0	1	1	0	0	1	1	0	0
	CAM13	1	0	1	0	1	0	1	0	1	0	1	1

**Note 1.** On this table, “0” indicates OFF and “1” indicates ON.

**Note 2.** The data on this table is for 3F88L-160 Cam Positioners. For 3F88L-162 Cam Positioners, CAM16 to 13 will be CAM32 to 29. (Refer to 3-6-10 Present Value Output Function.)

**Note 3.** In PRGM/SET mode, a code that gives “A” will be output when the bit is reversed (all digits). The following cases, however, are exceptions to this rule.

During trial operation or teaching: The display data will be output according to the present value output settings.

During origin compensation: Display data is output with the origin compensation absolute angle flashing.

(For approximately one second, “the code (all digits) that will give “E” when origin compensation absolute angle changed to bit reversal” will be repeatedly output.

**Note 4.** When an error occurs, a code that gives “E” will be output when the bit is reversed.

**Note 5.** For M7E Display Units, codes that give “A” to “F” when bits are reversed will not be displayed. For M7F Display Units, however, “A” to “F” will be displayed.

• Ladder Program

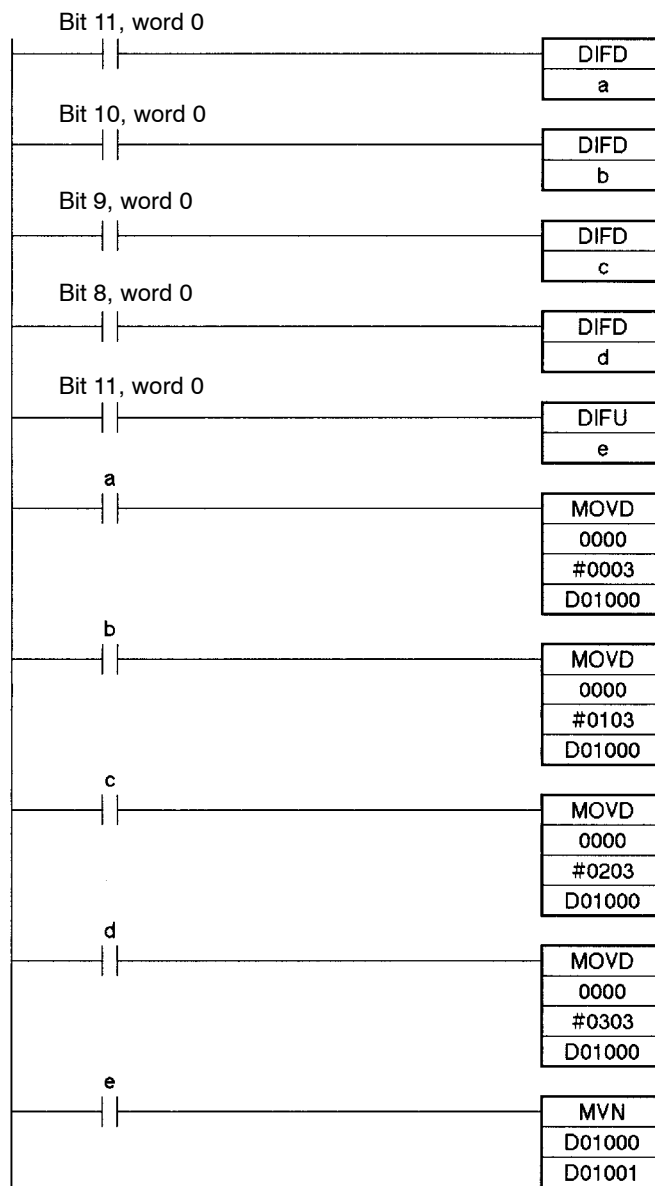

## 7-2 Performance

This section shows the performance values of the Cam Positioner.

**Note** This performance data is for reference only and cannot be guaranteed.

### ■ Initial Processing Time

The diagram shows the times from when the START input is turned ON and the power supply to the Cam Positioner is turned ON until cam outputs, RUN outputs, and ERROR outputs are made.

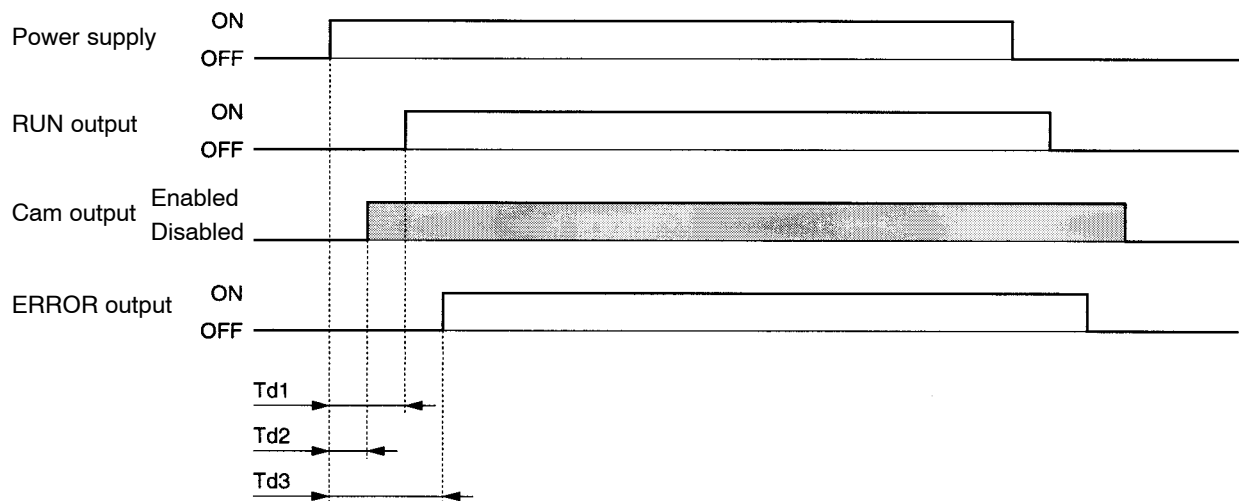

Data	Symbol	Standard time
RUN output delay time	Td1	2 s max.
Cam output delay time	Td2	2 s max.
ERROR output delay time	Td3	2 s max.



**Time from START Input to Start of Operation**

The diagram shows the time from when the START input is turned ON until cam outputs can be controlled.

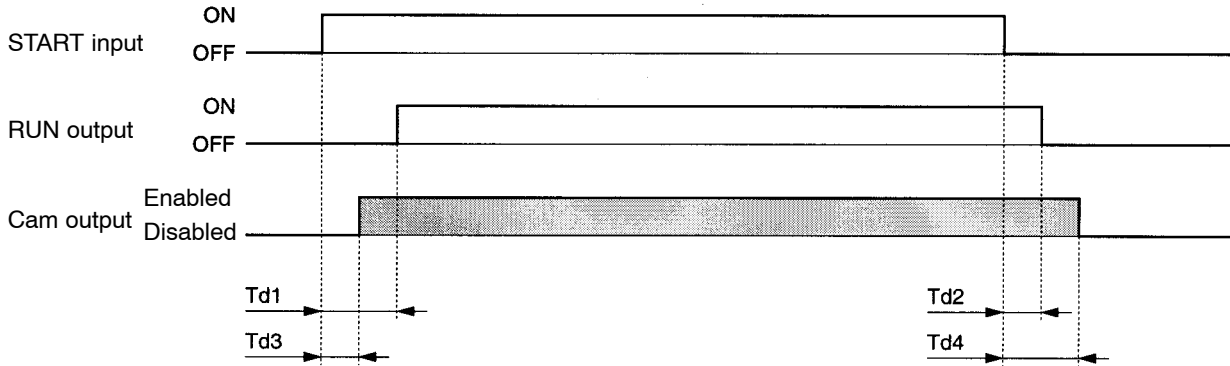

Data	Symbol	Standard time
RUN output delay time	Td1	10 ms max.
	Td2	8 ms max.
Cam output delay time	Td3	10 ms max.
	Td4	8 ms max.

**Origin Shift Processing Time**

The diagram shows the time from when TRIG input is turned ON until cam outputs and RUN outputs change.

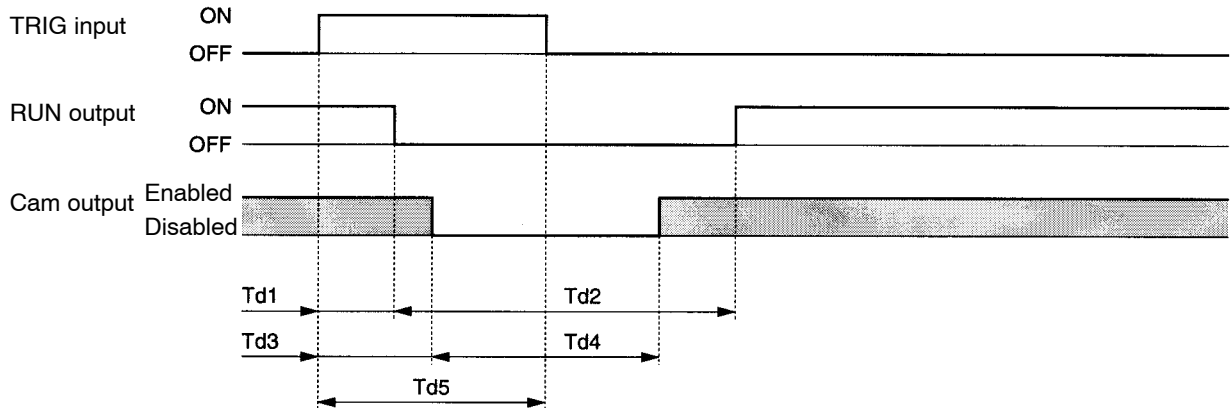

Data	Symbol	Standard time
RUN output delay time	Td1	15 ms max.
RUN output OFF time	Td2	0.8 to 1.2 s
Cam output delay time	Td3	15 ms max.
Cam output OFF time	Td4	0.8 to 1.2 s
Min. TRIG input enabled time	Td5	10 ms min.

### ■ M-DET ON/OFF Time

The diagram shows the time from when the Resolver speed is greater or less than 4 r/min until the M-DET output changes.

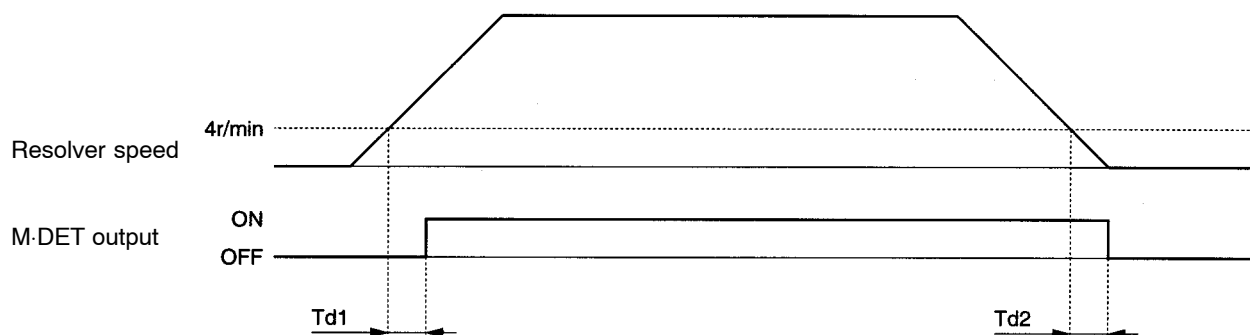

Data	Symbol	Standard time
M-DET output ON delay time	Td1	100 ms max.
M-DET output OFF delay time	Td2	200 ms max.

### ■ Bank Switching Time

The diagram shows the time taken to switch bank numbers during operation.

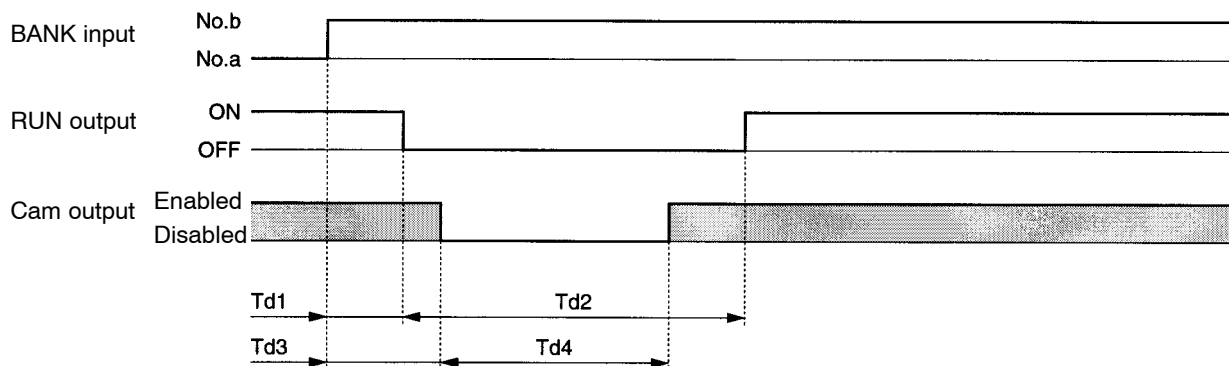

Data	Symbol	Standard time
RUN output delay time	Td1	10 ms max.
RUN output OFF time	Td2	0.8 to 1.2 s
Cam output delay time	Td3	10 ms max.
Cam output OFF time	Td4	0.8 to 1.2 s

### Cam Output Delay Time

The diagram shows the time taken while the Resolver is rotating from when the machinery arrives at the position where the cam output turns ON (ON angle in the cam program) until the cam output is actually turned ON.

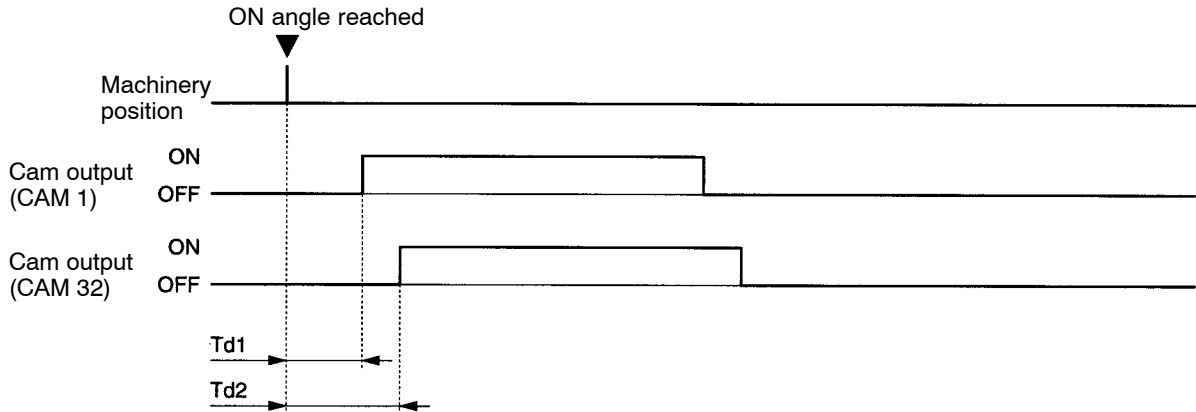

Data	Symbol	Standard time
Cam 1 output delay time	$T_{d1}$	0.35 ms max.
Cam 32 output delay time	$T_{d2}$	0.35 ms max.

**Note** The times shown include all the following times.

- Time taken by the Cam Positioner to detect the Resolver angle.
- Time taken to perform various compensation processing.
- Time taken to change cam outputs according to the cam program.

### Differences between Cams

This diagram shows the differences between different cam outputs when the same cam program is set for a different cam.

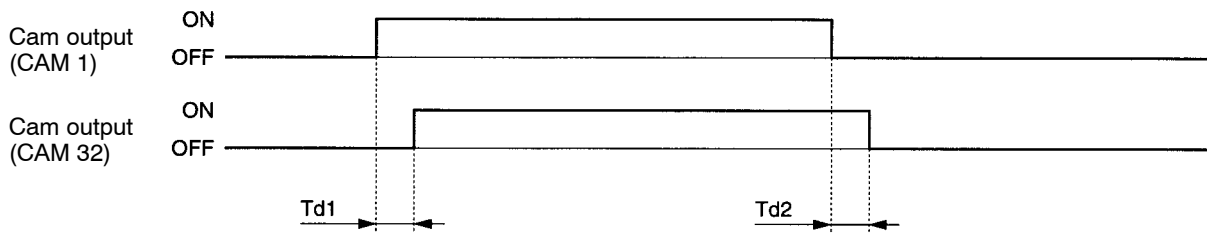

Data	Symbol	Standard time
ON time difference	$T_{d1}$	-10 to 10 $\mu$ s
OFF time difference	$T_{d2}$	-10 to 10 $\mu$ s

### 7-3 Resolver Life Expectancy

This section shows the life expectancy of the Resolver and couplings.

**Note** This performance data is for reference only and cannot be guaranteed.

#### ■ Resolvers

The life of the Resolver is determined by the life of the Resolver axle bearings.

##### ● 3F88L-RS17/RS17T Resolvers (Axle End Load: Radial and Thrust both 19.6 N)

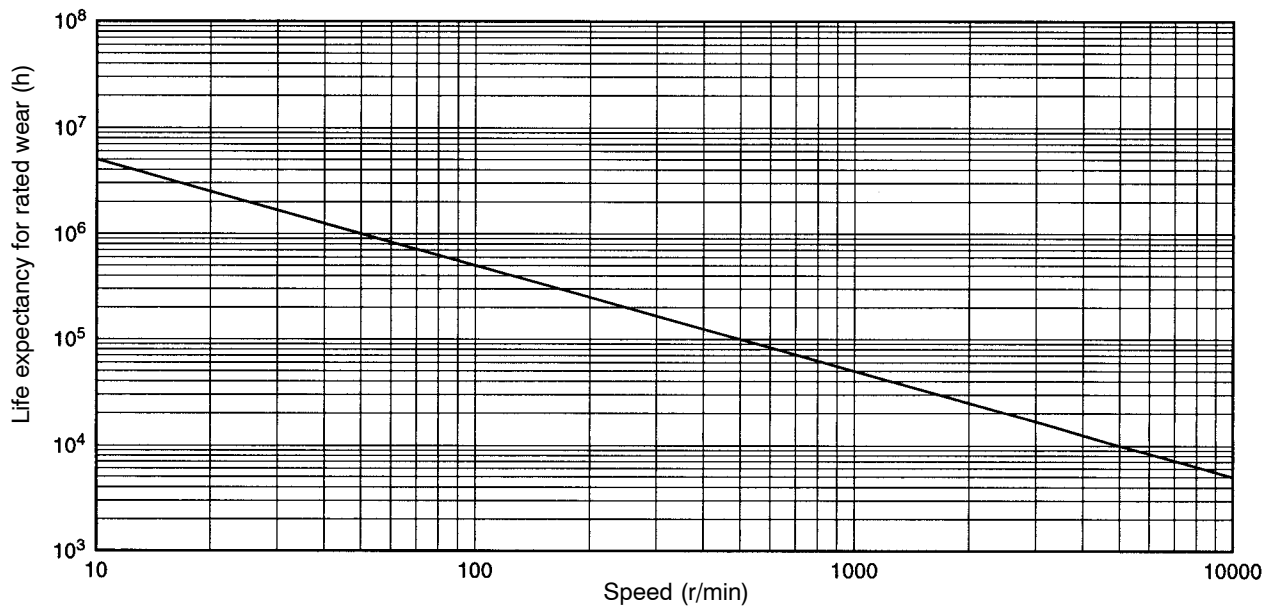

##### ● 3F88L-RS15/RS15W Resolvers (Axle End Load: Radial and Thrust both 19.6 N)

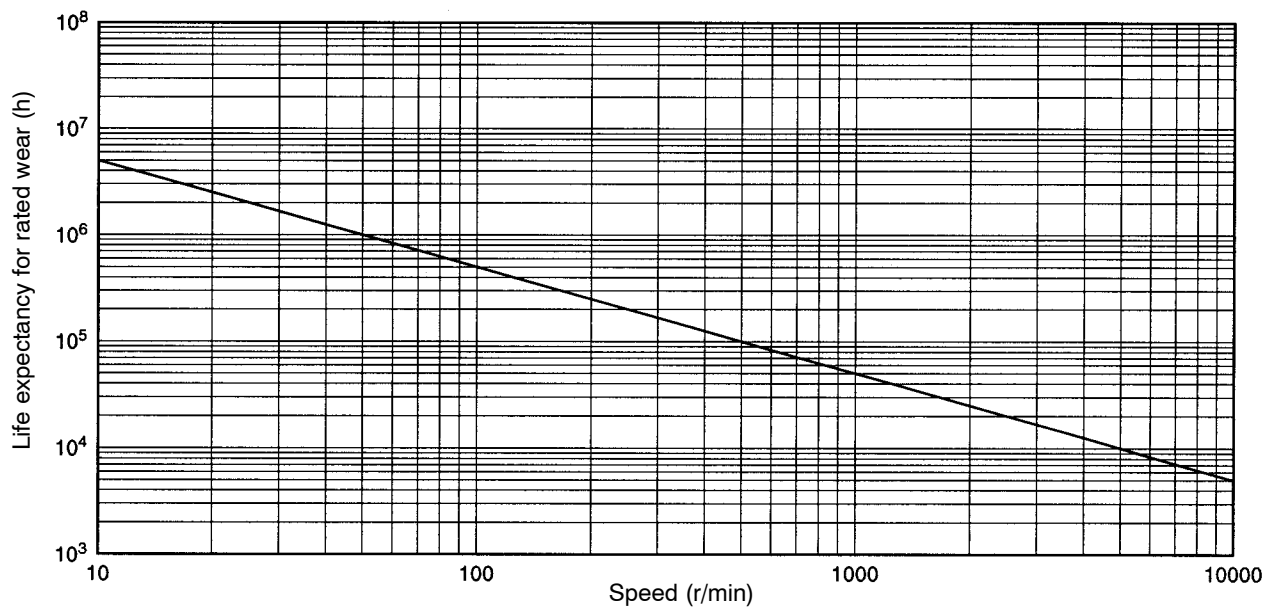

■ Couplings

The life expectancy of couplings is determined by tightening torque, bend angle, and axle core displacement volume.

● Tightening Torque and Rotation Life

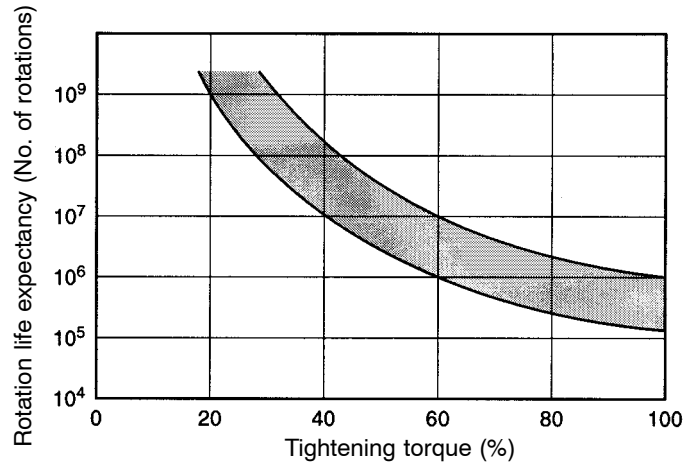

**Note** Tightening torque is given as a percentage of allowable tightening torque. (Refer to 2-2-3 Mounting the Resolver.)

● Bend Angle and Rotation Life

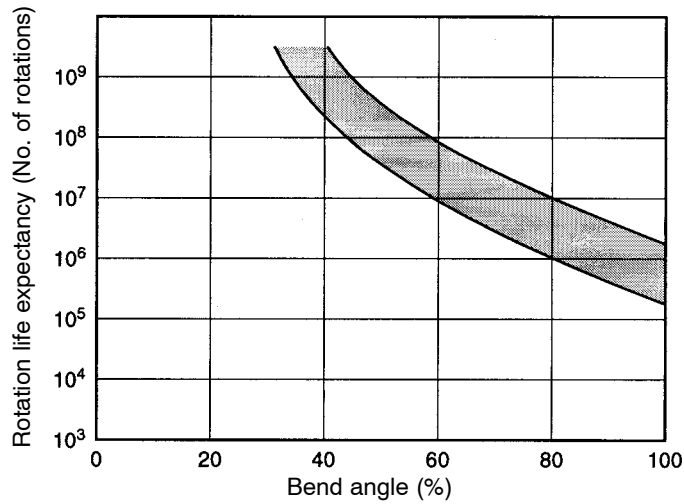

**Note** Bend angles are given as a percentage of allowable bend angles. (Refer to 2-2-3 Mounting the Resolver.)

- Axle Core Displacement and Rotation Life

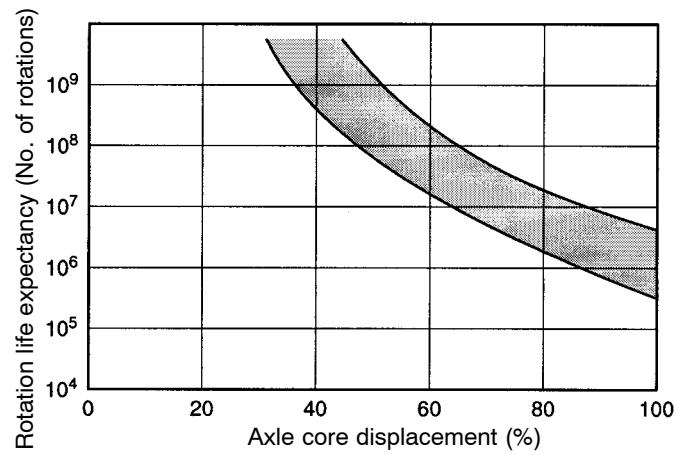

**Note** Axle core displacement is given as a percentage of allowable axle core displacement. (Refer to *2-2-3 Mounting the Resolver.*)

## 7-4 Standard Models

Product name	Specifications		Model
Cam Positioner	16-point type		3F88L-160
	32-point type		3F88L-162
Resolver	Large-diameter type		3F88L-RS17
	High-torque type		3F88L-RS17T
	Connector type		3F88L-RS15
	Lead type		3F88L-RS15W
I/O Block	16-point relay unit		G7TC-OC16
Display Unit	Numeric display		M7E-01DRD2 (red, decimal)
			M7E-01DGD2 (green, decimal)
	Units display		M7E-01UR2-V (red, r/min)
			M7E-01UG2-V (green, r/min)
			M7E-01UR2-A (red, no display)
			M7E-01UG2-A (green, no display)
	4-digit numeral display, character height of 14 mm		M7F-4D1R (red)
			M7F-4D1G (green)
	4-digit numeral display + units, character height of 14 mm		M7F-4D1RT (red)
			M7F-4D1GT (green)
	Units nameplate, character height of 14 mm		M7F-1 (not displayed)
			M7F-RPM-1 (r/min)
	4-digit numeral display, character height of 25 mm		M7F-4D2R (red)
			M7F-4D2G (green)
4-digit numeral display + units, character height of 25 mm		M7F-4D2RT (red)	
		M7F-4D2GT (green)	
Unit nameplate, character height of 25 mm		M7F-2 (not displayed)	
		M7F-RPM-2 (r/min)	
Resolver Extension Cable (for 3F88L-RS17/17T Resolvers)	With connectors at both ends	2 m	3F88L-CR002C
		5 m	3F88L-CR005C
		10 m	3F88L-CR010C
		20 m	3F88L-CR020C
		50 m	3F88L-CR050C
Resolver Cable (for 3F88L-RS15 Resolvers)	With connectors at both ends	3 m	3F88L-CR003NA
		5 m	3F88L-CR005NA
		10 m	3F88L-CR010NA
		15 m	3F88L-CR015NA
		20 m	3F88L-CR020NA
Resolver Cable (for 3F88L-RS15W Resolvers)	With connector at one end	3 m	3F88L-CR003SA
		5 m	3F88L-CR005SA
		10 m	3F88L-CR010SA
Cam Output Cable (for connection to I/O Block)	With connectors at both ends	0.5 m	3F88L-CG0R5N
		1 m	3F88L-CG001N
Cam Output Cable (for connection to other devices and Display Units)	With connector at one end	1 m	3F88L-CG001S
		3 m	3F88L-CG003S

## 7-5 Displays by Mode

### • SET Mode

Bank/Function	Cam/Parameter	Function	Data range	SPEED/ON	POSITION/OFF
1 to 8 (1 to 4) (see note 2)	0	Origin compensation absolute angle	---	Displays the absolute angle for origin compensation.	---
	1 to 32 (1 to 16) (see note 1)	Program number checking	---	Displays the number of steps for the displayed bank or cam number.	---
A (a)	1	Resolution selection	0, 1	0: 360 divisions/revolution (factory setting) 1: 720 divisions/revolution	---
b (b)	1	Origin compensation value	0 to 359 (0 to 719) (see note 2)	Sets origin compensation value (angle data). Factory setting "0."	---
	2	Backlash compensation value	0 to 179 (0 to 359) (see note 2)	Sets backlash compensation value (angle data). Factory setting "0."	---
	3	Advance angle compensation value 1	0 to 1600 (0 to 800) (see note 2)	Sets speed data for advance angle compensation value 1. Factory setting "0."	---
			0 to 359 (0 to 719) (see note 2)	---	Sets angle data for advance angle compensation value 1. Factory setting "0."
	4	Advance angle compensation value 2	0 to 1600 (0 to 800) (see note 2)	Sets speed data for advance angle compensation value 2. Factory setting "0."	---
			0 to 359 (0 to 719) (see note 2)	---	Sets angle data for advance angle value 2. Factory setting "0."
	5	Advance angle compensation value 3	0 to 359 (0 to 719) (see note 2)	---	Sets angle data for advance angle compensation value 3 (advance angle compensated position). Factory setting "0."
	6	Baud rate	1, 2	1: 9,600 bps (factory setting) 2: 19,200 bps	---



Bank/Function	Cam/Parameter	Function	Data range	SPEED/ON	POSITION/OFF
c (c)	---	Cam protect	---	Protection can be set or released for each cam number or for all cams in a bank number. (Factory setting: "unprotected")	Protect can be set or released for each cam number or for all cams in a bank number (Factory setting "unprotected")
d (d)	---	Teaching	---	Present Resolver angle can be input as ON angle data.	Present Resolver angle can be input as OFF angle data.
F (f)	---	One-direction function setting	0 to 2	---	0: One-direction function disabled (factory setting) 1: Enabled in forward direction 2: Enabled in reverse direction
H (h)	1	Backlash compensation enable/disable setting	0, 1	0: Backlash compensation disabled (factory setting) 1: Backlash compensation enabled	---
	2	Advance angle compensation enable/disable setting	0, 1	0: Advance angle compensation disabled (factory setting) 1: Advance angle compensation enabled	---
	3	Output hold	0, 1	0: Output hold disabled (factory setting) 1: Output hold enabled	---

Bank/Function	Cam/Parameter	Function	Data range	SPEED/ON	POSITION/OFF
H (h)	4	Present value output setting	0 to 4	0: No present value output function (factory setting) 1: 4-digit present angle (no units) 2: 4-digit number of rotations (no units) 3: Automatic switching of 3-digit present angle and number of rotations (with units) 4: Automatic switching of 4-digit present angle and number of rotations (with units)	---
P (p) (see note 4)	---	Pulse output setting	---	Writes pulse output program to any bank or cam number (sets pulse number).	(Sets pulse start position.)
t (t) (see note 4)	0	Data transfer (Slave setting)	---	(Operates on a command issued from Master Unit.)	---
	1	Data transfer (Master setting)	0 to 3	0: Disabled (factory setting) 1: Read data 2: Write data 3: Verify data	---
U (u)	1	Function level selection	0 to 2	0: Function level 0 (monitor only) 1: Function level 1 (basic operation/monitor only) (factory setting) 2: Function level 2 (all functions)	---
---	---	Error display	---	E-** (error display)	---

**Note 1.** The data for the 3F88L-160 (16-point model) Cam Positioner is shown in parentheses.

**Note 2.** The data for 720 resolution (divisions/revolution) is shown in parentheses. The angles will be set and displayed as "1" for 0.5°.

**Note 3.** Functions A, b, C, F, H, and U will be enabled after the power has been turned OFF and then ON again.

**Note 4.** Functions P and t are special operations that are not stored as parameters.

### ● RUN Mode

Bank/Function	Cam/Parameter	Start input	SPEED/ON	POSITION/OFF
1 to 8 (1 to 4) (see note 2)	---	OFF	Number of Resolver rotations (r/min)	Present angle
	ru (rU)	ON		
1 to 8 (1 to 4) (see note 2)	1 to 32 (1 to 16) (see note 1)	ON	Compensation operation ON angle	Compensation operation OFF angle
o (o)	1	---	Cam output monitor	
	2	---	Control I/O monitor	
---	---	---	E-** (error display)	---

**Note 1.** The data for the 3F88L-160 (16-point model) Cam Positioner is shown in parentheses.

**Note 2.** The data for 720 resolution (divisions/revolution) is shown in parentheses. The angles will be set and displayed as “1” for 0.5°.

### ● PRGM Mode

Bank/Function	Cam/Parameter	SPEED/ON	POSITION/OFF
1 to 8 (1 to 4) (see note 2)	1 to 32 (1 to 16) (see note 1)	ON angle	OFF angle
1 to 8 (1 to 4) (see note 2)	1 to 32 (1 to 16) (see note 1)	“t (t)” + ON angle (trial operation)	OFF angle (trial operation)
---	---	E-** (error display)	---

**Note 1.** The data for the 3F88L-160 (16-point model) Cam Positioner is shown in parentheses.

**Note 2.** The data for 720 resolution (divisions/revolution) is shown in parentheses. The angles will be set and displayed as “1” for 0.5°.

## 7-6 Error Codes

**Note** The “●” mark in the cam output column indicates that cam outputs are turned OFF regardless of the output hold settings. The “○” mark indicates that if output hold is set, the output status immediately before the error was generated will be maintained. If output hold is not set, cam outputs will be turned OFF. (Refer to 3-6-9 *Output Hold Function* for information.)

Error code	Error name	Description	Cam output	Probable cause	Possible solution	Error reset method
E-00	Hardware failure	Memory read/write check error when power turned ON.	●	Malfunction due to noise (system recovers when power is turned ON again.)	Check if noise has been generated when or after the power was turned ON and take appropriate countermeasures against the noise.	Turn the power ON again.
				The Cam Positioner is malfunctioning (system does not recover when power is turned ON again.)	Replace the Cam Positioner.	---
E-01	Power interruption during programming	Power turned OFF while program being edited.	●	Power turned OFF while program being edited.	Check that the voltage supplied to the Cam Positioner meets the specifications (85 to 264 V AC) and adjust if necessary.	Change to PRGM or SET mode and press the Clear Key to clear the error. Then re-input the cam program.
				RESET input turned ON while program being edited.	Adjust the RESET input sequence.	
				RESET input turned ON due to noise while program being edited.	Find the source of the noise and take appropriate countermeasures. Check and adjust the wiring for control input signals.	

Error code	Error name	Description	Cam output	Probable cause	Possible solution	Error reset method
E-02	Power failure during write to non-volatile memory	Power turned OFF during data save to non-volatile memory.	●	Power turned OFF while writing to memory.	Check that the voltage supplied to the Cam Positioner meets the specifications (85 to 264 V AC) and adjust if necessary.	Change to PRGM or SET mode and press the Clear Key to clear the error. Then re-input the cam program.
				RESET input turned ON while writing to memory.	Adjust the RESET input sequence.	
				RESET input turned ON due to noise while writing to memory.	Find the source of the noise and take appropriate countermeasures. Check and adjust the wiring for control input signals.	
E-10	Resolver disconnection error	Resolver cable disconnected during teaching or trial operation in RUN mode or error in Resolver interface circuit.	●	Resolver connector has been disconnected.	Check that the Resolver connector is connected securely.	Change to PRGM or SET mode and press the Clear Key to clear the error.
				Resolver connector connection imperfect.		
				Resolver cable disconnected.	Replace the Resolver cable.	
				Resolver detection circuit error.	Replace the Cam Positioner.	
E-11	Sum check error in program memory	Memory sum check error when power turned ON.	●	Malfunction due to noise (system recovers when power is turned ON again.)	Check if noise has been generated when or after the power was turned ON and take appropriate countermeasures against the noise.	Turn ON the power again.
				The Cam Positioner is malfunctioning (system does not recover when power is turned ON again.)	Replace the Cam Positioner.	---

Error code	Error name	Description	Cam output	Probable cause	Possible solution	Error reset method
E-12	System program sum check error	System program sum check error when power turned ON.	●	Malfunction due to noise (system recovers when power is turned ON again.)	Check if noise occurs when or after the power is turned ON and take appropriate countermeasures against the noise.	Turn ON the power again.
				The Cam Positioner is malfunctioning (system does not recover when power is turned ON again.)	Replace the Cam Positioner.	---
E-13	Memory error	Access to non-volatile memory not completed within set time.	○	Write to non-volatile memory not completed due to noise.	Find the source of the error and take appropriate countermeasures.	Change to PRGM or SET mode and press the Clear Key to clear the error.
				Read from non-volatile memory not completed due to noise.	Find the source of the error and take appropriate countermeasures.	
E-22	Cam data protect input prohibited	Attempt made to edit cam-protected cam data.	○	Attempt made to edit cam-protected cam data.	Once the error has been cleared, either remove the cam data protect, or edit different cam data that has not been cam data protected.	Press the Clear Key to clear the error.
E-23	Cam program duplication error	Attempt made to write program to the ON section of an existing program (including attempt with the teaching function)	○	Attempt made to write program to the ON section of an existing program (including attempt with the teaching function)	Once the error has been cleared, write the correct steps that are not duplicated.	Press the Clear Key to clear the error.

Error code	Error name	Description	Cam output	Probable cause	Possible solution	Error reset method
E-31	Communications error	No response from the Slave Unit; communications data error; different baud rate to Slave.	○	Different baud rate to Slave Unit.	Align the Master and Slave Unit baud rates (Function No. b, Parameter No. 6).	Press the Clear Key to clear the error.
				Slave Unit not operating.	Check the display on the Slave Unit (Bank/Function display: "t"; Cam/Parameter display: "0") and re-transmit the data from the Master Unit.	
				Slave Unit error.	Clear the errors on both the Master and Slave Units and re-transmit the data.	
				Slave Unit not in communications mode.	Check the display on the Slave Unit (Bank/Function display: "t"; Cam/Parameter display: "0") and re-transmit the data from the Master Unit.	
				Communications cable wired incorrectly.	Check and adjust the communications cable wiring.	
E-33	Verification error	Slave and Master data do not match.	○	Different programs or parameters are verified.	Check that the cam program and parameters are correct for each Cam Positioner.	Press the Clear Key to clear the error.
				Data corrupted due to noise during communications.	Find the source of the noise and take appropriate countermeasures.	

Error code	Error name	Description	Cam output	Probable cause	Possible solution	Error reset method
(Error indicator not lit)	Power OFF watchdog error	Power is not turned ON; RESET input has been turned ON; software error	●	Power has turned OFF.	Check that the voltage supplied to the Cam Positioner meets the specifications (85 to 264 V AC) and adjust if necessary.	Turn ON the power again.
				RESET input has been turned ON.	Adjust the RESET input sequence.	
				RESET input has been turned ON due to noise.	Find the source of the noise and take appropriate countermeasures. Check and adjust the wiring for control input signals.	
				The Cam Positioner is malfunctioning (system does not recover when power is turned ON again.)	Replace the Cam Positioner.	





## 7-8 Parameter Settings Log Chart

### ● Unit Model

Cam Positioner	<input type="checkbox"/> 3F88L-160 (16-point model)	<input type="checkbox"/> 3F88L-162 (32-point model)	Remarks:
----------------	--	--	----------

### ● Switch Setting

CW/CCW setting switch	<input type="checkbox"/> CW	<input type="checkbox"/> CCW
-----------------------	-----------------------------	------------------------------

### ● Parameter Settings

FUN No.	PRMTR No.	Function	Function level for settings	Setting range	Settings	Settings
U (u)	1	Function level selection	<input type="checkbox"/> 0 <input type="checkbox"/> 1 <input type="checkbox"/> 2	0 to 2	0: Function level 0 (monitor only) 1: Function level 1 (basic operation/monitor only) 2: Function level 2 (all functions)	Settings when parameter setting is made.
						Settings when machine is operating.
A (a)	1	Resolution selection	<input type="checkbox"/> 1 <input type="checkbox"/> 2	0, 1	0: 360 divisions/ revolution (factory setting) 1: 720 divisions/ revolution	
b (b)	1	Origin compensation value	<input type="checkbox"/> 2	0 to 359 (0 to 719) (see note 1)	Sets origin compensation value (angle data). Factory setting "0."	
	2	Backlash compensation value	<input type="checkbox"/> 2	0 to 179 (0 to 359) (see note 1)	Sets backlash compensation value (angle data). Factory setting "0."	
	3	Advance angle compensation value 1	<input type="checkbox"/> 2	0 to 1600 (0 to 800) (see note 1)	Sets speed data for advance angle compensation value 1. Factory setting "0."	
				0 to 359 (0 to 719) (see note 1)	Sets angle data for advance angle compensation value 1. Factory setting "0."	
	4	Advance angle compensation value 2	<input type="checkbox"/> 2	0 to 1600 (0 to 800) (see note 1)	Sets speed data for advance angle compensation value 2. Factory setting "0."	
				0 to 359 (0 to 719) (see note 1)	Sets angle data for advance angle value 2. Factory setting "0."	
5	Advance angle compensation value 3	<input type="checkbox"/> 2	0 to 359 (0 to 719) (see note 1)	Sets angle data for advance angle compensation value 3 (advance angle compensated position). Factory setting "0."		
6	Baud rate	<input type="checkbox"/> 2	1, 2	1: 9,600 bps (factory setting) 2: 19,200 bps		

FUN No.	PRMTR No.	Function	Function level for settings	Setting range	Settings	Settings
H (h)	1	Backlash compensation enable/disable setting	2	0, 1	0: Backlash compensation disabled (factory setting) 1: Backlash compensation enabled	
	2	Advance angle compensation enable/disable setting	2	0, 1	0: Advance angle compensation disabled (factory setting) 1: Advance angle compensation enabled	
	3	Output hold	2	0, 1	0: Output hold disabled (factory setting) 1: Output hold enabled	
	4	Present value output setting	2	0 to 4	0: No present value output function (factory setting) 1: 4-digit present angle (no units) 2: 4-digit number of rotations (no units) 3: Automatic switching of 3-digit present angle and number of rotations (with units) 4: Automatic switching of 4-digit present angle and number of rotations (with units)	

**Note 1.** The data for 720 resolution (divisions/revolution) is shown in parentheses. The angles will be set and displayed as “1” for 0.5°.

**Note 2.** The power must be turned OFF and then ON again to enable these functions.

● Cam Protect Settings (Function No. C (c), Function Level: 2)

○: Cam protect

Fill in the bit corresponding to the cam number for which cam data protect has been set. This makes it easier to display and compare the cam data protect statuses.

Bank No. 1

1	2	3	4	5	6	7	8	9	10	11	12	13	14	15	16
17	18	19	20	21	22	23	24	25	26	27	28	29	30	31	32

Bank No. 2

1	2	3	4	5	6	7	8	9	10	11	12	13	14	15	16
17	18	19	20	21	22	23	24	25	26	27	28	29	30	31	32

Bank No. 3

1	2	3	4	5	6	7	8	9	10	11	12	13	14	15	16
17	18	19	20	21	22	23	24	25	26	27	28	29	30	31	32

Bank No. 4

1	2	3	4	5	6	7	8	9	10	11	12	13	14	15	16
17	18	19	20	21	22	23	24	25	26	27	28	29	30	31	32

Bank No. 5

1	2	3	4	5	6	7	8	9	10	11	12	13	14	15	16
17	18	19	20	21	22	23	24	25	26	27	28	29	30	31	32

Bank No. 6

1	2	3	4	5	6	7	8	9	10	11	12	13	14	15	16
17	18	19	20	21	22	23	24	25	26	27	28	29	30	31	32

Bank No. 7

1	2	3	4	5	6	7	8	9	10	11	12	13	14	15	16
17	18	19	20	21	22	23	24	25	26	27	28	29	30	31	32

Bank No. 8

1	2	3	4	5	6	7	8	9	10	11	12	13	14	15	16
17	18	19	20	21	22	23	24	25	26	27	28	29	30	31	32

Bank No. 1

Bank No. 2

Bank No. 3

Bank No. 4

Bank No. 5

Bank No. 6

Bank No. 7

Bank No. 8

**Note** The power must be turned OFF and then ON again to enable this function.

Cam Protect Status Display

• SPEED/ON

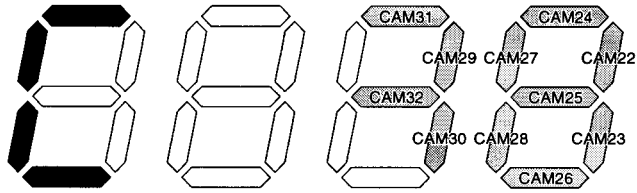

• POSITION/OFF

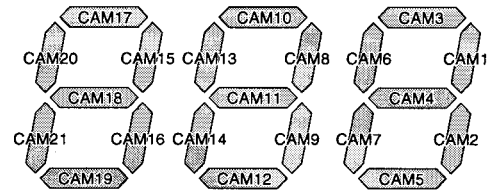

● One-direction Function Setting (Function No. F (f), Function Level: 2)

0: One-direction function disabled (factory setting)  
 1: Forward direction function enabled  
 2: Reverse direction enabled

Bank No. 1

1	2	3	4	5	6	7	8	9	10	11	12	13	14	15	16
17	18	19	20	21	22	23	24	25	26	27	28	29	30	31	32

Bank No. 2

1	2	3	4	5	6	7	8	9	10	11	12	13	14	15	16
17	18	19	20	21	22	23	24	25	26	27	28	29	30	31	32

Bank No. 3

1	2	3	4	5	6	7	8	9	10	11	12	13	14	15	16
17	18	19	20	21	22	23	24	25	26	27	28	29	30	31	32

Bank No. 4

1	2	3	4	5	6	7	8	9	10	11	12	13	14	15	16
17	18	19	20	21	22	23	24	25	26	27	28	29	30	31	32

Bank No. 5

1	2	3	4	5	6	7	8	9	10	11	12	13	14	15	16
17	18	19	20	21	22	23	24	25	26	27	28	29	30	31	32

Bank No. 6

1	2	3	4	5	6	7	8	9	10	11	12	13	14	15	16
17	18	19	20	21	22	23	24	25	26	27	28	29	30	31	32

Bank No. 7

1	2	3	4	5	6	7	8	9	10	11	12	13	14	15	16
17	18	19	20	21	22	23	24	25	26	27	28	29	30	31	32

Bank No. 8

1	2	3	4	5	6	7	8	9	10	11	12	13	14	15	16
17	18	19	20	21	22	23	24	25	26	27	28	29	30	31	32

**Note** The power must be turned OFF and then ON again to enable this function.

# Index

## Numbers

4-digit display, wiring, 2-27

## A, B

adjustment operation, 3-93

advance angle compensation, 3-62  
and teaching, 3-87

angle resolution, 1-2

applied functions, 1-4, 1-12, 3-44–3-96

backlash compensation, 3-60–3-62  
and teaching, 3-87

bank number  
bank selection inputs, 3-42  
deleting programs by bank number, 3-34  
switching time, 7-6

bank selection inputs, 3-42

baud rate setting, 3-90

## C

cam number, deleting program by cam number, 3-33

cam output  
cam output function, 1-3  
delay time, 7-4, 7-7  
monitoring, 3-41  
OFF time, 7-5  
specifications, 2-25  
wiring, 2-22

Cam Positioner  
installation, 2-6  
replacement, 5-13  
RS-232C connections, 3-88  
specifications, 6-2  
standard models, 7-11

cam program  
cam programming sheet, 7-21  
checking in PRGM mode, 3-24, 3-31–3-32  
checking number of steps, 3-26, 3-35–3-37  
creating and checking, 3-24–3-36  
creation in PRGM mode, 3-24, 3-27–3-30  
deleting, 3-32  
write function, 1-3

cam protect error, 3-92

cam protect function, 3-69–3-75  
cam protect settings, 7-24

chains, using, 2-12

colors, cam output cable colors, 2-24

command frame, 4-5–4-6

commands, FINS commands, 4-10

communications  
CompoWay/F communications, 4-1–4-28  
specifications, 4-3

communications error, 3-92, 5-7–5-8

communications ports, RS-232C connections, 3-88

components, name and function of each part, 1-7

CompoWay/F Communications  
commands, 4-10  
Controller Data Read command, 4-19  
Controller Status Read command, 4-20  
errors, 5-7–5-8  
Internode Echo Test command, 4-22  
Memory Area Read command, 4-10  
Operation Command, 4-21  
overview, 4-2–4-4  
Parameter Area Read command, 4-12  
Unit Attribute Read command, 4-20

Connection Cables, models, 2-14

connections, wiring connections, 2-13

connectors, functions, 1-9

control inputs  
description, 3-42–3-43  
monitoring, 3-41  
specifications, 2-19  
wiring, 2-17

control outputs  
description, 3-43  
monitoring, 3-41  
specifications, 2-20  
wiring, 2-19

copy function, 1-5, 3-88–3-92

Coupling. *See* Resolver Coupling

crimp terminals, recommended terminals, 2-18, 2-20

CW/CCW setting switch, using, 3-21

## D

data output timing, 3-80

data transfer, 3-88

deleting cam program, 3-32  
deleting all cam programs, 3-35  
in PRGM mode, 3-25

direction of rotation  
one-direction function, 3-75  
setting, 3-21

# Index

---

display  
display changes in SET mode, 3-52–3-56  
displays by mode, 3-8, 7-12–7-15  
functions, 1-8  
nomenclature of display section, 3-2  
seven-segment display patterns, 3-3  
specifications, 6-8

Display Unit  
connecting, 2-5, 2-13, 2-25–2-29  
standard models, 7-11

## E

EC Directives, conformance, 2-9  
environmental conditions, 2-8  
error codes, 5-2–5-7, 7-16–7-20  
error output, 3-43  
delay time, 7-4  
errors  
communications errors, 3-92  
diagnosing with error codes, 5-2–5-6  
displaying, 3-40  
error codes, 5-2–5-7, 7-16–7-20  
error codes in FINS response frames, 4-8  
error output, 3-43  
examples, application examples, 7-2–7-3

## F

FINS communications. *See* CompoWay/F communications  
function level, selecting, 3-44–3-45  
function level 0, selecting, 3-14  
function level 1  
selecting, 3-14  
using, 1-11, 3-12  
function level 2  
selecting, 3-14  
using, 1-12, 3-13  
functions  
basic functions, 1-3  
by mode, 3-4  
functions allowed in each function level, 3-14–3-20  
program functions, 3-24–3-26

## G, H

gears, using, 2-12  
glossary, glossary of terms, 1-10  
host computer, communications with, 4-2

## I, K

I/O Block  
cam outputs for, 2-23  
connecting, 2-4, 2-13  
specifications, 6-6–6-7  
standard models, 7-11  
I/O monitor function, 3-40  
initial settings  
descriptions, 3-21–3-23  
functions, 1-4  
inspection, regular inspections, 5-12  
installation, 2-6  
Cam Positioners, 2-6  
environmental conditions, 2-8  
Resolvers, 2-7  
internode echo test, 4-22  
keys. *See* operation keys

## M, N

M-DET output  
OFF delay time, 7-6  
ON delay time, 7-6  
maintenance, 5-12  
Master Cam Positioner Settings, 3-91  
modes, 1-3, 3-4–3-11  
changing, 3-4  
monitoring operation, 3-40  
noise, wiring to reduce noise, 2-14

## O

one-direction function, 3-75–3-77  
settings, 7-26  
operation  
basic operation, 1-2  
nomenclature of operation section, 3-2  
procedure, 1-11, 3-12–3-13  
operation keys, 1-9  
functions in PRGM mode, 3-28  
origin compensation, 3-56–3-59  
and origin shift, 3-38  
executing, 3-37–3-38, 3-58  
origin compensation absolute angle, 3-58  
origin compensation value, 3-57  
origin shift, 3-56–3-59  
and origin compensation, 3-38  
executing, 3-59  
origin shift input, 3-43  
processing time, 7-5  
output hold function, 3-77–3-78  
output timing, data output timing, 3-80



# Index

---

## P

parameters  
advance angle compensation values, 3-62, 3-67–3-69  
backlash compensation enable/disable, 3-61, 3-69  
backlash compensation value, 3-60  
baud rate setting, 3-90  
cam protect settings, 3-70  
data transfer (Master Unit settings), 3-90  
data transfer (Slave Unit settings), 3-90  
displaying and setting, 3-50  
explanation and operation, 3-49–3-55  
log chart, 7-22  
one-direction function setting, 3-75  
origin compensation absolute angle, 3-58  
origin compensation value, 3-57  
output hold, 3-77  
parameter list, 3-45  
present value output setting, 3-78  
pulse output setting, 3-81  
reading parameter area, 4-12  
teaching setting, 3-83

parts, name and function of each part, 1-7

performance, 7-4

peripheral devices, reducing noise, 2-15

personal computer, communications with, 4-2

PMCR instruction, 4-24

power supply, wiring, 2-16

present angle  
displaying, 2-5, 2-28  
monitoring, 3-40  
reading from OMRON PC, 7-2

present value output, 3-78–3-80

PRGM mode  
displays, 3-11  
function, 1-3

procedure, operation procedure, 3-12

processing time, 7-4

program. *See* cam program

program functions, outline, 3-24

Programmable Controller  
communications with, 4-2  
connecting, 2-13  
reading present value output from, 7-2

protocol macros , executing CompoWay/F commands with, 4-23

pulse output function, 3-80–3-83

## R

relay output, 2-4

reset input, 3-43

resolution, 1-2  
setting, 3-22

Resolver  
Cables, 2-3  
connecting, 2-3, 2-13  
connection to machinery, 3-37  
installation, 2-7  
life expectancy, 7-8  
mounting, 2-9  
specifications, 6-4–6-5  
standard models, 7-11  
wiring, 2-21

Resolver Cables, 2-22, 6-4

Resolver Coupling  
connecting with, 2-10  
life expectancy, 7-9  
precautions, 2-11  
replacement, 5-12  
specifications, 2-10

Resolver speed  
displaying, 2-28  
monitoring, 3-40

response frame, 4-7–4-10

rotation detection output, 3-43

rotation direction, setting, 3-21

RS-232C Cables  
Cam Positioner connections, 3-88  
connection to a PC or host computer, 4-3  
specifications, 4-4

RUN mode  
displays, 3-11  
function, 1-3  
starting operation, 3-38–3-39

RUN output, 3-43  
delay time, 7-4  
OFF time, 7-5

## S

safety measures, 2-2

SET mode  
displays, 3-8  
function, 1-3  
selecting the function level, 3-20

Slave Cam Positioner Settings, 3-91

specifications, 6-1–6-10  
cam output, 2-25  
Cam Positioner, 6-2  
communications, 4-3  
control inputs, 2-19  
control outputs, 2-20  
display, 6-8  
I/O Block, 6-6  
Resolver, 2-2, 6-4  
Resolver Coupling, 2-10

speed  
monitoring Resolver speed, 3-40  
permissible resolver speed, 1-2

# Index

---

standard models, 7-11  
start input, 3-42  
start operation, 3-38  
steps  
  checking number of program steps, 3-26, 3-35–3-37  
  deleting by steps, 3-32  
switches  
  functions, 1-8  
  location, 1-7  
system configuration, 1-6  
system design, 2-2

## T

teaching function, 3-83–3-87  
Terminal Block, wiring, 2-16  
terminal block, function, 1-9  
terminals, 2-18, 2-20  
time chart, example, 3-27

timing, data output timing, 3-80  
timing belt, using, 2-12  
timing compensation, 3-63  
transferring cam programs and parameters, 3-91  
transistor output, open collector, 2-4  
trial operation, 3-93  
troubleshooting, 5-9–5-11

## V, W

verification error, 3-92  
wiring, 2-13  
  4-digit display, 2-27  
  cam output, 2-22  
  control inputs, 2-17  
  control outputs, 2-19  
  power supply input, 2-16  
  Resolver, 2-21  
  standard method, 2-14  
  Terminal Blocks, 2-16  
write-protection, write-protecting cam data, 3-69

# Revision History

A manual revision code appears as a suffix to the catalog number on the front cover of the manual.

Cat. No. O008-E1-04

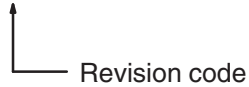

The following table outlines the changes made to the manual during each revision. Page numbers refer to the previous version.

Revision code	Date	Revised content
1	September 1999	Original production
02	July 2005	Following changes made to front matter. <b>Notice:</b> Information on general precautions notation added. <b>Conformance to EC Directives:</b> EN50081-2 changed to EN61000-6-4. <b>Read and Understand this Manual:</b> Information on liability and warranty added.
03	July 2011	General Precautions: Changed the fifth precaution from the start of the general precautions section. <b>Page 3-93:</b> Added note. <b>Page 6-2:</b> Added note..
04	August 2016	Corrected mistakes.





**OMRON Corporation Industrial Automation Company**  
Kyoto, JAPAN

Contact: [www.ia.omron.com](http://www.ia.omron.com)

**Regional Headquarters**

**OMRON EUROPE B.V.**

Wegalaan 67-69, 2132 JD Hoofddorp  
The Netherlands  
Tel: (31)2356-81-300/Fax: (31)2356-81-388

**OMRON ELECTRONICS LLC**

2895 Greenspoint Parkway, Suite 200  
Hoffman Estates, IL 60169 U.S.A.  
Tel: (1) 847-843-7900/Fax: (1) 847-843-7787

**OMRON ASIA PACIFIC PTE. LTD.**

No. 438A Alexandra Road # 05-05/08 (Lobby 2),  
Alexandra Technopark,  
Singapore 119967  
Tel: (65) 6835-3011/Fax: (65) 6835-2711

**OMRON (CHINA) CO., LTD.**

Room 2211, Bank of China Tower,  
200 Yin Cheng Zhong Road,  
PuDong New Area, Shanghai, 200120, China  
Tel: (86) 21-5037-2222/Fax: (86) 21-5037-2200

**Authorized Distributor:**

© OMRON Corporation 1999-2016 All Rights Reserved.  
In the interest of product improvement,  
specifications are subject to change without notice.

**Cat. No. O008-E1-04**

0816