

**Programmable Multi-Axis Controller**

# **Application Guide**

## **Laser Application**

**CK5M-CPU1□1**

**CK3M-CPU1□1**

**CK3W-AX2323□**

**CK3W-GC2200**

**Application  
Starting  
Guide**

## **NOTE**

1. All rights reserved. No part of this publication may be reproduced, stored in a retrieval system, or transmitted, in any form, or by any means, mechanical, electronic, photocopying, recording, or otherwise, without the prior written permission of OMRON.
2. No patent liability is assumed with respect to the use of the information contained herein.  
Moreover, because OMRON is constantly striving to improve its high-quality products, the information contained in this manual is subject to change without notice.
3. Every precaution has been taken in the preparation of this manual. Nevertheless, OMRON assumes no responsibility for errors or omissions.  
Neither is any liability assumed for damages resulting from the use of the information contained in this publication.

## **Trademarks**

- Microsoft, Windows, Excel, Visual Basic, and Microsoft Edge are either registered trademarks or trademarks of Microsoft Corporation in the United States and other countries.
- EtherCAT® is registered trademark and patented technology, licensed by Beckhoff Automation GmbH, Germany.

Other company names and product names in this document are the trademarks or registered trademarks of their respective companies.

## **Copyrights**

- Microsoft product screen shots used with permission from Microsoft.
- This product incorporates certain third party software. The license and copyright information associated with this software is available at [http://www.fa.omron.co.jp/nj\\_info\\_e/](http://www.fa.omron.co.jp/nj_info_e/).

# Sections in this Manual

---

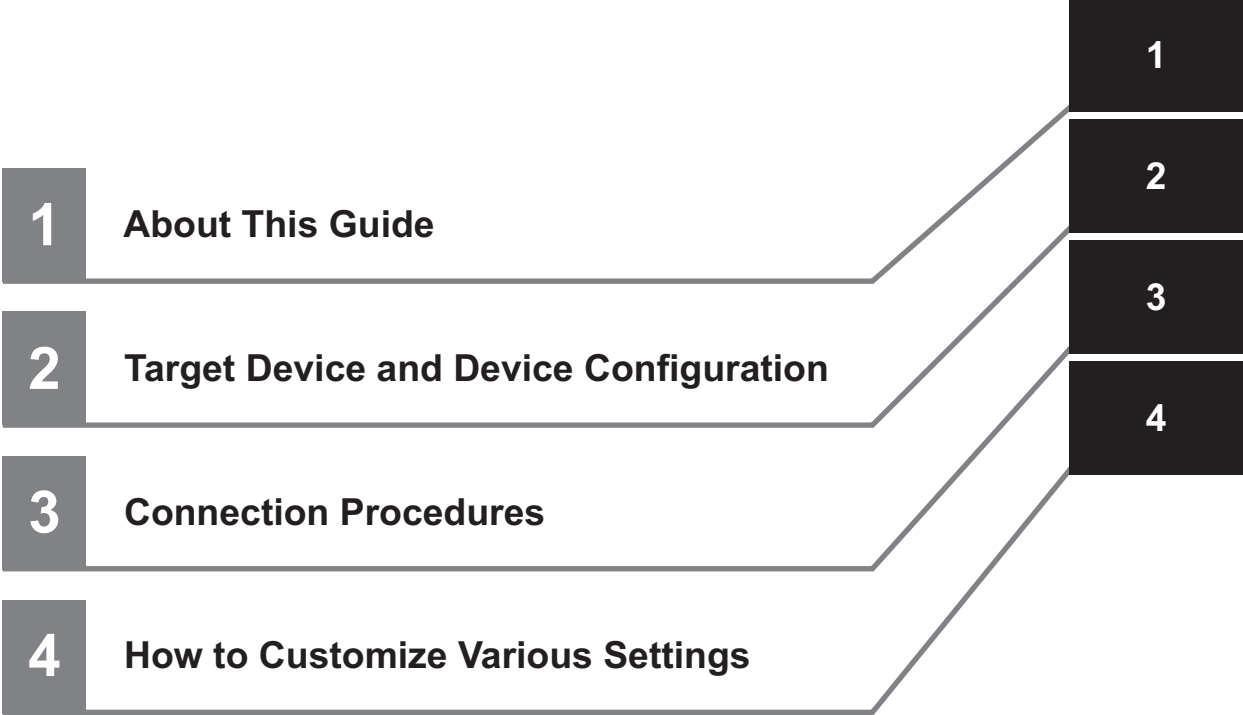

# CONTENTS

---

<b>Sections in this Manual .....</b>	<b>3</b>
<b>Precautions .....</b>	<b>6</b>
Symbols .....	6
<b>Related Manuals.....</b>	<b>7</b>
<b>Terms and Definitions.....</b>	<b>8</b>
<b>Revision History.....</b>	<b>9</b>

## Section 1 About This Guide

---

1-1 Introduction .....	1-2
------------------------	-----

## Section 2 Target Device and Device Configuration

---

2-1 Device Configuration.....	2-2
-------------------------------	-----

## Section 3 Connection Procedures

---

<b>3-1 Work Flow.....</b>	<b>3-2</b>
<b>3-2 Controller Setting Preparations.....</b>	<b>3-4</b>
3-2-1 Creation of a New Project .....	3-4
3-2-2 Controller Initial Setting .....	3-5
<b>3-3 Setup of the MOTF .....</b>	<b>3-7</b>
3-3-1 Programming.....	3-7
3-3-2 Determination of Filter's Coefficients .....	3-13
<b>3-4 Setup of the Motors and Encoder .....</b>	<b>3-21</b>
3-4-1 Wiring Devices .....	3-21
3-4-2 Programming.....	3-22
3-4-3 Tuning of the Current Loop .....	3-26
3-4-4 Establishment of the Phase Reference.....	3-28
3-4-5 Open-loop Testing .....	3-29
3-4-6 Position Loop Auto-tuning.....	3-30
3-4-7 Position Loop Interactive Tuning .....	3-31
3-4-8 Tuning of the Y Axis .....	3-35
3-4-9 Confirmation of the Tuning Results .....	3-36
<b>3-5 Setup of Overtravel Limit Switches and Home Positions .....</b>	<b>3-39</b>
3-5-1 Wiring of Devices .....	3-39
3-5-2 Programming.....	3-39
3-5-3 Confirmation of the Settings (Overtravel Limit Switches).....	3-41
3-5-4 Setup of Home Positions.....	3-42
<b>3-6 Setup of the Galvo Scanner .....</b>	<b>3-44</b>
3-6-1 Wiring of Devices .....	3-44
3-6-2 Programming.....	3-45
3-6-3 Setup of Control Commands.....	3-47
3-6-4 Confirmation of the Settings.....	3-49
3-6-5 Verification of the MOTF on the Actual Machine.....	3-50
<b>3-7 Setup of the Laser Oscillator .....</b>	<b>3-51</b>

3-7-1	Wiring of Devices .....	3-51
3-7-2	Guide Laser Output.....	3-51
3-7-3	Programming.....	3-53
3-7-4	Setup of the Laser Oscillator.....	3-56
3-7-5	Confirmation of the Settings.....	3-58

## Section 4    How to Customize Various Settings

---

4-1	globaldefinitions.pmh.....	4-2
4-2	MotionOnTheFly.pmh .....	4-3
4-3	MotorControl.pmh.....	4-4
4-4	SensorControl.pmh .....	4-7
4-5	Galvano.pmh .....	4-8
4-6	LaserControl.pmh .....	4-10
4-7	TCRConfigurations.pmh .....	4-11

# Precautions

---

- For actual system construction, check the specifications for devices and equipment that make up the system, use a method with sufficient margin for ratings and performance, and adopt safety circuits and other safety measures to minimize risks even if a breakdown occurs.
- To safely use the system, obtain manuals or user's guides for devices and equipment that make up the system, and confirm and understand the precautions related to safety such as "Safety Precautions" and "Precautions for Safe Use", and other contents of the manuals or user's guides, including "Precautions for Correct Use", before use.
- The customer themselves must check all regulations, laws, and rules that are applicable to the system.
- No part or the whole of this document may be copied, duplicated, or redistributed without the permission of OMRON Corporation.
- The contents of this document may be subject to change without notice for the purpose of improvement.

Special information in this document is classified as follows:



## **Precautions for Correct Use**

---

Precautions on what to do and what not to do to ensure correct operation and performance.

---



## **Additional Information**

---

Additional information to read as required.

This information is provided to increase understanding and make operation easier.

---

## Symbols

---



The filled circle symbol indicates operations that you must do.

The specific operation is shown in the circle and explained in text.

This example shows a general precaution for something that you must do.

---

# Related Manuals

To safely use the system, obtain manuals or user's guides for devices and equipment that make up the system, and confirm and understand the precautions related to safety such as "Safety Precautions" and "Precautions for Safe Use", and other contents of the manuals or user's guides, including "Precautions for Correct Use", before use.

The manuals provided by OMRON Corporation (hereinafter, "OMRON") and Delta Tau Data Systems Inc. (hereinafter "DT") are as shown below.

Manufacturer	Cat. No.	Model	Manual name
OMRON	O036	CK5M-CPU□□□ CK3M-CPU□□□ CK3W-AX2323□ CK3W-GC2200	Programmable Multi-Axis Controller Hardware User's Manual
DT	O014	---	Power PMAC User's Manual
DT	O015	---	Power PMAC Software Reference Manual
DT	O016	---	Power PMAC IDE User's Manual (V4)

# Terms and Definitions

Term	Description and definition
PMAC	An acronym for Programmable Multi-Axis Controller.
Power PMAC IDE	Computer software that is used to configure the Controller, create user programs, and perform monitoring.
AC servo motor	A servo motor that is driven by AC signal input. A rotating magnetic field is formed in the motor by the input of an AC signal in order to rotate the rotor of the motor.
Servo amplifier	A control device that controls a servo motor. Upon receipt of a command from the Controller, it switches the power by means of a power device in order to output a power signal to drive the motor.
Direct PWM	OMRON's unique communications method for communications between the Power PMAC and the servo amplifier. The Power PMAC directly sends an ON/OFF signal from the power device of the servo amplifier, while the servo amplifier sends a current feedback value to the Power PMAC. This allows the Power PMAC to form a current loop.
Electrical angle	The angle of the rotating magnetic field used to rotate an AC servo motor.
Commutation control	Control for creating a rotating magnetic field with the required electrical angle in order to rotate the motor.
Phase reference	The home of the electrical angle. To perform commutation control, it is necessary to establish a phase reference at first (i.e., phase reference search).
Sinusoidal Encoder	A type of encoder that outputs SIN/COS waveforms at 1 Vpp.
Galvo Scanner	A control device for controlling the angle of rotation of the mirror that reflects laser light for scanning the position where the laser light is irradiated. It utilizes the high response performance of the mirror to ensure high-speed trajectory control.
SL2-100	A type of protocol for communications with digital Galvo Scanners.
Control command	A command that sets the type of data to be sent from the Galvo Scanner to the Controller.
XY stage	A positioning stage that moves in the X-axis and Y-axis directions. Although the response speed is slower than that of a Galvo Scanner, it can scan a larger area due to its wide range of movement.
MOTF	An acronym for Motion On The Fly. It is an algorithm that divides a position command into high frequency components and low frequency components, and distributes them to actuators with different response speeds. In this manual, the high frequency components are commanded to the Galvo Scanner and the low frequency components are commanded to the XY stage.
Pulsed laser	A laser that blinks repeatedly at a specific time interval. In contrast, a device that constantly outputs laser light is called a continuous oscillation laser.
Q-switching	An oscillation method for pulsed lasers. It uses external oscillation pulse input to obtain pulsed laser output.
TCR	An acronym for Trigger Output by Commanded distance for Rapid Processing. It provides the function to trigger a laser output according to the distance set in the CK3W-GC□2□□.



# Revision History

---

A manual revision code appears as a suffix to the catalog number on the front and back covers of the manual.

**Cat. No. O052-E1-02**

↑  
Revision code

Revision code	Date	Revised content
01	May 2021	Original production
02	January 2023	<ul style="list-style-type: none"><li>• Revision due to change of applicable Servo Drives</li><li>• Corrected mistakes.</li></ul>





# About This Guide

This section provides an introduction of this document.

---

1-1 Introduction ..... 1-2

# 1-1 Introduction

---

This document describes the procedure for assembling a laser processing system using the OMRON Programmable Multi-Axis Controller CK□M-□□□□ (hereafter referred to as “Controller”).



## CAUTION

The scope of this document is to confirm the connection of devices listed as the connection targets. To configure a system using instructions that are not described in this document, obtain manuals or user's guides for devices and equipment that make up the system, and confirm their contents including the precautions related to safety such as “Safety Precautions” and “Precautions for Safe Use” before use.



# 2

## Target Device and Device Configuration

This section lists the target equipment and system configurations for connections in these materials.

---

2-1	Device Configuration .....	2-2
-----	----------------------------	-----

## 2-1 Device Configuration

The configuration devices for reproducing the connection procedures in this document are shown below.

Manufacturer	Name	Model	Version
OMRON	Programmable Multi-Axis Controller CPU Unit	CK□M-CPU1□1	Ver. 2.6.1 or later
OMRON	Programmable Multi-Axis Controller Axis Interface Unit	CK3W-AX2323N*1	---
OMRON	Programmable Multi-Axis Controller Galvano Interface Unit	CK3W-GC2200	---
OMRON	Programmable Multi-Axis Controller Power Supply Unit	CK3W-PD048	---
OMRON	Programmable Multi-Axis Controller End Cover	CK3W-TER11	---
OMRON	Programmable Multi-Axis Controller Direct PWM Cable	CK3W-CAAD036A	---
OMRON	Programmable Multi-Axis Controller Serial Encoder Cable	CK3W-CAES03A	---
OMRON	Programmable Multi-Axis Controller Laser Interface Unit Cable	CK3W-CAG03A	---
OMRON	Switch Mode Power Supply (24 VDC)	S8VK-S12024	---
OMRON	Switch Mode Power Supply (5 VDC)	S8VK-G03005	---
OMRON	Switch Mode Power Supply (15 VDC)	S8FS-G10015CD	---
OMRON	Solid State Relay	G3RV-SR500-D DC24	---
OMRON	Photomicro Sensor	EE-SX674	---
OMRON	Direct PWM Amplifier	CK3A-G310L*1	---
Maxphotonics	Laser Oscillator	MFP	---
INNO6	Linear Motor (Y Axis)	INC-5716-D0-0S	---
INNO6	Linear Motor (X Axis)	INC-5723-D0-0S	---
HEIDENHEIN	Linear Encoder	LIDA48*1	---
SCANLAB	Galvo Scanner	intelliSCAN	---
SCANLAB	fθ Lens	---	---
SCANLAB	Dynamic Focusing Unit	varioSCAN	---
---	Windows PC	---	---
DT	Power PMAC Setting Tool	Power PMAC IDE	Ver. 4.5 or later

\*1. This document assumes that the XY stage is controlled by the Direct PWM or Sinusoidal Encoder method. To use other control methods, change the settings in *3-4 Setup of the Motors and Encoder* on page 3-21 according to the corresponding Startup Guide.







# 3

## Connection Procedures

This section describes the procedures to connect the Controller and the devices that make up the laser application. The description assumes that the Controller is set to factory default.

---

<b>3-1</b>	<b>Work Flow .....</b>	<b>3-2</b>
<b>3-2</b>	<b>Controller Setting Preparations .....</b>	<b>3-4</b>
3-2-1	Creation of a New Project .....	3-4
3-2-2	Controller Initial Setting .....	3-5
<b>3-3</b>	<b>Setup of the MOTF .....</b>	<b>3-7</b>
3-3-1	Programming .....	3-7
3-3-2	Determination of Filter's Coefficients .....	3-13
<b>3-4</b>	<b>Setup of the Motors and Encoder .....</b>	<b>3-21</b>
3-4-1	Wiring Devices .....	3-21
3-4-2	Programming .....	3-22
3-4-3	Tuning of the Current Loop .....	3-26
3-4-4	Establishment of the Phase Reference .....	3-28
3-4-5	Open-loop Testing .....	3-29
3-4-6	Position Loop Auto-tuning .....	3-30
3-4-7	Position Loop Interactive Tuning .....	3-31
3-4-8	Tuning of the Y Axis .....	3-35
3-4-9	Confirmation of the Tuning Results .....	3-36
<b>3-5</b>	<b>Setup of Overtravel Limit Switches and Home Positions .....</b>	<b>3-39</b>
3-5-1	Wiring of Devices .....	3-39
3-5-2	Programming .....	3-39
3-5-3	Confirmation of the Settings (Overtravel Limit Switches) .....	3-41
3-5-4	Setup of Home Positions .....	3-42
<b>3-6</b>	<b>Setup of the Galvo Scanner .....</b>	<b>3-44</b>
3-6-1	Wiring of Devices .....	3-44
3-6-2	Programming .....	3-45
3-6-3	Setup of Control Commands .....	3-47
3-6-4	Confirmation of the Settings .....	3-49
3-6-5	Verification of the MOTF on the Actual Machine .....	3-50
<b>3-7</b>	<b>Setup of the Laser Oscillator .....</b>	<b>3-51</b>
3-7-1	Wiring of Devices .....	3-51
3-7-2	Guide Laser Output .....	3-51
3-7-3	Programming .....	3-53
3-7-4	Setup of the Laser Oscillator .....	3-56
3-7-5	Confirmation of the Settings .....	3-58

# 3-1 Work Flow

The procedures for building a laser application are shown below.

<b>3-2 Controller Setting Preparations on page 3-4</b>	Perform the Controller setting preparations.
▼	
3-2-1 Creation of a New Project on page 3-4	
▼	
3-2-2 Controller Initial Setting on page 3-5	
▽	
<b>3-3 Setup of the MOTF on page 3-7</b>	Set up the MOTF.
▼	
3-3-1 Programming on page 3-7	
▼	
3-3-2 Determination of Filter's Coefficients on page 3-13	
▽	
<b>3-4 Setup of the Motors and Encoder on page 3-21</b>	Set up the motors and encoder.
▼	
3-4-1 Wiring Devices on page 3-21	
▼	
3-4-2 Programming on page 3-22	
▼	
3-4-3 Tuning of the Current Loop on page 3-26	
▼	
3-4-4 Establishment of the Phase Reference on page 3-28	
▼	
3-4-5 Open-loop Testing on page 3-29	
▼	
3-4-6 Position Loop Auto-tuning on page 3-30	
▼	
3-4-7 Position Loop Interactive Tuning on page 3-31	
▼	
3-4-8 Tuning of the Y Axis on page 3-35	
▼	
3-4-9 Confirmation of the Tuning Results on page 3-36	
▽	
<b>3-5 Setup of Overtravel Limit Switches and Home Positions on page 3-39</b>	Set up various sensors.
▼	
3-5-1 Wiring of Devices on page 3-39	
▼	
3-5-2 Programming on page 3-39	
▼	
3-5-3 Confirmation of the Settings (Overtravel Limit Switches) on page 3-41	
▼	

3-5-4 Setup of Home Positions on page 3-42	
▽	
<b>3-6 Setup of the Galvo Scanner on page 3-44</b>	Set up the Galvo Scanner.
▼	
3-6-1 Wiring of Devices on page 3-44	
▼	
3-6-2 Programming on page 3-45	
▼	
3-6-3 Setup of Control Commands on page 3-47	
▼	
3-6-4 Confirmation of the Settings on page 3-49	
▼	
3-6-5 Verification of the MOTF on the Actual Machine on page 3-50	
▽	
<b>3-7 Setup of the Laser Oscillator on page 3-51</b>	Set up the laser oscillator.
▼	
3-7-1 Wiring of Devices on page 3-51	
▼	
3-7-2 Guide Laser Output on page 3-51	
▼	
3-7-3 Programming on page 3-53	
▼	
3-7-4 Setup of the Laser Oscillator on page 3-56	
▼	
3-7-5 Confirmation of the Settings on page 3-58	

## 3-2 Controller Setting Preparations

Perform the Controller setting preparations.  
Install the Power PMAC IDE on the PC beforehand.

### 3-2-1 Creation of a New Project

Follow the procedure below to create a new project.

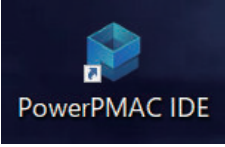
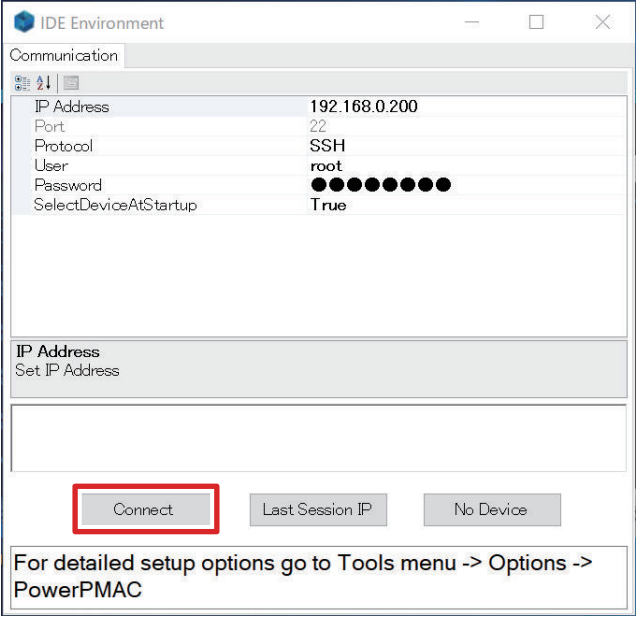
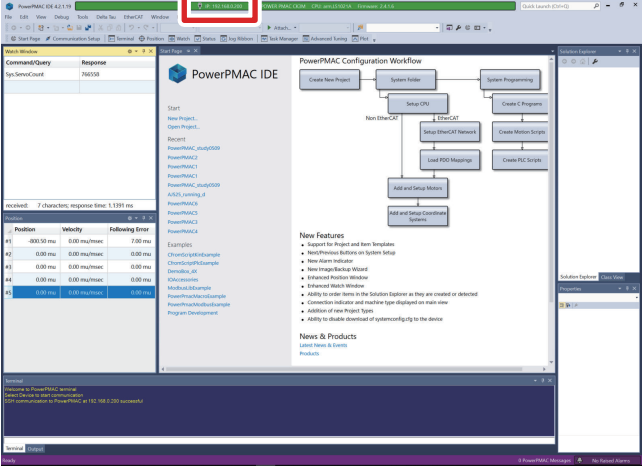
1	Connect the Controller and computer with an Ethernet cable.	
2	Turn ON the power supply to the Controller.	
3	<p>Start up Power PMAC IDE.</p> <ul style="list-style-type: none"> <li>If a dialog for checking access rights is displayed at the time of startup, select the option for starting up.</li> </ul>	
4	<p>The Communication screen is displayed, so specify the IP address of the Controller to be connected to, and click the <b>Connect</b> button.</p> <ul style="list-style-type: none"> <li>The default IP address for the Controller is "192.168.0.200".</li> <li>If necessary, change the Windows IP address to "192.168.0.X".</li> </ul>	
5	Power PMAC IDE starts up, and the Controller will come online.	

- 6 From the **File** menu, select **New – Project**.

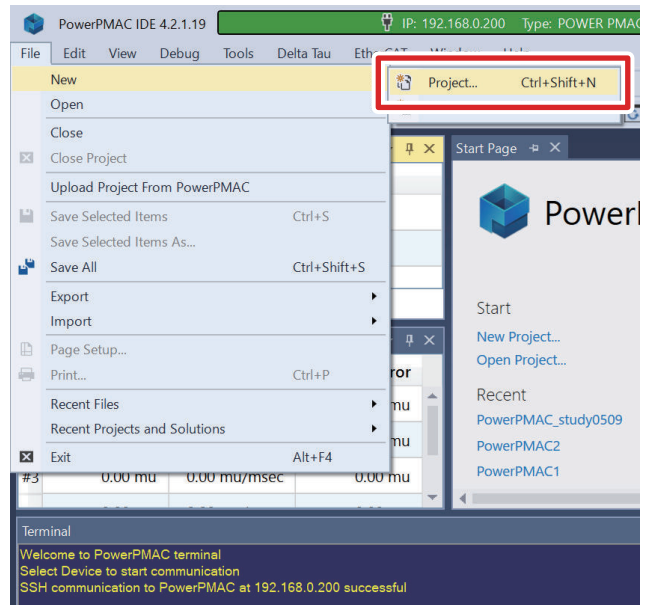

- 7 As shown in the right figure, after you select **Power PMAC**, input a project name and save destination, and select the **OK** button.

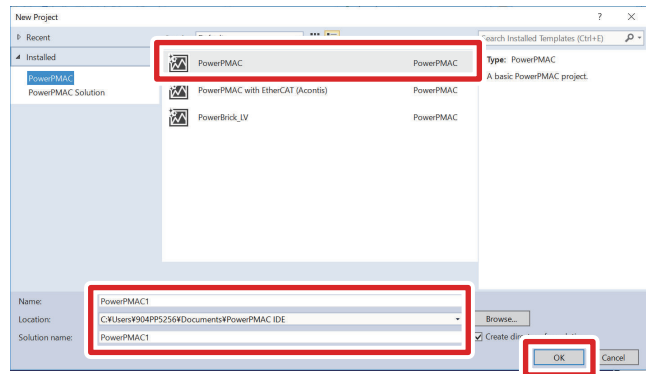

## 3-2-2 Controller Initial Setting

Follow the procedure below to perform the initial settings for the Controller.



### Precautions for Correct Use

Since all memory is cleared by the initial settings, be sure to save any data remaining in the Controller that you may need.

- 1 Type the **\$\$\$\*\*\*** command from the Terminal, and set the Controller to the factory default state.

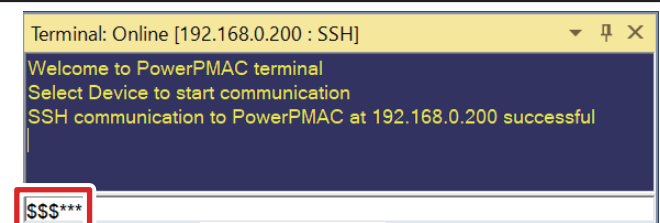

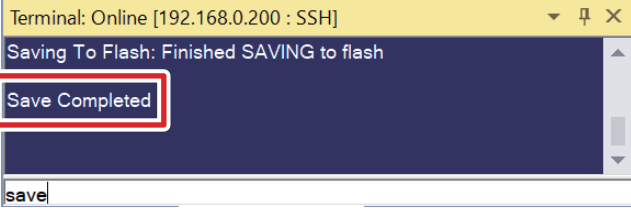
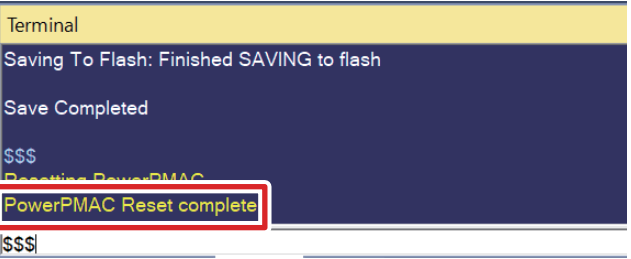
<b>2</b>	<p>Type the <b>save</b> command in the Power PMAC IDE Terminal.</p> <ul style="list-style-type: none"><li>• When the save is completed, "Save Completed" is displayed in the Terminal.</li></ul>	 <p>The screenshot shows a terminal window titled "Terminal: Online [192.168.0.200 : SSH]". The output text is "Saving To Flash: Finished SAVING to flash" followed by "Save Completed" which is highlighted with a red box. The command "save" is visible in the input line at the bottom.</p>
<b>3</b>	<p>Type the <b>\$\$\$</b> command in the Power PMAC IDE Terminal.</p> <ul style="list-style-type: none"><li>• When the reset is completed, "PowerPMAC Reset complete" is displayed in the Terminal.</li></ul>	 <p>The screenshot shows a terminal window titled "Terminal". The output text is "Saving To Flash: Finished SAVING to flash", "Save Completed", "\$\$\$" (highlighted in yellow), "Resetting PowerPMAC", and "PowerPMAC Reset complete" (highlighted with a red box). The command "\$\$\$" is visible in the input line at the bottom.</p>

## 3-3 Setup of the MOTF

### 3-3-1 Programming

Set up the MOTF. This document assumes that you use a low-pass filter with EMA (Exponential Moving Average) to sort a positioning command into low frequency components and high frequency components.

The input/output equation for the EMA is shown below. Here,  $u(n)$  is the input signal at time  $n$  and  $y(n)$  is the output signal.

$$y(n) = KdGain * u(n) + (1 - KdGain) * y(n-1)$$

The following is a block diagram of the MOTF. The low frequency components of a command to an axis that passed through the low-pass filter are input to the motor, whereas the remaining travel distance is input to the Galvo Scanner. This enables high stroke and high responsivity to be compatible.

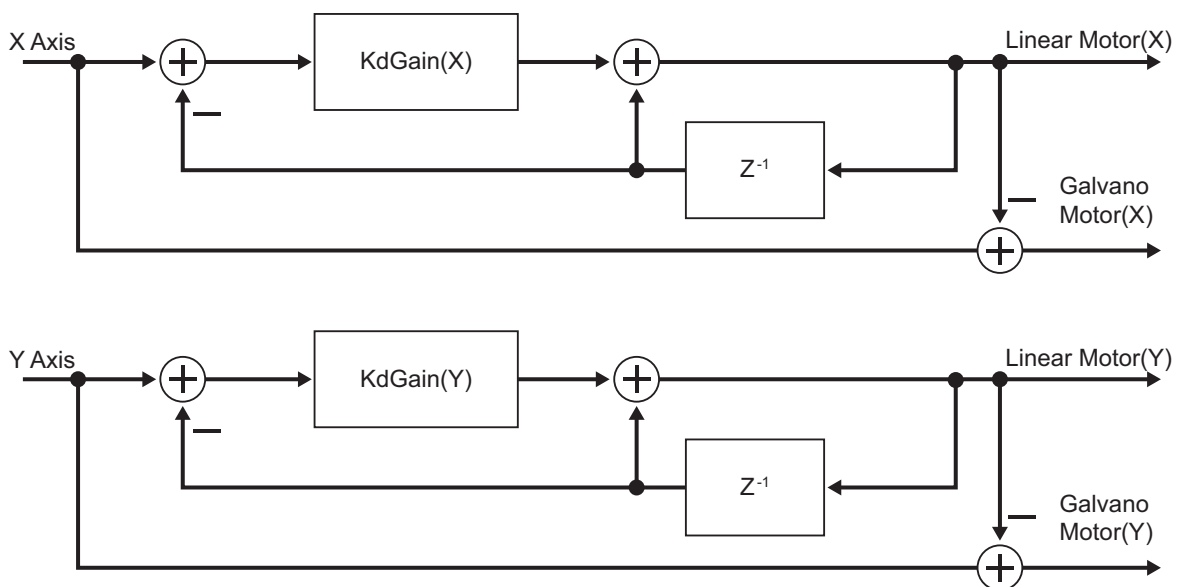

In the above diagram, KdGain is set to 0 or greater, but less than 1. To increase the cutoff frequency of the low-pass filter, set KdGain to a larger value.

The table below shows the relationship between axes on devices and motor numbers in this document.

Axes on devices		Motor number
Machine	Direction	
XY stage	X axis	#1
	Y axis	#2
Galvo Scanner	X axis	#3
	Y axis	#4
Focus unit	Z axis	#5
Virtual axis for TCR calculation		#6

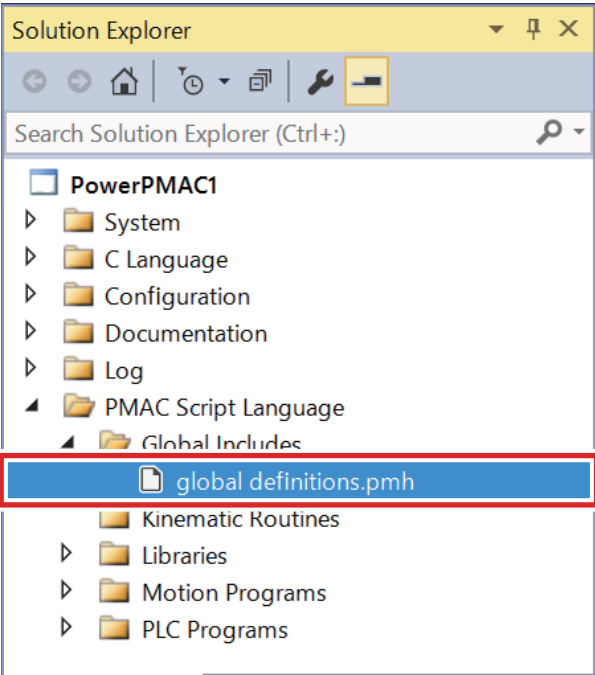
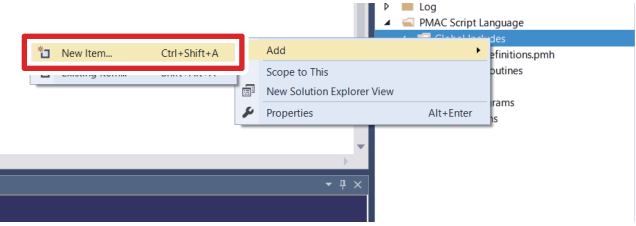
<p><b>1</b></p>	<p>Open the <b>global definitions.pmh</b> file under <b>PMAC Script Language – Global Includes</b> in the Solution Explorer.</p>	
<p><b>2</b></p>	<p>Write the text shown on the right to the global definitions.pmh file.</p> <ul style="list-style-type: none"> <li>For details on the annotated settings, refer to <i>Section 4 How to Customize Various Settings</i> on page 4-1.</li> </ul>	<pre> Sys.WpKey=\$AAAAAAAA //Segmentation Time Coord[1].SegMoveTime=0.1;//*1  //Global Clock Configurations Gate3[0].PhaseFreq=10000;//*2 Gate3[0].ServoClockDiv=0;//*3 Sys.PhaseOverServoPeriod=1;//*4 Sys.ServoPeriod=0.1;//*5 Gate3[0].PhaseServoDir=0;//*6 Gate3[1].PhaseServoDir=3;//*6  //ADC settings Gate3[0].AdcEncCtrl=\$3fffc000         </pre>
<p><b>3</b></p>	<p>In the Solution Explorer, right-click <b>PMAC Script Language</b> and select <b>Add – New Item....</b></p>	



- 4 In the **Name** box, type *MotionOnTheFly.pmh* and click the **Add** button.

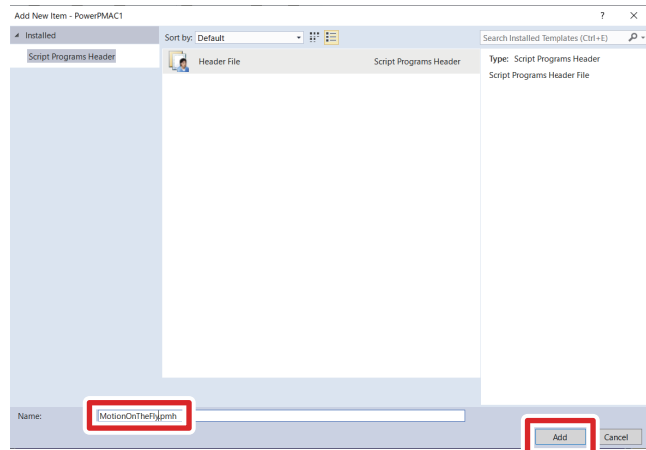

- 5 Open the **MotionOnTheFly.pmh** file under **PMAC Script Language – Global Includes** in the Solution Explorer.

- 6 Write the text shown on the right to the *MotionOnTheFly.pmh* file.
- For details on the annotated settings, refer to *Section 4 How to Customize Various Settings* on page 4-1.

```
//LPF's Gain
global KdgainX=0.00045;/**1
global KdgainY=0.00045;/**2

//Scale Factors of Galvo Scanner
global GalvoSfX=-503316*4096/(170*0.374);/**3
global GalvoSfY=-503316*4096/(170*0.374);/**4

//Settings of Coordinate System
&1;/**5
#1->I;/**5
#2->I;/**5
#3->I;/**5
#4->I;/**5
```

- 7 Open the **pp\_startup.txt** file under **Configuration** in the Solution Explorer.

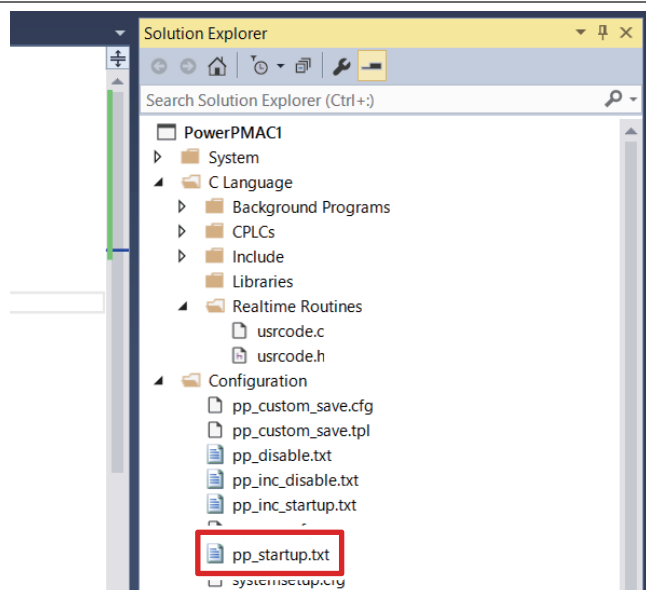

- 8 Write the text shown on the right to the *pp\_startup.txt* file.

```
//Enable CfromScript
UserAlgo.CFunc=1;
```

- 9 In the Solution Explorer, right-click the **usercode.c** file under **C Language – Realtime Routines** and select **Properties**.

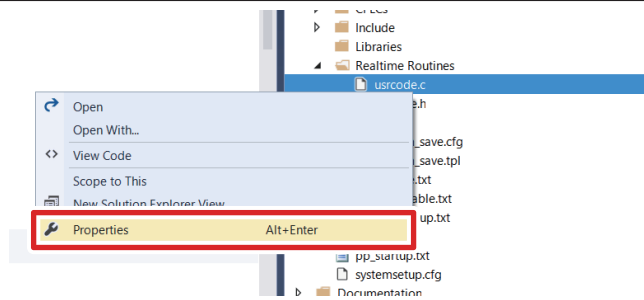

- 10 In **Build Action** in the **Properties** window, select **Compile**.

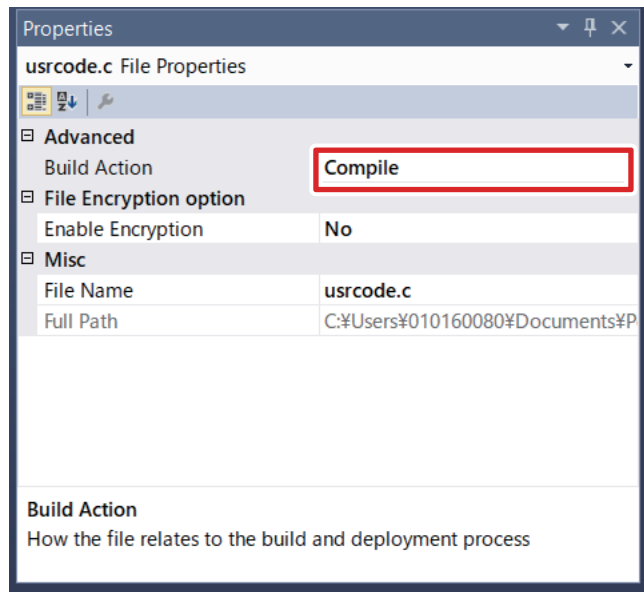

- 11 Open the **usercode.c** file under **C Language – Realtime Routines**.

- 12 Delete the CfromScript function definitions shown on the right.

```
double CfromScript(double cfrom_type,double arg2,
double arg3,double arg4,double arg5,double arg6,d
ouble arg7,struct LocalData *Ldata)
{
    int icfrom_type=(int)cfrom_type;
    double*C,*D,*L,*R,rtn;//C,D,R-only needed if
doing Kinematics

    C=GetCVarPtr(Ldata);//Only needed if doing Ki
nematics
    D=GetDVarPtr(Ldata);//Only needed if doing Ki
nematics
    L=GetLVarPtr(Ldata);//Only needed if using Ld
ata or Kinematics
    R=GetRVarPtr(Ldata);//Only needed if doing Ki
nematics
    rtn=-1.0;
    return rtn;
}
```

**13**

Write the text shown on the right to the usercode.c file.

```
static double prevLpfXPos=0;
static double prevLpfYPos=0;

double CfromScript(double kinTypeDouble,double arg2,double arg3,double arg4,double arg5,double arg6,double arg7,LocalData *Ldata)
{
    int kinType=(int)kinTypeDouble;
    double deltaXPos,deltaYPos;
    double *L=GetLVarPtr(Ldata);
    double *C=GetCVarPtr(Ldata);

    switch(kinType)
    {
        case Forward_Kinematics_State:
        {
            _KinPosAxisX=_KinPosMotor1+(_KinPosMotor3/GalvoSfX);
            _KinPosAxisY=_KinPosMotor2+(_KinPosMotor4/GalvoSfY);
            if(Ldata->Status & 0x40)
            {
                prevLpfXPos=_KinPosMotor1;
                prevLpfYPos=_KinPosMotor2;
            }
            break;
        }
        case Inverse_Kinematics_State:
        {
            deltaXPos=_KinPosAxisX-prevLpfXPos;
            deltaYPos=_KinPosAxisY-prevLpfYPos;
            _KinPosMotor1=prevLpfXPos+(KdgainX*deltaXPos);
            _KinPosMotor2=prevLpfYPos+(KdgainY*deltaYPos);
            _KinPosMotor3=( _KinPosAxisX- _KinPosMotor1)*GalvoSfX;
            _KinPosMotor4=( _KinPosAxisY- _KinPosMotor2)*GalvoSfY;
            prevLpfXPos=_KinPosMotor1;
            prevLpfYPos=_KinPosMotor2;
            break;
        }
    }
    return 0;
}
```

**14**

Add the text shown on the right to the top of the usercode.c file.

```
#define Forward_Kinematics_State 0
#define Inverse_Kinematics_State 1

#define _KinPosAxisX *(C+6)
#define _KinPosAxisY *(C+7)
#define _KinPosMotor1 *(L+1)
#define _KinPosMotor2 *(L+2)
#define _KinPosMotor3 *(L+3)
#define _KinPosMotor4 *(L+4)
```

**15** In the Solution Explorer, right-click **Kinematics Routines** under **PMAC Script Language** and select **Add – New Item...**

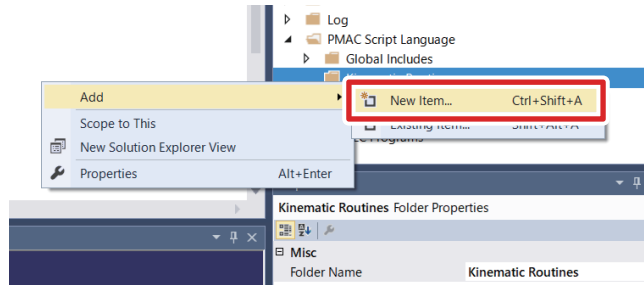

**16** Select **Inverse Kinematic** and click the **Add** button.

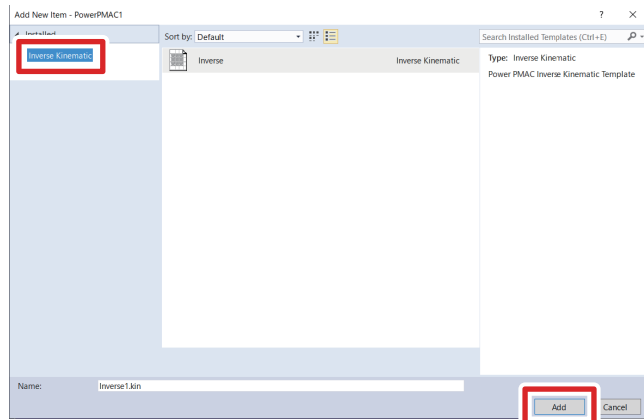

**17** Write the text shown on the right to the Inverse1.kin file.

```
open inverse(1)

local ret;
ret=CfromScript(1,0,0,0,0,0,0);

close
```

**18** In the Solution Explorer, right-click **Kinematics Routines** under **PMAC Script Language** and select **Add – New Item...**

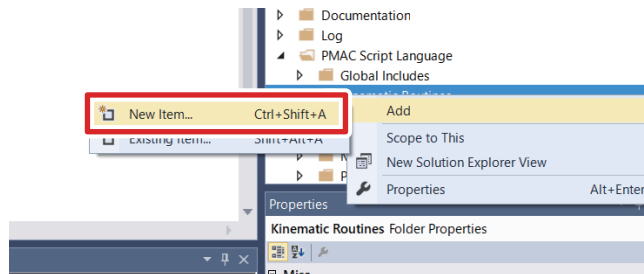

**19** Select **Forward Kinematic** and click the **Add** button.

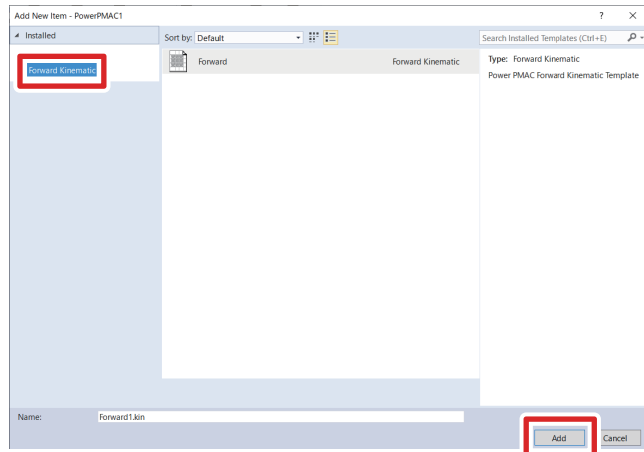

20

Write the text shown on the right to the Forward1.kin file.

```
open forward(1)

local ret;
ret=CfromScript(0,0,0,0,0,0,0);

close
```

### 3-3-2 Determination of Filter's Coefficients

Adjust the KdGain parameter of the filter used for the MOTF.

- 1 In the Solution Explorer, right-click **Global Includes** under **PMAC Script Language** and select **Add – New Item...**

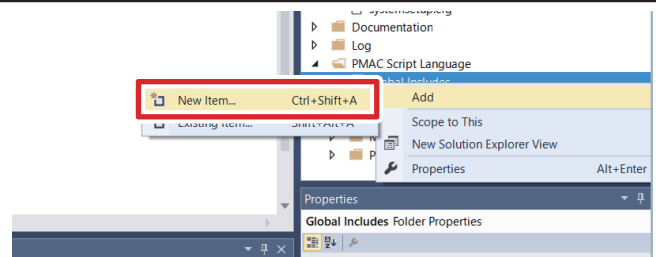

- 2 In the **Name** box, type *VirtualMotor.pmh* and click the **Add** button.

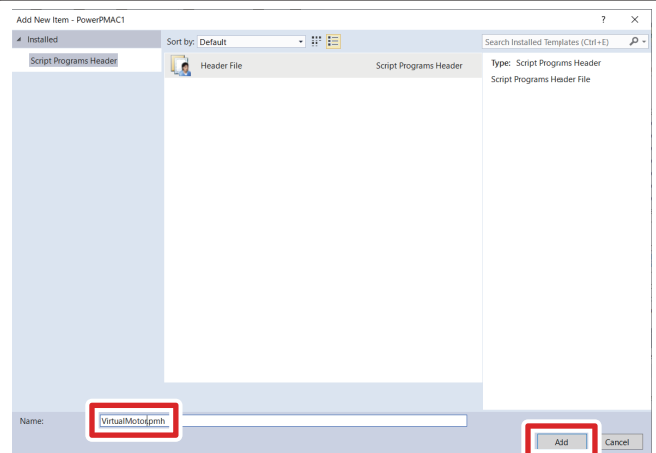

- 3 Open the **VirtualMotor.pmh** file under **PMAC Script Language – Global Includes** in the Solution Explorer.

**4** Write the text shown on the right to the VirtualMotor.pmh file.

```
EncTable[1].type=1
EncTable[1].index1=0
EncTable[1].index2=0
EncTable[1].index3=0
EncTable[1].index4=0
EncTable[1].pEnc1=Sys.udata[10].a
EncTable[1].pEnc =Sys.udata[10].a;
EncTable[1].ScaleFactor=1;
Motor[1].pDac=Sys.udata[10].a
Motor[1].pEnc =EncTable[1].a
Motor[1].pEnc2=EncTable[1].a
Motor[1].pLimits=0
Motor[1].pAmpFault=0
Motor[1].Ctrl=Sys.PosCtrl
Motor[1].ServoCtrl=1
Motor[1].MaxSpeed=0
Motor[1].FatalFeLimit=0

EncTable[2].type=1
EncTable[2].index1=0
EncTable[2].index2=0
EncTable[2].index3=0
EncTable[2].index4=0
EncTable[2].pEnc1=Sys.udata[11].a
EncTable[2].pEnc=Sys.udata[11].a;
EncTable[2].ScaleFactor=1;
Motor[2].pDac=Sys.udata[11].a
Motor[2].pEnc=EncTable[2].a
Motor[2].pEnc2=EncTable[2].a
Motor[2].pLimits=0
Motor[2].pAmpFault=0
Motor[2].Ctrl=Sys.PosCtrl
Motor[2].ServoCtrl=1
Motor[2].MaxSpeed=0
Motor[2].FatalFeLimit=0
```

```

EncTable[3].type=1
EncTable[3].index1=0
EncTable[3].index2=0
EncTable[3].index3=0
EncTable[3].index4=0
EncTable[3].pEnc1=Sys.udata[12].a
EncTable[3].pEnc=Sys.udata[12].a
EncTable[3].ScaleFactor=1
Motor[3].pDac=Sys.udata[12].a
Motor[3].pEnc=EncTable[3].a
Motor[3].pEnc2=EncTable[3].a
Motor[3].pLimits=0
Motor[3].pAmpFault=0
Motor[3].Ctrl=Sys.PosCtrl
Motor[3].ServoCtrl=1
Motor[3].MaxSpeed=0
Motor[3].FatalFeLimit=0

EncTable[4].type=1
EncTable[4].index1=0
EncTable[4].index2=0
EncTable[4].index3=0
EncTable[4].index4=0
EncTable[4].pEnc1=Sys.udata[13].a
EncTable[4].pEnc=Sys.udata[13].a
EncTable[4].ScaleFactor=1
Motor[4].pDac=Sys.udata[13].a
Motor[4].pEnc=EncTable[4].a
Motor[4].pEnc2=EncTable[4].a
Motor[4].pLimits=0
Motor[4].pAmpFault=0
Motor[4].Ctrl=Sys.PosCtrl
Motor[4].ServoCtrl=1
Motor[4].MaxSpeed=0
Motor[4].FatalFeLimit=0

```

- 5** Open the **prog1.pmc** file under **PMAC Script Language – Motion Programs** in the Solution Explorer.

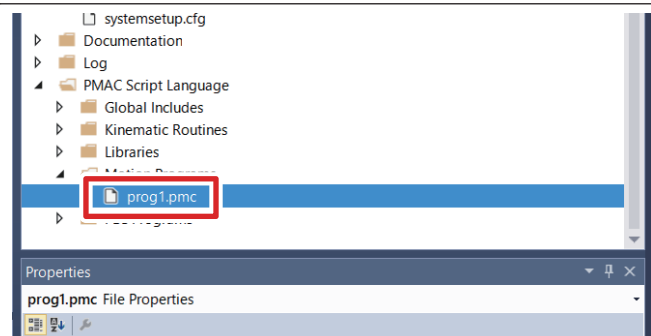

- 6** Write the program to use for processing to the prog1.pmc file.  
The text on the right is an example of the processing program.
- ```

open prog 1

coord[1].FeedTime=1000;
Coord[1].MaxFeedRate=180;

ta(0.1);
td(0.1);
ts(0);
F(100);

abs;
linear;

X(50) Y(50);
X(-50) Y(50);
X(-50) Y(-50);
X(50) Y(-50);
X(50) Y(50);
X(0) Y(0);

close

```

- 7** Download the project.
- Right click on the Solution Explorer project name at the upper right of the Power PMAC IDE screen, select **Build and Download All Programs**, and execute Build and Download.

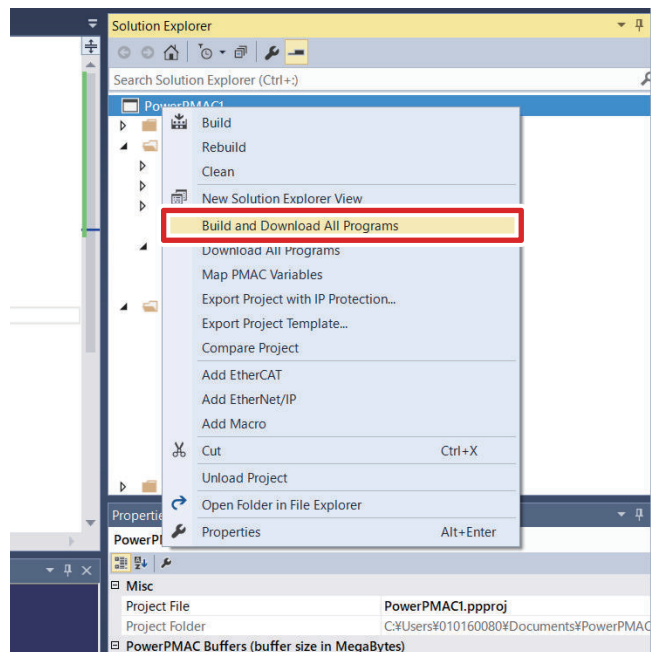

- 8** Make sure that there are no errors in the Output window.
- If the transfer failed, check the content of the error in the Output window.

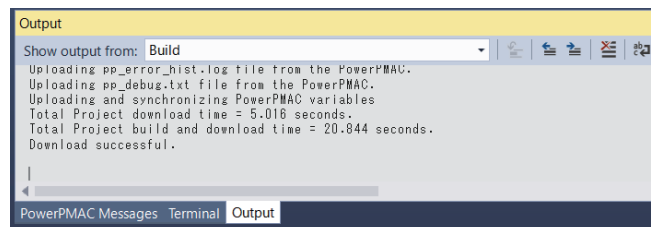

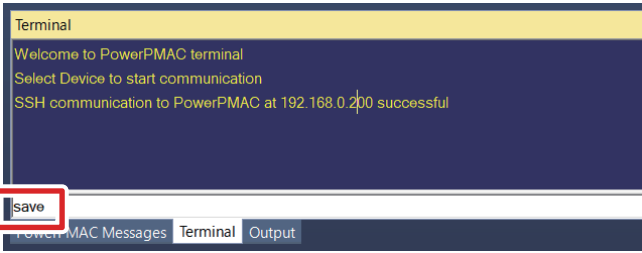
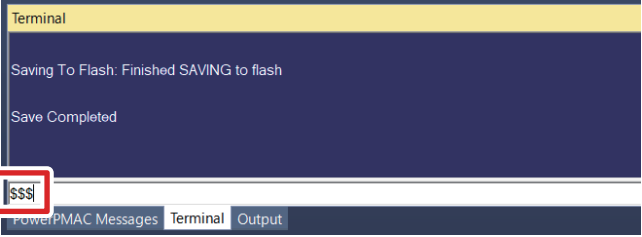
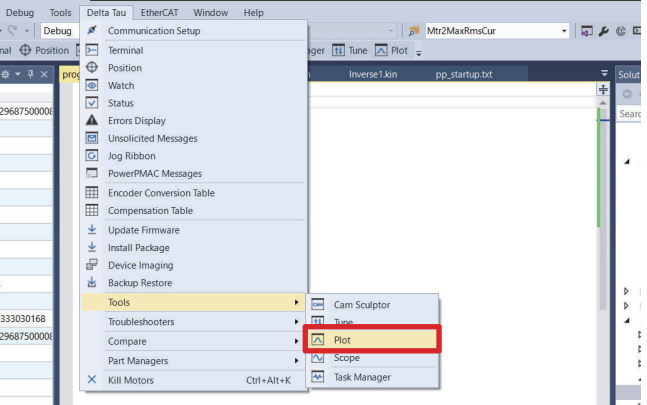
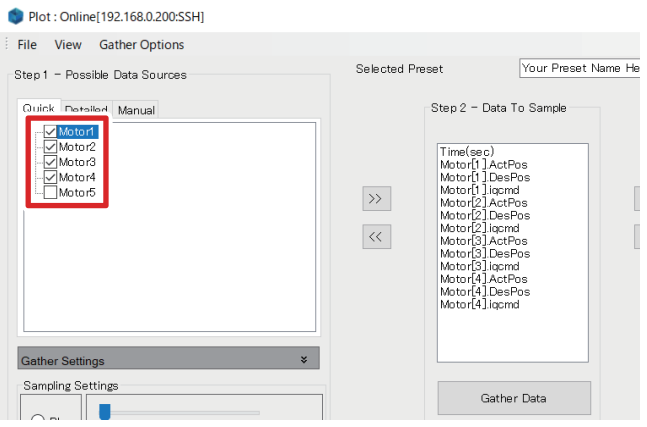

|                  |                                                                                                                                                                                                                                               |                                                                                      |
|------------------|-----------------------------------------------------------------------------------------------------------------------------------------------------------------------------------------------------------------------------------------------|--------------------------------------------------------------------------------------|
| <p><b>9</b></p>  | <p>Type the <b>save</b> command in the Power PMAC IDE Terminal.</p> <ul style="list-style-type: none"> <li>When the save is completed, "Save Completed" is displayed in the Terminal.</li> </ul>                                              |    |
| <p><b>10</b></p> | <p>Type the <b>\$\$\$</b> command in the Power PMAC IDE Terminal.</p>                                                                                                                                                                         |    |
| <p><b>11</b></p> | <p>Select <b>Tools – Plot</b> from the Delta Tau menu.</p>                                                                                                                                                                                    |   |
| <p><b>12</b></p> | <p>In the <b>Step1 – Possible Data Sources</b> area, select the check boxes for the following items.</p> <ul style="list-style-type: none"> <li><b>Motor1</b></li> <li><b>Motor2</b></li> <li><b>Motor3</b></li> <li><b>Motor4</b></li> </ul> |  |

**13** In the **Step3 – Data Processing** area, select the following items and click the **>>** button.

- **Motor[1] Cmd Position**
- **Motor[2] Cmd Position**
- **Motor[3] Cmd Position**
- **Motor[4] Cmd Position**

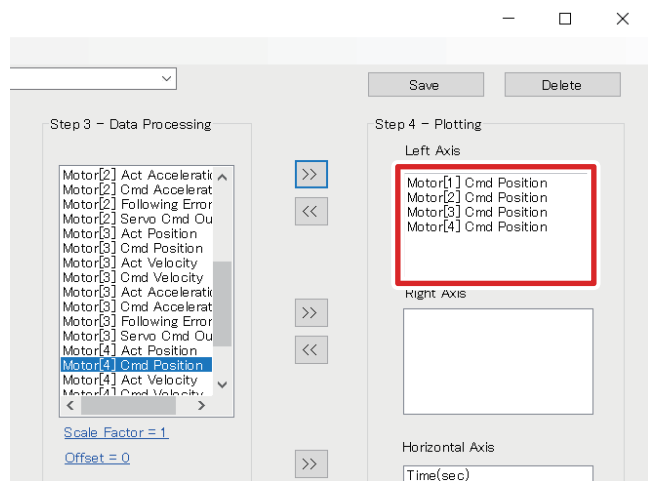
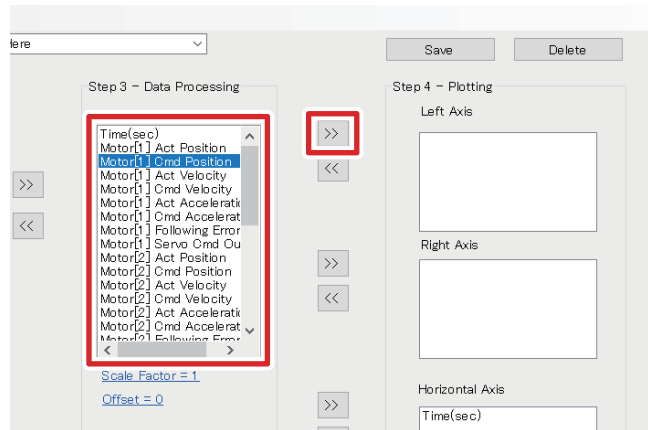

**14** Click the **Gather Data** button and type the **&1 enable** and the **&1 start 1** command in the Power PMAC IDE Terminal.

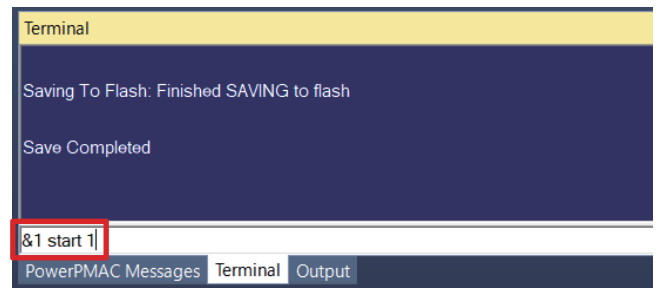
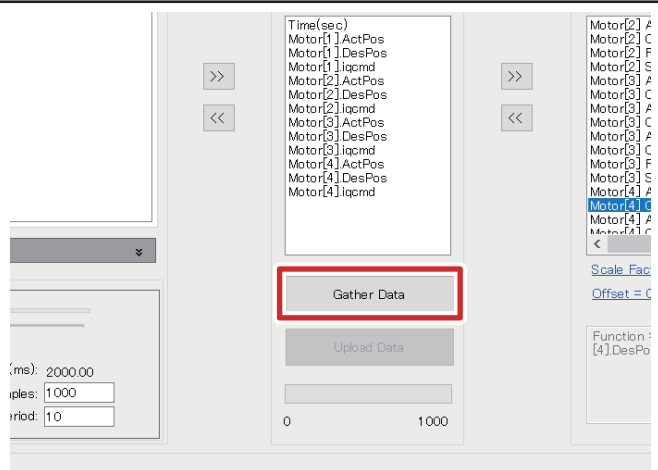

**15** Click the **Upload Data** button.

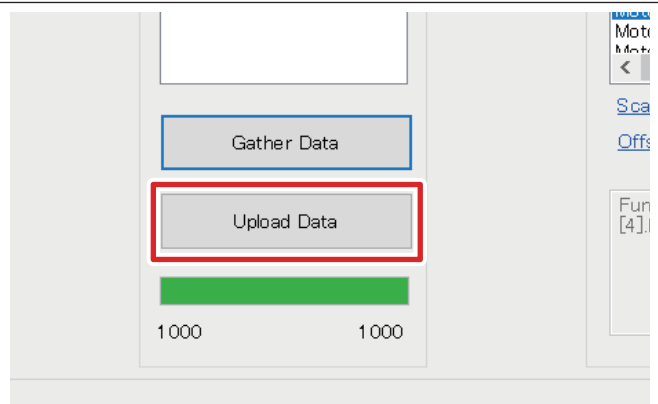

**16** Click the **Plot Data** button.

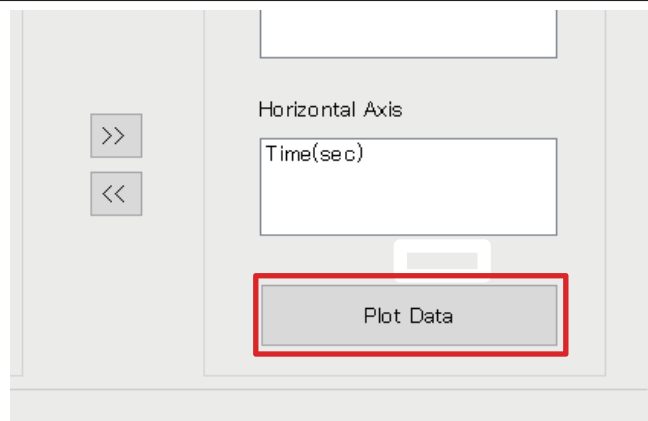

**17** Confirm that the position of each axis is displayed as shown on the right.

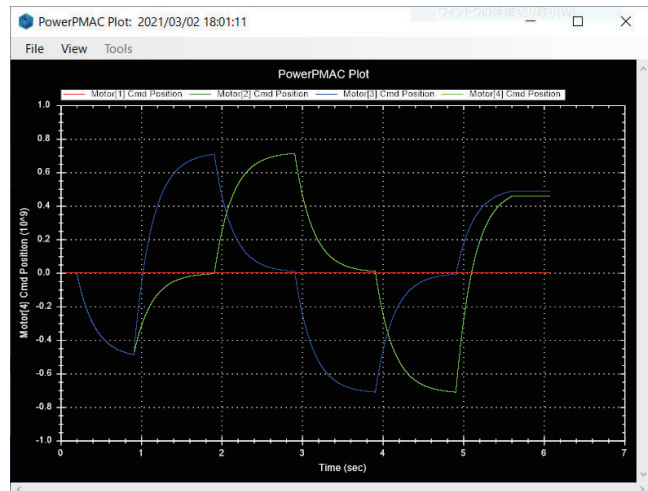

**18** If either Motor[3] Cmd Position or Motor[4] Cmd Position exceeds the maximum or the minimum command value of the Galvo Scanner, open the **global definitions.pmh** file and edit the KdgainX and KdgainY settings. Then, perform steps 7 to 17 again.

**19** If there is no problem with the filter response in step 18, right-click the **VirtualMotor.pmh** file in the Solution Explorer and select **Delete**.

## 3-4 Setup of the Motors and Encoder

### 3-4-1 Wiring Devices

The figures below show how to wire the CK3M to the Servo Drive and linear motors.

- Wiring of the X axis

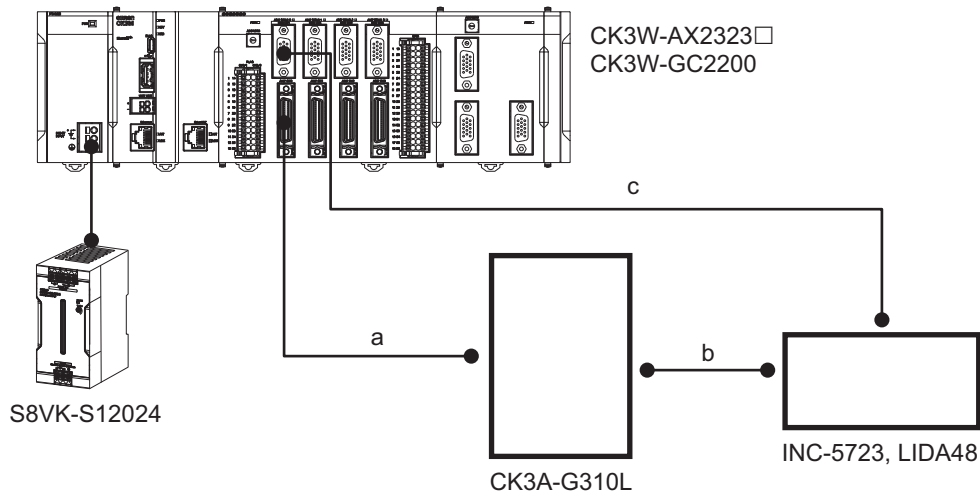

- Wiring of the Y axis

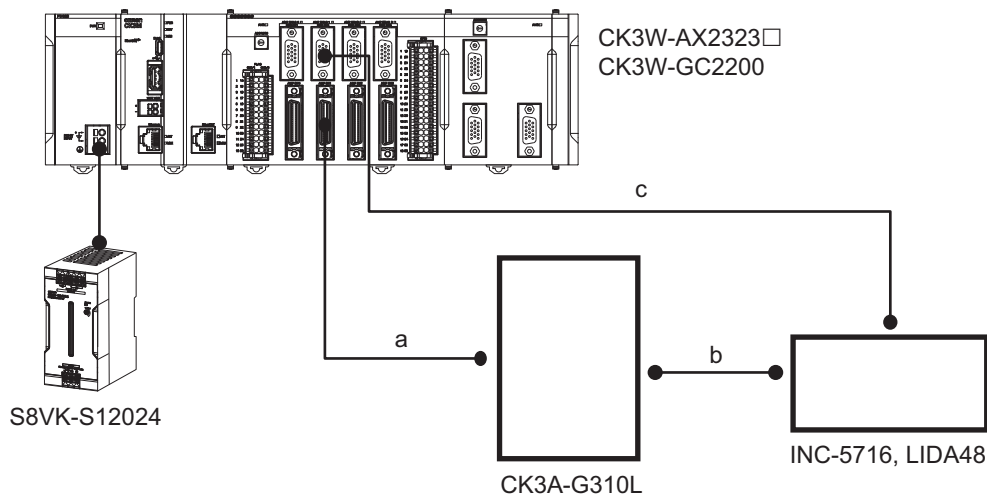

Connect the sections a, b, and c in the above figures as follows.

- Connection between the Controller and the servo amplifier  
Connect the amplifier connector of the CK3W-AX2323□ to the C2 connector of the servo amplifier with the following dedicated cable.

| Manufacturer | Name             | Model         | Length |
|--------------|------------------|---------------|--------|
| OMRON        | Direct PWM Cable | CK3W-CAAD009A | 0.9 m  |
|              |                  | CK3W-CAAD018A | 1.8 m  |
|              |                  | CK3W-CAAD036A | 3.6 m  |

- b. Connection between the servo amplifier and each servo motor  
Connect the motor connector of the linear motor to the P2 connector of the servo amplifier.
- c. Connection between the Controller and each servo motor  
Connect the encoder connector of the CK3W-AX2323 to the connector of the linear encoder with the dedicated cable CK3W-CAEA03A.

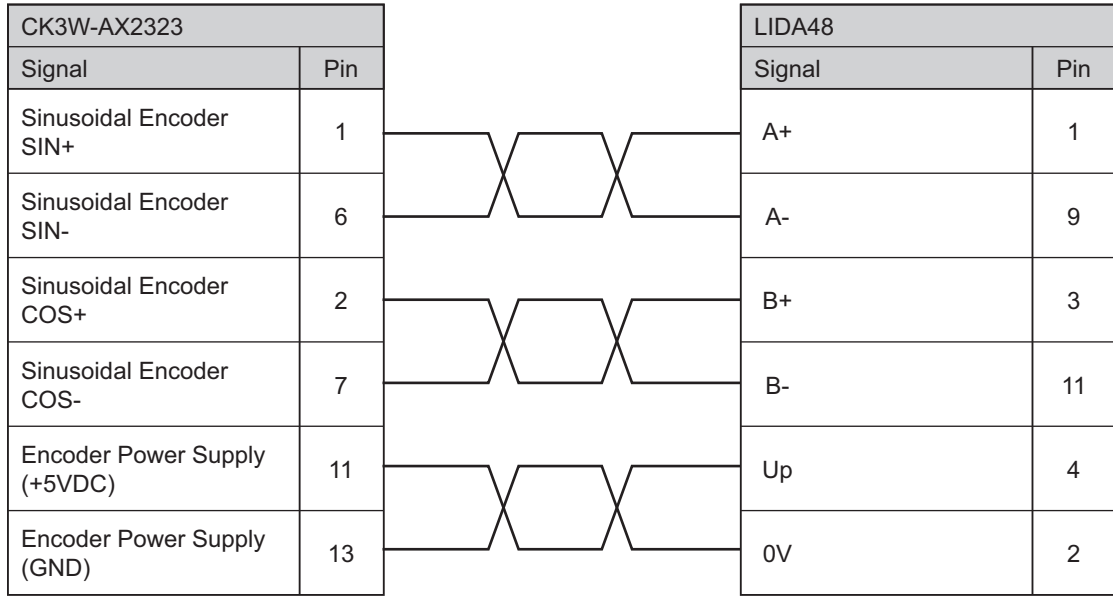

### 3-4-2 Programming

Program the settings for controlling the servo amplifier and the linear motor.

- 1 In the Solution Explorer, right-click **Global Includes** under **PMAC Script Language** and select **Add – New Item...**

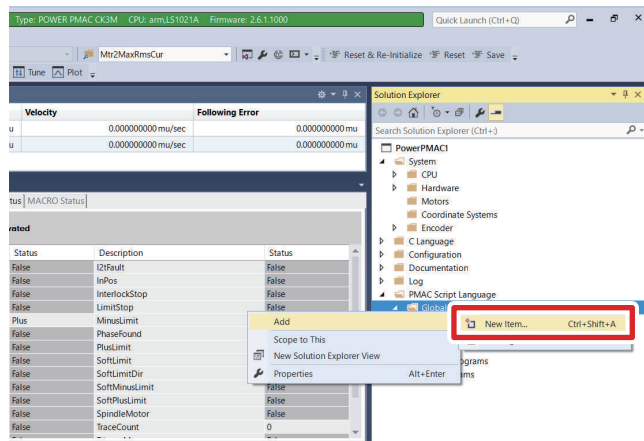

- 2** In the **Name** box, type *MotorControl.pmh* and click the **Add** button.

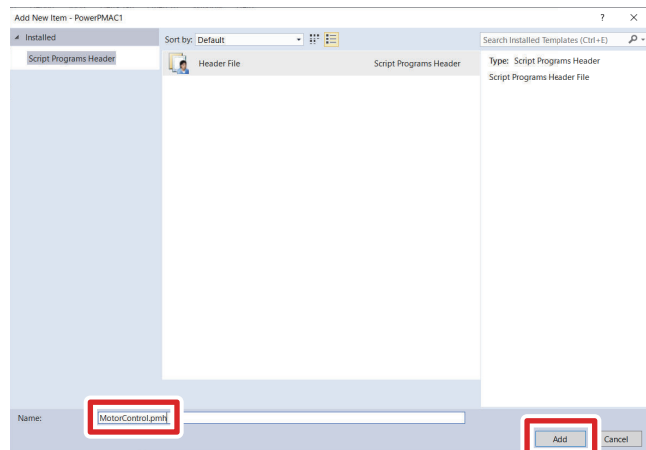

- 3** Open the **MotorControl.pmh** file under **PMAC Script Language – Global Includes** in the Solution Explorer.

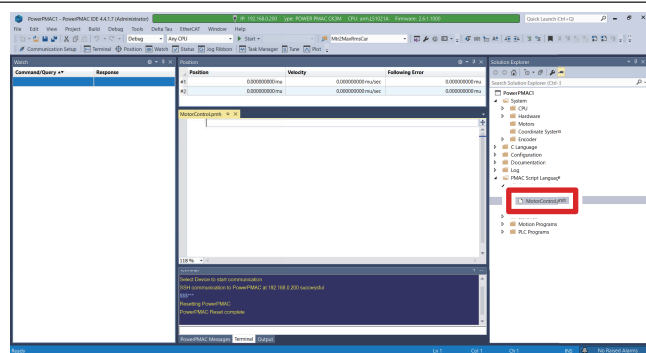

- 4** Write the following text to the MotorControl.pmh file.
- For details on the annotated settings, refer to *Section 4 How to Customize Various Settings* on page 4-1.

```

Sys.WpKey=$AAAAAAAA

//Servo Task Configurations
Motor[1].ServoCtrl=1 /*1
Motor[2].ServoCtrl=1 /*1
Motor[1].pEnc=EncTable[1].a /*2
Motor[2].pEnc=EncTable[2].a /*2
Motor[1].pEnc2=EncTable[1].a /*2
Motor[2].pEnc2=EncTable[2].a /*2
Motor[1].EncType=6 /*3
Motor[2].EncType=6 /*3
Motor[1].PosUnit=3 /*4
Motor[2].PosUnit=3 /*4
EncTable[1].Type=1 /*5
EncTable[2].Type=1 /*5
EncTable[1].pEnc=Gate3[0].Chan[0].ServoCapt.a /*6
EncTable[2].pEnc=Gate3[0].Chan[1].ServoCapt.a /*6
EncTable[1].ScaleFactor=1.0 /*7
EncTable[2].ScaleFactor=1.0 /*7
Motor[1].AmpFaultLevel=1 /*8
Motor[2].AmpFaultLevel=1 /*8
Motor[1].FatalFeLimit=5.0 /*9
Motor[2].FatalFeLimit=2.0 /*9

//Phase Task Configurations
Motor[1].PhaseCtrl=4; /*10
Motor[2].PhaseCtrl=4; /*10
Motor[1].pPhaseEnc=Gate3[0].Chan[0].PhaseCapt.a /*11
Motor[2].pPhaseEnc=Gate3[0].Chan[1].PhaseCapt.a /*11
Motor[1].PhasePosSf=2048*(0.020/16384)/36 /*12
Motor[2].PhasePosSf=2048*(0.020/16384)/36 /*12
Motor[1].PhaseOffset=683 /*13
Motor[2].PhaseOffset=683 /*13
Motor[1].pAdc=Gate3[0].Chan[0].AdcAmp[0].a /*14
Motor[2].pAdc=Gate3[0].Chan[1].AdcAmp[0].a /*14
Motor[1].AdcMask=$FFFF0000 /*15
Motor[2].AdcMask=$FFFF0000 /*15
Motor[1].pDac=Gate3[0].Chan[0].Pwm[0].a /*16
Motor[2].pDac=Gate3[0].Chan[1].Pwm[0].a /*16
Motor[1].PhaseFindingDac=Motor[1].I2tSet/2 /*17
Motor[2].PhaseFindingDac=Motor[2].I2tSet/2 /*17
Motor[1].PhaseFindingTime=3000/(2*Sys.ServoPeriod*(Sys.RtIntPeriod+1)) /*18
Motor[2].PhaseFindingTime=3000/(2*Sys.ServoPeriod*(Sys.RtIntPeriod+1)) /*18

```



```
//PWM Output Configurations
Motor[1].PwmSf=0.95*16384 // *19
Motor[2].PwmSf=0.95*16384 // *19
Motor[1].MaxDac=9.88*32768*COSD(30)/31.35 // *20
Motor[2].MaxDac=9.88*32768*COSD(30)/31.35 // *20
Motor[1].I2tSet=3.08*32768*COSD(30)/31.35 // *21
Motor[2].I2tSet=3.08*32768*COSD(30)/31.35 // *21
Motor[1].I2tTrip=(Motor[1].MaxDac*Motor[1].MaxDac-Motor[1].I2tSet*Motor[1].I2tSet)*
2 // *22
Motor[2].I2tTrip=(Motor[2].MaxDac*Motor[2].MaxDac-Motor[2].I2tSet*Motor[2].I2tSet)*
2 // *22
Gate3[0].Chan[0].PwmDeadTime=3 / 0.0533 // *23
Gate3[0].Chan[1].PwmDeadTime=3 / 0.0533 // *23
Gate3[0].Chan[0].PwmFreqMult=2 // *24
Gate3[0].Chan[1].PwmFreqMult=2 // *24
Gate3[0].Chan[0].PackOutData=0 // *25
Gate3[0].Chan[1].PackOutData=0 // *25

//Current Loop Configurations
Gate3[0].AdcAmpStrobe = $901001; // *26
Gate3[0].AdcAmpHeaderBits=4; // *27
Gate3[0].AdcAmpClockDiv=5; // *28
Gate3[0].AdcEncClockDiv=3 // *28
Gate3[0].Chan[0].PackInData=0 // *29
Gate3[0].Chan[1].PackInData=0 // *29

//Sinusoidal Encoder Settings
Gate3[0].Chan[0].AtanEna=1 // *30
Gate3[0].Chan[1].AtanEna=1 // *30
Gate3[0].Chan[0].EncCtrl=3 // *31
Gate3[0].Chan[1].EncCtrl=3 // *31
Motor[1].PosSf=0.020/16384 // *32
Motor[2].PosSf=0.020/16384 // *32
Motor[1].Pos2Sf=Motor[1].PosSf // *32
Motor[2].Pos2Sf=Motor[2].PosSf // *32
```

- 5** Right click on the Solution Explorer project name at the upper right of the Power PMAC IDE screen, select **Build and Download All Programs**, and execute Build and Download.

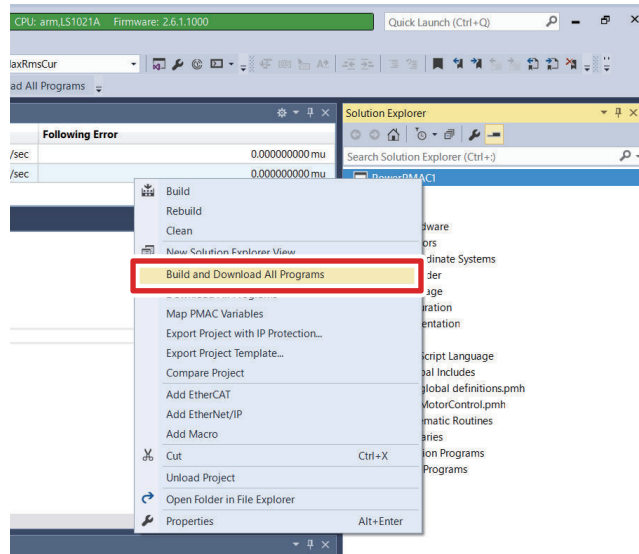

- 6** Make sure that there are no errors in the Output window.

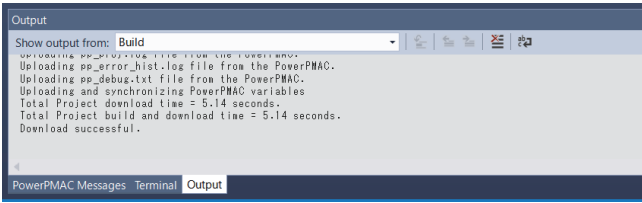
- 7** Type the **save** command in the Power PMAC IDE Terminal.

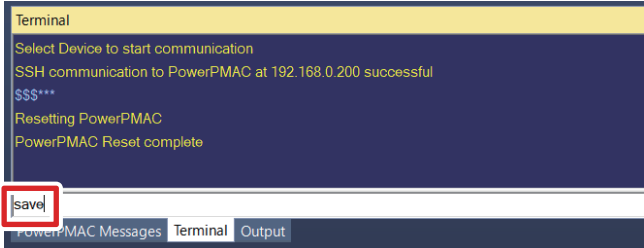

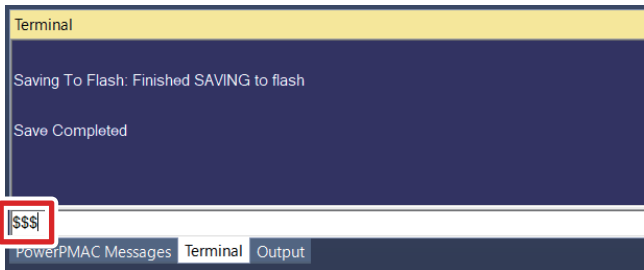
- 8** Type the **\$\$\$** command in the Power PMAC IDE Terminal.



### 3-4-3 Tuning of the Current Loop

Make the tuning of the current loop of the servo amplifier.

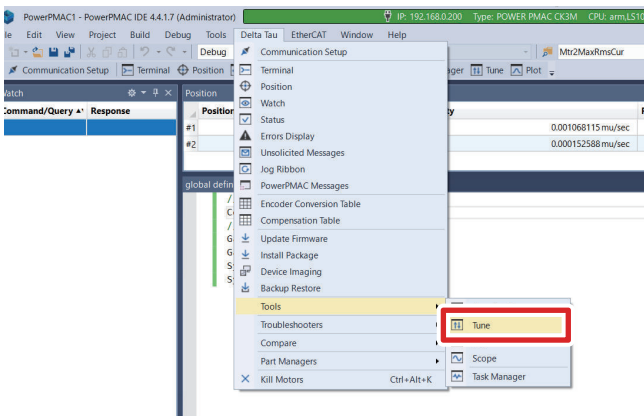
- 1** Select **Tools – Tune** from the **Delta Tau** menu to open the Tune screen.

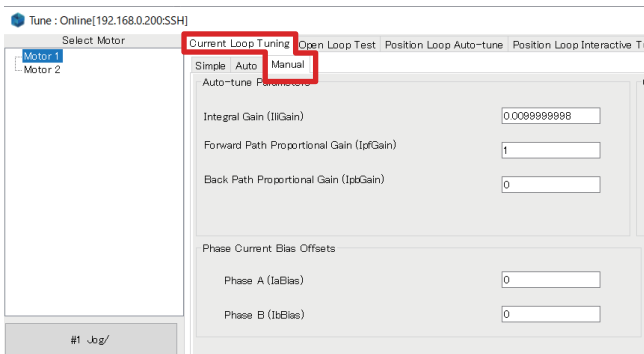

- 2** Select **Current Loop Tuning – Manual** tab page on the Tune screen.

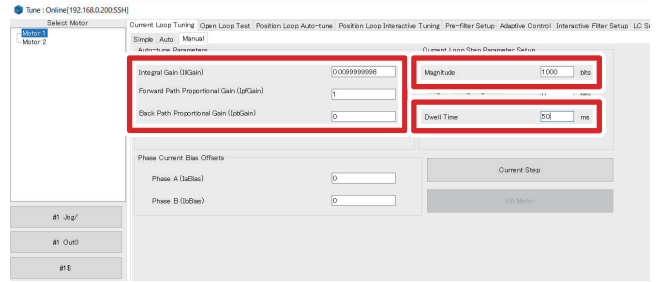

- 3** Set the following parameters.  
**IliGain:** 0.0099999998 (Default)  
**IpfGain:** 1 (Default)  
**IpbGain:** 0  
**Magnitude:** 1,000 bits  
**Dwell Time:** 50 ms

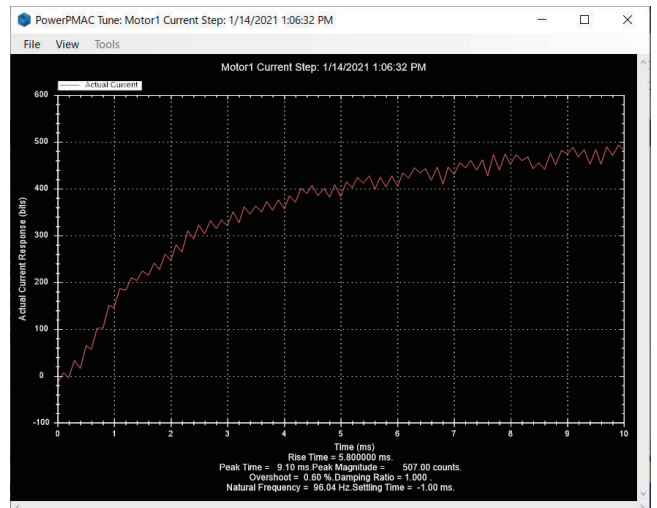
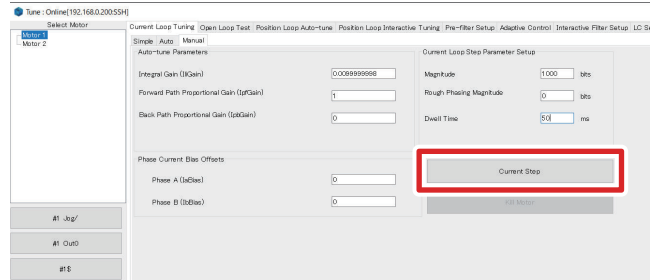

- 4** Click the **Current Step** button.
- The current step response is displayed.



**5** Adjust the **IliGain** and **IpfGain** values to obtain the desired response characteristics.

- If the rising edge response is slow, increase the **IliGain** value.
- If the amount of overshooting or oscillation is large, increase the **IpfGain** value.
- Gradually increase each of the gain values.

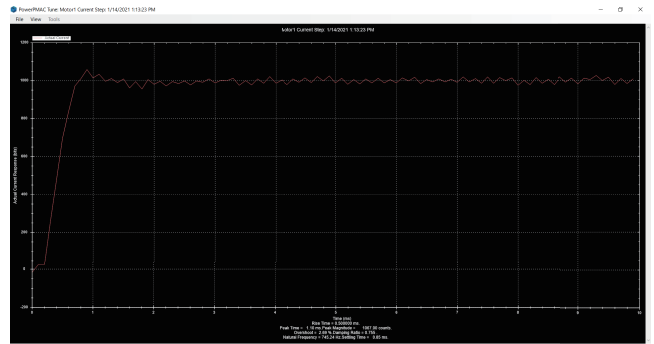
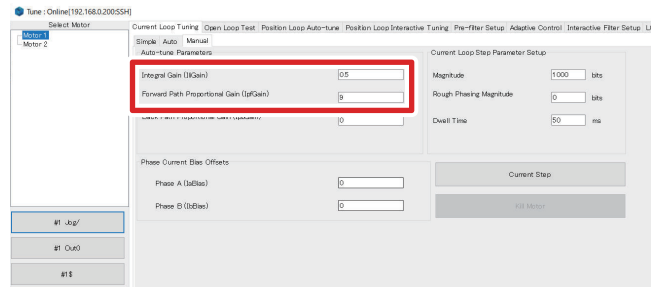

## 3-4-4 Establishment of the Phase Reference

Establish the phase reference of the linear motor.

**1** Type the **#1 out 0** command in the Power PMAC IDE Terminal.

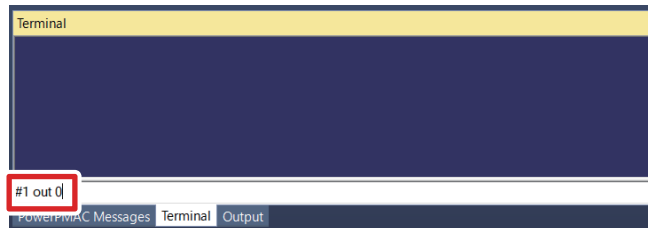



**2** Type the **Motor[1].IbBias=500** command in the Power PMAC IDE Terminal.

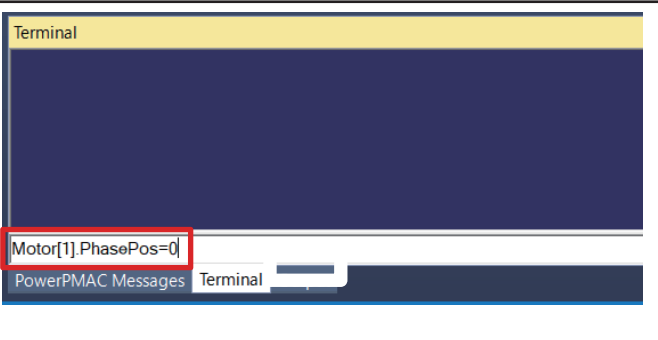

**3** Move the X axis manually to confirm that the servo is ON.

- If the servo is not ON, gradually increase the Motor[1].IbBias value.

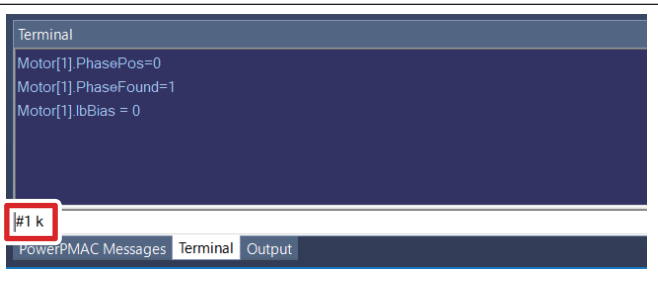
|   |                                                                               |                                                                                      |
|---|-------------------------------------------------------------------------------|--------------------------------------------------------------------------------------|
| 4 | Type the <b>Motor[1].PhasePos=0</b> command in the Power PMAC IDE Terminal.   |    |
| 5 | Type the <b>Motor[1].PhaseFound=1</b> command in the Power PMAC IDE Terminal. |    |
| 6 | Type the <b>Motor[1].IbBias=0</b> command in the Power PMAC IDE Terminal.     |   |
| 7 | Type the <b>#1 k</b> command in the Power PMAC IDE Terminal.                  |  |
| 8 | Perform steps 1 to 7 for Axis 2 (Y axis) in the same way.                     |                                                                                      |

### 3-4-5 Open-loop Testing

Operate the linear motor on the open loop system to confirm that the program is correct.

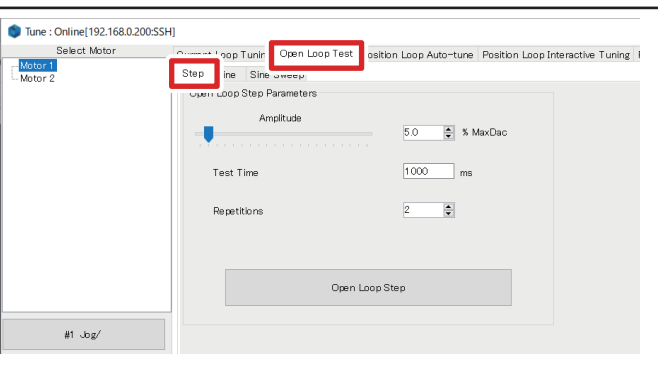
|   |                                                                                                                                        |                                                                                      |
|---|----------------------------------------------------------------------------------------------------------------------------------------|--------------------------------------------------------------------------------------|
| 1 | Select <b>Tools – Tune</b> from the <b>Delta Tau</b> menu to open the Tune screen. Then, select <b>Open Loop Test – Step</b> tab page. |  |
|---|----------------------------------------------------------------------------------------------------------------------------------------|--------------------------------------------------------------------------------------|

**2** Set the following tuning parameters.

**Amplitude:** 1.0%\*1  
**Test Time:** 1,000 ms  
**Repetitions:** 2

\*1. If the motor does not rotate, set a larger value.

**3** Click the **Open Loop Step** button.

- The motor makes a reciprocating motion, and then the test results as shown on the right are displayed.
- If the motor does not rotate, increase the **Test Amplitude** value.
- Here, the test results when **Test Amplitude** is set to 8.0% are shown.

### 3-4-6 Position Loop Auto-tuning

Perform the position loop auto-tuning in the linear motor.

**1** Select **Position Loop Auto-tune – Simple** tab page on the Tune screen.

**2** Set the following parameters.  
**Amplifier Type:** Direct PWM  
**Maximum:** 1 mu (1 mm)

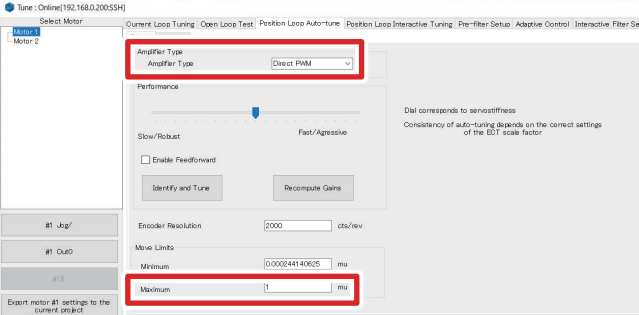

**3** Click the **Identify and Tune** button.

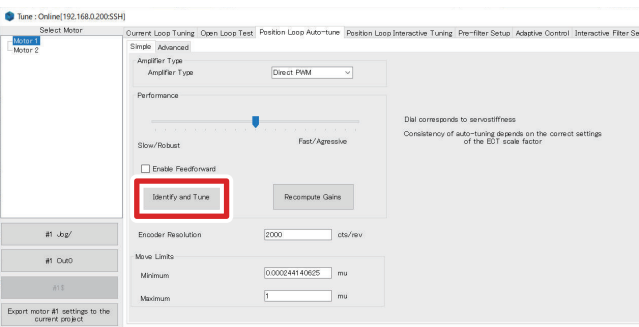

**4** When the screen on the right appears, click the **Implement** button.

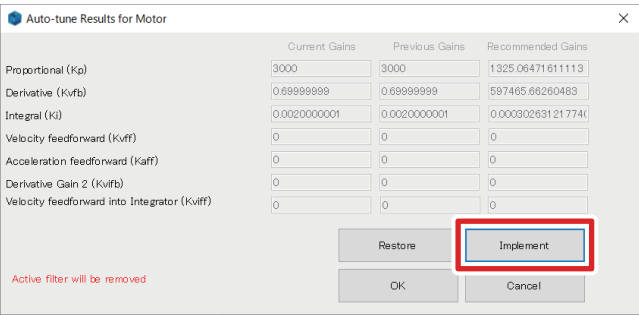

|                                              | Current Gains | Previous Gains | Recommended Gains |
|----------------------------------------------|---------------|----------------|-------------------|
| Proportional (Kp)                            | 3000          | 3000           | 1325.06471611113  |
| Derivative (Kvfb)                            | 0.69999999    | 0.69999999     | 597465.66260483   |
| Integral (Ki)                                | 0.0020000001  | 0.0020000001   | 0.00030263121774  |
| Velocity feedforward (Kvff)                  | 0             | 0              | 0                 |
| Acceleration feedforward (Kaff)              | 0             | 0              | 0                 |
| Derivative Gain 2 (Kvfb2)                    | 0             | 0              | 0                 |
| Velocity feedforward into Integrator (Kviff) | 0             | 0              | 0                 |

**5** Confirm that the **Current Gains** settings reflect the **Recommended Gains** values and click the **OK** button.

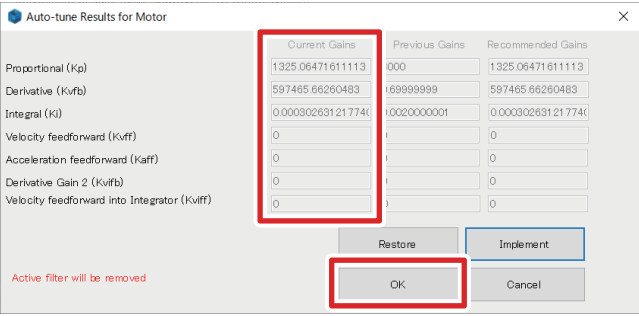

|                                              | Current Gains    | Previous Gains | Recommended Gains |
|----------------------------------------------|------------------|----------------|-------------------|
| Proportional (Kp)                            | 1325.06471611113 | 000            | 1325.06471611113  |
| Derivative (Kvfb)                            | 597465.66260483  | 0.69999999     | 597465.66260483   |
| Integral (Ki)                                | 0.00030263121774 | 0.0020000001   | 0.00030263121774  |
| Velocity feedforward (Kvff)                  | 0                | 0              | 0                 |
| Acceleration feedforward (Kaff)              | 0                | 0              | 0                 |
| Derivative Gain 2 (Kvfb2)                    | 0                | 0              | 0                 |
| Velocity feedforward into Integrator (Kviff) | 0                | 0              | 0                 |

### 3-4-7 Position Loop Interactive Tuning

Perform the position loop interactive tuning in the linear motor.

**1** Select **Position Loop Interactive Tuning** – **Step** tab page on the Tune screen.

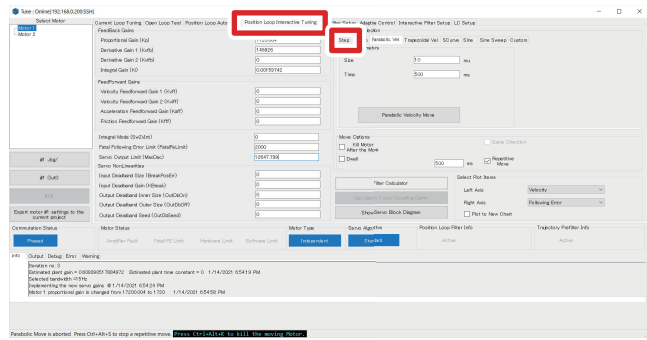

**2** Set the following parameters.

**FeedBack Gains**  
**Integral Gains (Ki): 0**

**Move Parameters**  
**Size: 10 mu**  
**Time: 1,000 ms**

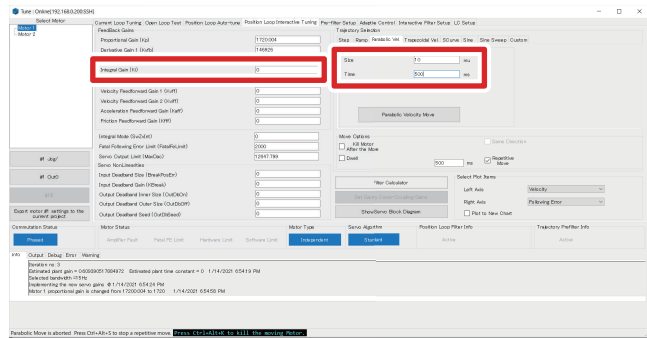

**3** Click the **Step Move** button.

**4** Check the step response characteristics.

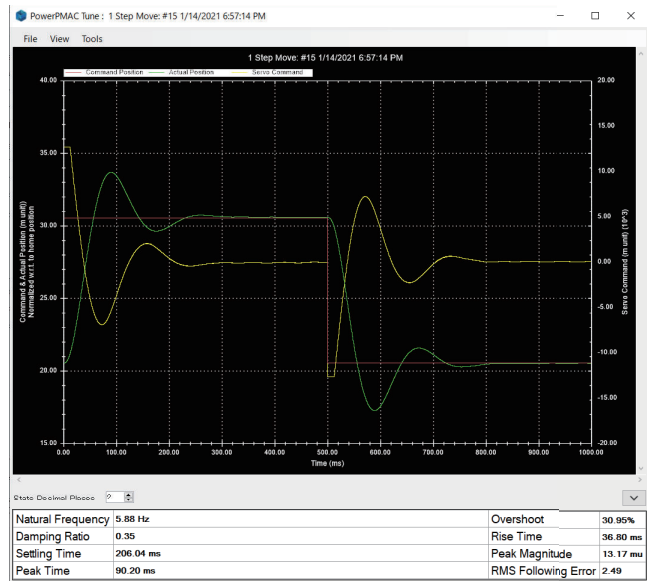



- 5** Adjust the **Proportional Gain (Kp)** and **Derivative Gain 1 (Kvfb)** values to obtain the desired response characteristics.
- If the rising edge response is slow, increase the **Proportional Gain (Kp)** value.
  - If the amount of overshooting or oscillation is large, increase the **Derivative Gain 1 (Kvfb)** value.
  - If the steady-state error is large, increase the **Integral Gain 1 (Ki)** value.
  - Gradually increase each of the gain values.
  - After you adjust each parameter, finish the tuning when the value of **Natural Frequency** has stopped increasing.

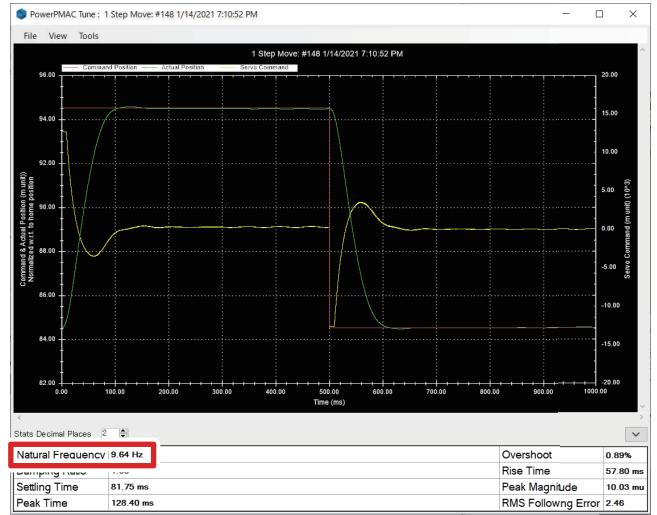

- 6** Select the **Parabolic Vel.** tab page and set the following parameters.
- Size:** 10 mu (10 mm)  
**Time:** 500 ms  
**Left Axis:** Velocity  
**Right Axis:** Following Error

- 7** Click the **Parabolic Velocity Move** button.

**8** Check the parabolic response characteristics of velocity.

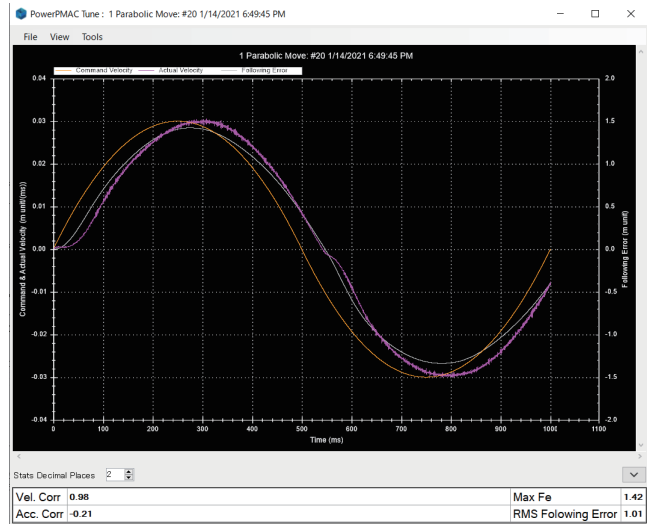

**9** If the **Following Error** has a positive correlation with the velocity, increase the **Kvff** value. If it has a negative correlation, decrease the **Kvff** value.

Command Velocity

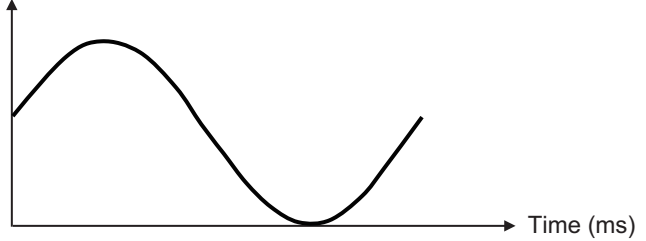

Following Error (positive correlation)

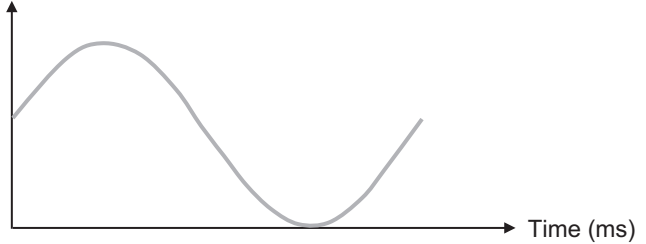

Following Error (negative correlation)

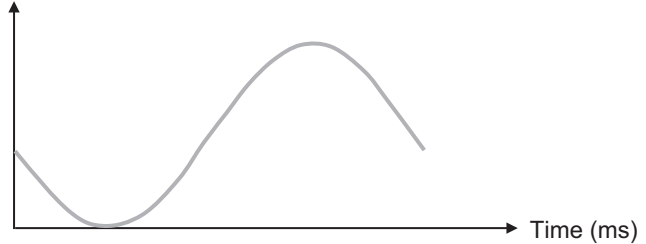

**10** Click the **Parabolic Velocity Move** button again.

- Repeat this operation until the **Following Error** is no longer correlated with the velocity.

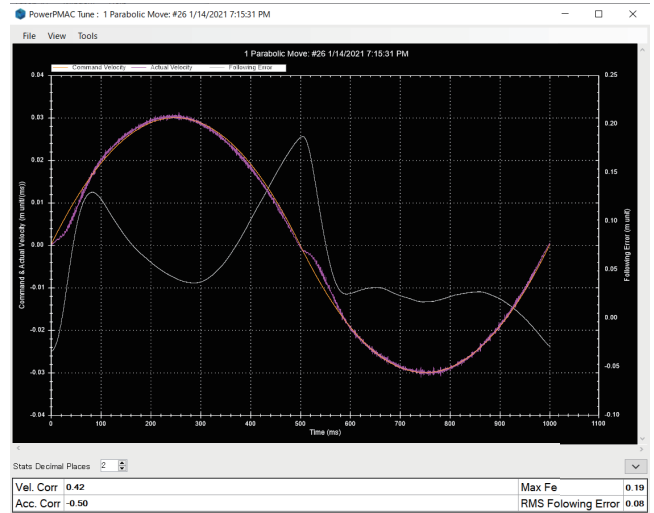

**11** Similarly, if the **Following Error** has a correlation with the **Acceleration** or friction, increase or decrease the **Kaff** or **Kfff** value.

Command Velocity

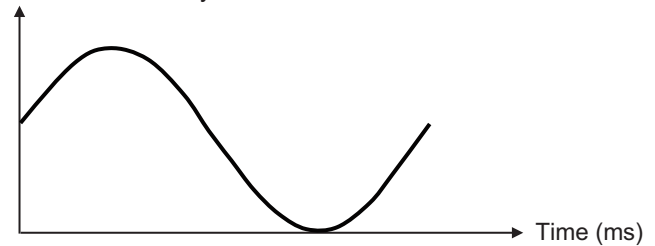

Following Error (positive correlation)

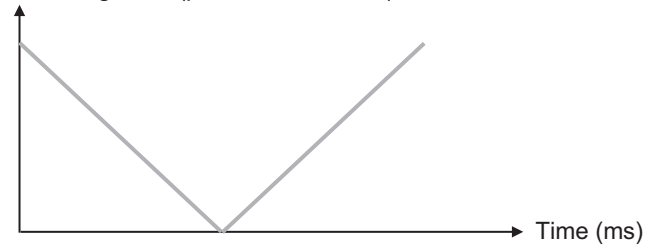

Following Error (negative correlation)

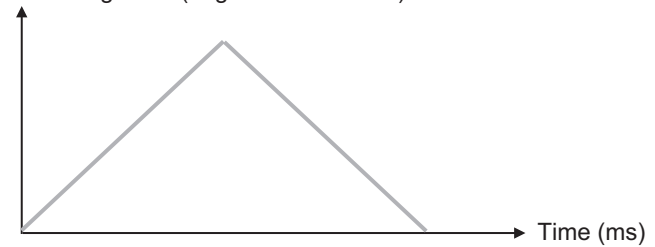

### 3-4-8 Tuning of the Y Axis

Make the tuning of the Y axis in the same way.

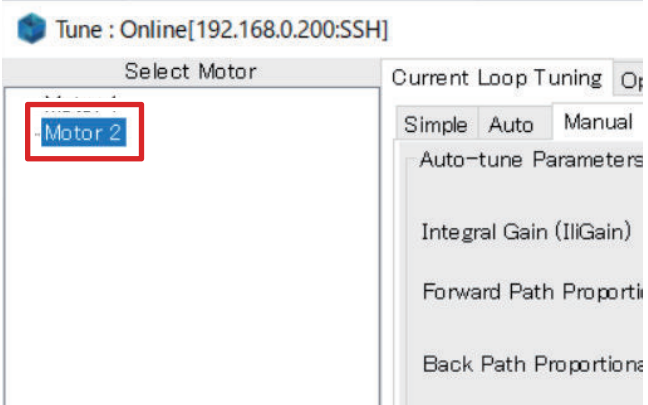
|          |                                                                                                                                  |                                                                                    |
|----------|----------------------------------------------------------------------------------------------------------------------------------|------------------------------------------------------------------------------------|
| <b>1</b> | Select <b>Motor2</b> in the <b>Select Motor</b> area of the Tuning screen.                                                       |  |
| <b>2</b> | Perform the current loop turning, open-loop testing, position loop auto-tuning, and position loop interactive tuning procedures. |                                                                                    |

### 3-4-9 Confirmation of the Tuning Results

Confirm that the tuning results are correct, and reflect them in the project file.

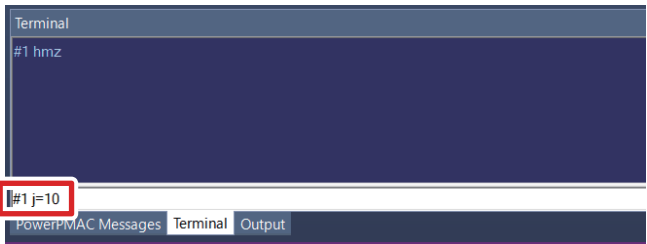
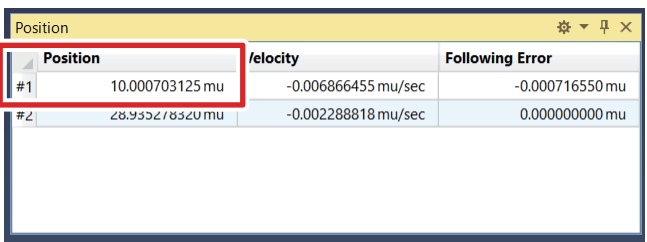
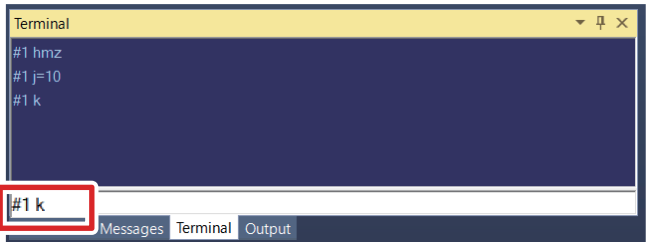
| <b>1</b> | Type the <b>#1 hmz</b> command in the Power PMAC IDE Terminal. After that, type the <b>#1 j=10</b> command.              |                                                                                                                                                                                                                                                                                                                                                                                         |                 |          |          |                 |    |                 |                     |                 |    |                 |                     |                |
|----------|--------------------------------------------------------------------------------------------------------------------------|----------------------------------------------------------------------------------------------------------------------------------------------------------------------------------------------------------------------------------------------------------------------------------------------------------------------------------------------------------------------------------------------------------------------------------------------------------------------------|-----------------|----------|----------|-----------------|----|-----------------|---------------------|-----------------|----|-----------------|---------------------|----------------|
| <b>2</b> | Confirm that the X axis is moving. Also, confirm that the value of <b>Position #1</b> is around 10.0 in Position window. |  <table border="1" style="margin-left: 20px;"> <thead> <tr> <th></th> <th>Position</th> <th>Velocity</th> <th>Following Error</th> </tr> </thead> <tbody> <tr> <td>#1</td> <td>10.000703125 mu</td> <td>-0.006866455 mu/sec</td> <td>-0.000716550 mu</td> </tr> <tr> <td>#2</td> <td>28.955278520 mu</td> <td>-0.002288818 mu/sec</td> <td>0.000000000 mu</td> </tr> </tbody> </table> |                 | Position | Velocity | Following Error | #1 | 10.000703125 mu | -0.006866455 mu/sec | -0.000716550 mu | #2 | 28.955278520 mu | -0.002288818 mu/sec | 0.000000000 mu |
|          | Position                                                                                                                 | Velocity                                                                                                                                                                                                                                                                                                                                                                                                                                                                   | Following Error |          |          |                 |    |                 |                     |                 |    |                 |                     |                |
| #1       | 10.000703125 mu                                                                                                          | -0.006866455 mu/sec                                                                                                                                                                                                                                                                                                                                                                                                                                                        | -0.000716550 mu |          |          |                 |    |                 |                     |                 |    |                 |                     |                |
| #2       | 28.955278520 mu                                                                                                          | -0.002288818 mu/sec                                                                                                                                                                                                                                                                                                                                                                                                                                                        | 0.000000000 mu  |          |          |                 |    |                 |                     |                 |    |                 |                     |                |
| <b>3</b> | Type the <b>#1 k</b> command in the Power PMAC IDE Terminal to stop the motor.                                           |                                                                                                                                                                                                                                                                                                                                                                                        |                 |          |          |                 |    |                 |                     |                 |    |                 |                     |                |
| <b>4</b> | Perform steps 1 to 3 for Motor[2] as well.                                                                               |                                                                                                                                                                                                                                                                                                                                                                                                                                                                            |                 |          |          |                 |    |                 |                     |                 |    |                 |                     |                |
| <b>5</b> | Open the <b>MotorControl.pmh</b> file under <b>PMAC Script Language – Global Includes</b> in the Solution Explorer.      |                                                                                                                                                                                                                                                                                                                                                                                                                                                                            |                 |          |          |                 |    |                 |                     |                 |    |                 |                     |                |

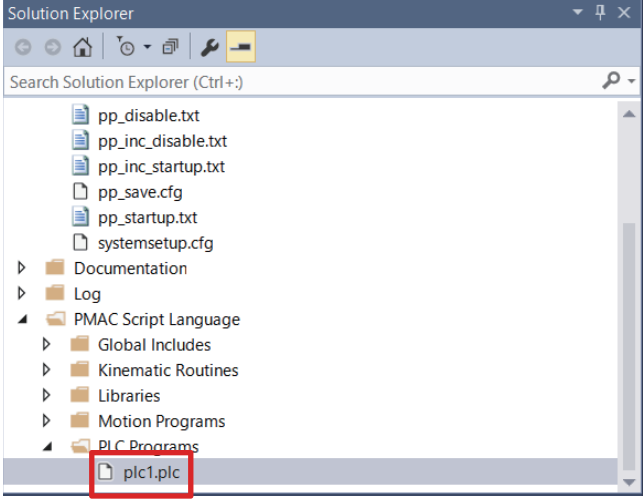
|    |                                                                                                          |                                                                                                                                                                                                                                                                                                                                        |
|----|----------------------------------------------------------------------------------------------------------|----------------------------------------------------------------------------------------------------------------------------------------------------------------------------------------------------------------------------------------------------------------------------------------------------------------------------------------|
| 6  | Add the gain settings obtained from the tuning to the MotorControl.pmh file.                             | <pre> Motor[1].IiGain=*** Motor[2].IiGain=*** Motor[1].IpfGain=*** Motor[2].IpfGain=*** Motor[1].Servo.Kp=*** Motor[2].Servo.Kp=*** Motor[1].Servo.Kvfb=*** Motor[2].Servo.Kvfb=*** Motor[1].Servo.Ki=*** Motor[2].Servo.Ki=*** Motor[1].Servo.Kaff=*** Motor[2].Servo.Kaff=*** Motor[1].Servo.Kvff=*** Motor[1].Servo.Kfff=*** </pre> |
| 7  | Open the <b>pp_startup.txt</b> file under <b>Configuration</b> in the Solution Explorer.                 |                                                                                                                                                                                                                                                                                                                                        |
| 8  | Write the phase search commands shown on the right.                                                      | <pre>enable plc PhaseSearch</pre>                                                                                                                                                                                                                                                                                                      |
| 9  | Open the <b>plc1.plc</b> file under <b>PMAC Script Language – PLC Programs</b> in the Solution Explorer. |                                                                                                                                                                                                                                                     |
| 10 | Add the program shown on the right to the plc1.plc file.                                                 | <pre> open plc PhaseSearch  P0=Sys.Time+1.0; while (P0&gt;Sys.Time) {}; Motor[1].PhaseFindingStep=1; while (Motor[1].PhaseFindingStep!=0) {}; Motor[2].PhaseFindingStep=1; while (Motor[2].PhaseFindingStep!=0) {};  disable plc PhaseSearch  close </pre>                                                                             |

- 
- 11** Right click on the Solution Explorer project name at the upper right of the Power PMAC IDE screen, select **Build and Download All Programs**, and execute Build and Download.
- You can download the gain settings to the PMAC as a program by writing them in the MotorControl.pmh file as shown in steps 5 and 6.
  - With the phase search commands written in pp\_startup.txt as shown in steps 7 and 8, phase search is performed automatically after the power supply is turned ON or the CPU Unit is reset to enable Motor[1] and Motor[2].
-

## 3-5 Setup of Overtravel Limit Switches and Home Positions

### 3-5-1 Wiring of Devices

The figures below show how to wire the CK3M to various sensors.

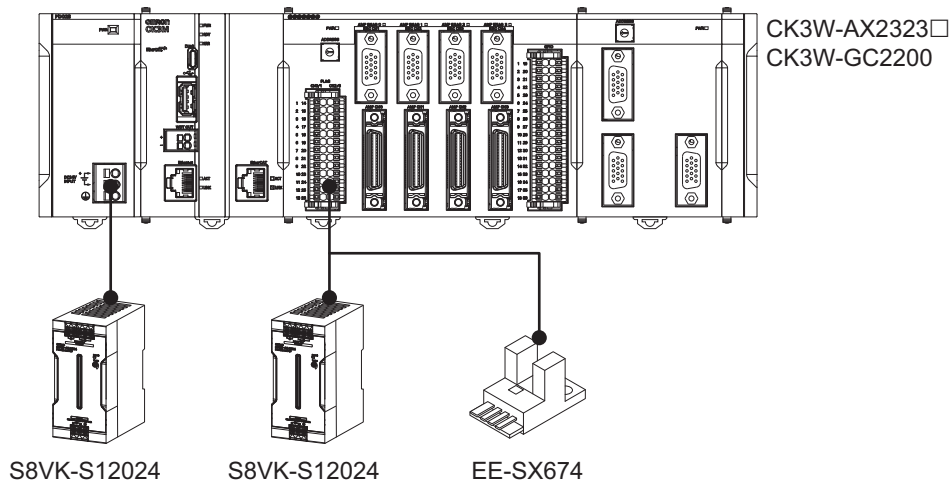

Connect the EE-SX674 to the following FLAG terminals of the CK3W-AX2323N.

- PLIM0: X-axis positive overtravel limit switch
- NLIM0: X-axis negative overtravel limit switch
- PLIM1: Y-axis positive overtravel limit switch
- NLIM1: Y-axis negative overtravel limit switch

The following shows an example of wiring to the HOME0 terminal.

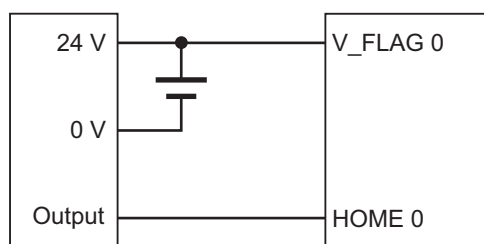

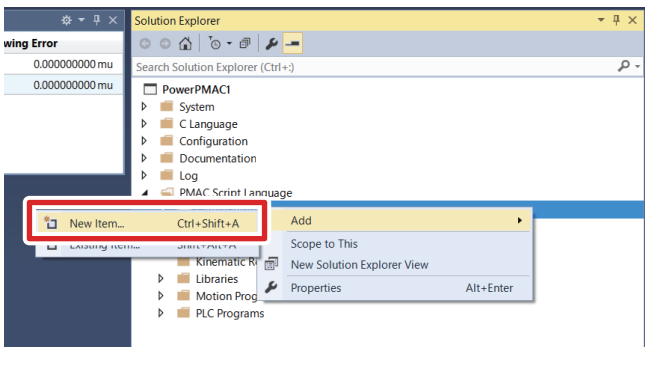
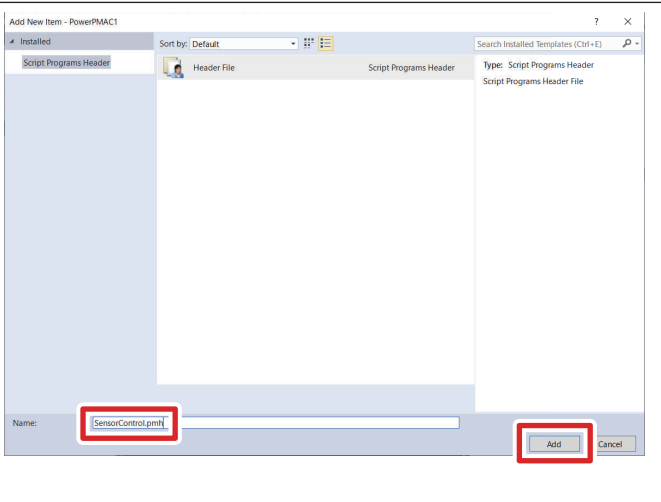
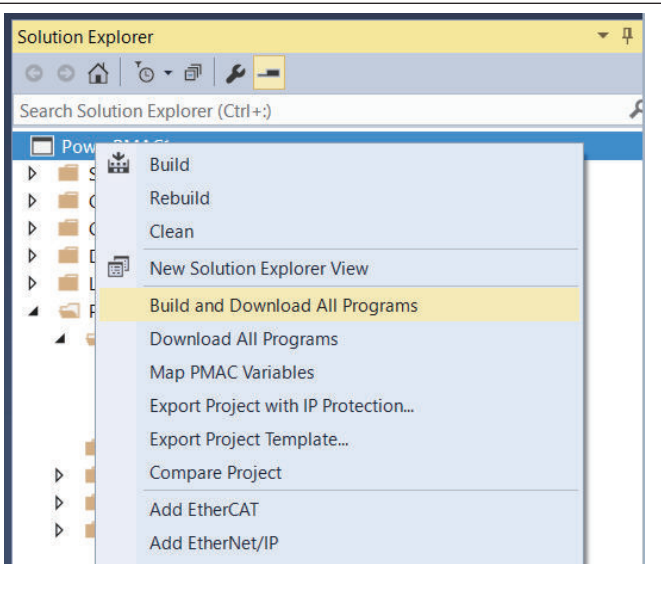

### 3-5-2 Programming

Set up the overtravel limit switches.

|                 |                                                                                                                                                                                                                                                  |                                                                                                                                                                                                                                |
|-----------------|--------------------------------------------------------------------------------------------------------------------------------------------------------------------------------------------------------------------------------------------------|--------------------------------------------------------------------------------------------------------------------------------------------------------------------------------------------------------------------------------|
| <p><b>1</b></p> | <p>In the Solution Explorer, right-click <b>Global Includes</b> under <b>PMAC Script Language</b> and select <b>Add – New Item....</b></p>                                                                                                       |                                                                                                                                              |
| <p><b>2</b></p> | <p>In the <b>Name</b> box, type <i>SensorControl.pmh</i> and click the <b>Add</b> button.</p>                                                                                                                                                    |                                                                                                                                             |
| <p><b>3</b></p> | <p>Open the <b>SensorControl.pmh</b> file under <b>PMAC Script Language – Global Includes</b> in the Solution Explorer.</p>                                                                                                                      |                                                                                                                                                                                                                                |
| <p><b>4</b></p> | <p>Write the text shown on the right to the <b>SensorControl.pmh</b> file.</p> <ul style="list-style-type: none"> <li>For details on the annotated settings, refer to <i>Section 4 How to Customize Various Settings</i> on page 4-1.</li> </ul> | <pre>Sys.WpKey=\$AAAAAAAA //Overtravel Limit Switch Configurations Motor[1].pLimits=Gate3[0].Chan[0].Status.a;// *1 Motor[2].pLimits=Gate3[0].Chan[1].Status.a;// *1 Motor[1].LimitBits=9;//*2 Motor[2].LimitBits=9;//*2</pre> |
| <p><b>5</b></p> | <p>Right click on the Solution Explorer project name at the upper right of the Power PMAC IDE screen, select <b>Build and Download All Programs</b>, and execute Build and Download.</p>                                                         |                                                                                                                                            |

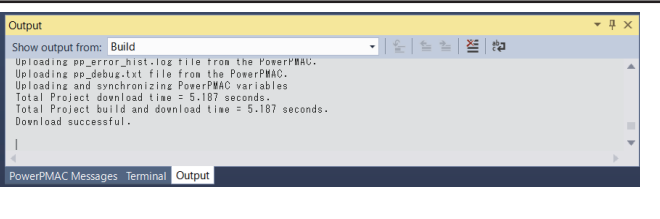

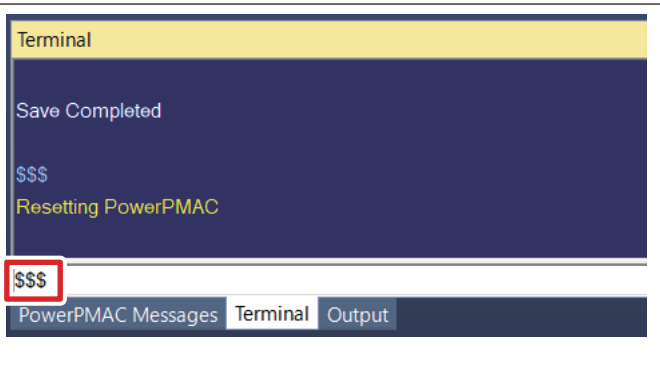
|                 |                                                                       |                                                                                     |
|-----------------|-----------------------------------------------------------------------|-------------------------------------------------------------------------------------|
| <p><b>6</b></p> | <p>Make sure that there are no errors in the Output window.</p>       |   |
| <p><b>7</b></p> | <p>Type the <b>save</b> command in the Power PMAC IDE Terminal.</p>   |   |
| <p><b>8</b></p> | <p>Type the <b>\$\$\$</b> command in the Power PMAC IDE Terminal.</p> |  |

### 3-5-3 Confirmation of the Settings (Overtravel Limit Switches)

Confirm that the settings of overtravel limit switches operate correctly.

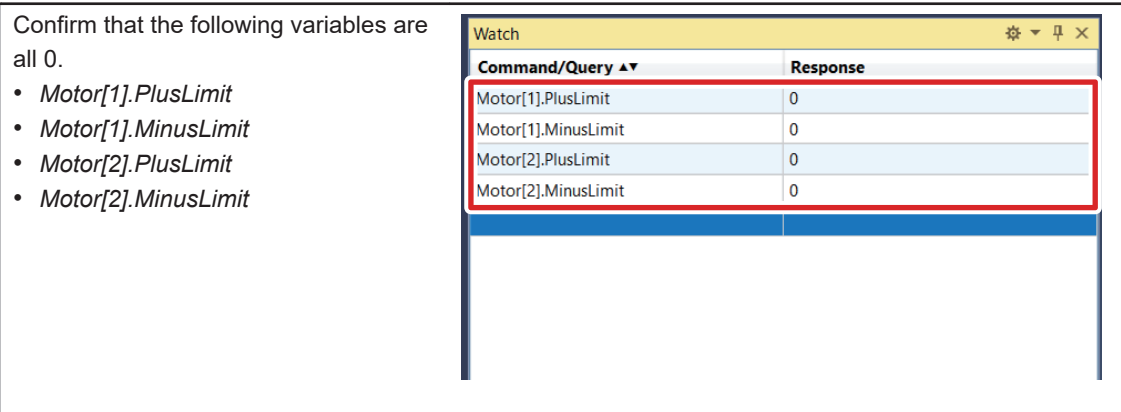
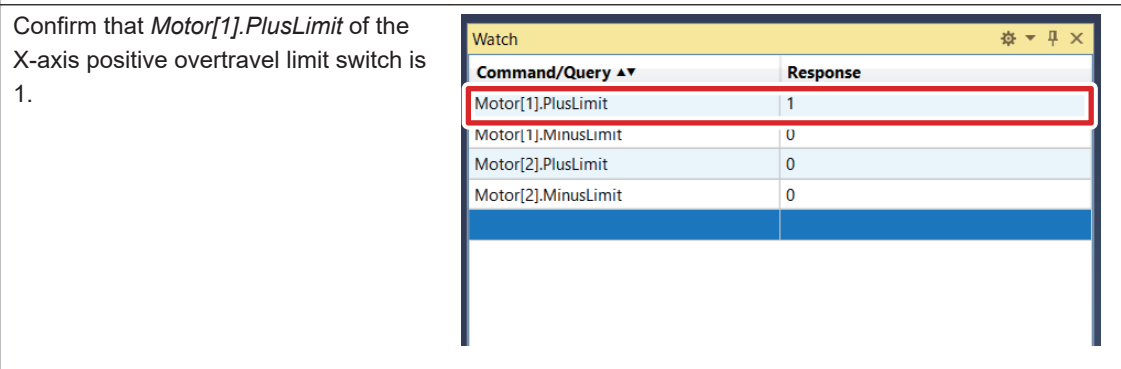
| <p><b>1</b></p> <p>Confirm that the following variables are all 0.</p> <ul style="list-style-type: none"> <li>• <i>Motor[1].PlusLimit</i></li> <li>• <i>Motor[1].MinusLimit</i></li> <li>• <i>Motor[2].PlusLimit</i></li> <li>• <i>Motor[2].MinusLimit</i></li> </ul> |  <table border="1"> <thead> <tr> <th>Command/Query</th> <th>Response</th> </tr> </thead> <tbody> <tr> <td>Motor[1].PlusLimit</td> <td>0</td> </tr> <tr> <td>Motor[1].MinusLimit</td> <td>0</td> </tr> <tr> <td>Motor[2].PlusLimit</td> <td>0</td> </tr> <tr> <td>Motor[2].MinusLimit</td> <td>0</td> </tr> </tbody> </table> | Command/Query | Response | Motor[1].PlusLimit | 0 | Motor[1].MinusLimit | 0 | Motor[2].PlusLimit | 0 | Motor[2].MinusLimit | 0 |
|-----------------------------------------------------------------------------------------------------------------------------------------------------------------------------------------------------------------------------------------------------------------------|------------------------------------------------------------------------------------------------------------------------------------------------------------------------------------------------------------------------------------------------------------------------------------------------------------------------------------------------------------------------------------------------------------------|---------------|----------|--------------------|---|---------------------|---|--------------------|---|---------------------|---|
| Command/Query                                                                                                                                                                                                                                                         | Response                                                                                                                                                                                                                                                                                                                                                                                                         |               |          |                    |   |                     |   |                    |   |                     |   |
| Motor[1].PlusLimit                                                                                                                                                                                                                                                    | 0                                                                                                                                                                                                                                                                                                                                                                                                                |               |          |                    |   |                     |   |                    |   |                     |   |
| Motor[1].MinusLimit                                                                                                                                                                                                                                                   | 0                                                                                                                                                                                                                                                                                                                                                                                                                |               |          |                    |   |                     |   |                    |   |                     |   |
| Motor[2].PlusLimit                                                                                                                                                                                                                                                    | 0                                                                                                                                                                                                                                                                                                                                                                                                                |               |          |                    |   |                     |   |                    |   |                     |   |
| Motor[2].MinusLimit                                                                                                                                                                                                                                                   | 0                                                                                                                                                                                                                                                                                                                                                                                                                |               |          |                    |   |                     |   |                    |   |                     |   |
| <p><b>2</b></p> <p>Confirm that <i>Motor[1].PlusLimit</i> of the X-axis positive overtravel limit switch is 1.</p>                                                                                                                                                    |  <table border="1"> <thead> <tr> <th>Command/Query</th> <th>Response</th> </tr> </thead> <tbody> <tr> <td>Motor[1].PlusLimit</td> <td>1</td> </tr> <tr> <td>Motor[1].MinusLimit</td> <td>0</td> </tr> <tr> <td>Motor[2].PlusLimit</td> <td>0</td> </tr> <tr> <td>Motor[2].MinusLimit</td> <td>0</td> </tr> </tbody> </table> | Command/Query | Response | Motor[1].PlusLimit | 1 | Motor[1].MinusLimit | 0 | Motor[2].PlusLimit | 0 | Motor[2].MinusLimit | 0 |
| Command/Query                                                                                                                                                                                                                                                         | Response                                                                                                                                                                                                                                                                                                                                                                                                         |               |          |                    |   |                     |   |                    |   |                     |   |
| Motor[1].PlusLimit                                                                                                                                                                                                                                                    | 1                                                                                                                                                                                                                                                                                                                                                                                                                |               |          |                    |   |                     |   |                    |   |                     |   |
| Motor[1].MinusLimit                                                                                                                                                                                                                                                   | 0                                                                                                                                                                                                                                                                                                                                                                                                                |               |          |                    |   |                     |   |                    |   |                     |   |
| Motor[2].PlusLimit                                                                                                                                                                                                                                                    | 0                                                                                                                                                                                                                                                                                                                                                                                                                |               |          |                    |   |                     |   |                    |   |                     |   |
| Motor[2].MinusLimit                                                                                                                                                                                                                                                   | 0                                                                                                                                                                                                                                                                                                                                                                                                                |               |          |                    |   |                     |   |                    |   |                     |   |

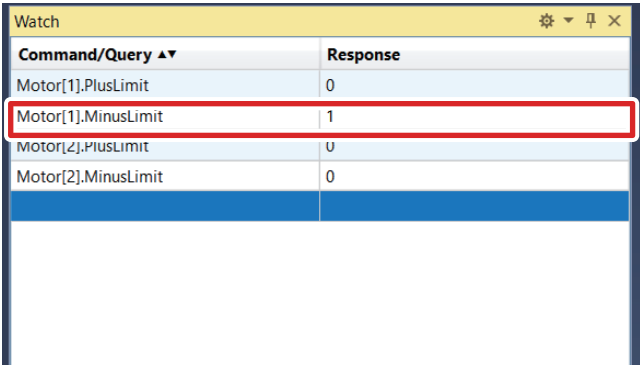
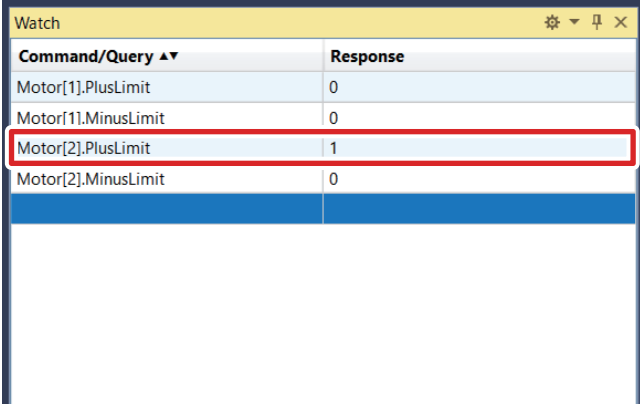
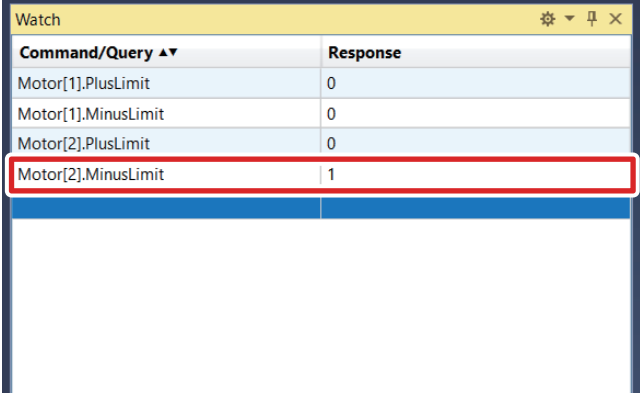
| <p><b>3</b> Confirm that <i>Motor[1].MinusLimit</i> of the X-axis negative overtravel limit switch is 1.</p> |  <table border="1" style="width: 100%; border-collapse: collapse;"> <thead> <tr> <th style="text-align: left;">Command/Query ▲▼</th> <th style="text-align: left;">Response</th> </tr> </thead> <tbody> <tr> <td>Motor[1].PlusLimit</td> <td>0</td> </tr> <tr style="border: 2px solid red;"> <td>Motor[1].MinusLimit</td> <td>1</td> </tr> <tr> <td>Motor[2].PlusLimit</td> <td>0</td> </tr> <tr> <td>Motor[2].MinusLimit</td> <td>0</td> </tr> </tbody> </table>   | Command/Query ▲▼ | Response | Motor[1].PlusLimit | 0 | Motor[1].MinusLimit | 1 | Motor[2].PlusLimit | 0 | Motor[2].MinusLimit | 0 |
|--------------------------------------------------------------------------------------------------------------|--------------------------------------------------------------------------------------------------------------------------------------------------------------------------------------------------------------------------------------------------------------------------------------------------------------------------------------------------------------------------------------------------------------------------------------------------------------------------------------------------------------------------------------------------------|------------------|----------|--------------------|---|---------------------|---|--------------------|---|---------------------|---|
| Command/Query ▲▼                                                                                             | Response                                                                                                                                                                                                                                                                                                                                                                                                                                                                                                                                               |                  |          |                    |   |                     |   |                    |   |                     |   |
| Motor[1].PlusLimit                                                                                           | 0                                                                                                                                                                                                                                                                                                                                                                                                                                                                                                                                                      |                  |          |                    |   |                     |   |                    |   |                     |   |
| Motor[1].MinusLimit                                                                                          | 1                                                                                                                                                                                                                                                                                                                                                                                                                                                                                                                                                      |                  |          |                    |   |                     |   |                    |   |                     |   |
| Motor[2].PlusLimit                                                                                           | 0                                                                                                                                                                                                                                                                                                                                                                                                                                                                                                                                                      |                  |          |                    |   |                     |   |                    |   |                     |   |
| Motor[2].MinusLimit                                                                                          | 0                                                                                                                                                                                                                                                                                                                                                                                                                                                                                                                                                      |                  |          |                    |   |                     |   |                    |   |                     |   |
| <p><b>4</b> Confirm that <i>Motor[2].PlusLimit</i> of the Y-axis positive overtravel limit switch is 1.</p>  |  <table border="1" style="width: 100%; border-collapse: collapse;"> <thead> <tr> <th style="text-align: left;">Command/Query ▲▼</th> <th style="text-align: left;">Response</th> </tr> </thead> <tbody> <tr> <td>Motor[1].PlusLimit</td> <td>0</td> </tr> <tr> <td>Motor[1].MinusLimit</td> <td>0</td> </tr> <tr style="border: 2px solid red;"> <td>Motor[2].PlusLimit</td> <td>1</td> </tr> <tr> <td>Motor[2].MinusLimit</td> <td>0</td> </tr> </tbody> </table>  | Command/Query ▲▼ | Response | Motor[1].PlusLimit | 0 | Motor[1].MinusLimit | 0 | Motor[2].PlusLimit | 1 | Motor[2].MinusLimit | 0 |
| Command/Query ▲▼                                                                                             | Response                                                                                                                                                                                                                                                                                                                                                                                                                                                                                                                                               |                  |          |                    |   |                     |   |                    |   |                     |   |
| Motor[1].PlusLimit                                                                                           | 0                                                                                                                                                                                                                                                                                                                                                                                                                                                                                                                                                      |                  |          |                    |   |                     |   |                    |   |                     |   |
| Motor[1].MinusLimit                                                                                          | 0                                                                                                                                                                                                                                                                                                                                                                                                                                                                                                                                                      |                  |          |                    |   |                     |   |                    |   |                     |   |
| Motor[2].PlusLimit                                                                                           | 1                                                                                                                                                                                                                                                                                                                                                                                                                                                                                                                                                      |                  |          |                    |   |                     |   |                    |   |                     |   |
| Motor[2].MinusLimit                                                                                          | 0                                                                                                                                                                                                                                                                                                                                                                                                                                                                                                                                                      |                  |          |                    |   |                     |   |                    |   |                     |   |
| <p><b>5</b> Confirm that <i>Motor[2].MinusLimit</i> of the Y-axis negative overtravel limit switch is 1.</p> |  <table border="1" style="width: 100%; border-collapse: collapse;"> <thead> <tr> <th style="text-align: left;">Command/Query ▲▼</th> <th style="text-align: left;">Response</th> </tr> </thead> <tbody> <tr> <td>Motor[1].PlusLimit</td> <td>0</td> </tr> <tr> <td>Motor[1].MinusLimit</td> <td>0</td> </tr> <tr> <td>Motor[2].PlusLimit</td> <td>0</td> </tr> <tr style="border: 2px solid red;"> <td>Motor[2].MinusLimit</td> <td>1</td> </tr> </tbody> </table> | Command/Query ▲▼ | Response | Motor[1].PlusLimit | 0 | Motor[1].MinusLimit | 0 | Motor[2].PlusLimit | 0 | Motor[2].MinusLimit | 1 |
| Command/Query ▲▼                                                                                             | Response                                                                                                                                                                                                                                                                                                                                                                                                                                                                                                                                               |                  |          |                    |   |                     |   |                    |   |                     |   |
| Motor[1].PlusLimit                                                                                           | 0                                                                                                                                                                                                                                                                                                                                                                                                                                                                                                                                                      |                  |          |                    |   |                     |   |                    |   |                     |   |
| Motor[1].MinusLimit                                                                                          | 0                                                                                                                                                                                                                                                                                                                                                                                                                                                                                                                                                      |                  |          |                    |   |                     |   |                    |   |                     |   |
| Motor[2].PlusLimit                                                                                           | 0                                                                                                                                                                                                                                                                                                                                                                                                                                                                                                                                                      |                  |          |                    |   |                     |   |                    |   |                     |   |
| Motor[2].MinusLimit                                                                                          | 1                                                                                                                                                                                                                                                                                                                                                                                                                                                                                                                                                      |                  |          |                    |   |                     |   |                    |   |                     |   |

### 3-5-4 Setup of Home Positions

Set up the home positions.

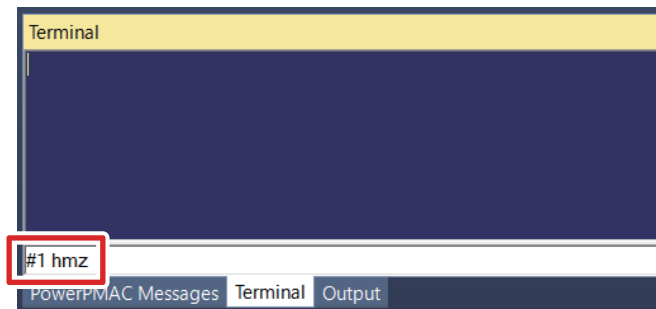
|                                                                                                                         |                                                                                                                                                                                                                                                                                                                                                                                        |
|-------------------------------------------------------------------------------------------------------------------------|----------------------------------------------------------------------------------------------------------------------------------------------------------------------------------------------------------------------------------------------------------------------------------------------------------------------------------------------------------------------------------------|
| <p><b>1</b> Move the X axis to the home position and type the <b>#1 hmz</b> command in the Power PMAC IDE Terminal.</p> |  <p>The screenshot shows a terminal window with a dark blue background. The command <code>#1 hmz</code> is entered at the prompt and is highlighted with a red box. The terminal title bar reads "Terminal". At the bottom, there are tabs for "PowerPMAC Messages", "Terminal", and "Output".</p> |
|-------------------------------------------------------------------------------------------------------------------------|----------------------------------------------------------------------------------------------------------------------------------------------------------------------------------------------------------------------------------------------------------------------------------------------------------------------------------------------------------------------------------------|

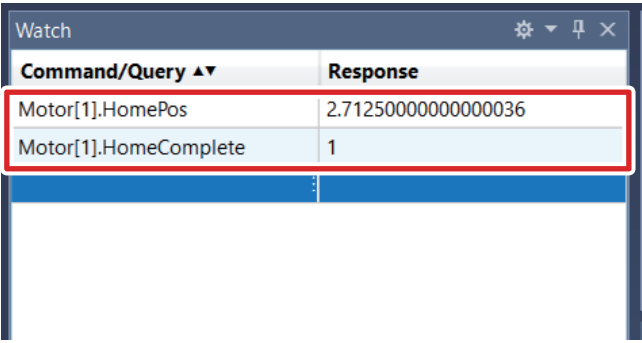
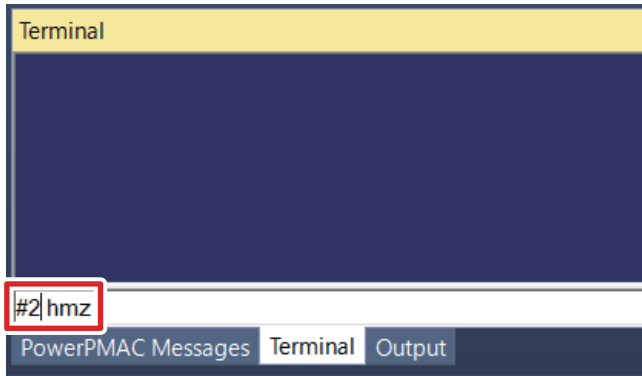
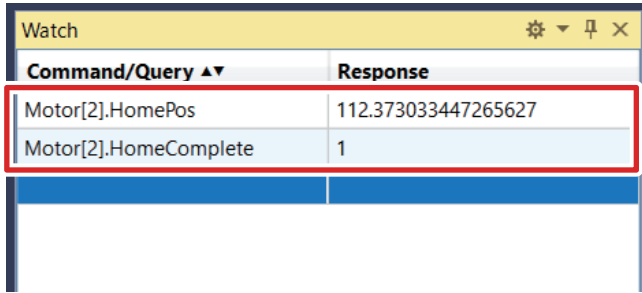
| <p><b>2</b></p> <p>Confirm that the following variables are correctly reflected.</p> <ul style="list-style-type: none"> <li>• <i>Motor[1].HomePos</i>: Home trigger position</li> <li>• <i>Motor[1].HomeComplete</i>: 1</li> </ul> |  <p>The Watch window displays a table with two rows. The first row shows 'Motor[1].HomePos' with a response of '2.71250000000000036'. The second row shows 'Motor[1].HomeComplete' with a response of '1'. Both rows are highlighted with a red border.</p> <table border="1"> <thead> <tr> <th>Command/Query ▲▼</th> <th>Response</th> </tr> </thead> <tbody> <tr> <td>Motor[1].HomePos</td> <td>2.71250000000000036</td> </tr> <tr> <td>Motor[1].HomeComplete</td> <td>1</td> </tr> </tbody> </table>   | Command/Query ▲▼ | Response | Motor[1].HomePos | 2.71250000000000036 | Motor[1].HomeComplete | 1 |
|------------------------------------------------------------------------------------------------------------------------------------------------------------------------------------------------------------------------------------|---------------------------------------------------------------------------------------------------------------------------------------------------------------------------------------------------------------------------------------------------------------------------------------------------------------------------------------------------------------------------------------------------------------------------------------------------------------------------------------------------------------------------------------------------------------------------------------------|------------------|----------|------------------|---------------------|-----------------------|---|
| Command/Query ▲▼                                                                                                                                                                                                                   | Response                                                                                                                                                                                                                                                                                                                                                                                                                                                                                                                                                                                    |                  |          |                  |                     |                       |   |
| Motor[1].HomePos                                                                                                                                                                                                                   | 2.71250000000000036                                                                                                                                                                                                                                                                                                                                                                                                                                                                                                                                                                         |                  |          |                  |                     |                       |   |
| Motor[1].HomeComplete                                                                                                                                                                                                              | 1                                                                                                                                                                                                                                                                                                                                                                                                                                                                                                                                                                                           |                  |          |                  |                     |                       |   |
| <p><b>3</b></p> <p>Move the Y axis to the home position and type the <b>#2 hmz</b> command in the Power PMAC IDE Terminal.</p>                                                                                                     |  <p>The Terminal window shows the command '#2 hmz' entered. The terminal has tabs for 'PowerPMAC Messages', 'Terminal', and 'Output'. The 'Terminal' tab is active.</p>                                                                                                                                                                                                                                                                                                                                   |                  |          |                  |                     |                       |   |
| <p><b>4</b></p> <p>Confirm that the following variables are correctly reflected.</p> <ul style="list-style-type: none"> <li>• <i>Motor[2].HomePos</i>: Home trigger position</li> <li>• <i>Motor[2].HomeComplete</i>: 1</li> </ul> |  <p>The Watch window displays a table with two rows. The first row shows 'Motor[2].HomePos' with a response of '112.373033447265627'. The second row shows 'Motor[2].HomeComplete' with a response of '1'. Both rows are highlighted with a red border.</p> <table border="1"> <thead> <tr> <th>Command/Query ▲▼</th> <th>Response</th> </tr> </thead> <tbody> <tr> <td>Motor[2].HomePos</td> <td>112.373033447265627</td> </tr> <tr> <td>Motor[2].HomeComplete</td> <td>1</td> </tr> </tbody> </table> | Command/Query ▲▼ | Response | Motor[2].HomePos | 112.373033447265627 | Motor[2].HomeComplete | 1 |
| Command/Query ▲▼                                                                                                                                                                                                                   | Response                                                                                                                                                                                                                                                                                                                                                                                                                                                                                                                                                                                    |                  |          |                  |                     |                       |   |
| Motor[2].HomePos                                                                                                                                                                                                                   | 112.373033447265627                                                                                                                                                                                                                                                                                                                                                                                                                                                                                                                                                                         |                  |          |                  |                     |                       |   |
| Motor[2].HomeComplete                                                                                                                                                                                                              | 1                                                                                                                                                                                                                                                                                                                                                                                                                                                                                                                                                                                           |                  |          |                  |                     |                       |   |

# 3-6 Setup of the Galvo Scanner

## 3-6-1 Wiring of Devices

The figures below show how to wire the CK3M to the Galvo Scanner.

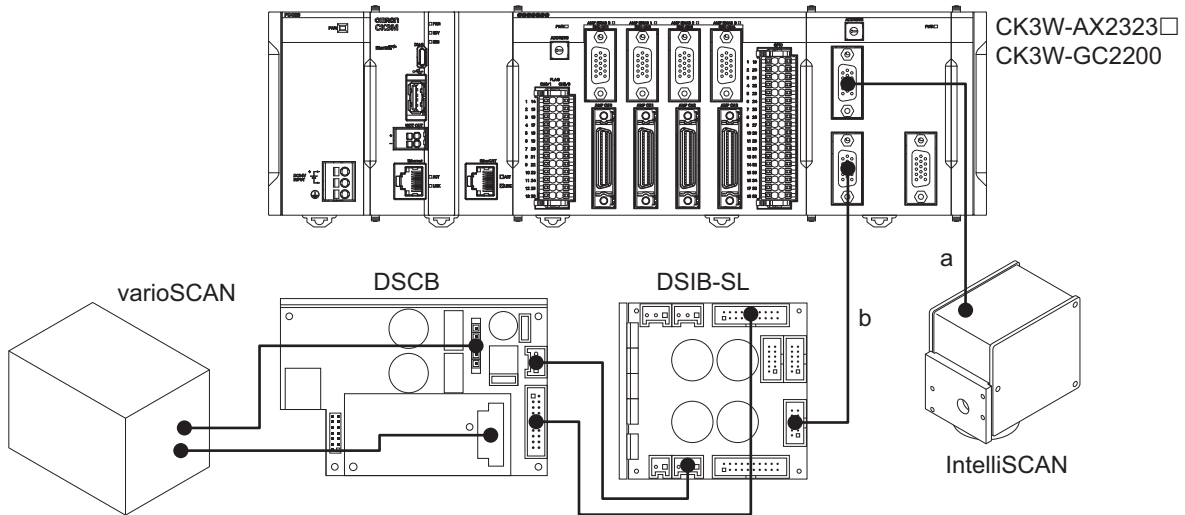

Connect the sections a and b in the above figures as follows.

a. Connection between the Controller and the Galvo Scanner

Connect the XY connector of the CK3W-GC2200 to the SL2-100 connector of the IntelliSCAN with the dedicated cable CK3W-CAG03A.

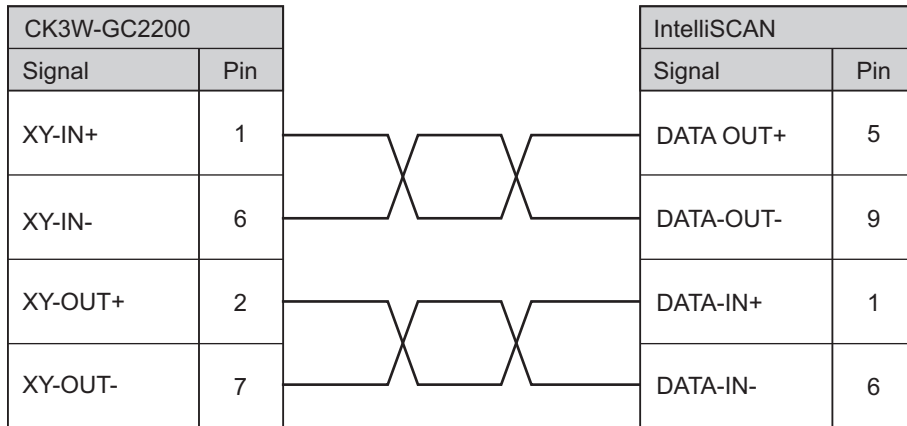

b. Connection between the Controller and the dynamic focusing unit

Connect the Z connector of the CK3W-GC2200 to the DIGITAL IN connector of the DSIB-SL with the dedicated cable CK3W-CAG03A.

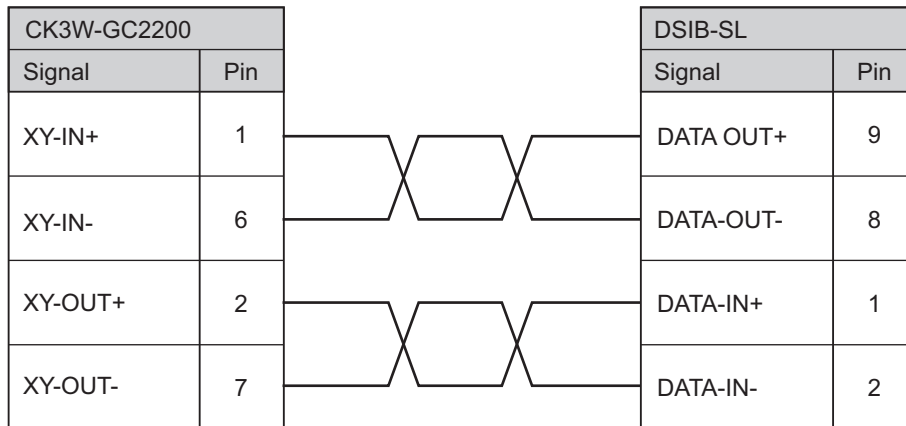

## 3-6-2 Programming

Program the settings of the Galvo Scanner.

- 1 In the Solution Explorer, right-click **Global Includes** under **PMAC Script Language** and select **Add – New Item....**

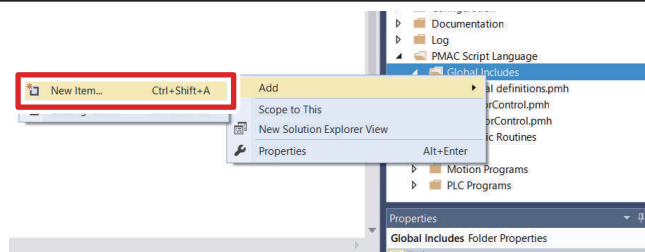

- 2 In the **Name** box, type *Galvano.pmh* and click the **Add** button.

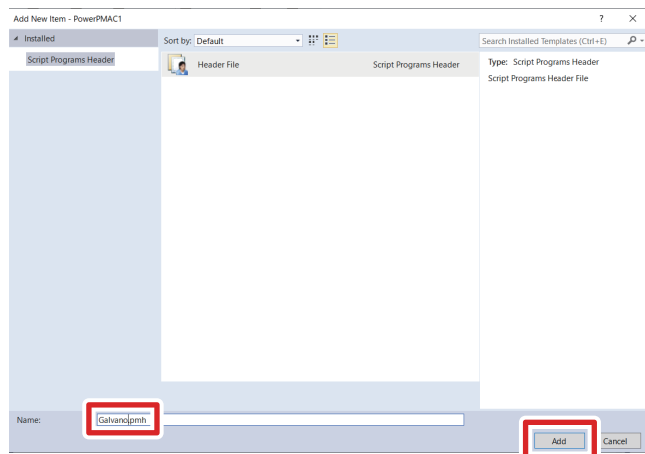

- 3 Open the **Galvano.pmh** file under **PMAC Script Language – Global Includes** in the Solution Explorer.

## 4

Write the text shown on the right to the Galvano.pmh file.

- For details on the annotated settings, refer to *Section 4 How to Customize Various Settings* on page 4-1.

```

Sys.WpKey=$AAAAAAAA

//SL2-100 Configurations
Gate3[1].SerialEncCtrl=$82800//*1

//Servo Task Configurations
Motor[3].ServoCtrl=1//*2
Motor[4].ServoCtrl=1//*2
Motor[5].ServoCtrl=1//*2
Motor[3].Ctrl=Sys.PosCtrl//*3
Motor[4].Ctrl=Sys.PosCtrl//*3
Motor[5].Ctrl=Sys.PosCtrl//*3
Motor[3].MaxSpeed=0//*4
Motor[4].MaxSpeed=0//*4
Motor[5].MaxSpeed=0//*4

//Motor Output Configurations
Motor[3].MaxPos=0//*5
Motor[4].MaxPos=0//*5
Motor[5].MaxPos=0//*5
Motor[3].MinPos=0//*6
Motor[4].MinPos=0//*6
Motor[5].MinPos=0//*6
Motor[3].pDac=Gate3[1].Chan[0].Dac[0].a//*7
Motor[4].pDac=Gate3[1].Chan[1].Dac[0].a//*7
Motor[5].pDac=Gate3[1].Chan[2].Dac[0].a//*7
Motor[3].pLimits=0//*8
Motor[4].pLimits=0//*8
Motor[5].pLimits=0//*8
Motor[3].FatalFeLimit=0//*9
Motor[4].FatalFeLimit=0//*9
Motor[5].FatalFeLimit=0//*9

//Encoder Input Configurations
Motor[3].pEnc=EncTable[3].a//*10
Motor[4].pEnc=EncTable[4].a//*10
Motor[5].pEnc=EncTable[5].a//*10
Motor[3].pEnc2=EncTable[3].a//*11
Motor[4].pEnc2=EncTable[4].a//*11
Motor[5].pEnc2=EncTable[5].a//*11
EncTable[3].Type=1//*12
EncTable[4].Type=1//*12
EncTable[5].Type=1//*12
EncTable[3].pEnc=Gate3[1].Chan[0].SerialEncDataA.
a//*13
EncTable[4].pEnc=Gate3[1].Chan[1].SerialEncDataA.
a//*13
EncTable[5].pEnc=Gate3[1].Chan[2].SerialEncDataA.
a//*13
EncTable[3].ScaleFactor=1/4096//*14
EncTable[4].ScaleFactor=1/4096//*14
EncTable[5].ScaleFactor=1/4096//*14

//Enable Motor 6
Motor[6].ServoCtrl=1//*2
Motor[6].pDac=Sys.Udata[0].a

```

- 5** Right click on the Solution Explorer project name at the upper right of the Power PMAC IDE screen, select **Build and Download All Programs**, and execute Build and Download.

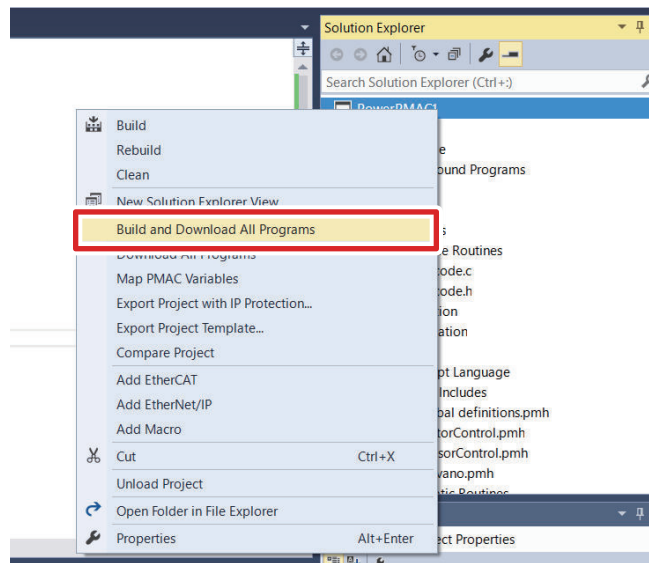

- 6** Make sure that there are no errors in the Output window.

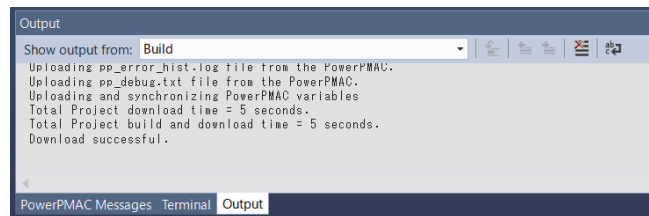

### 3-6-3 Setup of Control Commands

Set the feedback signal of the Galvo Scanner to the current position.

- 1** Type the **Motor[3].pDac=Sys.Udata[0].a** command in the Power PMAC IDE Terminal.

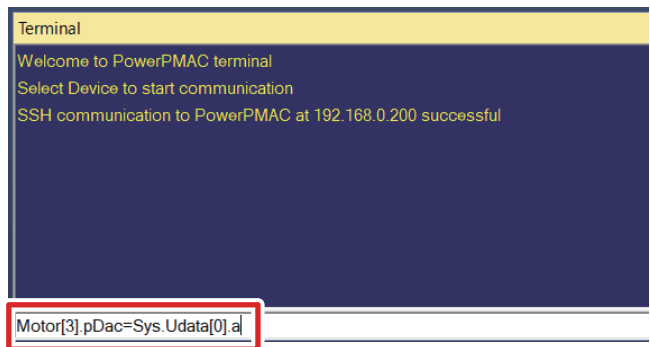

- 2** Type the **Motor[4].pDac=Sys.Udata[0].a** command in the Power PMAC IDE Terminal.

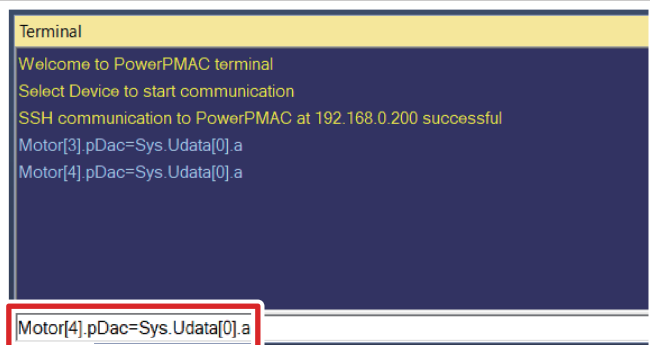

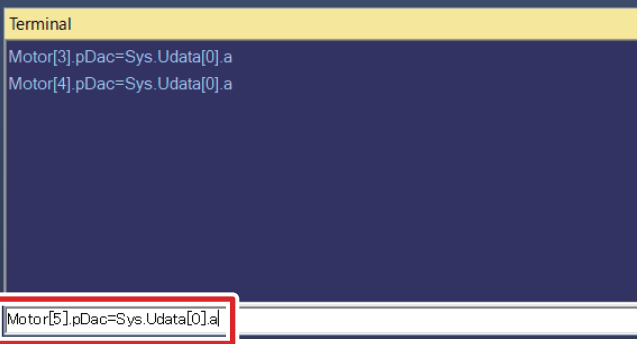
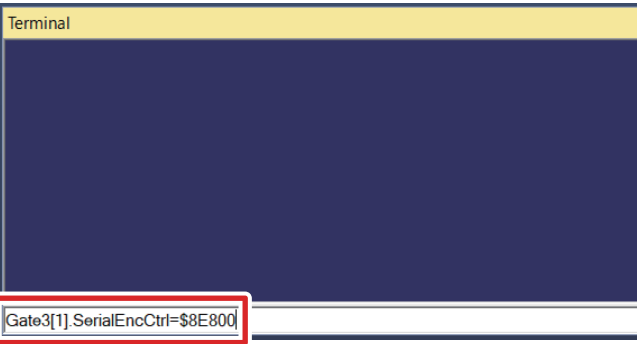
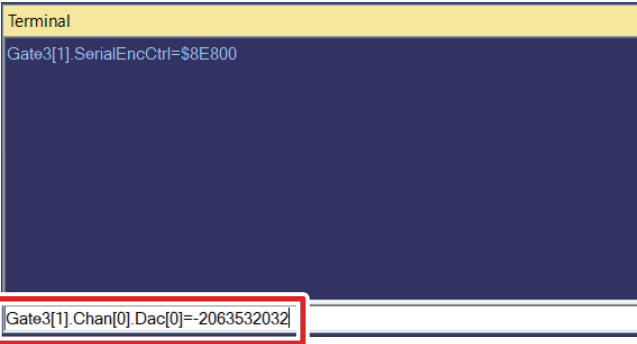
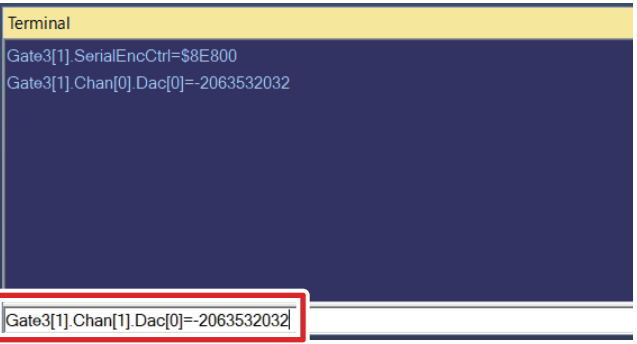
|          |                                                                                            |                                                                                                                                                                                                               |
|----------|--------------------------------------------------------------------------------------------|---------------------------------------------------------------------------------------------------------------------------------------------------------------------------------------------------------------|
| <b>3</b> | Type the <b>Motor[5].pDac=Sys.Udata[0].a</b> command in the Power PMAC IDE Terminal.       |  <pre>Terminal Motor[3].pDac=Sys.Udata[0].a Motor[4].pDac=Sys.Udata[0].a Motor[5].pDac=Sys.Udata[0].a</pre>                 |
| <b>4</b> | Type the <b>Gate3[1].SerialEncCtrl=\$8E800</b> command in the Power PMAC IDE Terminal.     |  <pre>Terminal Gate3[1].SerialEncCtrl=\$8E800</pre>                                                                         |
| <b>5</b> | Type the <b>Gate3[1].Chan[0].Dac[0]=-206353203</b> command in the Power PMAC IDE Terminal. |  <pre>Terminal Gate3[1].SerialEncCtrl=\$8E800 Gate3[1].Chan[0].Dac[0]=-206353203</pre>                                    |
| <b>6</b> | Type the <b>Gate3[1].Chan[1].Dac[0]=-206353203</b> command in the Power PMAC IDE Terminal. |  <pre>Terminal Gate3[1].SerialEncCtrl=\$8E800 Gate3[1].Chan[0].Dac[0]=-206353203 Gate3[1].Chan[1].Dac[0]=-206353203</pre> |



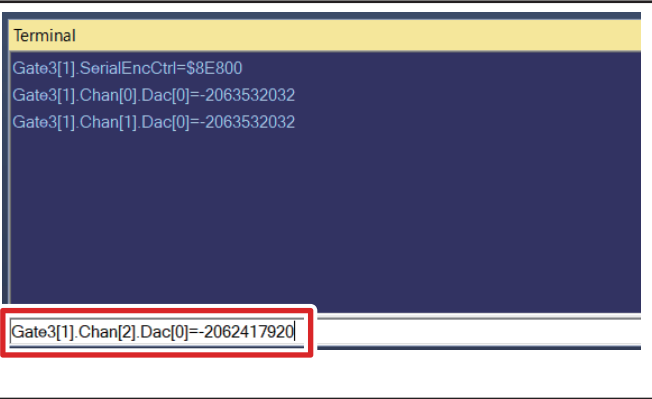
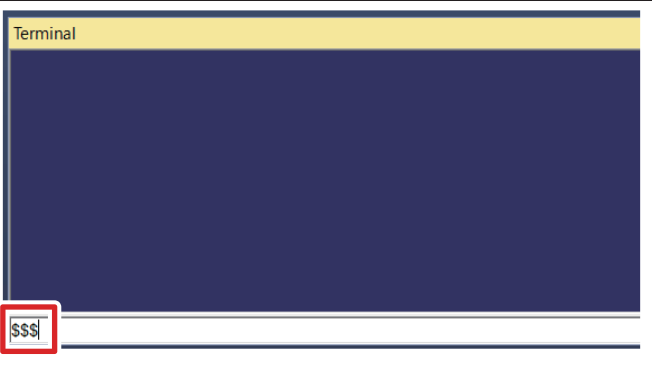

|   |                                                                                             |                                                                                    |
|---|---------------------------------------------------------------------------------------------|------------------------------------------------------------------------------------|
| 7 | Type the <b>Gate3[1].Chan[2].Dac[0]=-2062417920</b> command in the Power PMAC IDE Terminal. |  |
| 8 | Type the <b>\$\$\$</b> command in the Power PMAC IDE Terminal.                              |  |

### 3-6-4 Confirmation of the Settings

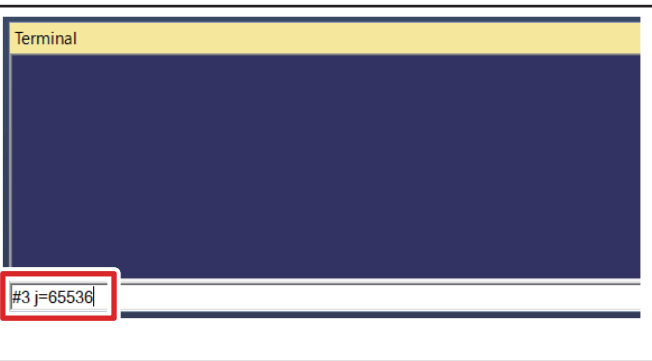
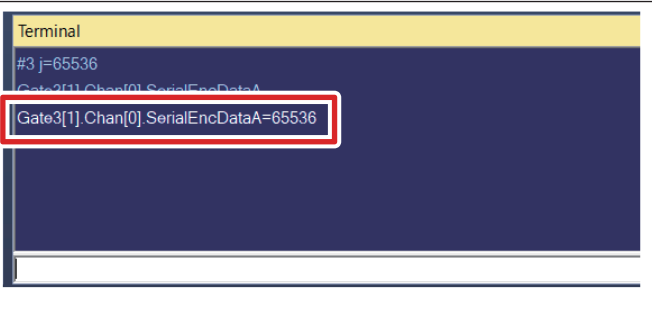
Confirm that the settings of the Galvo Scanner are correct.

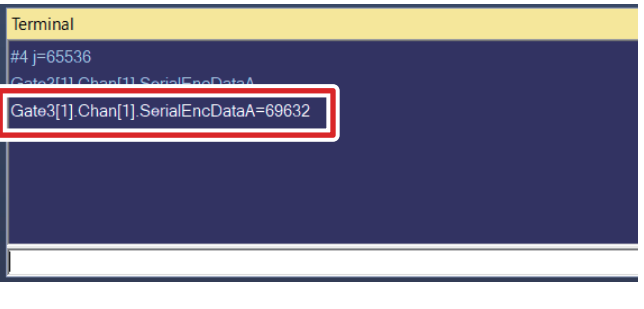
|   |                                                                        |                                                                                      |
|---|------------------------------------------------------------------------|--------------------------------------------------------------------------------------|
| 1 | Type the <b>#3 j=65536</b> command in the Power PMAC IDE Terminal.     |  |
| 2 | Confirm that Gate3[0].Chan[0].SerialEncDataA=65536 or so is displayed. |  |

|                 |                                                                                |                                                                                     |
|-----------------|--------------------------------------------------------------------------------|-------------------------------------------------------------------------------------|
| <p><b>3</b></p> | <p>Type the <b>#4 j=65536</b> command in the Power PMAC IDE Terminal.</p>      |   |
| <p><b>4</b></p> | <p>Confirm that Gate3[1].Chan[1].Serial-EncDataA=65536 or so is displayed.</p> |   |
| <p><b>5</b></p> | <p>Type the <b>#5 j=65536</b> command in the Power PMAC IDE Terminal.</p>      |  |
| <p><b>6</b></p> | <p>Confirm that Gate3[0].Chan[2].Serial-EncDataA=65536 or so is displayed.</p> |                                                                                     |

### 3-6-5 Verification of the MOTF on the Actual Machine

Confirm that the settings of the MOTF are operating correctly on the actual machine.

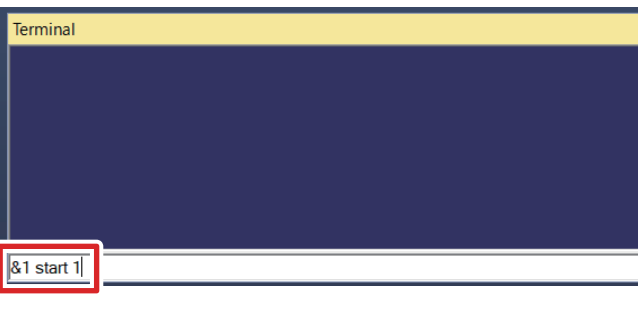
|                 |                                                                                                          |                                                                                      |
|-----------------|----------------------------------------------------------------------------------------------------------|--------------------------------------------------------------------------------------|
| <p><b>1</b></p> | <p>Type the <b>&amp;1 start 1</b> command in the Power PMAC IDE Terminal.</p>                            |  |
| <p><b>2</b></p> | <p>Confirm that the linear motors and Galvo Scanner for the X and Y axes operate in synchronization.</p> |                                                                                      |

## 3-7 Setup of the Laser Oscillator

### 3-7-1 Wiring of Devices

The figures below show how to wire the CK3M to the laser oscillator.

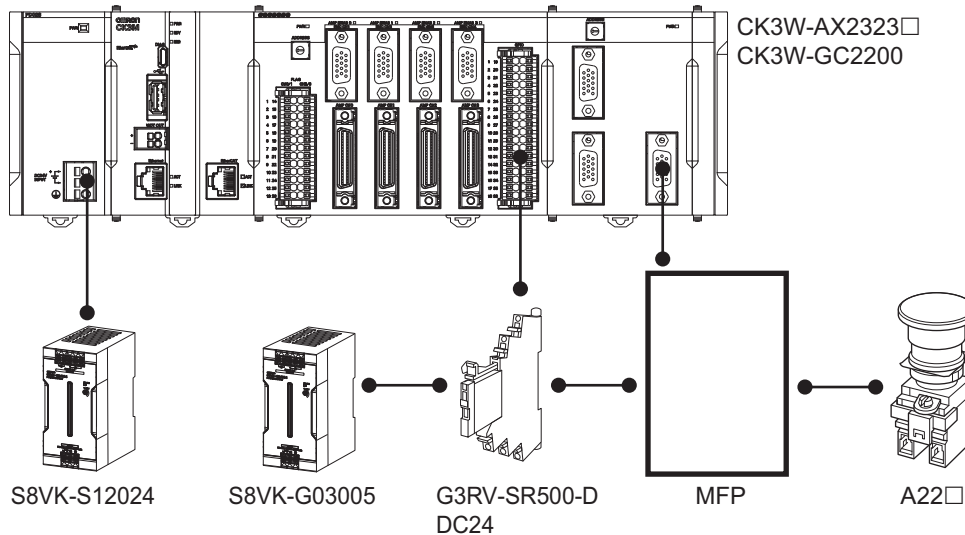

Connect the GPIO terminal of the CK3W-AX2323N to the MFP as shown below.

- OUT 0: Pin 5 of the MFP
- OUT 1: Pin 6 of the MFP
- OUT 2: Pin 7 of the MFP
- OUT 3: Pin 8 of the MFP
- OUT 4: Pin 9 of the MFP
- OUT 5: Pin 18 of the MFP
- OUT 6: Pin 22 of the MFP

Connect the LASER terminal of the CK3W-GC2200 to the MFP as shown below.

- OUT 0: Pin 20 of the MFP
- OUT 1: Pin 21 of the MFP



### 3-7-2 Guide Laser Output

Confirm that the guide laser light is output correctly.

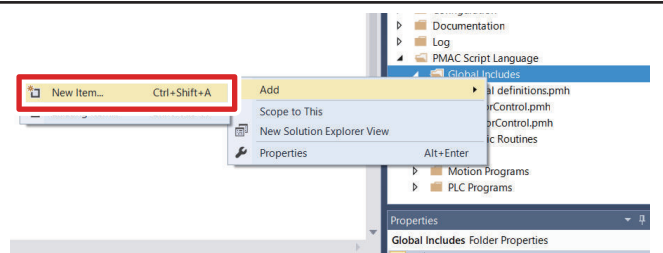
- 1 In the Solution Explorer, right-click **Global Includes** under **PMAC Script Language** and select **Add – New Item....**



- 2 In the **Name** box, type *LaserDefinitions.pmh* and click the **Add** button.

| <p><b>3</b></p>                 | <p>In the Solution Explorer, open the <b>LaserControl.pmh</b> file under <b>PMAC Script Language – Global Includes</b> and add the text shown on the right.</p> | <pre>ptr LaserPower-&gt;Gate3[0].GpioData[0].16.4 ptr LaserLatch-&gt;Gate3[0].GpioData[0].20.1 ptr MasterOscillator-&gt;Gate3[0].GpioData[0].21.1 ptr GuideLaser-&gt;Gate3[0].GpioData[0].22.1</pre>                                                                                                                                                                                                                                                                                                                                                                                                                                                                                                                                                                                                                                                                       |                  |          |                                 |        |
|---------------------------------|-----------------------------------------------------------------------------------------------------------------------------------------------------------------|----------------------------------------------------------------------------------------------------------------------------------------------------------------------------------------------------------------------------------------------------------------------------------------------------------------------------------------------------------------------------------------------------------------------------------------------------------------------------------------------------------------------------------------------------------------------------------------------------------------------------------------------------------------------------------------------------------------------------------------------------------------------------------------------------------------------------------------------------------------------------|------------------|----------|---------------------------------|--------|
| <p><b>4</b></p>                 | <p>Type the <b>GuideLaser=1</b> command in the Power PMAC IDE Terminal and confirm that guide laser light is output.</p>                                        |  <p>A screenshot of a terminal window with a yellow title bar labeled 'Terminal'. The background is dark blue. The text 'GuideLaser=1' is entered at the bottom of the terminal, highlighted by a red rectangular box.</p>                                                                                                                                                                                                                                                                                                                                                                                                                                                                                                                                                               |                  |          |                                 |        |
| <p><b>5</b></p>                 | <p>Type the <b>#3 j=0</b> command in the Power PMAC IDE Terminal and confirm that Gate3[1].Chan[0].SerialEncDataA=0 or so is displayed.</p>                     |  <p>Two screenshots are shown. The top one is a terminal window with a yellow title bar labeled 'Terminal'. The text 'GuideLaser=1' is visible above the command '#3 j=0', which is entered at the bottom and highlighted by a red rectangular box. The bottom screenshot is a 'Watch' window with a yellow title bar. It contains a table with two columns: 'Command/Query' and 'Response'. The first row is highlighted with a red rectangular box and shows 'Gate3[1].Chan[0].SerialEncDataA' in the command column and '-12288' in the response column.</p> <table border="1" data-bbox="794 1077 1442 1413"> <thead> <tr> <th>Command/Query ▲▼</th> <th>Response</th> </tr> </thead> <tbody> <tr> <td>Gate3[1].Chan[0].SerialEncDataA</td> <td>-12288</td> </tr> </tbody> </table> | Command/Query ▲▼ | Response | Gate3[1].Chan[0].SerialEncDataA | -12288 |
| Command/Query ▲▼                | Response                                                                                                                                                        |                                                                                                                                                                                                                                                                                                                                                                                                                                                                                                                                                                                                                                                                                                                                                                                                                                                                            |                  |          |                                 |        |
| Gate3[1].Chan[0].SerialEncDataA | -12288                                                                                                                                                          |                                                                                                                                                                                                                                                                                                                                                                                                                                                                                                                                                                                                                                                                                                                                                                                                                                                                            |                  |          |                                 |        |

**6** Type the **#4 j=0** command in the Power PMAC IDE Terminal and confirm that Gate3[1].Chan[1].SerialEncDataA=0 is displayed.



The Terminal window shows the following text:

```
Terminal
GuideLaser=1
#3 j=0
#4 j=0
```

The input field contains `#4 j=0`.

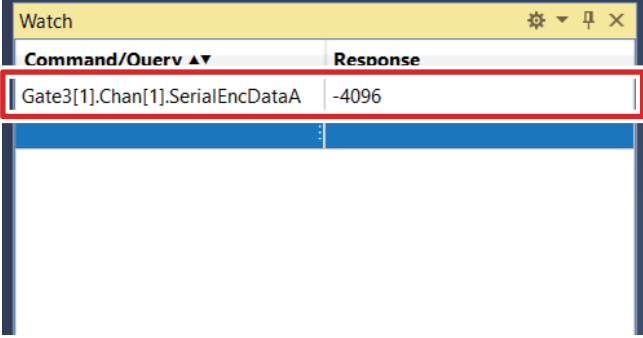

The Watch window displays the following data:

| Command/Querv                   | Response |
|---------------------------------|----------|
| Gate3[1].Chan[1].SerialEncDataA | -4096    |

**7** Confirm that the guide laser light is output to the center of the XY table.

**8** Type the **#5 j={Position}** command in the Power PMAC IDE Terminal and confirm that the spot diameter of guide laser light is appropriate.

**9** Type the **GuideLaser=0** command in the Power PMAC IDE Terminal and confirm that guide laser light is not output.



The Terminal window shows the following text:

```
Terminal
GuideLaser=1
#3 j=0
#4 j=0
```

The input field contains `GuideLaser=0`.

### 3-7-3 Programming

Program the settings of the laser oscillator.

- 1** In the Solution Explorer, right-click **Global Includes** under **PMAC Script Language** and select **Add – New Item....**

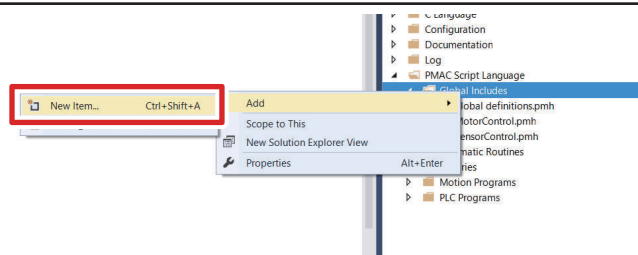

**2** In the **Name** box, type *LaserControl.pmh* and click the **Add** button.

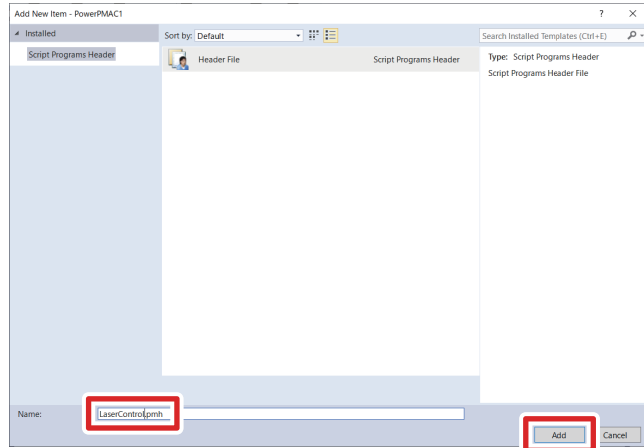

**3** In the Solution Explorer, open the **LaserControl.pmh** file under **PMAC Script Language – Global Includes** and add the text shown on the right.

- For details on the annotated settings, refer to *Section 4 How to Customize Various Settings* on page 4-1.

```
Sys.WpKey=$AAAAAAAAA

//Q-Switch Configurations
Gate3[1].Chan[0].CompA=$8000D000//*1
Gate3[1].Chan[1].CompA=$0//*2

//Laser Output Configurations
Gate3[1].Chan[2].CompA=$FFF00//*3
```

**4** In the Solution Explorer, right-click the **Realtime Routines** file under **C Language** and select **User servo setup**.

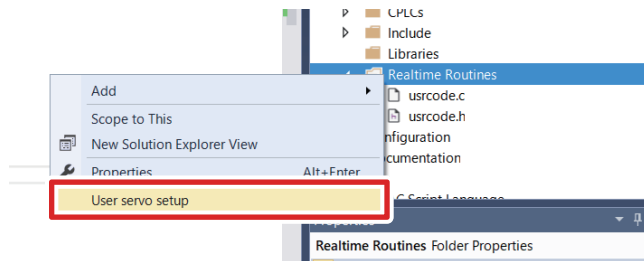

**5** Click the **Add a New Function** button.

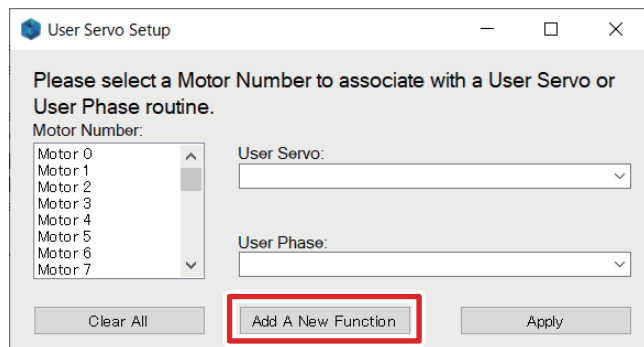

**6** Type *CalcTableBasedCompare* and click the **Apply** button.

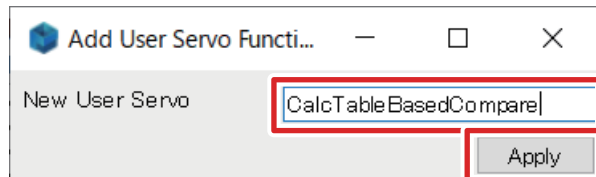

- 7 Select **Motor 6**, and then select **CalcTableBasedCompare** from the **User Servo** list.

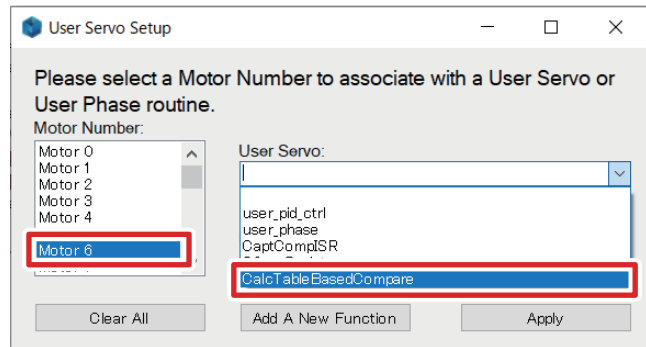

- 8 Click the **Apply** button.

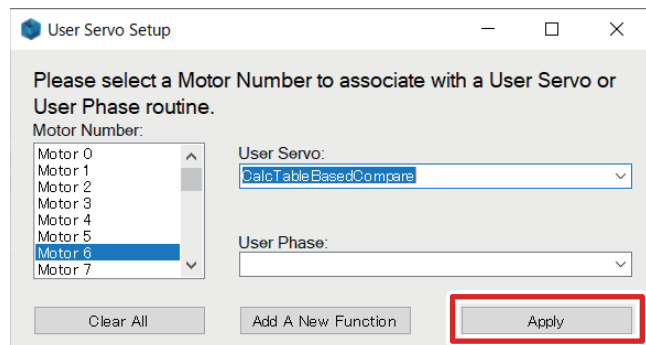

- 9 In the Solution Explorer, click the **usercode.c** file under **C Language – Realtime Routines** and add the functions shown on the right.

```
static double X_old=0;
static double Y_old=0;
static double SumDistance=0;

double CalcTableBasedCompare(struct MotorData*Mpt
r)
{
    volatile GateArray3 *MySecondGate3IC;
    MySecondGate3IC=GetGate3MemPtr(1);

    double X_now;
    X_now=pshm->Motor[1].DesPos+pshm->Motor[3].DesPo
s;
    double Y_now;
    Y_now=pshm->Motor[2].DesPos+pshm->Motor[4].DesPo
s;
    double distance;
    distance=sqrt((X_old-X_now)*(X_old-X_now)+(Y_old
-Y_now)*(Y_old-Y_now));
    if(DistanceCountOn) SumDistance+=distance;

    X_old=X_now;
    Y_old=Y_now;
    MySecondGate3IC->Chan[0].CompB=SumDistance;

    return 0;
}
```

- 10** In the Solution Explorer, right-click **Global Includes** under **PMAC Script Language** and select **Add – New Item...**. In the Name box, type *TCRConfigurations.pmh* and click the **Add** button.

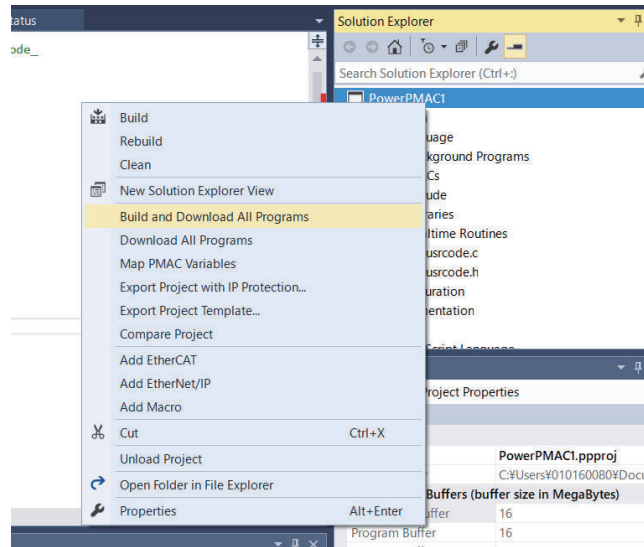

- 11** Write the text shown on the right to the *TCRConfigurations.pmh* file.
- For details on the annotated settings, refer to *Section 4 How to Customize Various Settings* on page 4-1.

```
global DistanceCountOn
Gate3[1].Chan[1].CompB=50.0*1.414// *1
Gate3[1].Chan[1].CompB=50.0*1.414+400// *2
//Gate3[1].Chan[1].CompB=***
Gate3[1].Chan[2].CompB=$80000000// *3
```

- 12** Right click on the Solution Explorer project name at the upper right of the Power PMAC IDE screen, select **Build and Download All Programs**, and execute Build and Download.

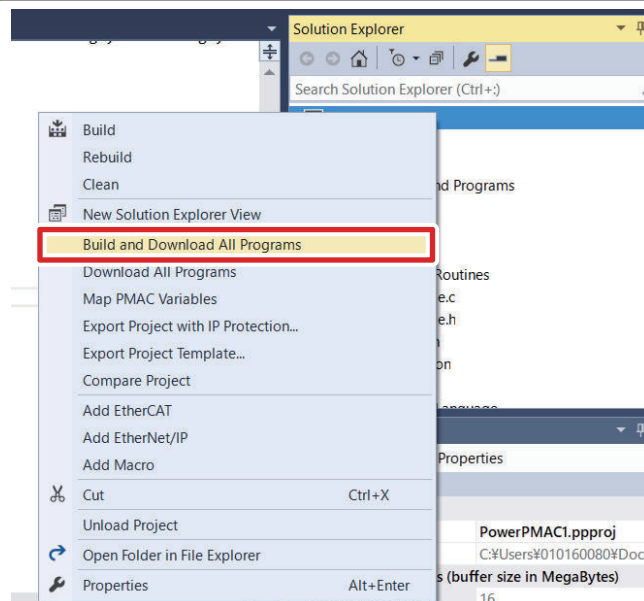

- 13** Make sure that there are no errors in the Output window.

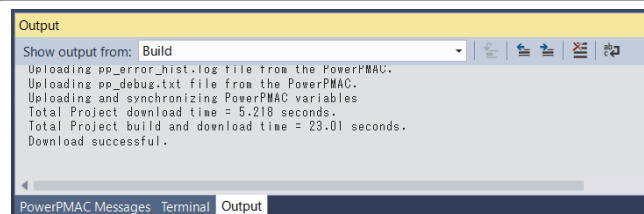

### 3-7-4 Setup of the Laser Oscillator

Set up the power of the laser oscillator and make preliminary preparations for laser output.

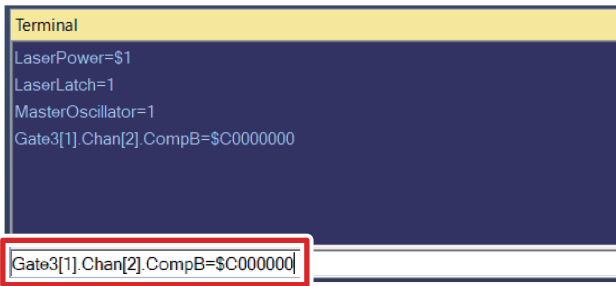

|   |                                                                           |                                                                                                                                                                                                                                                          |
|---|---------------------------------------------------------------------------|----------------------------------------------------------------------------------------------------------------------------------------------------------------------------------------------------------------------------------------------------------|
| 1 | Confirm that the emergency stop push-button switch is OFF.                |                                                                                                                                                                                                                                                          |
| 2 | Type the <b>LaserPower=\$1</b> command in the Terminal.                   |  <p>Terminal</p> <pre>LaserPower=\$1</pre>                                                                                                                             |
| 3 | Type the <b>LaserLatch=1</b> command in the Terminal.                     |  <p>Terminal</p> <pre>LaserPower=\$1 LaserLatch=1</pre>                                                                                                                |
| 4 | Type the <b>MasterOscillator=1</b> command in the Terminal.               |  <p>Terminal</p> <pre>LaserPower=\$1 LaserLatch=1 MasterOscillator=1</pre>                                                                                            |
| 5 | Type the <b>Gate3[1].Chan[2].CompB=\$C000000</b> command in the Terminal. |  <p>Terminal</p> <pre>LaserPower=\$1 LaserLatch=1 MasterOscillator=1 Gate3[1].Chan[2].CompB=\$C000000</pre>                                                          |
| 6 | Confirm that the laser light is output.                                   |                                                                                                                                                                                                                                                          |
| 7 | Type the <b>Gate3[1].Chan[2].CompB=\$0</b> command in the Terminal.       |  <p>Terminal</p> <pre>Welcome to PowerPMAC terminal Select Device to start communication First establish communication to PowerPMAC Gate3[1].Chan[2].CompB=\$0</pre> |

### 3-7-5 Confirmation of the Settings

Confirm that the settings in this document are made correctly, by checking whether the processing is actually available.

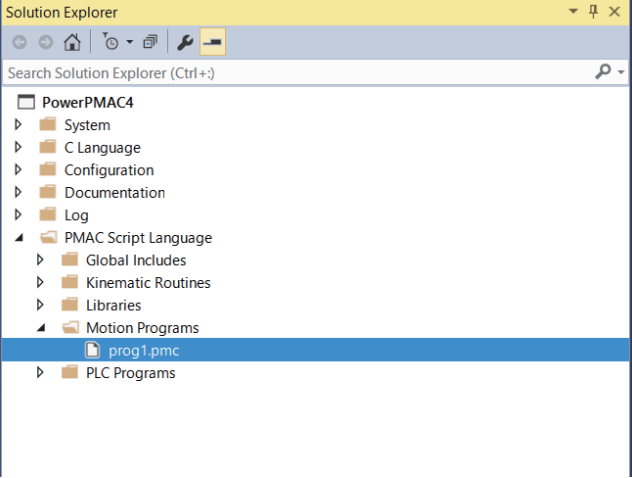
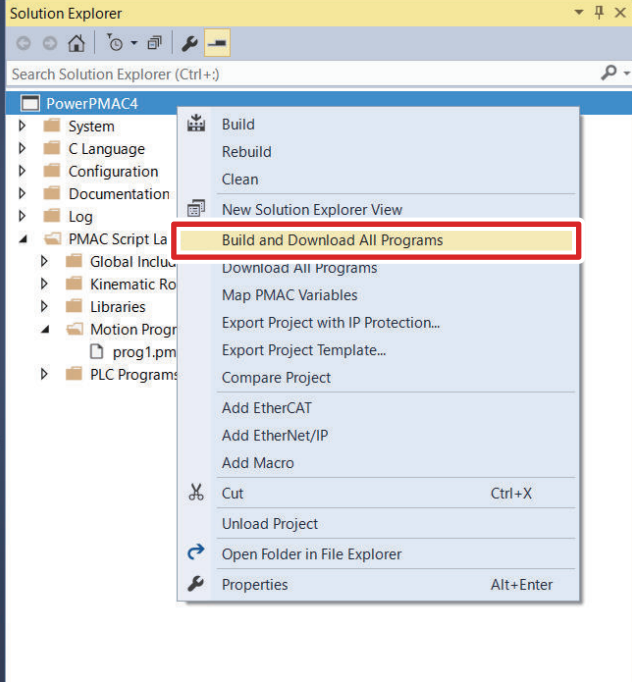
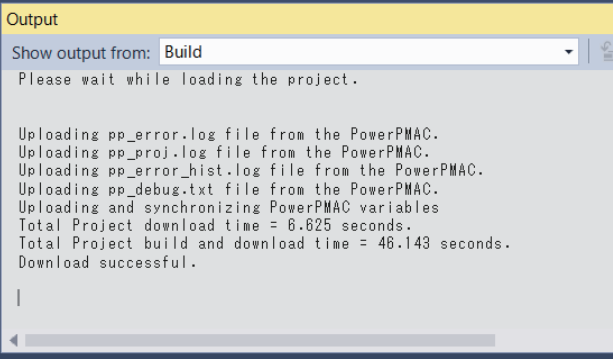
|                 |                                                                                                                                                                                                  |                                                                                      |
|-----------------|--------------------------------------------------------------------------------------------------------------------------------------------------------------------------------------------------|--------------------------------------------------------------------------------------|
| <p><b>1</b></p> | <p>Open the <b>prog1.pmc</b> file under <b>PMAC Script Language – Motion Programs</b> in the Solution Explorer.</p>                                                                              |    |
| <p><b>2</b></p> | <p>Write the program to use for processing to the prog1.pmc file.</p>                                                                                                                            |                                                                                      |
| <p><b>3</b></p> | <p>Right click on the Solution Explorer project name at the upper right of the Power PMAC IDE screen, select <b>Build and Download All Programs</b>, and execute Build and Download.</p>         |   |
| <p><b>4</b></p> | <p>Make sure that there are no errors in the Output window.</p> <ul style="list-style-type: none"> <li>• If the transfer failed, check the content of the error in the Output window.</li> </ul> |  |

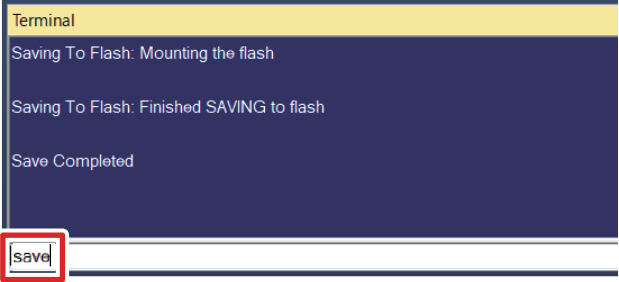
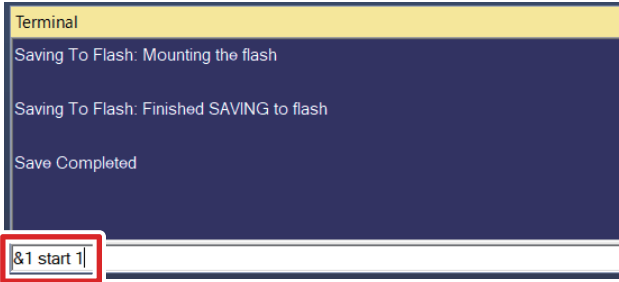
|          |                                                                                                                                                                                           |                                                                                    |
|----------|-------------------------------------------------------------------------------------------------------------------------------------------------------------------------------------------|------------------------------------------------------------------------------------|
| <b>5</b> | Type the <b>save</b> command in the Power PMAC IDE Terminal. <ul style="list-style-type: none"><li>• When the save is completed, "Save Completed" is displayed in the Terminal.</li></ul> |  |
| <b>6</b> | Type the <b>&amp;1 start 1</b> command in the Power PMAC IDE Terminal.                                                                                                                    |  |
| <b>7</b> | Confirm that the processing is completed correctly.                                                                                                                                       |                                                                                    |



# 4

## How to Customize Various Settings

This section describes how to customize various settings.

---

|     |                             |      |
|-----|-----------------------------|------|
| 4-1 | globaldefinitions.pmh ..... | 4-2  |
| 4-2 | MotionOnTheFly.pmh.....     | 4-3  |
| 4-3 | MotorControl.pmh .....      | 4-4  |
| 4-4 | SensorControl.pmh.....      | 4-7  |
| 4-5 | Galvano.pmh .....           | 4-8  |
| 4-6 | LaserControl.pmh .....      | 4-10 |
| 4-7 | TCRConfigurations.pmh.....  | 4-11 |

## 4-1 globaldefinitions.pmh

This file contains various clock and task period settings.

| No. | Parameter                | Description                                                                                                                                                                                                                                                                                                                                                                                                |
|-----|--------------------------|------------------------------------------------------------------------------------------------------------------------------------------------------------------------------------------------------------------------------------------------------------------------------------------------------------------------------------------------------------------------------------------------------------|
| *1  | Coord[1].SegMoveTime     | Specify the interpolation time period in ms for circular interpolation, etc. of the trajectory. The smaller this value, the closer to the exact trajectory, but the larger the computation load on the CPU due to the increase in the amount of computation.                                                                                                                                               |
| *2  | Gate3[0].PhaseFreq       | Specify the frequency of the phase clock. The larger this value, the more accurate the processing of current loops, etc., but the larger the computation load on the CPU due to the increase in the amount of computation.                                                                                                                                                                                 |
| *3  | Gate3[0].ServoClockDiv   | Specify the division ratio of the servo clock. The smaller this value, the more accurate the processing of position loops, etc., but the larger the computation load on the CPU due to the increase in the amount of computation.<br><br>The servo clock frequency is determined as follows according to the set value.<br>Servo clock frequency<br>= Phase clock frequency / (Gate3[0].ServoClockDiv + 1) |
| *4  | Sys.PhaseOverServoPeriod | Set the value calculated as follows.<br>Sys.PhaseOverServoPeriod<br>= 1 / (Gate3[0].ServoClockDiv + 1)                                                                                                                                                                                                                                                                                                     |
| *5  | Sys.ServoPeriod          | Set the value calculated as follows.<br>Sys.ServoPeriod<br>= 1000 * (Gate3[0].ServoClockDiv + 1) / Gate3[0].PhaseFreq                                                                                                                                                                                                                                                                                      |
| *6  | Gate3[x].PhaseServoDir   | Specify the unit that supplies the phase clock and the servo clock.                                                                                                                                                                                                                                                                                                                                        |

## 4-2 MotionOnTheFly.pmh

This file contains the settings for the MOTF.

| No. | Parameter                                  | Description                                                                                                                                                                                                                                                                                         |
|-----|--------------------------------------------|-----------------------------------------------------------------------------------------------------------------------------------------------------------------------------------------------------------------------------------------------------------------------------------------------------|
| *1  | KdgainX                                    | Specify the filter's coefficient to use for the MOTF for the X axis. The smaller this value, the larger the operating range of Galvo Scanner. A higher-speed response can be made by setting this value to such a small value as can make the most of the range that the Galvo Scanner can control. |
| *2  | KdgainY                                    | Specify the above filter's coefficient for the Y axis.                                                                                                                                                                                                                                              |
| *3  | GalvoSfX                                   | Specify the galvano motor command position (bit) relative to the travel distance of the laser along the X axis (in the command unit system). (Unit: bit/command unit)                                                                                                                               |
| *4  | GalvoSfY                                   | Specify the above value for the Y axis.                                                                                                                                                                                                                                                             |
| *5  | &1<br>#1-> ;<br>#2-> ;<br>#3-> ;<br>#4-> ; | Axes 1, 2, 3, and 4 are assigned to coordinate system 1 as inverse kinematics axes. To change the axis numbers or assign other axes to the coordinate system, add this block.                                                                                                                       |

## 4-3 MotorControl.pmh

This file contains the settings for linear motor control.

| No. | Parameter                     | Description                                                                                                                                                                                                                                                                                                                                                                                                                                                                                                                                                                                                                                              |
|-----|-------------------------------|----------------------------------------------------------------------------------------------------------------------------------------------------------------------------------------------------------------------------------------------------------------------------------------------------------------------------------------------------------------------------------------------------------------------------------------------------------------------------------------------------------------------------------------------------------------------------------------------------------------------------------------------------------|
| *1  | Motor[x].ServoCtrl            | For axis x that uses servo control, set this to 1. In this manual, six axes are used. However, to use more axes, also set Motor[y].ServoCtrl (y > 6) to 1.                                                                                                                                                                                                                                                                                                                                                                                                                                                                                               |
| *2  | Motor[x].pEnc, Motor[x].pEnc2 | Specify the encoder table to be referenced in loop feedback for axis x. In this manual, the encoder table with the same index as the axis is assigned.                                                                                                                                                                                                                                                                                                                                                                                                                                                                                                   |
| *3  | Motor[x].EncType              | Specify the encoder type for axis x. In this document, 6 is specified to use a sinusoidal encoder.                                                                                                                                                                                                                                                                                                                                                                                                                                                                                                                                                       |
| *4  | Motor[x].PosUnit              | Specify the command unit for axis x. In this manual, this is set to 3 to use mm as the unit.                                                                                                                                                                                                                                                                                                                                                                                                                                                                                                                                                             |
| *5  | EncTable[x].Type              | Specify the calculation method for each encoder table. In this manual, this is set to 1 to read 32-bit feedback values.                                                                                                                                                                                                                                                                                                                                                                                                                                                                                                                                  |
| *6  | EncTable[x].pEnc              | Specify the register to be referenced by encoder table x. In this manual, feedback values that are calculated by the CK3W-AX2323N Unit are obtained.                                                                                                                                                                                                                                                                                                                                                                                                                                                                                                     |
| *7  | EncTable[x].ScaleFactor       | Specify $1/2^8$ as the conversion factor to obtain 24-bit data from the CK3W-AX2323N Unit in each 32-bit encoder table.                                                                                                                                                                                                                                                                                                                                                                                                                                                                                                                                  |
| *8  | Motor[x].AmpFaultlevel        | Set whether to set the amplifier fault level to High active or Low active. In this manual, this is set to High active.                                                                                                                                                                                                                                                                                                                                                                                                                                                                                                                                   |
| *9  | Motor[x].FatalFeLimit         | Specify the amount of following error that stops operation at the axis x. To improve safety, set a smaller value. Contrarily, if any following error prevents operation from starting, set a larger value.                                                                                                                                                                                                                                                                                                                                                                                                                                               |
| *10 | Motor[x].PhaseCtrl            | For axis x that use a current loop, set this to 4. In this manual, the Direct PWM control method is used for the XY stage. However, to use analog voltage control or EtherCAT control, set this to 0.                                                                                                                                                                                                                                                                                                                                                                                                                                                    |
| *11 | Motor[x].pPhaseEnc            | Specify the register from which to obtain the feedback position of each motor.                                                                                                                                                                                                                                                                                                                                                                                                                                                                                                                                                                           |
| *12 | Motor[x].PhasePosSf           | Specify the conversion factor to convert the current position obtained in No. 11 into an electrical angle (0 to 2048). Specifically, this is calculated based on the following formula.<br>$\text{PhasePosSf} = \frac{2048 \times A}{B}$<br>Here, A represents the length per pulse of Gate3[0].Chan[x].Phase-Capt. It is 0.02/16384 since one cycle of a sine wave is 0.02 mm for the LIDA48 and the number of divisions of interpolation is 16384 for the PMAC.<br><br>Also, B represents the length per rotation of the motor in electrical angle. It is 36 since the ECL (Electrical Cycle Length) of the linear motor used in this manual is 36 mm. |
| *13 | Motor[x].PhaseOffset          | Specify the phase difference in the electrical angle (0 to 2048) of each phase motor. For a three-phase motor, set this to 683 or -683.                                                                                                                                                                                                                                                                                                                                                                                                                                                                                                                  |
| *14 | Motor[x].pAdc                 | Specify the register in which to read feedback current values from the servo amplifier. In this manual, the feedback values read from the Direct PWM interface are used.                                                                                                                                                                                                                                                                                                                                                                                                                                                                                 |



| No. | Parameter                 | Description                                                                                                                                                                                                                                                                                                                                                                                                                                                                                                                                                                                                   |
|-----|---------------------------|---------------------------------------------------------------------------------------------------------------------------------------------------------------------------------------------------------------------------------------------------------------------------------------------------------------------------------------------------------------------------------------------------------------------------------------------------------------------------------------------------------------------------------------------------------------------------------------------------------------|
| *15 | Motor[x].AdcMask          | Specify which bits of the register in No. 14 you want to use for feedback values. Set this value according to the specifications of the AD converter for reading current values that is installed in the servo amplifier.                                                                                                                                                                                                                                                                                                                                                                                     |
| *16 | Motor[x].pDac             | Specify the start address of the register to which to write the command output of the Controller. Here, the U-phase (Gate3[0].Chan[0].Pwm[0]) at the start of the register is specified since the register of the CK3W-AX2323N for U-, V-, or W-phase output is the output destination.                                                                                                                                                                                                                                                                                                                       |
| *17 | Motor[x].PhaseFindingDac  | Specify the output volume during phase reference search. If phase reference search is not completed, increase the value of this parameter since the output volume may be insufficient. Also, if an I2TFault status error occurs during phase reference search, decrease the value since the output current has exceeded the rated value.                                                                                                                                                                                                                                                                      |
| *18 | Motor[x].PhaseFindingTime | Specify the duration of time in phase reference search. If phase reference search is not completed, increase the value of this parameter. Also, if an I2TFault status error occurs during phase reference search, decrease the value since the output current has exceeded the rated value.                                                                                                                                                                                                                                                                                                                   |
| *19 | Motor[x].PwmSf            | Specify the coefficient of Direct PWM output. The full range is 16384. This is normally set to less than 95% of the full range so that the duty cycle of the PWM waveform does not reach 100%.<br><br>Set the parameter value according to the specifications of the servo amplifier in use.                                                                                                                                                                                                                                                                                                                  |
| *20 | Motor[x].MaxDac           | Specify the rated continuous current value of each motor and the servo amplifier. This is calculated based on the following formula.<br><br>$\text{MaxDac} = \frac{\cos 30^\circ \times 32,767 \times \text{Rated continuous current}}{\text{Full range of feedback current}}$<br>Here, the rated continuous current of the servo amplifier is used since it is smaller than that of the motors used for both the X and Y axes.<br>CK3A-G310L: 20A rms<br>INC-5716D0-0S: 9.88 A rms<br>INC-5723D0-0S: 14.82 A rms<br>The full range of feedback current is 31.35 Arms based on the CK3A-G310L specifications. |
| *21 | Motor[x].I2tSet           | Specify the rated short-time current value of each motor and the servo amplifier. This is calculated based on the following formula.<br><br>$\text{I2tSet} = \frac{\cos 30^\circ \times 32,767 \times \text{Rated short-time current}}{\text{Full range of feedback current}}$<br>Here, the short-time rated current of the servo amplifier is used since it is smaller than that of motors used for both the X and Y axes.<br>CK3A-G310L: 10A rms<br>INC-5716D0-0S: 3.08 A rms<br>INC-5723D0-0S: 4.62 A rms                                                                                                  |

| No. | Parameter                       | Description                                                                                                                                                                                                                                                                                                                          |
|-----|---------------------------------|--------------------------------------------------------------------------------------------------------------------------------------------------------------------------------------------------------------------------------------------------------------------------------------------------------------------------------------|
| *22 | Motor[x].I2tTrip                | Specify the allowable time for the short-time rated current value of the motor and servo amplifier. Please calculate the time using the following formula. The allowable time is 2 seconds according to the CK3A-G310L specifications.<br>$I2tTrip = (\text{MaxDac}^2 + \text{IdCmd}^2 - I2tSet^2) \times \text{Allowable time (s)}$ |
| *23 | Gate3[0].Chan[x].PwmDeadTime    | Specify the dead time of the PWM signal to 3 microseconds. Calculate the dead time using the following formula.<br>$\text{DeadTime} = 0.0533 \mu\text{s} \times \text{Gate3[0].Chan[x].PwmDeadTime}$ Set this value according to the specifications of the servo amplifier.                                                          |
| *24 | Gate3[0].Chan[x].PwmFreqMult    | Set the PWM output frequency to 15 kHz. The PWM output frequency is calculated by the following formula.<br>$f_{\text{PWM}} = \frac{\text{PwmFreqMult} + 1}{2} \times \text{Phase frequency}$<br>Set the PWM frequency to 40 kHz or less according to the maximum input frequency of the servo amplifier.                            |
| *25 | Gate3[0].Chan[x].PackOutData    | Enable the compression format to realize a highly efficient algorithm that completes writing to the output register for the U, V, or W phase in two times.<br><br>If you use the CK3W-AX2323N, do not change this value.                                                                                                             |
| *26 | Gate3[0].AdcAmpStrobe           | Specify the ADC strobe word (control command sent from the Controller to the servo amplifier according to the Direct PWM standards). Change this value according to the specifications of the servo amplifier.                                                                                                                       |
| *27 | Gate3[0].AdcAmpHeaderBits       | Specify the number of header bits included in feedback current value data. Change this value according to the specifications of the servo amplifier.                                                                                                                                                                                 |
| *28 | Gate3[0].AdcAmpClockDiv         | Specify the clock signal frequency of the AD converter that reads current data in the servo amplifier.                                                                                                                                                                                                                               |
| *29 | Gate3[0].Chan[x].PackInData     | Enable the compression format to realize a highly efficient algorithm that completes reading from the input register for the U, V, or W phase in two times.<br><br>If you use the CK3W-AX2323N, do not change this value.                                                                                                            |
| *30 | Gate3[0].Chan[x].AtanEna        | Enable this when using a sinusoidal encoder. Set 0 when using a digital quadrature encoder or serial encoder.                                                                                                                                                                                                                        |
| *31 | Gate3[0].Chan[x].EncCtrl        | Set the decoding method of the encoder. In this manual, quadruple AB-phase CW decoding is set.                                                                                                                                                                                                                                       |
| *32 | Motor[x].PosSf, Motor[x].Pos2Sf | Specify the conversion factor between the feedback value calculated by the Axis Interface Unit and the command position.<br>This is set to 0.020/16384 since the pulse count per cycle is 16384 when a sinusoidal encoder is used and one cycle is 0.020 mm for the sinusoidal encoder.                                              |

## 4-4 SensorControl.pmh

---

This file contains the settings for overtravel limit switches.

| No. | Parameter          | Description                                                                                     |
|-----|--------------------|-------------------------------------------------------------------------------------------------|
| *1  | Motor[x].pLimits   | Specify the register to be referenced by the overtravel limit switch.                           |
| *2  | Motor[x].LimitBits | Specify which bits of the register (No. 1) are to be referenced by the overtravel limit switch. |

## 4-5 Galvano.pmh

This file contains the settings for controlling the Galvo Scanner.

| No. | Parameter               | Description                                                                                                                                                                                                            |
|-----|-------------------------|------------------------------------------------------------------------------------------------------------------------------------------------------------------------------------------------------------------------|
| *1  | Gate3[1].SerialEncCtrl  | Set this according to the figure below.                                                                                                                                                                                |
| *2  | Motor[x].ServoCtrl      | For axis x that uses servo control, set this to 1. In this manual, six axes are used. However, to use more axes, also set Motor[y].ServoCtrl (y > 6) to 1.                                                             |
| *3  | Motor[x].Ctrl           | For galvano control, set this to Sys.PosCtrl since it performs position control.                                                                                                                                       |
| *4  | Motor[x].MaxSpeed       | Specify the maximum velocity of galvano control. This time, specify 0 to disable the maximum velocity monitor.                                                                                                         |
| *5  | Motor[x].MaxPos         | Specify the maximum value of the command position for galvano control. This time, specify 0 to disable it.                                                                                                             |
| *6  | Motor[x].MinPos         | Specify the minimum value of the command position for galvano control. This time, specify 0 to disable it.                                                                                                             |
| *7  | Motor[x].pDac           | Specify the start address of the register to which to write the command output of the Controller. Here, specify Gate3[1].Chan[x].Dac[0] since the register of the CK3W-GC2200 for XY output is the output destination. |
| *8  | Motor[x].pLimits        | Set the overtravel limit of galvano control. This time, specify 0 to disable it.                                                                                                                                       |
| *9  | Motor[x].FatalFeLimit   | Specify the amount of following error that stops operation at the axis x. Specify 0 because Galvo Scanner disables this setting.                                                                                       |
| *10 | Motor[x].pEnc           | Specify the encoder table to be referenced in position loop feedback for axis x. In this manual, the encoder table with the same index as the axis is assigned.                                                        |
| *11 | Motor[x].pEnc2          | Specify the encoder table to be referenced in velocity loop feedback for axis x. In this manual, the encoder table with the same index as the axis is assigned.                                                        |
| *12 | EncTable[x].Type        | Specify the calculation method for each encoder table. In this manual, this is set to 1 to read 32-bit feedback values.                                                                                                |
| *13 | EncTable[x].pEnc        | Specify the register to be referenced by encoder table x. In this manual, the linear interpolation values calculated by the CK3W-GC2200 Unit are output.                                                               |
| *14 | EncTable[x].ScaleFactor | Specify $1/2^{12}$ as the conversion factor to obtain 20-bit SL2-100 data in each 32-bit encoder table.                                                                                                                |

|          |  |  |  |  |  |  |  |  |  |  |  |    |    |   |                      |   |   |                   |   |   |   |   |   |
|----------|--|--|--|--|--|--|--|--|--|--|--|----|----|---|----------------------|---|---|-------------------|---|---|---|---|---|
| Reserved |  |  |  |  |  |  |  |  |  |  |  | 11 | 10 | 9 | 8                    | 7 | 6 | 5                 | 4 | 3 | 2 | 1 | 0 |
| Reserved |  |  |  |  |  |  |  |  |  |  |  | 1  | 0  | 0 | 0                    | 0 | 0 | 0                 | 0 | 0 | 0 | 0 | 0 |
| Reserved |  |  |  |  |  |  |  |  |  |  |  | 8  |    |   | 0                    |   | 0 |                   |   |   |   |   |   |
| Reserved |  |  |  |  |  |  |  |  |  |  |  | 1  |    |   | Validate Tx data     |   |   | Rising Edge       |   |   |   |   |   |
| Reserved |  |  |  |  |  |  |  |  |  |  |  | 2  |    |   | Command Position     |   |   | Asynchronous Mode |   |   |   |   |   |
| Reserved |  |  |  |  |  |  |  |  |  |  |  | 8  |    |   | Phase Clock          |   |   | TXEnable          |   |   |   |   |   |
| Reserved |  |  |  |  |  |  |  |  |  |  |  | 1  |    |   | Enable TX of SL2-100 |   |   | TXEnable          |   |   |   |   |   |

For Command Position

|          |  |  |  |  |  |  |  |  |  |  |  |    |    |   |                      |   |   |                   |   |   |   |   |   |
|----------|--|--|--|--|--|--|--|--|--|--|--|----|----|---|----------------------|---|---|-------------------|---|---|---|---|---|
| Reserved |  |  |  |  |  |  |  |  |  |  |  | 11 | 10 | 9 | 8                    | 7 | 6 | 5                 | 4 | 3 | 2 | 1 | 0 |
| Reserved |  |  |  |  |  |  |  |  |  |  |  | 1  | 0  | 0 | 0                    | 0 | 0 | 0                 | 0 | 0 | 0 | 0 | 0 |
| Reserved |  |  |  |  |  |  |  |  |  |  |  | 8  |    |   | 0                    |   | 0 |                   |   |   |   |   |   |
| Reserved |  |  |  |  |  |  |  |  |  |  |  | 1  |    |   | Validate Tx data     |   |   | Rising Edge       |   |   |   |   |   |
| Reserved |  |  |  |  |  |  |  |  |  |  |  | E  |    |   | Control Commands     |   |   | Asynchronous Mode |   |   |   |   |   |
| Reserved |  |  |  |  |  |  |  |  |  |  |  | 8  |    |   | Phase Clock          |   |   | TXEnable          |   |   |   |   |   |
| Reserved |  |  |  |  |  |  |  |  |  |  |  | 1  |    |   | Enable TX of SL2-100 |   |   | TXEnable          |   |   |   |   |   |

For Control Commands

# 4-6 LaserControl.pmh

This file contains the settings for controlling the laser oscillator.

| No. | Parameter              | Description                                                                                                            |
|-----|------------------------|------------------------------------------------------------------------------------------------------------------------|
| *1  | Gate3[1].Chan[0].CompA | Set this according to the figures below.                                                                               |
| *2  | Gate3[1].Chan[1].CompA | Set the delay time of SL2-100 communications data to the internal clock of the PMAC. In this manual, this is set to 0. |
| *3  | Gate3[1].Chan[2].CompA | Set this according to the figures below.                                                                               |

|                  |    |    |    |    |    |    |    |    |    |    |    |                        |    |    |    |    |    |    |    |          |    |   |   |   |   |   |   |   |   |   |   |
|------------------|----|----|----|----|----|----|----|----|----|----|----|------------------------|----|----|----|----|----|----|----|----------|----|---|---|---|---|---|---|---|---|---|---|
| DutyCycle        |    |    |    |    |    |    |    |    |    |    |    | PWMPeriod              |    |    |    |    |    |    |    | Reserved |    |   |   |   |   |   |   |   |   |   |   |
| 31               | 30 | 29 | 28 | 27 | 26 | 25 | 24 | 23 | 22 | 21 | 20 | 19                     | 18 | 17 | 16 | 15 | 14 | 13 | 12 | 11       | 10 | 9 | 8 | 7 | 6 | 5 | 4 | 3 | 2 | 1 | 0 |
| 1                | 0  | 0  | 0  | 0  | 0  | 0  | 0  | 0  | 0  | 0  | 0  | 0                      | 0  | 0  | 0  | 1  | 1  | 0  | 1  | 0        | 0  | 0 | 0 | 0 | 0 | 0 | 0 | 0 | 0 | 0 | 0 |
| 8                |    |    |    | 0  |    |    |    | 0  |    |    |    | 0                      |    |    |    | D  |    |    |    | 0        |    |   |   | 0 |   |   |   | 0 |   |   |   |
| Duty Ratio = 50% |    |    |    |    |    |    |    |    |    |    |    | PWM Frequency = 30 KHz |    |    |    |    |    |    |    | 1        |    |   |   |   |   |   |   |   |   |   |   |

Settings of Gate3[1].Chan[0].CompA

|          |    |    |    |    |    |    |    |    |    |    |    |                          |    |    |    |    |    |    |    |          |    |   |   |   |   |   |   |   |   |   |   |
|----------|----|----|----|----|----|----|----|----|----|----|----|--------------------------|----|----|----|----|----|----|----|----------|----|---|---|---|---|---|---|---|---|---|---|
| Reserved |    |    |    |    |    |    |    |    |    |    |    | PulseCount               |    |    |    |    |    |    |    | Reserved |    |   |   |   |   |   |   |   |   |   |   |
| 31       | 30 | 29 | 28 | 27 | 26 | 25 | 24 | 23 | 22 | 21 | 20 | 19                       | 18 | 17 | 16 | 15 | 14 | 13 | 12 | 11       | 10 | 9 | 8 | 7 | 6 | 5 | 4 | 3 | 2 | 1 | 0 |
| 0        | 0  | 0  | 0  | 0  | 0  | 0  | 0  | 0  | 0  | 0  | 0  | 1                        | 1  | 1  | 1  | 1  | 1  | 1  | 1  | 1        | 1  | 1 | 1 | 0 | 0 | 0 | 0 | 0 | 0 | 0 | 0 |
| 0        |    |    |    | 0  |    |    |    | 0  |    |    |    | F                        |    |    |    | F  |    |    |    | F        |    |   |   | 0 |   |   |   | 0 |   |   |   |
| Reserved |    |    |    |    |    |    |    |    |    |    |    | Continuous Pulse Outputs |    |    |    |    |    |    |    | Reserved |    |   |   |   |   |   |   |   |   |   |   |

Settings of Gate3[1].Chan[2].CompA

# 4-7 TCRConfigurations.pmh

This file contains the condition settings for turning ON/OFF the laser.

| No. | Parameter              | Description                                                                                                                 |
|-----|------------------------|-----------------------------------------------------------------------------------------------------------------------------|
| *1  | Gate3[1].Chan[1].CompB | Set the travel distance before the laser turns from OFF to ON.                                                              |
| *2  | Gate3[1].Chan[1].CompB | Set the travel distance before the laser turns from ON to OFF.<br>After this, add the condition to toggle the laser output. |
| *3  | Gate3[1].Chan[2].CompB | Set this according to the figures below.                                                                                    |

The figure bellow illustrates the condition used in this manual, where laser light is output at home, travels around the square, and returns to the home again.

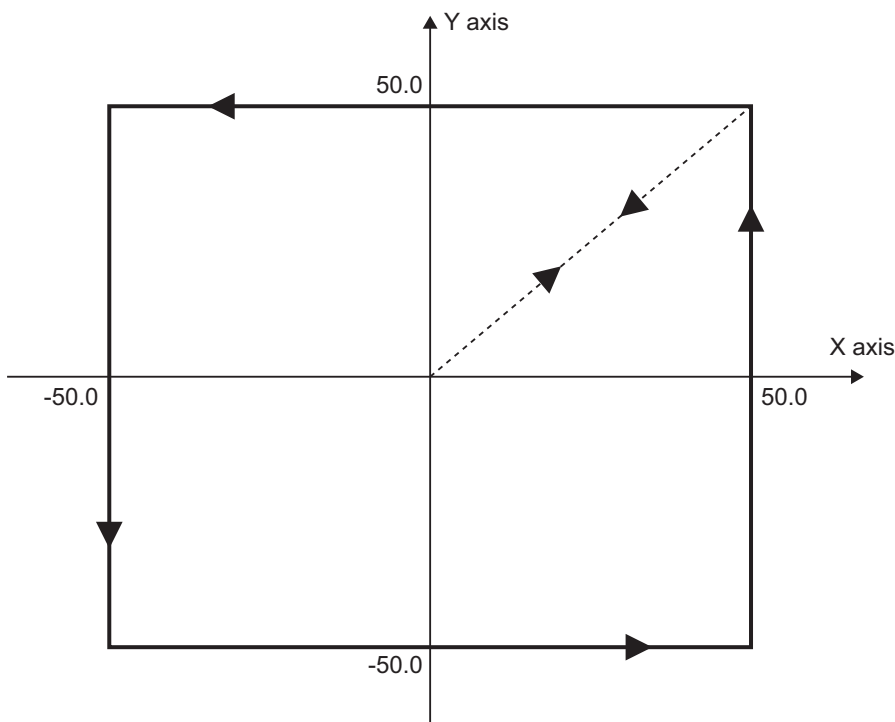

|                 |            |             |          |              |            |          |    |    |    |    |    |    |    |    |    |    |    |    |    |    |    |    |    |    |    |    |    |   |   |   |   |   |   |
|-----------------|------------|-------------|----------|--------------|------------|----------|----|----|----|----|----|----|----|----|----|----|----|----|----|----|----|----|----|----|----|----|----|---|---|---|---|---|---|
| CompareEnable   | ClearTable | CompClkSel  | Reserved | CompOutWrite | CompOutPol | Reserved |    |    |    |    |    |    |    |    |    |    |    |    |    |    |    |    |    |    |    |    |    |   |   |   |   |   |   |
|                 |            |             |          |              |            | 31       | 30 | 29 | 28 | 27 | 26 | 25 | 24 | 23 | 22 | 21 | 20 | 19 | 18 | 17 | 16 | 15 | 14 | 13 | 12 | 11 | 10 | 9 | 8 | 7 | 6 | 5 | 4 |
| 1               | 0          | 0           | 0        | 0            | 0          | 0        | 0  | 0  | 0  | 0  | 0  | 0  | 0  | 0  | 0  | 0  | 0  | 0  | 0  | 0  | 0  | 0  | 0  | 0  | 0  | 0  | 0  | 0 | 0 | 0 | 0 | 0 | 0 |
| 8               |            |             | 0        |              |            | 0        |    |    | 0  |    |    | 0  |    |    | 0  |    |    | 0  |    |    | 0  |    |    |    |    |    |    |   |   |   |   |   |   |
| Compare Enabled | Normal     | Servo Clock | -        | Normal       | H active   | -        |    |    |    |    |    |    |    |    |    |    |    |    |    |    |    |    |    |    |    |    |    |   |   |   |   |   |   |
|                 |            |             |          |              |            |          |    |    |    |    |    |    |    |    |    |    |    |    |    |    |    |    |    |    |    |    |    |   |   |   |   |   |   |

Settings of Gate3[1].Chan[2].CompB







**OMRON Corporation Industrial Automation Company**

**Kyoto, JAPAN**

**Contact : [www.ia.omron.com](http://www.ia.omron.com)**

**Regional Headquarters**

**OMRON EUROPE B.V.**

Wegalaan 67-69, 2132 JD Hoofddorp  
The Netherlands

Tel: (31) 2356-81-300 Fax: (31) 2356-81-388

**OMRON ASIA PACIFIC PTE. LTD.**

438B Alexandra Road, #08-01/02 Alexandra  
Technopark, Singapore 119968

Tel: (65) 6835-3011 Fax: (65) 6835-2711

**OMRON ELECTRONICS LLC**

2895 Greenspoint Parkway, Suite 200  
Hoffman Estates, IL 60169 U.S.A.

Tel: (1) 847-843-7900 Fax: (1) 847-843-7787

**OMRON (CHINA) CO., LTD.**

Room 2211, Bank of China Tower,  
200 Yin Cheng Zhong Road,  
PuDong New Area, Shanghai, 200120, China

Tel: (86) 21-5037-2222 Fax: (86) 21-5037-2200

**Authorized Distributor:**

©OMRON Corporation 2021 - 2023 All Rights Reserved.  
In the interest of product improvement,  
specifications are subject to change without notice.

**Cat. No. 0052-E1-02 0123**