

OMRON

V780-HMD68-ETN-CN-S

UHF RFID System Reader/Writer

UHF RFID读写器

Instruction Sheet

使用说明书

This instruction sheet primarily provides precautions required in installing and operating the product. Before installing or operating the product, read this instruction sheet thoroughly to acquire sufficient knowledge of the product.

For your convenience, keep this instruction sheet where it will be available when needed.

• For detailed information, refer to the *user's manual* (Cat. No. Z389-E1).

本说明书主要介绍安装和操作本产品时的注意事项。安装或操作本产品之前，请通读本说明书以掌握足够的产品知识。为了您的方便，请将本说明书保存在需要时可获取的位置。

- 有关详细信息，请参阅用户手册（手册编号 Z389-E1）。



欧姆龙公司

© OMRON Corporation 2019 All Rights Reserved.

PRECAUTIONS ON SAFETY/安全注意事项

● Meaning of Signal Words/ 信号词含义



Indicates a potentially hazardous situation which, if not avoided, will result in minor or moderate injury, or may result in serious injury or death. Additionally there may be significant property damage.



表示若不可避免，将会导致轻微或中度人身伤害，或者可能导致严重人身伤害或死亡的潜在危险情况。还可能导致重大财产损失。

● 警报声明



The V780-HMD68-ETN-CN-S can be used only in China. V780-HMD68-ETN-CN-S不可在中华人民共和国境外使用。



An expert well versed in safety measures should be asked to perform the Reader/Writer installations in high locations. 应聘请深谙安全措施的专家在高处安装读写器。



Injury may occur if the Reader/Writer falls and strikes a person. Observe the following precautions when installing the Reader/Writer.



- Do not install if there are persons below the product.
- Observe the recommended tightening torque for bolts.

若读写器掉落并砸到人，则可能会导致人身伤害。安装读写器时，请遵循以下注意事项。

- 请勿在产品下有人时安装。
- 请遵循螺栓的建议紧固扭矩。

PRECAUTIONS FOR SAFE USE

Observe the following precautions to ensure safety.

- Transportation
 - The Reader/Writer may be damaged if it falls from a high location. When you transport Reader/Writers, do not stack them too high.
 - Injury may occur if the Reader/Writer falls. Do not let the Reader/Writer fall when you carry it.
- Installation and Removal
 - Use slip-resistant gloves when you install the Reader/Writer and hold the Reader/Writer securely at the depressions with both hands.
- Wiring
 - The Reader/Writer may be damaged. Wire it correctly.
 - The Reader/Writer may be destroyed. Do not exceed the rated voltage range.
 - The cables may break. Confirm cable specifications and do not bend cables past their normal bending radius.
 - The Reader/Writer may be damaged. Never use an AC power supply.
 - Connect the Ethernet cable to a host device (e.g., Switching Hub or PLC) that supports STP and ground the host device to a ground resistance of 100 Ω or less.
- Usage
 - The communications range depends on the operating and installation environment. Use the Reader/Writer only after sufficiently testing operation onsite.
 - If multiple Reader/Writers are installed near each other, communications distances may decrease due to mutual interference. Refer to *Reader/Writer Mutual Interference (Reference Data) in the appendices to the user's manual (Cat. No. Z389-E1)* and check to make sure there is no mutual interference between Reader/Writers.
- Errors and Failures
 - If an error is detected in the Reader/Writer, immediately stop operation and turn OFF the power supply. Consult with an OMRON representative.
- Maintenance
 - Using thinner, benzene, acetone, or kerosene may adversely affect the plastic parts and case coating. Refer to *Chemical Resistance of the Reader/Writer in the appendices to the user's manual (Cat. No. Z389-E1)* and do not use chemicals that would have a negative effect.
- Disposal
 - Dispose of the Reader/Writer as industrial waste.

PRECAUTIONS FOR CORRECT USE

Always observe the following precautions to prevent operation failures, malfunctions, and adverse effects on the Reader/Writer.

- Transportation
 - Always use the packing box that comes with the Reader/Writer when you transport it, and do not subject it to excessive vibration or shock.
- Installation
 - After you tighten the bolts, make sure that the Reader/Writer is securely attached.
- Installation and Storage Environment
 - Do not use or store the Reader/Writer in the following locations.
 - Locations subject to combustible gases, explosive gases, corrosive gases, dust, dirt, metal powder, salt, or oil
 - Locations where the specified ambient temperature or ambient humidity range is exceeded
 - Locations subject to extreme temperature changes that may result in condensation
 - Locations where the Reader/Writer would be directly subjected to vibration or shock exceeding specifications
 - Locations subject to water exposure that exceeds the specifications
- Storage Methods
 - Injury or damage may occur if the Reader/Writer falls. Implement safety measures so that the Reader/Writer will not fall.
- Wiring
 - To use the Reader/Writer in RUN mode, connect the control signal to the +24V of the power supply. If you connect the control signal to the 0-V side of the power supply, the Reader/Writer will start in Safe Mode.
- Usage
 - The Reader/Writer may fail if it is used with a damaged cable. Do not subject the cable to strong forces or place heavy objects on the cable.
 - Observe the tightening torque specifications for the power supply and communications connectors.
 - The Reader/Writer may fail if heat cannot be dissipated sufficiently. Ensure that heat can be dissipated around the Reader/Writer.
 - Do not use the Reader/Writer outdoors.
 - Do not attempt to disassemble, repair, or modify the Reader/Writer.
- Maintenance
 - Perform inspections both daily and periodically.
 - The Reader/Writer may fail if it or its wiring is replaced while the power supply is ON. Always turn OFF the power supply before you replace the Reader/Writer or its wiring.

安全使用注意事项

请遵循以下注意事项以确保安全。

- 运输
 - 从高处掉落可能会损坏读写器。运输读写器时，请勿堆放过高。
 - 读写器掉落可能会导致人身伤害。搬运读写器时，请勿让其掉落。
- 安装和拆卸
 - 安装读写器时，请佩戴防滑手套并用双手牢固按住读写器固定。
- 配线
 - 读写器可能会被损坏。请正确配线。
 - 读写器可能会被破坏。请勿超出额定电压范围。
 - 电缆可能被损坏。请确认电缆规格，并且请勿弯曲电缆使其超过其正常弯曲半径。
 - 读写器可能会被损坏。切勿使用AC电源。
 - 请将以太网电缆连接至支持STP的主机设备（例如交换集线器或PLC），并将主机设备接地至100 Ω或以下。
- 使用
 - 通信范围取决于操作和安装环境。请仅在现场充分执行测试操作后，再使用读写器。
 - 如果多个读写器安装在互相附近，通信距离可能会由于互相干扰而缩短。请参阅用户手册（手册编号 Z389-E1）附件《读写器互相干扰（参考数据）》，并检查以确保读写器之间没有互相干扰。
- 错误和故障
 - 若检测到读写器中有错误，请立即停止操作并关闭电源。请咨询欧姆龙代表。
- 维护
 - 使用稀释剂、苯、丙酮或煤油可能会对塑料部件和外壳涂层产生不利影响。
 - 请参阅用户手册（手册编号 Z389-E1）附件《读写器的耐化学性》，并且请勿使用可能会造成负面影响的化学品。
- 处置
 - 请将读写器作为工业废弃物处置。

正确使用注意事项

务必遵循以下注意事项以防止操作失败、故障以及有关读写器的不利影响。

- 运输
 - 运输读写器时务必使用随附的包装箱，并避免过度振动或冲击。
- 安装
 - 紧固螺栓后，确保读写器已牢固安装。
- 安装和存储环境
 - 请勿在以下位置使用或存储读写器。
 - 存在可燃气体、爆炸性气体、腐蚀性气体、灰尘、污垢、金属粉末、盐或油的位置
 - 超出指定环境温度或湿度范围的位置
 - 存在极端温度变化，可能会导致冷凝的位置
 - 读写器将直接受到超出规格的振动和冲击的位置
 - 含水超出规格的位置
- 存储方法
 - 读写器掉落可能会导致人身伤害或损坏。请采取安全措施，以防读写器掉落。
- 配线
 - 要在运行模式下使用读写器，请将控制信号连接至+24V电源。若将控制信号连接至电源的0-V侧，读写器将以安全模式启动。
- 使用
 - 如果桌面损坏，读写器可能会掉落。请勿强力拉扯电缆或在电缆上放置重物。
 - 请遵循电源和通信连接器的紧固扭矩规格。
 - 如果无法充分散热，读写器可能会掉落。确保读写器周围散热良好。
 - 请勿在户外使用读写器。
 - 请勿尝试拆卸、维修或修改读写器。
- 维护
 - 请每天并定期执行检查。
 - 若在电源开启时更换读写器或其配线，可能会导致读写器掉落。更换读写器或其配线之前，务必关闭电源。

1. Ratings and Performances/额定值和性能

■ V780-HMD68-ETN-CN-S

● General Specifications/一般规格

Item 项目	V780-HMD68-ETN-CN-S
Dimensions 尺寸	250 x 250 x 70 mm (W x H x D, excluding protruding parts and cables) 250 x 250 x 70 mm (W x H x D, 不包含凸出部件和电缆)
Supply voltage 电源电压	24 VDC (-15% to +10%) Class2 24 VDC (-15%至+10%) 2级
Power consumption 功耗	10 W max. 最大10 W
Ambient operating temperature 环境温度	-10 to 55°C (with no icing) -10°C至55°C (不结冰)
Ambient operating humidity 环境工作湿度	25% to 85% (with no condensation) 25%至85% (不冷凝)
Ambient storage temperature 环境存储温度	-25 to 70°C (with no icing) -25°C至70°C (不结冰)
Ambient storage humidity 环境存储湿度	25% to 85% (with no condensation) 25%至85% (不冷凝)
Insulation resistance 绝缘电阻	20 MΩ min. (at 500 VDC/mega) between cable terminals and case 最小20 MΩ (500 VDC情况下)，电缆终端和外壳之间
Dielectric strength 介电强度	1,000 VAC, 50/60 Hz for 1 min between cable terminals and case 1分钟1,000 VAC, 50/60 Hz, 电缆终端和外壳之间
Vibration resistance 抗振强度	No abnormality after application of 10 to 500 Hz, double amplitude: 1.5 mm, acceleration: 100 m/s ² , 10 sweeps in each of 3 axis directions (up/down, left/right, and forward/backward) for 11 minutes each 应用10 Hz至500 Hz之后无异常；双振幅：1.5 mm；加速度：100 m/s ² ，3个轴方向（上下、左右、前后）的每个轴方向10次扫描，每次11分钟
Shock resistance 抗冲击强度	No abnormality after application of 500 m/s ² , 3 times each in 6 directions (Total:18 times) 应用500 m/s ² ，6个方向每个方向3次（总计：18次后无异常）
Degree of protection 防护等级	IP54 (IEC 60529:2001)
Materials 材质	Plastic case: PBT Metal case: Die-cast aluminum (ADC12) 塑料外壳：PBT 金属外壳：压铸铝(ADC12)
Weight 重量	Approx. 3 kg 约3 kg
Mounting method 安装方法	Four M6 bolts 四个M6螺栓
Host communications interface 主机通信接口	Ethernet 10BASE-T/100BASE-TX 以太网10BASE-T/100BASE-TX
Host communications protocol 主机通信协议	Multi-Reader/Writer Function only*1 多读写器功能专用*1
Accessories 配件	Instruction Sheet (1), IP address label (1), and Startup Guide (1) 说明书(1)、IP地址标签(1)、启动手册(1)
Regulations 法规	信部无〔2007〕205号

*1. Communication is performed only via the master reader/writer (model V780-HMD68-ETN-CN). It can not be controlled from a host device such as PLC. But web server function is available.

*1. 仅可经由主读写器（型号V780-HMD68-ETN-CN）进行通信。无法从PLC等主机设备进行控制，但可以使用Web服务器功能。

2. Dimensions/尺寸

V780-HMD68-ETN-CN-S

(Unit: mm)
(单位：mm)

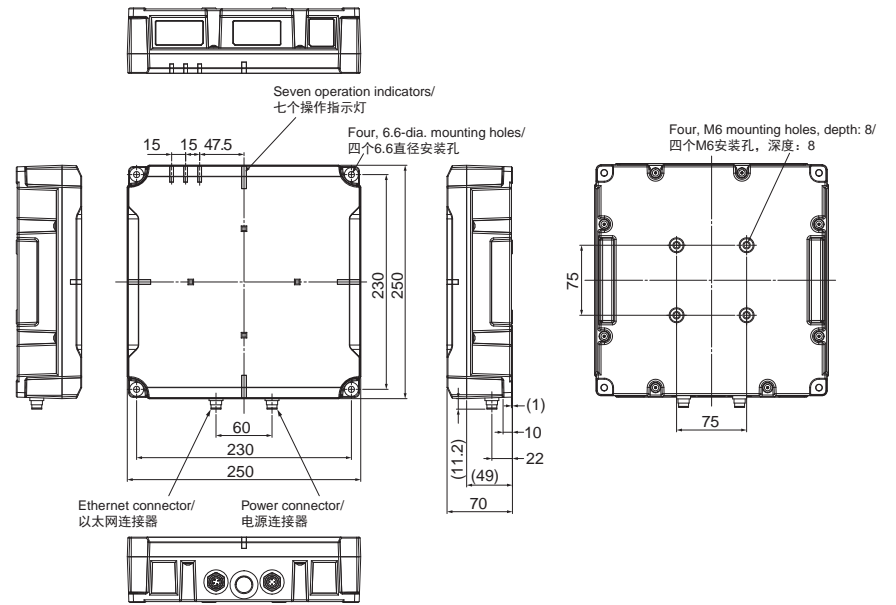

● Tag Communications Specifications/标签读写规格

Item 项目	V780-HMD68-ETN-CN-S
Applicable countries 适用国家/地区	China 中华人民共和国
Maximum Radiated power 最大辐射功率	2 W e.r.p
Output power 输出功率	15 to 27 dBm (Switchable in 1-dB increments.) 15 dBm至27 dBm (可以1-dB增量切换。)
Transmission speed from Reader/Writer to RF Tag 读写器到RF标签的发送速度	40 kbps (fixed) 40 kbps (固定)
Transmission speed from RF Tag to Reader/Writer RF标签到读写器的发送速度	• 80 kbps (High-speed Mode/高速模式) *1 • 20 kbps (Standard Mode/标准模式) *1
Used frequencies 适用频率	16 channels (920.625 to 924.375 MHz) 16信道 (920.625~924.375MHz) FHSS/FHSS方式
Communications method with RF Tags 与RF标签的通信方法	Miller-modulated subcarrier 编码调制副载波
Tag communications protocol 标签读写协议	ISO/IEC 18000-63: 2013 (EPCglobal Class-1 Generation-2) ISO/IEC 18000-63:2013 (EPCglobal 1级2代)
Polarization characteristic 偏正特性	RHCP

*1. The default setting is for Automatic Mode. The Reader/Writer will automatically change to High-speed Mode or Standard Mode depending on the interference waves.

*1. 默认设置为自动模式。读写器将根据干扰波自动切换为高速模式或标准模式。

● Recommended Power Supply (24 VDC)/建议电源 (24 VDC)

Item 项目	Condition 条件
Supply voltage 电源电压	24 VDC -15% to +10% 24 VDC -15%至+10%
Output current 输出电流	500 mA min. 最小500 mA
Safety standard 安全标准	SELV (Safety Extra Low Voltage) SELV (安全超低电压)

3. Installation/安装

Install the Reader/Writer with four M6 bolts. Use both spring washers and flat washers.

使用四个M6螺栓安装读写器。安装时要同时装上弹簧垫圈和平垫圈。

Recommended tightening torque: 4.3 N-m
建议紧固扭矩: 4.3 N-m

• Front Mounting/ 前部支架

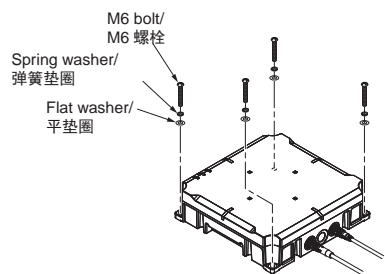

Mounting Hole Dimensions/
安装孔尺寸

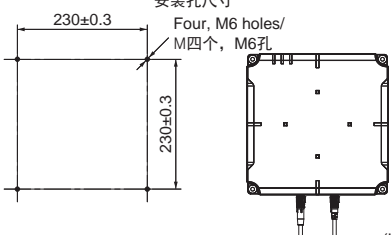

• Rear Mounting/ 后部支架 *1

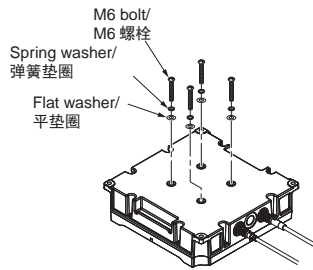

Mounting Hole Dimensions/
安装孔尺寸

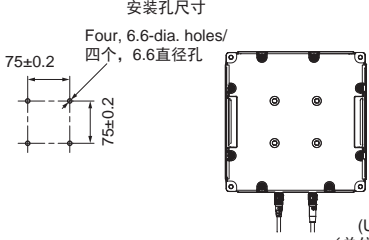

*1. An M6 bolt engagement length of 6 to 8 mm is necessary for rear mounting.

The bolts may be hard to tighten. Tighten them to the recommended tightening torque.

*1. 后部支架需要一个接合长度为6 mm至8 mm的M6螺栓。螺栓可能很难紧固。请将螺栓紧固至建议紧固扭矩。

4. Names and Functions of Operation Indicators/ 操作指示灯名称和功能

V780-HMD68-ETN-CN-S

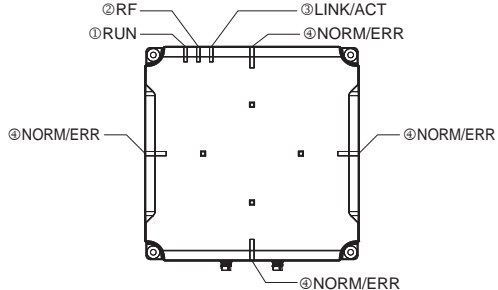

Number and name/ 数量和名称	Color/ 颜色	Status/ 状态	Description/ 描述
① RUN	Green/ 绿色	Flashing at 0.1-s intervals/ 以0.1秒间隔闪烁	Flashes quickly during startup. 启动时快速闪烁。
		Flashing at 0.4-s intervals/ 以0.4秒间隔闪烁	Flashes during operation in Safe Mode. 在安全模式下操作时闪烁。
	Lit/ 亮起	Lit during operation in Run Mode. 在运行模式下操作时亮起。	
	Yellow/ 黄色	Lit/ 亮起	Lit during operation in Slave Mode. 在从模式下操作时亮起。
	Cyan/ 青色	Lit/ 亮起	Lit during test operation. 测试操作时亮起。
② RF	Yellow/ 黄色	Lit/ 亮起	Lit when a radio wave is being output. (Lit during communications with RF Tag.) 无线电波输出时亮起。(与RF标签通信时亮起。)
		Not lit/ 不亮	Not lit when a radio wave is not being output. 无线电波不在输出时不亮。
③ LINK/ACT	Green/ 绿色	Lit/ 亮起	Lit when a link has been established on the Ethernet port. 在以太网端口上建立起链接时亮起。
		Flashing irregularly/ 不规则闪烁	Flashes during data communications on the Ethernet port. 在以太网端口上进行数据通信时闪烁。
		Not lit/ 不亮	Not lit when a link has not been established on the Ethernet port. 未在以太网端口上建立起链接时不亮。
④ NORM/ERR	Green/ 绿色	Lit for 0.2 s/ 亮0.2秒	Lights once when processing a communications command or another command from the host device is completed normally. 主机设备的通信命令或另一个命令处理完成后亮一次。
		Lit for 0.2 s/ 亮0.2秒	Lights once each time an unstable communication is detected while communications diagnosis is enabled. 在通信诊断启用的情况下, 每次检测到不稳定通信时闪烁一次。
	Yellow/ 黄色	Lit for 0.2 s/ 亮0.2秒	Lights once when processing a communications command or another command from the host device ends in an error. 主机设备的通信命令或另一个命令处理结果错误时亮一次。
	Red/ 红色	Lit/ 亮起	Lit when a major fault has occurred. (Lit when a fatal error has occurred.) 发生重大错误时亮起。(发生致命错误时亮起。)
		Flashing at 0.4-s intervals/ 以0.4秒间隔闪烁	Flashes when a minor fault has occurred. (Flashes when a nonfatal error has occurred.) 发生轻度错误时闪烁。(发生非致命错误时闪烁。)
Cyan/ 青色	Flashing at 0.1-s intervals/ 以0.1秒间隔闪烁	Flashes during installation location notification. 安装位置通知时闪烁。	
	Flashing once every 3 s/ 每3秒闪烁一次	Flashes during operation in the Focus Mode. 在焦点模式下操作时闪烁。	
		Not lit/ 不亮	Not lit when the Reader/Writer is on standby. 读写器处于待机状态时不亮。

5. Connecting and Disconnecting the Reader/Writer Power Cable and Ethernet Cable/ 连接和断开读写器电源电缆和以太网电缆

• Connecting the Cable/ 连接电缆

- Hold onto the connector on the Power Cable and insert it into the Reader/Writer power connector.
抓紧电源电缆上的连接器并将其插入读写器电源连接器。
- Turn the connector on the Power Cable clockwise to lock it in place.
顺时针旋转电源电缆上的连接器以将其锁定到位。
Turn the cable connector clockwise until you hear it securely lock in place.
顺时针旋转电缆连接器直至听见其牢固锁定到位。
- Hold onto the connector on the Ethernet Cable and insert it into the Reader/Writer Ethernet connector.
抓紧以太网电缆上的连接器并将其插入读写器以太网连接器。
- Turn the connector on the Ethernet Cable clockwise to lock it in place.
顺时针旋转以太网电缆上的连接器以将其锁定到位。
Turn the cable connector clockwise until you hear it securely lock in place.
顺时针旋转电缆连接器, 直至听见其牢固锁定到位。

Reader/Writer Power Connector/
读写器电源连接器

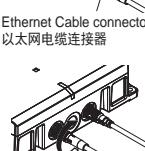
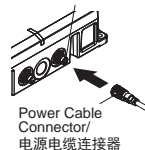

• Disconnecting the Cable/ 断开电缆

- Turn the connector on the Power Cable counterclockwise to unlock it.
逆时针旋转电源电缆上的连接器以解锁。
- Hold onto the connector on the Power Cable and pull it straight out to remove it.
抓住电源电缆上的连接器并将其直接拔出以移除。
- Turn the connector on the Ethernet Cable counterclockwise to unlock it.
逆时针旋转以太网电缆上的连接器以解锁。
- Hold onto the connector on the Ethernet Cable and pull it straight out to remove it.
抓住以太网电缆上的连接器并将其直接拔出以移除。

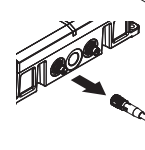
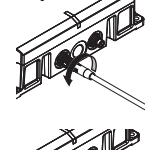
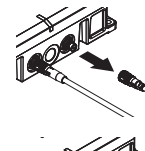
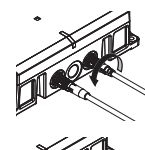

• Reader/Writer Ethernet connector/ 读写器以太网连接器

Appearance 外观	Size 大小	Opening shape 开口形状	Polarity 极性
	M12	Receptacle 插座型	Male 公

Pin No. 引脚号	Name 名称	Description 描述	I/O
1	TD+	Ethernet send + signal 以太网发送+信号	OUT
2	RD+	Ethernet receive + signal 以太网接收+信号	IN
3	TD-	Ethernet send - signal 以太网发送-信号	OUT
4	RD-	Ethernet receive - signal 以太网接收-信号	IN
Housing 外壳	FG	Frame ground 外壳接地	-

• Recommended Ethernet Cable (100 m max.)/ 推荐以太网电缆 (最大 100 m)

XS5W-T42□□ME-K (made by OMRON/欧姆龙制造)

• Reader/Writer Power Connector/ 读写器电源连接器

Appearance 外观	Size 大小	Opening shape 开口形状	Polarity 极性
	M12	Receptacle 插座型	Male 公

Pin No. 引脚号	Name 名称	Description 描述	I/O
1	24P	+24V	-
2	CONT	Control signal (operating mode signal) * Run Mode: Connect to 24 V and then start the Reader/Writer. Safe Mode: Connect to 0 V and then start the Reader/Writer. 控制信号 (动作模式信号) * 运行模式: 连接至 24 V, 然后启动读写器。 安全模式: 连接至 0 V, 然后启动读写器。	IN
3	24N	0V	-
4	-	-	-

• Recommended Power Cable (60 m max.)/ 推荐电源电缆 (最大 60 m)

XS5F-D42□□80-F (made by OMRON/欧姆龙制造)

6. Regulations and Standards/法规和标准

1. China/中华人民共和国

CMIIT ID	Model
2019DJ5570	V780-HMD68-ETN-CN-S

- 使用频率: 920-925MHz
载波频率容限: 20×10^{-4}
发射功率小于 2W (e. r. p)
占用带宽不大于 250kHz
信道中心频率:
 f_c (MHz) = 920.125 + M × 0.25 (N, M 为整数, 取值为 0-19)
邻道功率泄漏比: 40dB (第一邻道), 60dB (第二邻道)
工作模式为跳频扩频方式, 每跳频信道最大驻留时间 2 秒
杂散发射限值 (在两频段之间的载波频率 ± 1MHz 范围以外): 请参考 2007/205 号文件
- 不得擅自更改发射频率、加大发射功率 (包括额外加装射频功率放大器), 不得擅自外接天线或改用其它发射天线;
- 使用时不得对各种合法的无线电通信业务产生有害干扰; 一旦发现有干扰现象时, 应立即停止使用, 并采取消除措施后方可继续使用;
- 使用微功率无线电设备, 必须忍受各种无线电业务的干扰或工业、科学及医疗应用设备的辐射干扰;
- 不得在飞机和机场附近使用。

2. UL Certification/UL 认证

V780-HMD68-ETN has been certified by UL/V780-HMD68-ETN 已通过 UL 认证

• There is a danger of burns when using at high temperature.
高温下使用时有灼伤危险。

• The V780-HMD68-ETN is used for factory use. Do not use in medical applications.
V780-HMD68-ETN 用途为工厂使用。请勿用于医疗应用。

• Use UL certification cable.
使用 UL 认证电缆。

• The symbol "≡" on the product label indicates direct current.
产品标签上的符号 "≡" 表示直流电流。

• If the equipment is used in a manner not specified by the manufacturer, the protection provided by the equipment may be impaired.
如果以制造商未指定的方式使用设备, 则设备提供的保护可能会受到损害。

• Installation direction
安装方向

[Ceil Mounting/天花板安装]

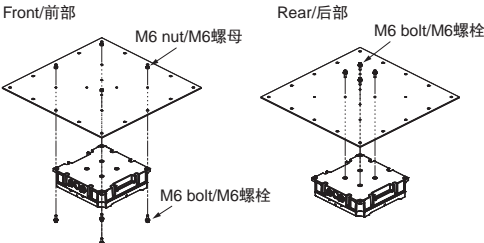

[Side Mounting/侧面安装]

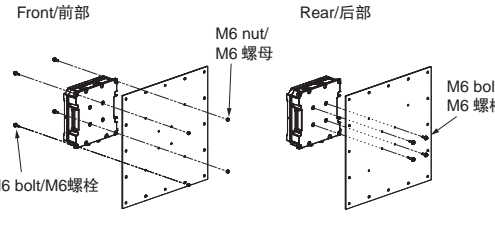

• A statement of range of environmental conditions.
环境条件范围的声明。

Pollution degree 污染等级	3
Used place 使用场所	Indoor use 室内使用
Altitude 海拔	up to 2000 m 最高 2000m

Suitability for Use

Omron Companies shall not be responsible for conformity with any standards, codes or regulations which apply to the combination of the Product in the Buyer's application or use of the Product. At Buyer's request, Omron will provide applicable third party certification documents identifying ratings and limitations of use which apply to the Product. This information by itself is not sufficient for a complete determination of the suitability of the Product in combination with the end product, machine, system, or other application or use. Buyer shall be solely responsible for determining appropriateness of the particular Product with respect to Buyer's application, product or system. Buyer shall take application responsibility in all cases. NEVER USE THE PRODUCT FOR AN APPLICATION INVOLVING SERIOUS RISK TO LIFE OR PROPERTY WITHOUT ENSURING THAT THE SYSTEM AS A WHOLE HAS BEEN DESIGNED TO ADDRESS THE RISKS, AND THAT THE OMRON PRODUCT(S) IS PROPERLY RATED AND INSTALLED FOR THE INTENDED USE WITHIN THE OVERALL EQUIPMENT OR SYSTEM. See also Product catalog for Warranty and Limitation of Liability.

使用时的注意事项

在客户的应用中, 欧姆龙不负责产品与任何客户端产品所涉及的规格、规范和标准保持一致性。请务必考虑本产品对于所应用的系统、机器和设备间的适用性。使用时请注意遵守本产品的禁止事项。

在没有确认整个系统设计时所考虑到的风险, 以及没有确认在设备和系统中该欧姆龙产品的额定使用条件和正确安装条件的情况下, 禁止将本产品应用于对人身及财产存在严重危险的情况。详见产品规格书中保证及免责声明内容。

OMRON Corporation Industrial Automation Company

Kyoto, JAPAN Contact: www.ia.omron.com

- Regional Headquarters**
- OMRON EUROPE B.V.**
Sensor Business Unit
Carl-Benz-Str. 4, D-71154 Nufringen, Germany
Tel: (49) 7032-811-0/Fax: (49) 7032-811-199
- OMRON ELECTRONICS LLC**
2895 Greenspoint Parkway, Suite 200
Hoffman Estates, IL 60169 U.S.A.
Tel: (1) 847-843-7900/Fax: (1) 847-843-7787
- OMRON ASIA PACIFIC PTE. LTD.**
No. 438A, Alexandra Road # 05-05/08 (Lobby 2),
Alexandra Technopark,
Singapore 119967
Tel: (65) 6835-3011/Fax: (65) 6835-2711
- OMRON (CHINA) CO., LTD.**
Room 2211, Bank of China Tower,
200 Yin Cheng Zhong Road,
PuDong New Area, Shanghai, 200120, China
Tel: (86) 21-5037-2222/Fax: (86) 21-5037-2200

联系方式

- 制造商
欧姆龙 (上海) 有限公司
地址: 中国 (上海) 自由贸易试验区金吉路 789 号
电话: (86)21-50509988
- 技术咨询
欧姆龙自动化 (中国) 有限公司
地址: 中国上海市浦东新区银城中路 200 号中银大厦 2211 室
电话: (86)21-5307-2222

技术咨询热线
400-820-4535
网址: http://www.ia.omron.com.cn