

OMRON

Smart Power Supply

S8AS

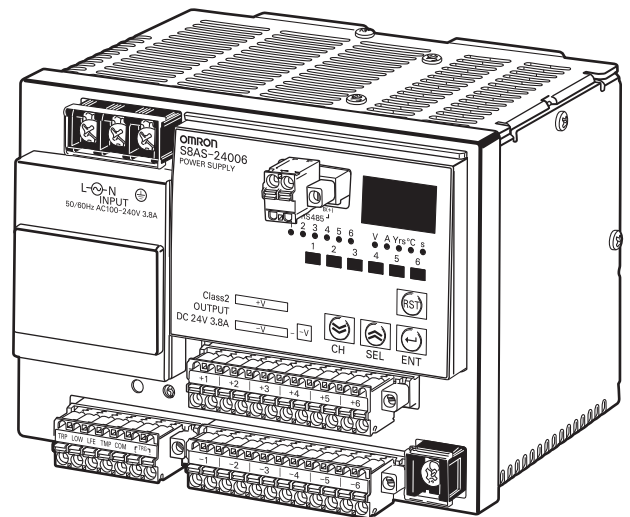

USER'S MANUAL

Cat. No. Z269-E1-07

S8AS Smart Power Supply

User's Manual

Revised September 2022

About this Manual:

This manual describes the installation and operation of the S8AS Smart Power Supply and includes the sections described below.

Please read this manual carefully and be sure you understand the information provided before attempting to install or operate the S8AS Smart Power Supply. Be sure to read the precautions provided in the following section.

Precautions provides general precautions for using the S8AS Smart Power Supply and related devices.

Section 1 introduces the features and functions of the S8AS Smart Power Supply and concepts related to its operation.

Section 2 identifies the S8AS Smart Power Supply's components, provides specifications, and describes the basic functions.

Section 3 describes how to install and wire the S8AS Smart Power Supply.

Section 4 describes how to set the S8AS's various parameters.

Section 5 describes how to connect the branch outputs and test operation.

Section 6 describes how to use S8AS communications.

Section 7 provides information on troubleshooting problems that may occur with the S8AS Smart Power Supply.

The appendices provide a glossary of terms related to the S8AS and flowcharts of S8AS key operations.



WARNING Failure to read and understand the information provided in this manual may result in personal injury or death, damage to the Product, or Product failure. Please read each section in its entirety and be sure you understand the information provided in the section and related sections before attempting any of the procedures or operations given.

TABLE OF CONTENTS

SECTION 1

Features and Functions 1

1-1	Overview of Features and Functions	2
1-2	S8AS Operating Modes	7
1-3	Table of Basic Functions	10
1-4	S8AS Operating Procedure	13

SECTION 2

Specifications and Functions 15

2-1	Component Names and Functions	16
2-2	Internal Configuration	20
2-3	Specifications	22
2-4	Basic Function Details	29
2-5	Startup Sequence Function	37
2-6	Shutdown Sequence Function	38
2-7	External Tripping Input Function	39

SECTION 3

Installation and Wiring 41

3-1	Installing the S8AS	42
3-2	Installation	44
3-3	Power Supply and Input/Output Wiring	47
3-4	RS-485 Port Wiring	52

SECTION 4

Parameter Settings 53

4-1	Parameter Table	54
4-2	Switching the Operating Mode	56
4-3	Changing the Protection Level	59
4-4	Switching to Setting Mode	60
4-5	Individual Branch Output Settings	61
4-6	Shared Parameter Settings	63
4-7	Special Settings and Communications Settings	66

SECTION 5

Trial Operation to Actual Operation 77

5-1	Test Mode	78
5-2	Connection/Disconnection Test	80
5-3	Checking Sequence Operation	81
5-4	Run Mode	82

TABLE OF CONTENTS

SECTION 6

Communications	87
6-1 CompoWay/F Communications Specifications	88
6-2 Frame Structure	90
6-3 Variable Area Operations	99
6-4 Read Controller Information	102
6-5 Read Controller Attributes	103
6-6 Read Controller Status	104
6-7 Echoback Test	106
6-8 Operation Command	107
6-9 Response Code List	109
6-10 ASCII List	110

SECTION 7

Error Processing	111
7-1 Troubleshooting	112
7-2 Seven-segment Error Codes	114
7-3 Clearing Errors	115

Appendices

A Glossary	117
B List of Operations	121

Revision History	125
-------------------------------	------------

Terms and Conditions Agreement

Warranty, Limitations of Liability

Warranties

● Exclusive Warranty

Omron's exclusive warranty is that the Products will be free from defects in materials and workmanship for a period of twelve months from the date of sale by Omron (or such other period expressed in writing by Omron). Omron disclaims all other warranties, express or implied.

● Limitations

OMRON MAKES NO WARRANTY OR REPRESENTATION, EXPRESS OR IMPLIED, ABOUT NON-INFRINGEMENT, MERCHANTABILITY OR FITNESS FOR A PARTICULAR PURPOSE OF THE PRODUCTS. BUYER ACKNOWLEDGES THAT IT ALONE HAS DETERMINED THAT THE PRODUCTS WILL SUITABLY MEET THE REQUIREMENTS OF THEIR INTENDED USE.

Omron further disclaims all warranties and responsibility of any type for claims or expenses based on infringement by the Products or otherwise of any intellectual property right.

● Buyer Remedy

Omron's sole obligation hereunder shall be, at Omron's election, to (i) replace (in the form originally shipped with Buyer responsible for labor charges for removal or replacement thereof) the non-complying Product, (ii) repair the non-complying Product, or (iii) repay or credit Buyer an amount equal to the purchase price of the non-complying Product; provided that in no event shall Omron be responsible for warranty, repair, indemnity or any other claims or expenses regarding the Products unless Omron's analysis confirms that the Products were properly handled, stored, installed and maintained and not subject to contamination, abuse, misuse or inappropriate modification. Return of any Products by Buyer must be approved in writing by Omron before shipment. Omron Companies shall not be liable for the suitability or unsuitability or the results from the use of Products in combination with any electrical or electronic components, circuits, system assemblies or any other materials or substances or environments. Any advice, recommendations or information given orally or in writing, are not to be construed as an amendment or addition to the above warranty.

See <http://www.omron.com/global/> or contact your Omron representative for published information.

Limitation on Liability; Etc

OMRON COMPANIES SHALL NOT BE LIABLE FOR SPECIAL, INDIRECT, INCIDENTAL, OR CONSEQUENTIAL DAMAGES, LOSS OF PROFITS OR PRODUCTION OR COMMERCIAL LOSS IN ANY WAY CONNECTED WITH THE PRODUCTS, WHETHER SUCH CLAIM IS BASED IN CONTRACT, WARRANTY, NEGLIGENCE OR STRICT LIABILITY.

Further, in no event shall liability of Omron Companies exceed the individual price of the Product on which liability is asserted.

Application Considerations

Suitability of Use

Omron Companies shall not be responsible for conformity with any standards, codes or regulations which apply to the combination of the Product in the Buyer's application or use of the Product. At Buyer's request, Omron will provide applicable third party certification documents identifying ratings and limitations of use which apply to the Product. This information by itself is not sufficient for a complete determination of the suitability of the Product in combination with the end product, machine, system, or other application or use. Buyer shall be solely responsible for determining appropriateness of the particular Product with respect to Buyer's application, product or system. Buyer shall take application responsibility in all cases.

NEVER USE THE PRODUCT FOR AN APPLICATION INVOLVING SERIOUS RISK TO LIFE OR PROPERTY WITHOUT ENSURING THAT THE SYSTEM AS A WHOLE HAS BEEN DESIGNED TO ADDRESS THE RISKS, AND THAT THE OMRON PRODUCT(S) IS PROPERLY RATED AND INSTALLED FOR THE INTENDED USE WITHIN THE OVERALL EQUIPMENT OR SYSTEM.

Programmable Products

Omron Companies shall not be responsible for the user's programming of a programmable Product, or any consequence thereof.

Disclaimers

Performance Data

Data presented in Omron Company websites, catalogs and other materials is provided as a guide for the user in determining suitability and does not constitute a warranty. It may represent the result of Omron's test conditions, and the user must correlate it to actual application requirements. Actual performance is subject to the Omron's Warranty and Limitations of Liability.

Change in Specifications

Product specifications and accessories may be changed at any time based on improvements and other reasons. It is our practice to change part numbers when published ratings or features are changed, or when significant construction changes are made. However, some specifications of the Product may be changed without any notice. When in doubt, special part numbers may be assigned to fix or establish key specifications for your application. Please consult with your Omron's representative at any time to confirm actual specifications of purchased Product.

Errors and Omissions

Information presented by Omron Companies has been checked and is believed to be accurate; however, no responsibility is assumed for clerical, typographical or proofreading errors or omissions.

Safety Precautions

■ Precaution Classifications

The following conventions are used to indicate and classify precautions in this manual.

Always heed the information provided with them. Failure to heed precautions can result in injury to people or damage to property.



Indicates a potentially hazardous situation which, if not avoided, may result in minor or moderate injury or in property damage.

■ Cautions

CAUTION	
Minor electric shock, fire, or Product failure may occasionally occur. Do not disassemble, modify, or repair the Product or touch interior of the Product.	
Minor burns may occasionally occur. Do not touch the Product during power is being supplied or immediately after power is turned OFF.	
Minor injury may occasionally occur due to electrical shock. Do not touch the terminals while power is being supplied. Also, be sure to close the terminal cover after wiring the terminals.	
Fire may occasionally occur. Tighten terminal screws to the specified torque.	
Minor electric shock, fire, or Product failure may occasionally occur. Do not allow any pieces of metal or conductors or any clippings or cuttings resulting from installation work to enter the Product.	
A maximum voltage of 370 V may be generated internally when power is supplied. This voltage will remain for 30 s even after the power supply has been turned OFF.	

Take adequate security measures against DDoS attacks (Distributed Denial of Service attacks), computer viruses and other technologically harmful programs, unauthorized access and other possible attacks before using this product.

■ Security Measures

<p>Anti-virus protection Install the latest commercial-quality antivirus software on the computer connected to the control/monitor system and maintain to keep the software up-to-date.</p>	
<p>Security measures to prevent unauthorized access Take the following measures to prevent unauthorized access to our products.</p> <ul style="list-style-type: none"> • Install physical controls so that only authorized personnel can access control/monitor systems and equipment. • Reduce connections to control/monitor systems and equipment via networks to prevent access from untrusted devices. • Install firewalls to shut down unused communications ports and limit communications hosts and isolate control/monitor systems and equipment from the IT network. • Use a virtual private network (VPN) for remote access to control/monitor systems and equipment. • Scan virus to ensure safety of SD cards or other external storages before connecting them to control/monitor systems and equipment. 	
<p>Data input and output protection Validate backups and ranges to cope with unintentional modification of input/output data to control/monitor systems and equipment.</p> <ul style="list-style-type: none"> • Checking the scope of data • Checking validity of backups and preparing data for restore in case of falsification and abnormalities • Safety design, such as emergency shutdown, in case of data tampering and abnormalities 	
<p>Data recovery Backup data and keep the data up-to-date periodically to prepare for data loss.</p>	

Precautions for Safe Use

The S8AS Smart Power Supply combines the highly reliable S8VS Switch Mode Power Supply with the S8M Digital Multicircuit Protector into a single unit to reduce both wiring and space requirements. The built-in digital circuit protector uses semiconductor relays to close and trip circuits, and does not contain any contact switching mechanisms, as normal circuit protectors do.

Observe the following precautions when introducing the S8AS into or using the S8AS in any system.

■ Installation and Storage Environment

1. Store the Product at an ambient temperature of -25 to 65°C and relative humidity of 25% to 90%.
2. To maintain performance of the maintenance forecast monitor, make sure the following conditions are satisfied for long-term storage.
 - For storage exceeding three months, keep the Product at a temperature of -20°C to 30°C and a humidity of 25% to 70%.
3. Internal parts may occasionally be deteriorated or damaged. Do not use the Product in conditions exceeding the derating curve (in portion (1) of the derating curve on page xiv).
4. Internal parts may possibly be damaged. Do not use a current that exceeds the rated total output current. If temporary peak currents occur repetitively, design the system so that the peak currents do not exceed the rated total output current.
5. The surrounding air temperature to comply with UL508 and UL60950-1 is 25°C .
6. Use the Product where the relative humidity is 25% to 85%.
7. Do not use the Product where it would be subjected to direct sunlight.
8. Do not use the Product where it would be subjected to the possibility of penetration of liquid, foreign substance, or corrosive gas.
9. Do not use the Product where it would be subjected to shock or vibration. A device such as a contact breaker may be a vibration source. Set the Product as far as possible from possible sources of shock or vibration. Additionally, install a PFP-M End Plate on each end of the Product after mounting it to a DIN Rail.
10. Use a DIN Rail made of steel. If an aluminum DIN Rail is used, vibration or shock may cause the formation of metal dust due to abrasion of the aluminum.
11. Poor heat dissipation may deteriorate or damage internal parts. Do not loosen the screws on the side of the Product.
12. If the Product is used in an area with excessive electronic noise, be sure to separate the Product as far as possible from the noise sources.
13. Cutoff performance is guaranteed according to the ambient operating temperature. Use the Product within the derating range. Refer to the *Derating Curve* on page xiv.
14. Poor heat dissipation resulting from improper installation conditions may occasionally deteriorate or damage internal parts and also cause the maintenance forecast monitor function to not operate properly. Do not use any mounting orientation other than a standard one.

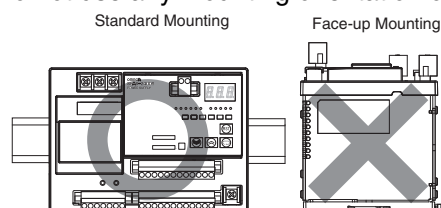

15. Do not connect a battery or other backup power supply to the output of the Product.
16. To comply with UL standards, insert a fast-breaking, UL-approved fuse rated at 20 A into each input line.
17. Although some inverters have an output frequency of 50/60 Hz, they may cause internal temperatures to rise, possibly resulting in burning, if they are connected as the power source for the S8AS. Do not use the output from an inverter as the power source for the S8AS.

■ Installation and Wiring

1. Minor electric shock during operation may occasionally occur. Always attach the cover or take other precautions so that the terminals cannot be touched directly.
Also, connect the ground completely. The ground is a protective earth (PE) terminal specified in safety standards. If the ground is not connected completely, electric shock or malfunction may occur.
2. Minor fire may possibly occur. Ensure that input and output terminals are wired correctly.
3. Heat generated by wiring materials may cause the temperature of internal parts to increase, which may result in deterioration of or damage to the internal parts. Select the wiring materials according to the current that is being used.
4. Using the wiring materials, torque, and wire stripping length specified in *3-3 Power Supply and Input/Output Wiring* is recommended to prevent smoke or fire of the wire material due to an abnormal load.
5. It is conceivable that internal parts may be deteriorated or damaged. Do not repeatedly perform cutoff or recovery operations more than necessary.
6. Do not push more than 100 N of force to the terminal block when tightening screws.
7. Be sure to tighten the lock screws on the sides of the connector after connecting any output connector. When removing a connector, be sure the lock screws are completely loose before pulling on the connector.
8. Be sure to remove the sheet covering the Product during installation before turning ON the power.

■ Output Voltage Adjustment

1. The output voltage adjuster (V.ADJ.) may possibly become damaged. Do not apply more than the required force.
2. Do not exceed the rated output capacity and rated total output current after adjusting the output voltage.

■ Periodic Inspections

Under normal operating conditions, the Product will require several years or even more than ten years until the maintenance forecast monitor function operates. When using the Product for an extended period of time, perform the following procedure periodically to confirm that the output for the maintenance forecast monitor function (LFE) is operating correctly.

- a) Change to Run Mode.
- b) Confirm that the (LFE) output is ON (electrical continuity between LFE and COM).

Note For details about terminal names, refer to *2-1 Component Names and Functions*.

Precautions for Correct Use

- When the tripping alarm output operates, always remove the cause of the output first and then reset the alarm.
- When cycling the input power supply, always remove any problems first and then turn ON the input power supply.

■ Startup Time

When the input power is turned ON to the S8AS, a hardware check, software check, and initialization processing are performed before the branch outputs are turned ON. Approximately three seconds is required. When using the S8AS with other control equipment, incorporate the startup time of the S8AS in the overall system design.

■ Installation

• Mounting Direction

Mount the S8AS to a DIN Rail using the standard mounting direction. Do not mount it in any other direction, such as face up.

(Refer to 3-1 *Installing the S8AS*.)

• Mounting Space

The long-term reliability of the S8AS can be increased by installing it properly and sufficiently considering heat dissipation.

Be sure to install the S8AS so that the air flow circulates around it, because the S8AS is designed to radiate heat by means of natural air circulation.

■ Derating Curve

The temperature range within which the S8AS can be used is restricted by the maximum current that normally flows for the total output. This restriction is given as a derating curve.

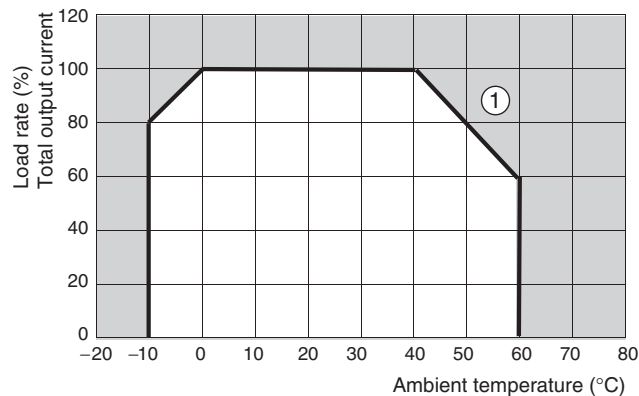

Note

1. The ambient temperature is measured at a point 50 mm below the S8AS.
2. Use forced cooling if necessary to satisfy the derating curve.
3. For 480-W models, reduce the load to 80% or less for long-term use at an input voltage of 95 VAC or less.

■ Abnormal Voltage Tripping

1. The S8AS has an abnormal voltage tripping function. All branch outputs will be cut off if the input voltage exceeds 28.8 VDC. This function, however, does not protect loads and internal parts from high voltages in all cases. Be sure the output voltage is within the rated range.
2. Outputs may be cut off by the abnormal voltage protection with loads that generate reverse peak electro-motive force.

■ Abnormal Current Tripping

The S8AS has an abnormal current tripping function. A branch output will be cut off if its current exceeds a pre-set value. Also, all branch outputs will be cut off if their total peak output current exceeds a specified value.

Note

1. Continuing operation with overcurrent may occasionally result in deterioration or destruction of internal elements.
2. Do not use the S8AS for applications in which load inrush current or overload will frequently occur. Doing so may result in deterioration or damage to internal components.

■ Maintenance Forecast Monitor Function

The accuracy of the maintenance forecast monitor function will be reduced in applications where the AC input turns ON and OFF frequently.

■ Tripping Performance

There are three methods that can be used to determine abnormal current trippings: Standard Detection, Instantaneous Detection, and Extended Detection. (This is not possible for the S8AS-24006N/48008N.) Refer to *2-4-2 Over-current Protection Functions* for details of cutoff performance.

Note

1. When the tripping alarm output operates, always remove the cause of the output first and then reset the alarm.
2. When using a load with a fixed-power operation, the S8AS may cause a cutoff when the power supply is turned OFF.
3. Tolerance of current tripping alarm threshold is ± 0.3 A.
4. Use Extended Detection only when using OMRON Remote I/O Terminal with short-circuit detection.

■ Total Peak Output Current

The S8AS is designed to provide a temporary peak current to provide the overcurrent required to start load devices.

The total peak output current for all branch outputs combined is given below.

If the total current exceeds any of these values, all branch outputs will be cut off according to the size of the peak current or application time to ensure safety.

• 240-W Models

Input voltage range:	200 to 240 VAC
Peak current/Peak current pulse width:	17 A max. for 2 s max. 15 A max. for 5 s max. 13 A max. for 10 s max. 12 A max. for 20 s max.

If the total output peak current exceeds even one of these conditions, all branch outputs will be shut off to ensure safety.

• 480-W Models

Input voltage range:	200 to 240 VAC
Peak current/Peak current pulse width:	27 A max. for 1 s max. 25 A max. for 2 s max. 22.5 A max. for 5 s max.

Note

1. If the input voltage range is not within the values specified above or the total output current exceeds the maximum peak current value, internal operation will become unstable and the branch outputs may be cut off.
2. Maintain the total current for normal operation after the load devices have started to within the rated ranges.

3. Do not allow a peak current to flow again for at least 60 seconds after a peak current has exceeded the rated current.

■ Startup Delay

The S8AS has a startup delay function that prevents cutoffs caused by inrush current at startup.

The startup delay disables the cutoff operation for 40 ms after the semiconductor relay turns ON.

To protect internal circuits, however, the relevant branch outputs will be cut off even during the startup delay period if a current limit is exceeded within a specific time period.

Note The startup delay will not operate when a relay or other device is used for ON/OFF control on the output side of the S8AS, so a cutoff operation may occasionally occur.

■ Dielectric Strength Test

The S8AS is designed to withstand 3,000 VAC for 1 minute between the AC input terminals collectively and the branch output, I/O signal, or communications terminals collectively. When testing, set the cutoff current for the withstand voltage test device to 20 mA.

Note

1. The S8AS may possibly be damaged from the impulse voltage if a testing device switch is used to abruptly apply or cut off 3000 VAC. Increase the applied voltage gradually using the voltage adjustment on the testing device.
2. When testing terminals together, always short the specified terminals so that the voltage is applied to all of the terminals at the same time.

■ Insulation Resistance Test

When testing the insulation resistance, use a DC resistance meter at 500 VDC.

Note To prevent damage, always short branch output terminals (+/-), all I/O terminals, and communications terminals before testing.

■ Output Voltage Adjustment

Default setting: Set as the rated voltage.

Adjustable range: Adjustable from -10% to +10% of the rated output voltage by using the V.ADJ. adjuster on the front or the Power Supply. Turning the adjuster clockwise increases the output voltage, and turning it counterclockwise decreases the output voltage.

Note

1. If the output voltage is set to less than 20 V (default setting), the undervoltage detection may be activated.
2. Do not exceed the rated output capacity and rated total output current after adjusting the output voltage.
3. The output voltage may increase beyond the allowable voltage range rated voltage +10% when the V.ADJ adjuster is used. When adjusting the output voltage, check the output voltage of the power supply to make sure that the load is not damaged.

■ No Output Voltage

The internal circuit's overcurrent protection or overvoltage protection may operate. Alternatively, the latch protection circuit may operate if there is a lightning surge or other large voltage applied to the input.

Contact your OMRON representative if there is still no output voltage after checking the following two points:

- Checking Overcurrent Protection
Check whether the load is in an overcurrent or short-circuited state. Remove the wires to the load before checking.
- Checking Overvoltage Protection and Latching Protection
Turn the power supply OFF and leave it OFF for at least 3 minutes, then turn it ON again.

■ Startup Time

At startup, the S8AS will check hardware and software before starting the operation of branch outputs. A time of approximately 3 seconds is required for these self-diagnostic functions. Take this time into account when designing the system.

■ External Tripping Input

Wire the polarity of the external tripping input correctly. After completing wiring, confirm that operation is correct.

■ Tripping Alarm Output, Undervoltage Detection Output, Maintenance Forecast Monitor Output, and Over-temperature Output

Photoswitch outputs: 30 VDC max., 50 mA max., residual voltage when ON: 2 V max., leakage current when OFF: 0.1 mA max.

Wire all output signal circuits correctly. Internal current control circuits are not provided internally for output signals. Do not allow the output current to exceed 50 mA. After completing wiring, confirm that the circuits operate correctly.

■ Displaying the Output Voltage

The voltage detection function displays on the 7-segment display the voltage that is monitored at the internal circuit after AC/DC conversion. The displayed voltage will be somewhat lower than the value at the output terminals of the power source due to internal voltage drop. To accurately confirm the output voltage, measure it at the branch output terminal.

■ Prohibition of Parallel Connection

Do not connect branch outputs from the S8AS in parallel. Also, do not connect the branch outputs in parallel with branch outputs of other S8AS Power Supplies.

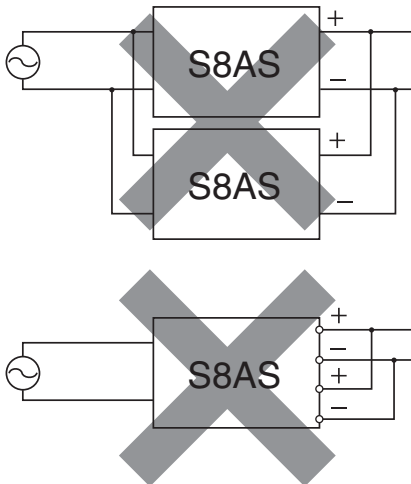

Connections cannot be made in parallel with other branch output circuits.

■ Supplementary Information: Conformity to IEC and EN Safety Standards

Warning: The S8AS is a Class A product. In a residential, commercial, or light industrial environment, it may cause radio interference. The S8AS is not intended to be installed in a residential environment. In a commercial or light industrial environment with connection to a commercial power supply, the user may be required to take adequate measures to reduce interference.

Using this Manual

■ Notation in this Manual

In this manual, the S8AS Smart Power Supply is referred to as the S8AS.

■ Notation of Setting Data

Setting data codes and contents are displayed in seven-segment display characters, as shown in the following diagram.

<i>A</i>	<i>b</i>	<i>c</i>	<i>d</i>	<i>E</i>	<i>F</i>	<i>G</i>	<i>H</i>	<i>i</i>	<i>j</i>	<i>K</i>	<i>L</i>	<i>m</i>
A	B	C	D	E	F	G	H	I	J	K	L	M

<i>n</i>	<i>o</i>	<i>P</i>	<i>q</i>	<i>r</i>	<i>S</i>	<i>t</i>	<i>U</i>	<i>v</i>	<i>y</i>	<i>z</i>	<i>z</i>	<i>z</i>
N	O	P	Q	R	S	T	U	V	W	X	Y	Z

SECTION 1

Features and Functions

This section describes the features and functions of the S8AS.

1-1	Overview of Features and Functions	2
1-2	S8AS Operating Modes	7
1-3	Table of Basic Functions.....	10
1-4	S8AS Operating Procedure	13

1-1 Overview of Features and Functions

The S8AS Smart Power Supply is a 24-VDC power supply unit with an internal digital circuit protector that incorporates the highly reliable S8VS Switch Mode Power Supply and the S8M Digital Multicircuit Protector in one unit.

The input power supply to the S8AS is 100 to 240 VAC at 50/60 Hz. Models are available for 240 W with 6 branch outputs or for 480 W with 8 branch outputs, with and without communications. Models for which parameters cannot be changed are also available.

The S8AS provides a stable 24-VDC power supply at an output current of 3.8 A maximum.

Model Number Legend

S8AS Model Numbers

S8AS-
1 2 3

No.	Item	Code	Meaning
1	Output capacity	240	240 W
		480	480 W
2	Number of output branches	06	6 branch outputs
		08	8 branch outputs
3	Communications / Additional functions	blank	Changeable parameter settings with no communications
		N	Unchangeable parameter settings with no communications
		R	Changeable parameter settings with communications (RS-485)

Reduced Space, Wiring, and Work

■ Combination of S8VS and S8M

The space required within the control panel and the amount of wiring have been reduced by integrating a Digital Multicircuit Protector into a Switch Mode Power Supply.

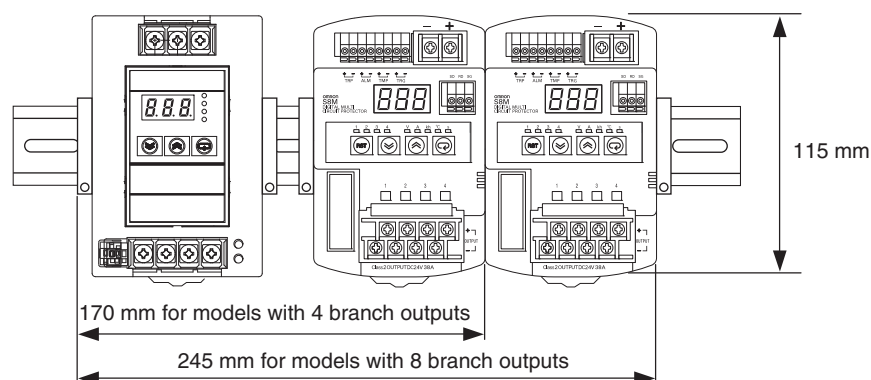

■ S8AS-24006□ (240 W, 6 Branch Outputs)

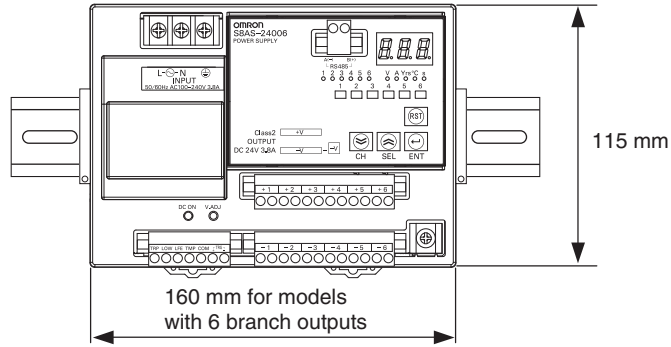

■ S8AS-48008□ (480 W, 8 Branch Outputs)

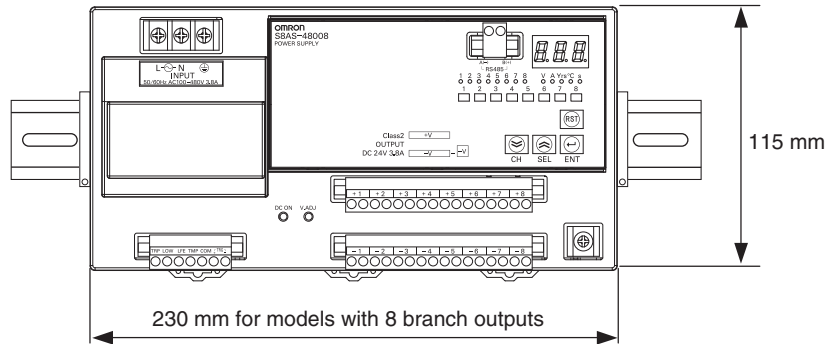

Power Supply and Branch Outputs

The power supply section incorporates the highly praised AC-DC conversion circuit of the S8VS Switch Mode Power Supply in order to produce stable 24-VDC power.

The branch output circuits consist of the protection circuits and tripping circuits of the S8M Digital Circuit Protector. They support various safety functions, such as overvoltage protection, overcurrent protection, and short-circuit protection, as well as maintenance functions, such as monitoring using the seven-segment display, error indications, and various alarm outputs.

Models that support communications can be monitored from a host computer using RS-485 communications.

Branch Output Tripping Circuits

No-contact Switching

The S8AS built-in circuit protectors differ from conventional mechanical contact-type circuit protectors in that they use no-contact transistor relay switching. Without the contact life of mechanical circuit protectors, semiconductor relays are able to provide a much longer lifetime. Digital processing also provides other benefits, such as being able to specify detailed overcurrent detection conditions.

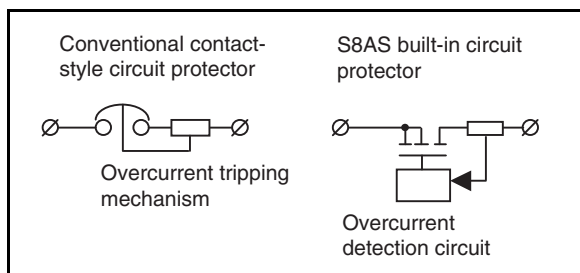

Tripping Current Can be Set for Each Branch Output

The abnormal tripping current value can be set for each branch output.
Setting range: 0.5 to 3.8 A (in 0.1 A increments).
Tolerance of current tripping threshold: ± 0.3 A.

Abnormal Current Detection and Tripping Time

The abnormal current tripping characteristics can be set for each branch output. (This is not possible for the S8AS-24006N/48008N.)
There are three methods that can be used to determine abnormal current trippings. (This is not possible for the S8AS-24006N/48008N.)

■ Standard Detection

When the current exceeds the set value, the branch output is cut off within 100 ms.

■ Instantaneous Detection

When the current exceeds the set value, the branch output is cut off within 20 ms.

■ Extended Detection

When the current exceeds the set value, the branch output is cut off within 1,000 ms.

Error Indication and Alarm Output for Abnormal Current Tripping

The following will occur when an abnormal current is detected and the branch output is cut off:

- The branch output status indicator will light red.
- The seven-segment display will show the error code A11 and the abnormal current value alternately.
- The external output terminal for tripping alarms (TRP) will turn ON. (The photoswitch output will turn OFF.)

Always remove the cause of the abnormal current before resetting the alarm.

Tripping for Total Peak Output Current

When the total branch output current exceeds the set value for a specified amount of time, all branch outputs will be cut off.

- All branch output status indicators will light red.
- The seven-segment display will flash the error code A12.
- The external output terminal for tripping alarms (TRP) will turn ON. (The photoswitch output will turn OFF.)

Abnormal Voltage Tripping

If the output voltage exceeds 28.8 VDC, all branch outputs will be cut off in order to protect load devices.

The following will happen when this occurs:

- The seven-segment display will show the error code A10 and the abnormal voltage alternately.
- The external output terminal for tripping alarms (TRP) will turn ON. (The photoswitch output will turn OFF.)

Internal Temperature Monitor

The S8AS has an built-in temperature sensor that constantly measures the internal temperature. The temperature can be read from the seven-segment display. The temperature display range is -20 to 100°C . The temperature sensor has one external output (TMP), which can be used to control cooling equipment for the control panel.

The temperature output setting range is 25 to 90°C .

- The seven-segment display will show the error code A30 and temperature ($^{\circ}\text{C}$) alternately.

- The external output terminal for over-temperature (TMP) will turn ON. (The photoswitch output will turn OFF.)

Maintenance Forecast Monitor Function

This function calculates the condition of the electrolytic capacitor based on the power-ON time and internal temperature of the Power Supply to forecast when the Power Supply needs to be replaced. The monitor value can be set to between 0.0 and 5.0 years (approximate) in increments of 0.5 years.

The following occurs when the estimated replacement time reaches the set value:

- The seven-segment display will show the error code A23 and the replacement time (years) alternately.
- The external output terminal for the maintenance forecast monitor (LFE) will turn ON. (The photoswitch output will turn OFF.)

Safety Functions

If an abnormal voltage or current is detected, the semiconductor relay will cut off the branch output. In the unlikely event that the semiconductor relay cannot cut off an abnormal current or short-circuit current, the short-circuit protection fuse will cut the circuit to protect the system. If the branch output is cut off by the fuse, an error indication will not be shown on the seven-segment display and the alarm output (TRP) will not operate.

The overcurrent protection fuse or over-temperature fuse cannot be replaced. If a fuse burns out, use a different branch output or replace the S8AS.

External Outputs

The S8AS has 4 external outputs: the Tripping Alarm Output (TRP), Undervoltage Detection Output (LOW), Maintenance Forecast Monitor Output (LFE), and Over-temperature Output (TMP).

Output	Output condition	Restoration condition
Tripping Alarm Output (TRP)	<ul style="list-style-type: none"> • Abnormal voltage tripping If the output voltage exceeds 28.8 V, all branch outputs are cut off. • Abnormal current tripping If a current exceeding the set value is detected, the corresponding branch output is cut off. 	The output status is retained when power is interrupted but can reset with the reset operation.
	Test Mode only When even one branch output is disconnected.	Restore by connecting all branch outputs, or by switching to any mode other than Test Mode.
Undervoltage Detection Output (LOW)	Output when the 24 VDC output falls below the undervoltage detection threshold.	This output can be reset with the reset operation. If the alarm is cleared when the power is turned ON, the output will be reset.
Over-temperature Output (TMP)	Output when a temperature exceeding the threshold is detected.	The output is reset automatically when the temperature falls to 3°C below the over-temperature output threshold.
Maintenance Forecast Monitor Output (LFE)	<ul style="list-style-type: none"> • Output when the estimated replacement time falls below the set value. • Output when the replacement time can no longer be calculated due to rise in temperature of the power supply section. 	<ul style="list-style-type: none"> • Prepare to replace the Power Supply. • Take measures to lower the internal temperature.

Tripping Functions Using External Signals

Branch outputs can be forcibly cut off by turning ON the External Tripping Input (TRG).

- Tripping using the External Tripping Input can be enabled or disabled independently for each branch output. Refer to *Tripping Input Trigger Setting: TRG (Trigger)* on page 68.
- The External Tripping Input directly cuts off a branch output's DC circuit, so it acts even faster than cutting off the output by turning OFF the normal AC power supply.
- When a shutdown sequence has been set, this function can be used to set a time lag for the branch output cutoff. (For details, refer to *2-6 Shutdown Sequence Function*.)
- The tripping input type can be set. (Refer to *2-7 External Tripping Input Function*)
 - EGE: Output cut off when the tripping input changes from OFF to ON.
 - LVL: Output cut off when the tripping input changes from OFF to ON and connected when tripping input changes from ON to OFF.

Additional Functions

Startup Sequence Function

A delay can be set for the connection of the branch outputs. When you want to apply a startup delay to the branch output, it is not necessary to construct an external sequence circuit. The inrush current can be suppressed by applying a delay and the Power Supply Unit's load can be reduced. (For details, refer to *2-5 Startup Sequence Function*.)

Shutdown Sequence Function

The branch outputs' cutoff can be delayed. When you want to apply a shutdown delay to the branch output, it is not necessary to construct an external sequence circuit. (For details, refer to *2-6 Shutdown Sequence Function*.)

Protecting Parameter Settings (Protection Level Settings)

The Protection Level can be set to restrict access to the parameters. Three levels, levels 0, 1, and 2, are available. This function can be used to prevent parameters from being changed or deleted inadvertently.

Protection level	Restrictions
0	There are no restrictions on reading and changing the parameter settings.
1	Permits only reading and changing of the output voltage, current, internal temperature, and maintenance forecast monitor parameters.
2	Permits only reading of the output voltage, current, internal temperature, and maintenance forecast monitor parameters.

The default setting is protection level 1. (For details, refer to *4-3 Changing the Protection Level*.)

Note The read/write access for models that do not support parameter changes (S8AS-24006N/48008N) cannot be changed regardless of the protection level.

1-2 S8AS Operating Modes

The S8AS has 3 operating modes: Run Mode, Setting Mode, and Test Mode.

Run Mode	The output voltage, output current, internal temperature, and run time are monitored while supplying 24 VDC to the branch outputs. The monitored values can be displayed on the seven-segment display. The S8AS automatically starts in Run Mode when the S8AS is used for the first time.
Setting Mode	This mode is used to set parameters. Branch output connections are the same as in Run Mode.
Test Mode (See note.)	This mode is used to test operation. The factory default setting for all outputs is ON, so any branch outputs that are not being used must be turned OFF in Test Mode.

Note Test Mode can be entered only in protection level 0 or 1.

Changing the Operating Mode

To change the operating mode, press the Up (SEL) (⏶) and Down (CH) (⏷) Keys simultaneously for 3 s. The Mode Selection Menu will be displayed. Use the Up (SEL) Key to select the desired operating mode and then press the Enter (⏵) Key.

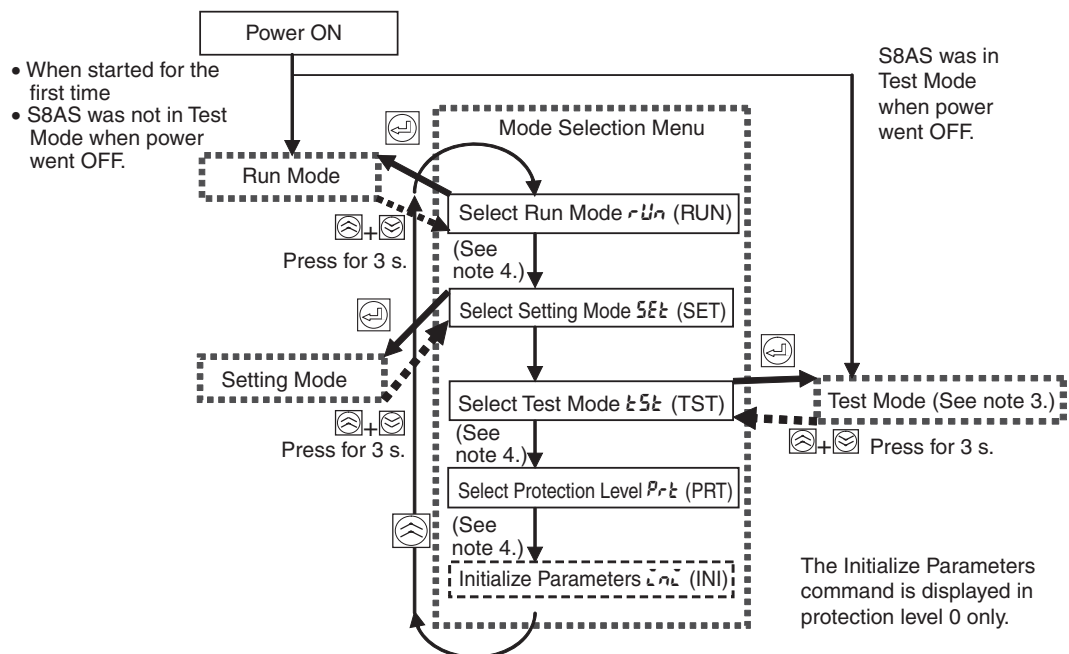

- Note**
- (1) The Protection Level function can restrict parameter read/write access to one of three levels. For details, refer to 4-3 *Changing the Protection Level*.
 - (2) The Initialize Parameters function restores all of the S8AS's parameter settings to their default values. For details on default values, refer to 4-1 *Parameter Table*.
 - (3) Test Mode can be entered only in protection level 0 or 1.
 - (4) The Setting Mode, Protection Level, or Parameter Initialization options cannot be accessed with models such as S8AS-24006N/48008N that do not permit changes in parameter settings.

Turning the Power ON for the First Time

- When a newly purchased S8AS is turned ON for the first time, it will enter Run Mode with all the branch outputs turned ON. To change parameter settings, return to the Mode Selection Menu and switch to Setting Mode. Refer to *SECTION 4 Parameter Settings* for details on setting parameters.
- To start trial operation or to set branch output connections after setting the parameters, return to the Mode Selection Menu and switch to Test Mode. Refer to *SECTION 5 Trial Operation to Actual Operation* for details on the operations in Test Mode.
- When changing to Run Mode after completing trial operation, return to the Mode Selection Menu and switch to Run Mode. If the power is turned OFF while the S8AS is in Test Mode, the S8AS will enter Test Mode again the next time that the power is turned ON. All branch outputs will retain the connection status they had before the power was turned OFF.

Normal Power-ON Procedure

If the S8AS has been turned ON already, it will enter Run Mode or Test Mode the next time that power is turned ON. If the S8AS was in Test Mode when the power went OFF, it will start in Test Mode. If it was in a mode other than Test Mode when the power went OFF, it will start in Run Mode.

In addition to selecting the operating mode, the Mode Selection Menu can be used to select the protection level and initialize the parameters (see note 2). (These options cannot be selected when using the S8AS-24006N/48008N.)

The Initialize Parameters function restores all of the S8AS's parameter settings to their default values. For details on default values, refer to *Turning the Power ON for the First Time*.

Automatic Operation after Power ON

When the rated voltage (100 to 240 VAC, 50/60 Hz) is applied to the AC input terminal block, the S8AS performs self-diagnostics (hardware and software checks) for approximately 3 seconds. ("AS" will flash on the seven-segment display during the self-diagnostic process.) If no errors are detected, the S8AS will immediately start connecting the branch outputs.

Branch outputs will not be connected if they were not set to ON in Test Mode. Furthermore, if the startup sequence function (refer to *2-5 Startup Sequence Function*) has been set, the branch outputs will be connected according to their corresponding settings.

Operation in Run Mode

In Run Mode, the S8AS continuously measures the output voltage, branch output circuit currents, and internal temperature, and compares these values to the set values (both user-set parameters and system set values).

Monitor Operation

The monitored output voltage, branch output currents, branch output peak current, total current, internal temperature, and replacement time can be read on the S8AS's seven-segment display. The displayed value can be switched with the Up (SEL) Key (⏶) and Down (CH) Key (⏷).

Tripping Operation

If the voltage or current is abnormal, the branch output will be cut off to protect the circuit.

■ Abnormal Voltage Tripping

All branch outputs will be cut off if the output voltage exceeds 28.8 VDC in order to protect the load devices.

■ Abnormal Current Tripping

A branch output will be cut off if the tripping current threshold (see note) or an abnormal current is detected using the specified current detection method (see note). (The tripping current threshold and current detection method cannot be changed for the S8AS-24006N/48008N.)

An error code will be displayed, and the tripping alarm output will operate when a branch output is cut off.

Other Status Monitoring

The internal temperature and replacement time status are monitored and error processing is performed if an error is detected.

Operation in Setting Mode

Setting Mode can be used to set the various parameters. The S8AS is in operating status when it is in Setting Mode. Branch outputs are connected in Setting Mode in the same way as in Run Mode. When an error is detected, branch outputs will be cut off and alarms will be output, just as they are in Run Mode.

Note If an error occurs in Setting Mode, the error code is not displayed.

Operation in Test Mode

In Test Mode, each branch output can be set to ON or OFF (connected or disconnected).

The factory default setting for all outputs is ON, so any branch outputs that are not being used must be turned OFF in Test Mode.

In Test Mode, the operation of each branch circuit can be verified as well as the operation of the startup sequence and shutdown sequence.

Note (a) If the power is turned OFF while the S8AS is in Test Mode, the S8AS will enter Test Mode again the next time that the power is turned ON.

(b) When an error occurs in Test Mode, branch outputs will be cut off and external signals will be output, just as they are in Run Mode. The error code will not be displayed.

(c) Refer to 7-3 *Clearing Errors* for details on clearing errors.

Note

(1) When the S8AS is shipped from the factory, all branch outputs are set to ON (connected) and the S8AS will enter Run Mode when the power is turned ON. After setting the parameters that require changing, switch to Test Mode, set the switching status of the required branch outputs, and then switch to Run Mode.

(2) If a branch output is OFF (disconnected) when the mode is changed from Test Mode to Run Mode, it will not be connected (ON) in Run Mode.

(3) If the power is turned OFF while the S8AS is in Test Mode, the S8AS will start in Test Mode the next time that the power is turned ON, but all branch outputs will be OFF.

1-3 Table of Basic Functions

Monitor Functions

Monitored parameter	Details	Indications		
		Seven-segment display	Branch output number indicators	Unit indicators
Output voltage	Displays the output voltage.	16.3 to 30.0	Not lit	V
Total current	Displays the sum of all the branch output currents.	0.0 to 40.0	All branches lit	A
Branch output current	Displays individual branch output currents.	0.0 to 20.0	Lit	A
Branch output peak current	Displays individual branch output peak currents.	0.0 to 20.0	Lit	A (flashing)
Replacement time	Displays the estimated number of years left until the S8AS needs to be replaced. (Setting: 0.0 to 5.0 years, in 0.5-year increments.)	FUL, HLF 0.0 to 5.0	Not lit	Yrs
Internal temperature	Displays the S8AS's internal temperature.	-20 to 100	Not lit	°C

Setting Functions

Refer to *SECTION 4 Parameter Settings* for details on parameter settings. (These parameters cannot be changed for the S8AS-24006N/48008N.)

Data name	Detail	Setting range
Undervoltage detection threshold	The undervoltage detection output (LOW) is output when the output voltage of the S8AS falls below this detection threshold. The detection threshold can be set in 0.1-V increments. Branch outputs will not be cut off.	18.0 to 26.4 V
Abnormal current tripping threshold	The current tripping threshold can be set for each branch output in 0.1-A increments.	0.5 to 3.8 A
Abnormal current tripping type	The tripping type can be set for each branch output. USU: Standard (tripping within 100 ms) INS: Instantaneous (tripping within 20 ms) LNG: Extended (tripping within 1,000 ms)	USU/INS/LNG
Maintenance forecast monitor function	Set the expected number of years until the S8AS needs to be replaced. When the estimated value falls below the set value, the maintenance forecast monitor output (LFE) will turn ON. (The photoswitch output will turn OFF.)	0.0 to 5.0 yr
Over-temperature threshold	An excessive temperature rise inside the S8AS will be detected and the over-temperature output (TMP) will turn ON. (The photoswitch output will turn OFF.) This output can be used to control cooling equipment to reduce the temperature in the control panel.	25 to 90°C
Startup sequence	The connection of branch outputs may be initiated by communications or when the power is turned ON, and a time delay can be set for the connection sequence. Connecting the branch outputs in sequence instead of simultaneously can reduce the inrush current and reduce the load on the Power Supply.	0.0 to 99.9 s

Data name	Detail	Setting range
Shutdown sequence	Branch outputs can be disconnected in sequence initiated by communications or an external tripping input (TRP), and a time delay can be set for the sequence.	0.0 to 99.9 s
Tripping trigger input	The external tripping input function (TRG) can be enabled (ON) or disabled (OFF) for each branch output.	OFF, ON
Tripping trigger type	The tripping trigger type can be set for all branches that have the tripping input function enabled.	EGE, LVL
Protection level	The Protection Level function can restrict parameter read/write access by setting one of three levels. The default protection level is level 1.	0 to 2
Reset operation	The tripping alarm output and alarm output can be cleared after removing the cause of the alarm by the following two methods. <ul style="list-style-type: none"> • KEY: RST Key only. • ALL: RST Key or turning power OFF and ON again. 	KEY, ALL

**Tripping/
Alarm Functions**

There are three ways for the S8AS's tripping function to operate:

- Tripping by user-set parameters
- Tripping by the S8AS's system monitor
- Tripping by external operation

The external signal outputs include the Tripping Alarm Output (TRP), Under-voltage Detection Output (LOW), Maintenance Forecast Monitor Output (LFE), and Over-temperature Output (TMP).

Tripping Functions

Setting	Operating range	Parameter settings	Outputs cut off
Abnormal voltage tripping	Output cut off for voltage over 28.8 VDC.	None	All branch outputs
Short-circuit current tripping	Output cut off at 16 A for 20 ms max. Output cut off at 11 A for 60 ms max.	None	Individual branch output
Abnormal total current tripping	Output cut off when the sum of all branch output currents exceeds the set value for a specific length of time.	None	All branch outputs
Abnormal current tripping (See note 1.)	0.5 to 3.8 A (in 0.1-A increments) Select from standard, instantaneous, and extended detection methods.		Individual branch output
External tripping input	<ul style="list-style-type: none"> • External input signal (TRG) ON • Tripping by communications. 		Specified output (See note 2.)

- Note**
- (1) The tripping function operates within 100 ms when the S8AS is set to standard detection, within 20 ms when it is set to instantaneous detection, and within 1,000 ms when it is set to extended detection.
 - (2) The TRG signal applies only to the branch outputs for which the external tripping input is enabled. For details, refer to *2-7 External Tripping Input Function*.

Alarm Output and Error Display Functions

Symbol	Output name	Operation	Error code displayed
TRP	Tripping alarm output	Abnormal Voltage Tripping Operation When the output voltage exceeds 28.8 VDC, all branch outputs are cut off and the TRP output is turned ON. (The photoswitch output is turned OFF.)	A10
		Abnormal Current Tripping Operation When the branch output current exceeds the set value, the branch output is cut off and the TRP output is turned ON. (The photoswitch output is turned OFF.)	A11/Current (alternating)
		Volt-amperage (VA) Tripping Operation When the voltage times the current (VA) exceeds the set value for a specified amount of time, the branch output is cut off and the TRP output is turned ON. (The photoswitch output is turned OFF.)	A11/Current (alternating)
		Abnormal Total Current Tripping Operation When the total output current exceeds the set value, all branch outputs are cut off and the TRP output is turned ON. (The photoswitch output is turned OFF.)	A12
		Indicates that there are branch outputs that are not connected. This error is not output in any mode other than Test Mode. When there is a disconnected branch output in Test Mode, the TRP output is turned ON. (The photoswitch output is turned OFF.)	---
LOW	Undervoltage detection output	Setting range: 18.0 to 26.4 VDC (0.1-V increments) When the output voltage falls below the set value, the LOW output is turned ON. (The photoswitch output is turned OFF.)	A21/Voltage (alternating)
LFE	Maintenance forecast monitor output	Setting range: 0.0 to 5.0 years (0.5-yr increments) (See note 1.) When the internally calculated replacement time falls below the set value, the LFE output is turned ON. (The photoswitch output is turned OFF.)	A23/Replacement time (alternating)
	Overheating alarm (See note 2.)	LFE output is turned ON (the photoswitch output is turned OFF) when the replacement time cannot be calculated correctly due to rise in internal temperature.	A23/HOT (alternating)
TMP	Over-temperature output	Setting range: 25 to 90°C (1°C increments) When the temperature falls below the set value minus 3°C, the TMP output and the error code shown on the seven-segment display will be automatically cleared.	A30/Temperature (alternating)

Note

- (1) In this manual, the lifetime of the Unit is expressed in years.
- (2) If the overheating alarm stays on for more than 3 hours, it can no longer be cleared.

1-4 S8AS Operating Procedure

Using the S8AS

Typical Startup Procedure Using the S8AS's Keys

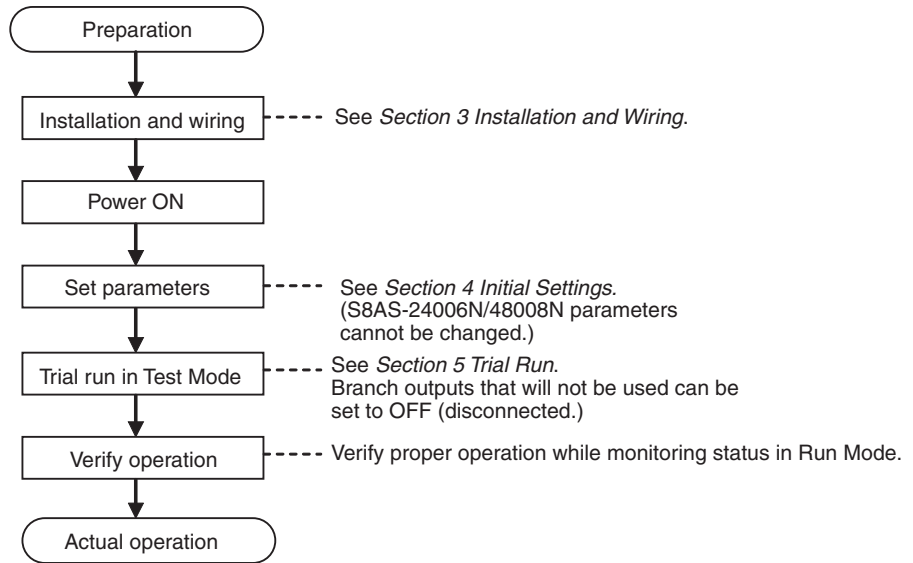

Summary of Application Objectives and Settings

Desired objective/usage	Settings	Details
Use as a circuit breaker with overcurrent tripping.	In Setting Mode, set the abnormal current tripping threshold (C-V) for the branch output being used and set the abnormal current tripping detection setting (C-T) to standard detection (USU).	p. 30, p. 62
Use as a circuit breaker for short-circuit current protection.	In Setting Mode, set the abnormal current tripping threshold (C-V) for the branch output being used and set the abnormal current tripping detection setting (C-T) to instantaneous detection (INS).	
Detect a drop in power supply voltage.	In Setting Mode, set the undervoltage detection threshold (V-U). Take the alarm signal from the Undervoltage Detection Output (LOW) terminal. When an undervoltage is detected, the seven-segment display will show error code A21 and the LOW output photoswitch output will go OFF.	p. 29, p. 50, p. 63
Apply a separate time lag when connecting each branch output.	In Setting Mode, set the startup sequence (UPS).	p. 37, p. 66
Apply a separate time lag when cutting off each branch output.	In Setting Mode, set the shutdown sequence (DWS) and enable the External Tripping Input (TRG).	p. 38, p. 67
Use the S8AS replacement time for better maintenance.	The seven-segment display and the LFE terminal signal output can be used to check the estimated replacement time using the maintenance forecast monitor function.	p. 34, p. 64

Desired objective/ usage	Settings	Details
Monitor temperature rise in control panel and prevent overheating.	In Setting Mode, set the over-temperature output threshold (TMP). Take the signal from the Over-temperature Output (TMP) terminal and use that signal to operate a fan or air conditioner.	p. 35, p. 65 p. 50
Restrict read/write access of parameters to prevent mistaken operations.	Select the protection level setting (PRT) from the Mode Selection Menu and set the desired protection level.	p. 54, p. 59

SECTION 2

Specifications and Functions

This section provides the specifications of the S8AS and describes special S8AS functions.

2-1	Component Names and Functions	16
2-2	Internal Configuration	20
2-3	Specifications	22
2-4	Basic Function Details	29
2-4-1	Voltage Monitoring and Protection Functions	29
2-4-2	Over-current Protection Functions	30
2-4-3	Maintenance Forecast Monitor Function	34
2-4-4	Over-temperature Output	35
2-5	Startup Sequence Function	37
2-6	Shutdown Sequence Function	38
2-7	External Tripping Input Function	39

2-1 Component Names and Functions

Component Names

■ 240-W Output Models

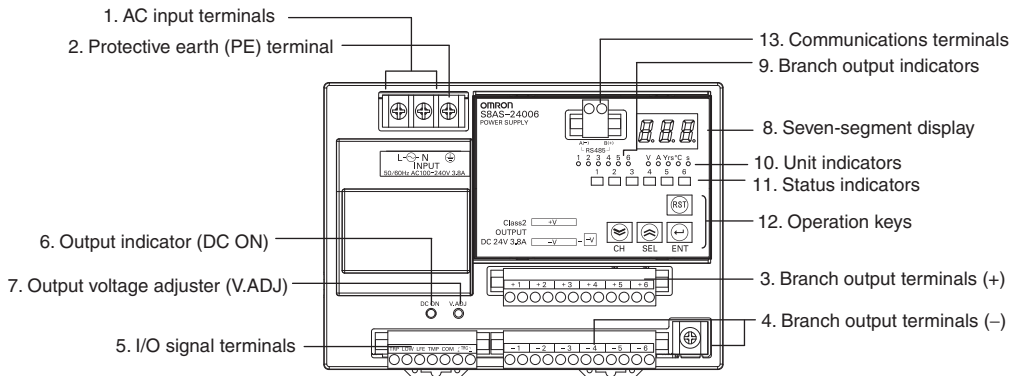

■ 480-W Output Models

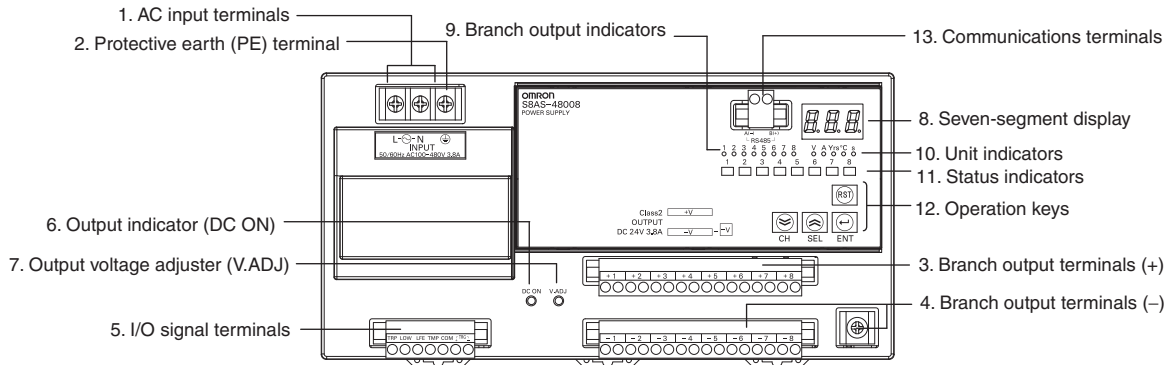

(1) AC Input Terminals (L and N) and (2) Protective Earth (PE) Terminal

Connect the input power supply (100 to 240 VAC, 50/60 Hz) (commercial power) to the Power Supply.

Do not connect an inverter output as the power supply.

Make sure that the protective earth (PE) terminal is connected to ground to prevent electric shock or malfunction.

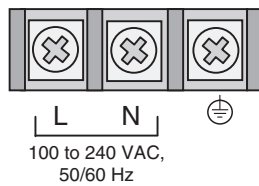

(The terminal screws are M4.)

(3) Positive (+) and (4) Negative (-) Branch Output Terminals

Connect to each branch output. Positive and negative branch outputs are connected to separate terminal blocks with two positive and two negative terminals for each branch output.

• 240-W Model Output Terminals

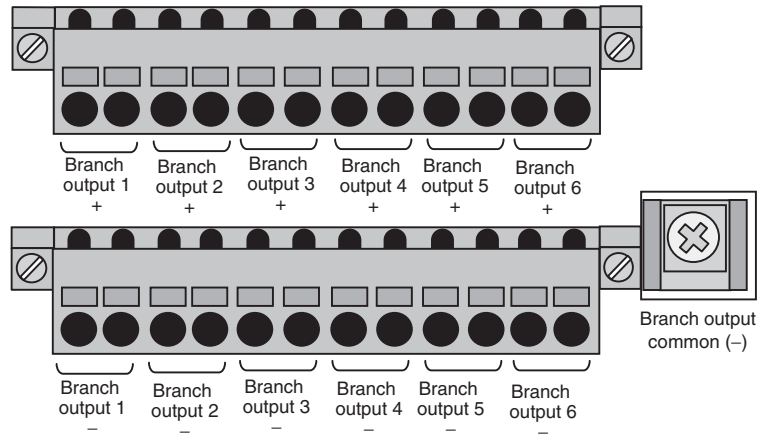

• 480-W Model Output Terminals

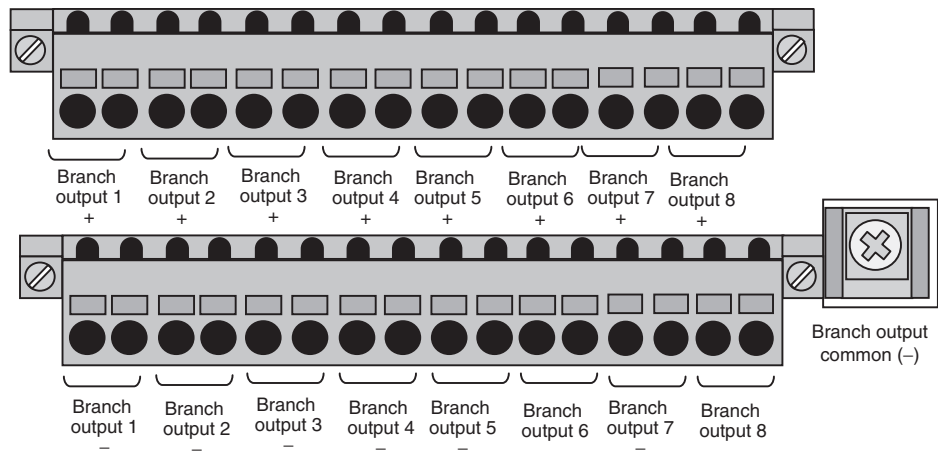

(5) I/O Signal Terminals

Connect the external outputs and external tripping inputs.

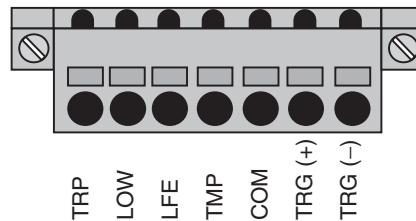

TRP	Tripping Alarm Output	Turns ON to indicate when an abnormal voltage or current was detected and the output was cut off (The photoswitch output will turn OFF.).
LOW	Undervoltage Detection Output	Turns ON when the 24-VDC output voltage from the S8AS falls below the threshold. (The photoswitch output will turn OFF.).
LFE	Maintenance Forecast Monitor Output	Turns ON to indicate when the number of years to the set replacement time has been reached (The photoswitch output will turn OFF.).
TMP	Over-temperature Output	Turns ON to indicate that the temperature exceeded the over-temperature output threshold (The photoswitch output will turn OFF.).

COM	Common Terminal	Common terminal shared by the four alarm outputs above.
TRG (+) TRG (-)	External Tripping Input	Can be used to send an input signal from an external device to cut off a branch output.

(6) Output Indicator (DC ON)

The indicator is lit green when the S8AS is in normal operation. It indicates that the 24 VDC output can be used as a supply voltage.



(7) Output Voltage Adjuster (V.ADJ)

The output voltage is set at a default of the 24-VDC rated voltage. Use the output voltage adjuster to adjust the output voltage.



The adjustable range is -10% to +10 % of the rated output voltage. Turning the adjuster clockwise increases the output voltage, and turning it counterclockwise decreases the output voltage.

Note

- (1) If the output voltage is set to less than 20.0 V (default setting), the under-voltage detection may be activated.
- (2) Do not exceed the rated output capacity and rated total output current after adjusting the output voltage.
- (3) The output voltage may increase beyond the allowable voltage range (rated voltage +10%) when the V.ADJ adjuster is used. When adjusting the output voltage, check the output voltage of the power supply to make sure that the load is not damaged.
- (4) Do not use excessive force to turn the adjuster (V.ADJ). It may be damaged.

(8) Seven-segment Display (Red)

Displays measured values or set values on a 3-digit LED display.



(9) Branch Output Indicators (Orange)

(10) Unit Indicators (Orange)

Shows the branch output number and the unit for the value shown in the seven-segment display.

- Six-branch Output Model

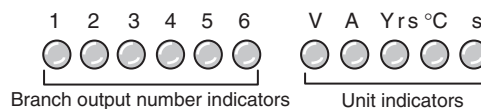

1 to 6: 240 W 1 to 8: 480 W	Lit or flashing when the display is related to the corresponding branch output.
V	Lit when displaying the output voltage.
A	Lit when displaying the output current. Flashes when displaying the peak output current.
Yrs	Lit when the number of years to the set replacement time is displayed.

°C	Lit when displaying the temperature.
s	Lit when setting the startup sequence time or shutdown sequence time.

(11) Status indicators (Green/Red)





Indicate the connection and cut off status for the branch outputs.

- Six-branch Output Model



Not lit		Not connected	Set to OFF (disconnected) or forcibly cut off by command.
Green	Lit	Connected	Connected normally.
	Flash	Not connected	In the startup sequence and waiting for connection.
Red	Lit	Cut off	Cut off due to an error.
	Flash	Cut off	Cut off by an internal error.

(12) Operation Keys

Reset (RST) Key 	Used to clear the error status when a branch output was cut off by an error or there was an alarm output.
Enter (ENT) Key 	Used to switch the display item, enter or execute settings, etc.
Up (SEL) Key 	Used to change the display item forward or to increase a set value.
Down (CH) Key 	Used to switch the branch output or to decrease a set value. The branch output number that is set remains the same in other modes.

(13) Communications Terminals (A (-), B (+)) (Only for Models That Support Communications)

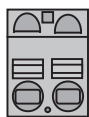

A (-) B (+)

Used to connect to the RS-485 communications line.

2-2 Internal Configuration

S8AS-24006 (Model with NO Communications and Changeable Parameter Settings)

S8AS-24006N (Model with NO Communications and Unchangeable Parameter Settings)

S8AS-24006R (Model with Communications and Changeable Parameter Settings)

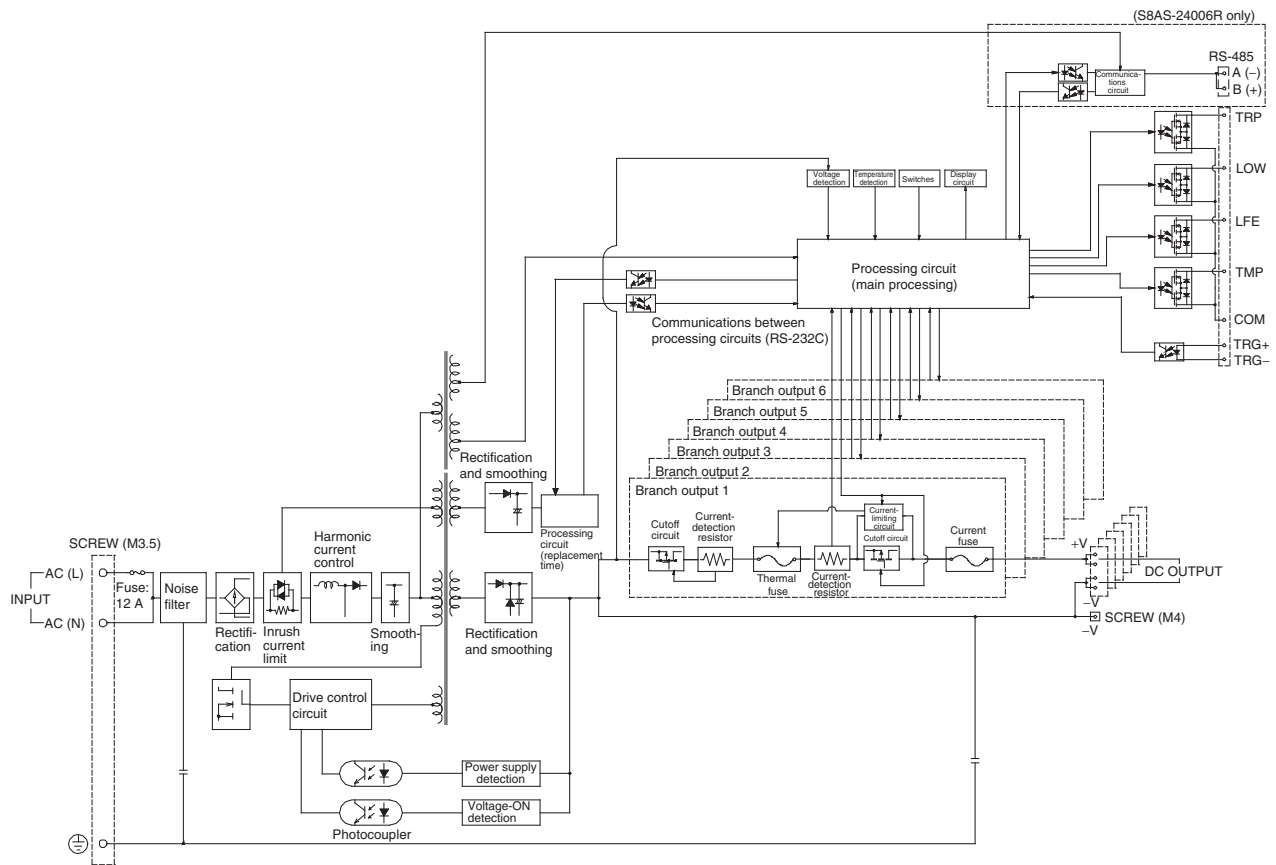

S8AS-48008 (Model with NO Communications and Changeable Parameter Settings)

S8AS-48008N (Model with NO Communications and Unchangeable Parameter Settings)

S8AS-48008R (Model with Communications and Changeable Parameter Settings)

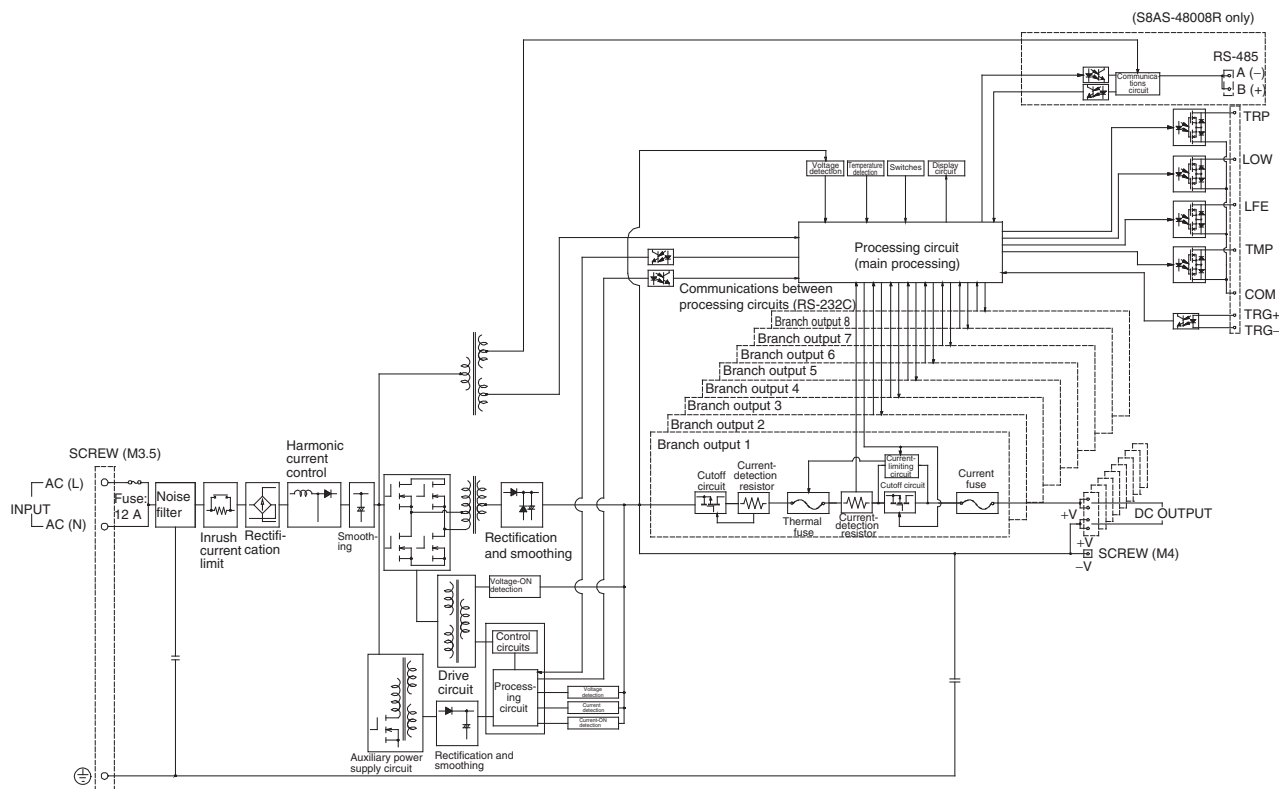

- The S8AS compares the measured input voltage, current, and internal temperature with the preset parameters. These values can be read on the S8AS's seven-segment display.
- When an error is detected, the branch output will be cut off or an alarm will be output. The error code and PV will be displayed alternately on the seven-segment display.
- When an abnormal voltage or current is detected, the semiconductor relay will cut off the branch output. In the unlikely event that the semiconductor relay cannot cut off an abnormal current or short-circuit current, the redundant protection circuit, and the short-circuit protection fuse (12.0 A minimum) will operate to protect the system.
- The S8AS has a built-in temperature sensor, which can detect a temperature rise inside the S8AS. When the internal temperature exceeds the detection threshold, the Over-temperature Output (TMP) photoswitch output will turn OFF.
- When an internal circuit has failed, the components can generate excessive heat. As a safety precaution against this kind of failure, the S8AS is equipped with a function that cuts off operation using a thermal fuse.

Models that support communications have a RS-485 port, and can be connected to a host computer.

2-3 Specifications

Ratings and Characteristics

S8AS-24006□

Item	Model	S8AS-24006	S8AS-24006N	S8AS-24006R	
Efficiency (Typ.)		80% min.			
Input conditions	Voltage range (See note 1.)	100 to 240 VAC (85 to 264 VAC)			
	Frequency (See note 1.)	50/60 Hz (47 to 63 Hz)			
	Current	100-V input	3.8 A max.		
		200-V input	2.0 A max.		
	Power factor	0.95 min.			
	Harmonic current	EN61000-3-2			
	Leakage current	100-V input	0.5 mA max.		
		200-V input	1.0 mA max.		
Inrush current (See note 2.)	100-V input	25 A max. (for a cold start at 25°C)			
	200-V input	50 A max. (for a cold start at 25°C)			
Output conditions	Number of branches	6			
	Maximum cutoff output current (per branch)	3.8 A			
	Total output current	10 A			
	Allowable voltage range (See note 3.)	±10 A (with V.ADJ)			
	Ripple noise voltage	2.0%[P-P] max. (for rated input and output voltage) (See note 4.)			
	Output leakage current	10 mA max.			
	Input fluctuation	0.5 % max. (Input: 85 to 264 VAC, 100 % load) (See note 5.)			
	Load fluctuation (rated input voltage)	4.0 % max. (rated input, 0% to 100% load) (See note 5.)			
	Temperature fluctuation	0.05%/°C max.			
	Startup time (See note 2.)	3,000 ms max. (for rated input and output voltage) (See note 4.)			
	Output hold time (See note 2.)	20 ms min. (for rated input and output voltage) (See note 4.)			
Functions	Tripping functions	Abnormal voltage tripping	28.8 V (Cannot be changed.)		
		Abnormal current tripping (See note 2.)	Setting range: 0.5 to 3.8 A (in 0.1-A increments)	3.8 A (Cannot be changed.)	Setting range: 0.5 to 3.8 A (in 0.1-A increments)
		Abnormal total current tripping	Branch outputs are cut off when the total output current is more than 17 A for 2 s, 15 A for 5 s, 13 A for 10 s, or 12 A for 20 s.		
		Tripping Alarm Output	Photoswitch output 30 VDC max. and 50 mA max., Leakage current: 0.1 mA max., Residual voltage: 2 V max.		
	Undervoltage detection functions	Undervoltage detection	Setting range: 18.0 to 26.4 V (in 0.1-V increments)	20.0 V (Cannot be changed.)	Setting range: 18.0 to 26.4 V (in 0.1-V increments)
		Undervoltage detection output	Photoswitch output 30 VDC max. and 50 mA max., Leakage current: 0.1 mA max., Residual voltage: 2 V max.		
	Maintenance forecast monitor function	Maintenance forecast monitor	Setting range: 0.0 to 5.0 yr (in 0.5-yr increments)	0.5 yr (Cannot be changed.)	Setting range: 0.0 to 5.0 yr (in 0.5-yr increments)
		Maintenance forecast monitor output	Photoswitch output 30 VDC max. and 50 mA max., Leakage current: 0.1 mA max., Residual voltage: 2 V max.		

Item	Model	S8AS-24006	S8AS-24006N	S8AS-24006R	
Functions	Over-temperature detection function	Over-temperature	Setting range: 25 to 90°C (in 1°C increments)	90°C (Cannot be changed.)	Setting range: 25 to 90°C (in 1°C increments)
		Over-temperature output	Photoswitch output 30 VDC max. and 50 mA max., Leakage current: 0.1 mA max., Residual voltage: 2 V max.		
	Display functions	Output voltage display	Display range: 17.0 to 30.0 V Display accuracy: 2% rdg ±1 digit max.		
		Output current display	Branch output display range: 0.0 to 4.0 A Peak output current display range: 0.0 to 20.0 A Total current display range: 0.0 to 40.0 A Display accuracy: 5% FS (4 A) ±1 digit max.		
		Maintenance forecast monitor display	Display range: FUL (Full)/HLF (Half)/0.0 to 5.0 yr		
		Temperature display	Display range: -20 to 100°C Display accuracy: 2°C ±1 digit max.		
	External Tripping Input		The input can be enabled or disabled for each branch output. 19.2 to 30 VDC, minimum signal width: 10 ms, tripping after input within 20 ms + the shutdown sequence set time	All branch outputs: Enabled (Cannot be changed.) 19.2 to 30 VDC, minimum signal width: 10 ms, tripping after input within 20 ms + the shutdown sequence set time	The input can be enabled or disabled for each branch output. 19.2 to 30 VDC, minimum signal width: 10 ms, tripping after input within 20 ms + the shutdown sequence set time
	Startup sequence		Setting range: 0.0 to 99.9 s in 0.1-s increments	Branch output 1: 0.0 s (Cannot be changed.) Branch output 2: 0.4 s (Cannot be changed.) Branch output 3: 0.8 s (Cannot be changed.) Branch output 4: 1.2 s (Cannot be changed.) Branch output 5: 1.6 s (Cannot be changed.) Branch output 6: 2.0 s (Cannot be changed.)	Setting range: 0.0 to 99.9 s in 0.1-s increments
	Shutdown sequence		Setting range: 0.0 to 99.9 s in 0.1-s increments	All branch outputs: 0.0 s (Cannot be changed.)	Setting range: 0.0 to 99.9 s in 0.1-s increments
	Communications		Not supported		Supported (RS-485)
	Sampling period		1 ms		
	Parallel connection		Not supported.		
	Series connection		Not supported.		

Item	Model	S8AS-24006	S8AS-24006N	S8AS-24006R
Others	Ambient operating temperature	Refer to the derating curve (no icing or condensation). (See note 2.)		
	Storage temperature	-25 to 65°C		
	Ambient operating humidity	25% to 85% (storage: 25% to 90%)		
	Withstand voltage	3.0 kVAC for 1 min between all input terminals collectively and all branch output, all I/O signal, and all communications terminals collectively (Detection current: 20 mA) 2.0 kVAC for 1 min between all inputs and protective earth (Detection current: 20 mA) 1.0 kVAC for 1 min between protective earth and all branch output, all I/O signal, and all communications terminals collectively (Detection current: 20 mA) 500 VAC for 1 min between all branch output and all I/O signal/communications terminals collectively (Detection current: 20 mA) 500 VAC for 1 min between all I/O signal terminals collectively and communications terminals collectively (Detection current: 20 mA) 500 VAC for 1 min between all I/O signal terminals collectively and all output signal terminals collectively (detection current: 20 mA)		
	Insulation resistance	100 MΩ min. at 500 VDC between the protective earth terminal or all input terminals collectively and all branch output, all I/O signal, and all communications terminals collectively		
	Vibration resistance	No abnormality after 10 to 55 Hz at 0.375-mm single amplitude for 2 h each in 3 directions.		
	Shock resistance	No abnormality after 150 m/s ² 3 times each in 6 directions.		
	Output indicator	Provided (Color: green)		
	Conducted EMI	Conforms to EN 61204-3 Class A and FCC Class A.		
	Radiated EMI	Conforms to EN 61204-3 Class A.		
	Safety standards	cULus: UL508 (Listing. Class2: Per UL1310), CSA C22.2 No.107.1 (Class2: Per CSA C22.2 No.223) cURus: UL60950-1, CSA C22.2 No.60950-1 EN: EN50178, EN60950-1 VDE: VDE0160, VDE0805 Teil1		
	Weight	1,600 g max.		

- Note**
- (1) Do not use an inverter output for the Power Supply. Inverters with an output frequency of 50/60 Hz are available, but the rise in the internal temperature of the Power Supply may result in ignition or burning.
 - (2) Refer to *Derating Curve* on page xiv for details.
 - (3) If the output voltage adjuster (V. ADJ) is turned, the voltage will increase by more than 10% of the voltage adjustment range. When adjusting the output voltage, confirm the actual output voltage from the Power Supply and be sure that the load is not damaged. If the output voltage exceeds 28.8 V, all branch outputs will be cut off.
 - (4) Rated input and output conditions: Rated input voltage, rated frequency, rated output voltage, rated total output current, and maximum cutoff output current.
 - (5) 100% load conditions: Rated output voltage, rated total output current, and maximum cutoff output current.

S8AS-48008□

Item	Model	S8AS-48008	S8AS-48008N	S8AS-48008R	
Efficiency (Typ.)		80% min.			
Input conditions	Voltage range (See note 1.)		100 to 240 VAC (85 to 264 VAC)		
	Frequency (See note 1.)		50/60 Hz (47 to 63 Hz)		
	Current	100-V input	7.4 A max.		
		200-V input	3.9 A max.		
	Power factor		0.95 min.		
	Harmonic current		EN61000-3-2		
	Leakage current	100-V input	0.5 mA max.		
		200-V input	1.0 mA max.		
Inrush current (See note 2.)	100-V input	25 A max. (for a cold start at 25°C)			
	200-V input	50 A max. (for a cold start at 25°C)			
Output conditions	Number of branches		8		
	Maximum cutoff output current (per branch)		3.8 A		
	Total output current		20 A		
	Allowable voltage range (See note 3.)		±10 A (with V.ADJ)		
	Ripple noise voltage		2.0%[P-P] max. (for rated input and output voltage) (See note 4.)		
	Output leakage current		10 mA max.		
	Input fluctuation		0.5 % max. (Input: 85 to 264 VAC, 100 % load) (See note 5.)		
	Load fluctuation (rated input voltage)		4.0 % max. (rated input, 0% to 100% load) (See note 5.)		
	Temperature fluctuation		0.05%/°C max.		
	Startup time (See note 2.)		3,000 ms max. (for rated input and output voltage) (See note 4.)		
	Output hold time (See note 2.)		20 ms max. (for rated input and output voltage) (See note 4.)		
Functions	Tripping functions	Abnormal voltage tripping	28.8 V (Cannot be changed.)		
		Abnormal current tripping (See note 2.)	Setting range: 0.5 to 3.8 A (in 0.1-A increments)	3.8 A (Cannot be changed.)	Setting range: 0.5 to 3.8 A (in 0.1-A increments)
		Total abnormal current tripping	Branch outputs are cut off when the total output current is more than 27 A for 1 s, 25 A for 2 s, or 22.5 A for 5 s.		
		Tripping Alarm Output	Photoswitch output 30 VDC max. and 50 mA max., Leakage current: 0.1 mA max., Residual voltage: 2 V max.		
	Undervoltage detection functions	Undervoltage detection	Setting range: 18.0 to 26.4 V (in 0.1-V increments)	20.0 V (Cannot be changed.)	Setting range: 18.0 to 26.4 V (in 0.1-V increments)
		Undervoltage detection output	Photoswitch output 30 VDC max. and 50 mA max., Leakage current: 0.1 mA max., Residual voltage: 2 V max.		
	Maintenance forecast monitor function	Maintenance forecast monitor	Setting range: 0.0 to 5.0 yr (in 0.5-yr increments)	0.5 yr (Cannot be changed.)	Setting range: 0.0 to 5.0 yr (in 0.5-yr increments)
		Maintenance forecast monitor output	Photoswitch output 30 VDC max. and 50 mA max., Leakage current: 0.1 mA max., Residual voltage: 2 V max.		

Item	Model	S8AS-48008	S8AS-48008N	S8AS-48008R	
Functions	Over-temperature detection function	Over-temperature threshold	Setting range: 25 to 90°C (in 1°C increments)	90°C (Cannot be changed.)	Setting range: 25 to 90°C (in 1°C increments)
		Over-temperature output	Photoswitch output 30 VDC max. and 50 mA max., Leakage current: 0.1 mA max., Residual voltage: 2 V max.		
	Display functions	Output voltage display	Display range: 17.0 to 30.0 V Display accuracy: 2% rdg ±1 digit max.		
		Output current display	Branch output display range: 0.0 to 4.0 A Peak output current display range: 0.0 to 20.0 A Total current display range: 0.0 to 40.0 A Display accuracy: 5% FS (4 A) ±1 digit max.		
		Maintenance forecast monitor display	Display range: FUL (Full)/HLF (Half)/0.0 to 5.0 yr		
		Temperature display	Display range: -20 to 100°C Display accuracy: 2°C ±1 digit max.		
	External Tripping Input	The input can be enabled or disabled for each branch output. 19.2 to 30 VDC, minimum signal width: 10 ms, tripping after input within 20 ms + the shutdown sequence set time	All branch outputs: Enabled (Cannot be changed.) 19.2 to 30 VDC, minimum signal width: 10 ms, tripping after input within 20 ms + the shutdown sequence set time	The input can be enabled or disabled for each branch output. 19.2 to 30 VDC, minimum signal width: 10 ms, tripping after input within 20 ms + the shutdown sequence set time	
	Startup sequence	Setting range: 0.0 to 99.9 s in 0.1-s increments	Branch output 1: 0.0 s (Cannot be changed.) Branch output 2: 0.4 s (Cannot be changed.) Branch output 3: 0.8 s (Cannot be changed.) Branch output 4: 1.2 s (Cannot be changed.) Branch output 5: 1.6 s (Cannot be changed.) Branch output 6: 2.0 s (Cannot be changed.) Branch output 7: 2.4 s (Cannot be changed.) Branch output 8: 2.8 s (Cannot be changed.)	Setting range: 0.0 to 99.9 s in 0.1-s increments	
	Shutdown sequence	Setting range: 0.0 to 99.9 s in 0.1-s increments	All branch outputs: 0.0 s (Cannot be changed.)	Setting range: 0.0 to 99.9 s in 0.1-s increments	
	Communications	Not supported		Supported (RS-485)	
Sampling period	1 ms				
Parallel connection	Not supported.				
Series connection	Not supported.				

Item	Model	S8AS-48008	S8AS-48008N	S8AS-48008R
Others	Ambient operating temperature	Refer to the derating curve (no icing or condensation). (See note 2.)		
	Storage temperature	-25 to 65°C		
	Ambient operating humidity	25% to 85% (storage: 25% to 90%)		
	Withstand voltage	3.0 kVAC for 1 min between all input terminals collectively and all branch output, all I/O signal, and all communications terminals collectively (detection current: 20 mA) 2.0 kVAC for 1 min between all inputs and protective earth (Detection current: 20 mA) 1.0 kVAC for 1 min between protective earth and all branch output, all I/O signal, and all communications terminals collectively (Detection current: 30 mA) 500 VAC for 1 min between all branch output and all I/O signal/communications terminals collectively (Detection current: 20 mA) 500 VAC for 1 min between all I/O signal terminals collectively and communications terminals collectively (Detection current: 20 mA) 500 VAC for 1 min between all I/O signal terminals collectively and all output signal terminals collectively (detection current: 20 mA)		
	Insulation resistance	100 MΩ min. at 500 VDC between the protective earth terminal or all input terminals collectively and all branch output, all I/O signal, and all communications terminals collectively		
	Vibration resistance	No abnormality after 10 to 55 Hz at 0.375-mm single amplitude for 2 h each in 3 directions.		
	Shock resistance	No abnormality after 150 m/s ² 3 times each in 6 directions.		
	Output indicator	Provided (Color: green)		
	Conducted EMI	Conforms to EN 61204-3 Class A and FCC Class A.		
	Radiated EMI	Conforms to EN 61204-3 Class A.		
	Safety standards	cULus: UL508 (Listing. Class2: Per UL1310), CSA C22.2 No.107.1 (Class2: Per CSA C22.2 No.223) cURus: UL60950-1, CSA C22.2 No.60950-1 EN: EN50178, EN60950-1 VDE: VDE0160, VDE0805 Teil1		
	Weight	2,400 g max.		

- Note**
- (1) Do not use an inverter output for the Power Supply. Inverters with an output frequency of 50/60 Hz are available, but the rise in the internal temperature of the Power Supply may result in ignition or burning.
 - (2) Refer to *Derating Curve* on page xiv for details.
 - (3) If the output voltage adjuster (V. ADJ) is turned, the voltage will increase by more than 10% of the voltage adjustment range. When adjusting the output voltage, confirm the actual output voltage from the Power Supply and be sure that the load is not damaged. If the output voltage exceeds 28.8 V, all branch outputs will be cut off.
 - (4) Rated input and output conditions: Rated input voltage, rated frequency, rated output voltage, rated total output current, and maximum cutoff output current.
 - (5) 100% load conditions: Rated output voltage, rated total output current, and maximum cutoff output current.

External Output and External Tripping Input Specifications

The S8AS has 4 external outputs: the Tripping Alarm Output (TRP), Undervoltage Detection Output (LOW), Maintenance Forecast Monitor Output (LFE), and Over-temperature Output (TMP). It also has an External Tripping Input (TRG).

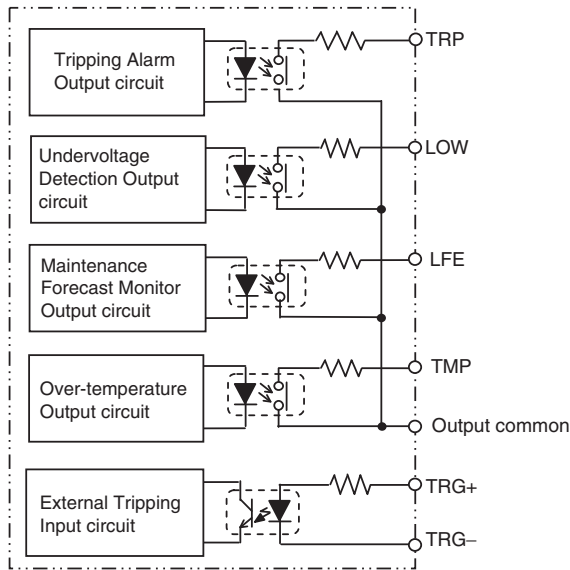

I/O Circuit Configuration

Name	Circuit configuration	I/O specifications
<p>Tripping Alarm Output (TRP), Undervoltage Detection Output (LOW), Maintenance Forecast Monitor Output (LFE) and Over-temperature Output (TMP)</p> <p>Note A photo relay with a photo MOS-FET and infrared diode coupling is used.</p>	<p>Output circuit</p>	<p>30 VDC and 50 mA max.</p>
<p>External Tripping Input (TRG)</p>	<p>Input circuit</p>	<p>19.2 to 30.0 VDC Minimum signal width: 10 ms</p>

Note When a branch output is cut off with the External Tripping Input, it cuts off power to the branch output even faster than turning OFF the S8AS's power supply.

2-4 Basic Function Details

2-4-1 Voltage Monitoring and Protection Functions

Abnormal Voltage Tripping

When the output voltage converted from AC to DC exceeds 28.8 V, all of the branch outputs will be cut off simultaneously and a TRP alarm will be output. The seven-segment display will show error code A10.

It is not necessary for the user to set any parameters for this function.

Tripping operation	Seven-segment display	Outputs	Conditions required to reset
28.8 VDC min. 20 ms max.	Alternately displays error code A10 and the voltage.	The Tripping Alarm Output (TRP) photoswitch output turns OFF.	Voltage below 28.5 V and after tripping (15 s has elapsed after previous reset.)

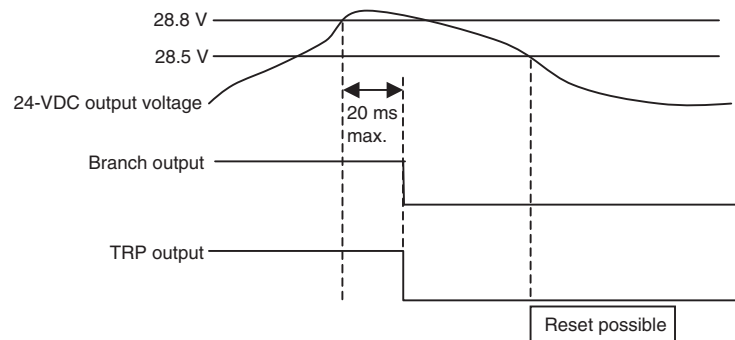

Undervoltage Detection

An undervoltage detection threshold can be set between 18.0 and 26.4 V.

Setting range	Default value	Operation	Seven - segment display	Outputs	Conditions required to reset
18.0 to 26.4 VDC	20.0 V	When the voltage is lower than the detection threshold continuously for 80 ms or more, the alarm is output within 100 ms.	Alternately displays error code A21 and the voltage.	The Undervoltage Detection Output (LOW) photoswitch turns OFF.	Voltage above the detection threshold +0.3 V continuously for at least 500 ms.

Operation

- If the output voltage falls below the detection threshold, the seven-segment display will show the error code A21 and the voltage value, and the Undervoltage Detection Output (LOW) will turn OFF within 100 ms.
- The error display and Alarm Output can be reset when the voltage has been above the detection threshold +0.3 V for 500 ms longer.

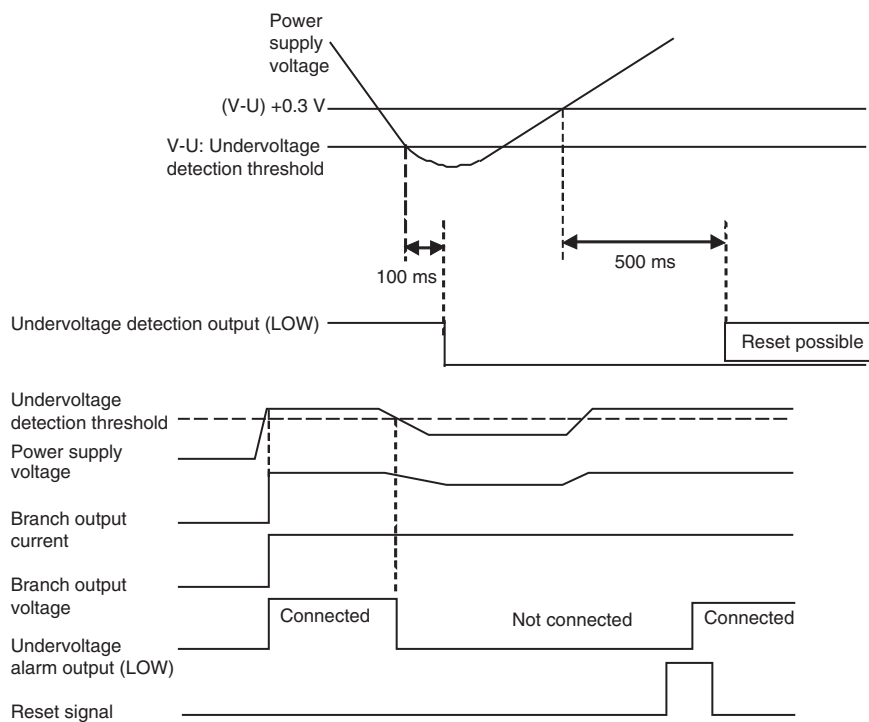

2-4-2 Over-current Protection Functions

Abnormal Current Tripping Function

When an abnormal current is detected, the S8AS cuts off the branch outputs via semiconductor relays.

Each branch output's tripping current can be set between 0.5 and 3.8 A (in 0.1-A increments).

One of the following three detection methods can be selected for each branch in order to detect abnormal currents (except for the S8AS-24006N/48008N, which always use the same detection method.)

- Standard detection (tripping within 100 ms)
- Instantaneous detection (tripping within 20 ms)
- Extended time detection (tripping within 1,000 ms)

Setting range	Default value	Tripping type	Operation	Error code and alarm output	Conditions required to reset
0.5 to 3.8 A	3.8 A	Standard	When a current higher than the set value is detected, the branch output is cut off within 100 ms.	The error code A11 and current are displayed alternately on the seven-segment display and the Tripping Alarm Output (TRP) photoswitch output turns OFF.	After tripping (15 s has elapsed after the previous reset.)
		Instantaneous	When a current higher than the set value is detected, the branch output is cut off within 20 ms.		
		Extended time	When a current higher than the set value is detected, the branch output is cut off within 1,000 ms.		

When the abnormal current is detected and branch output is cut off, the error code (A11) and present current are displayed alternately on the seven-segment display and the Tripping Alarm Output (TRP) is turned OFF.

The status indicator of the branch output that was cut off will flash red.

To clear the error, eliminate the cause of the error, and then press the Reset Key. Once an error has been reset, another reset operation cannot be performed for at least 15 seconds.

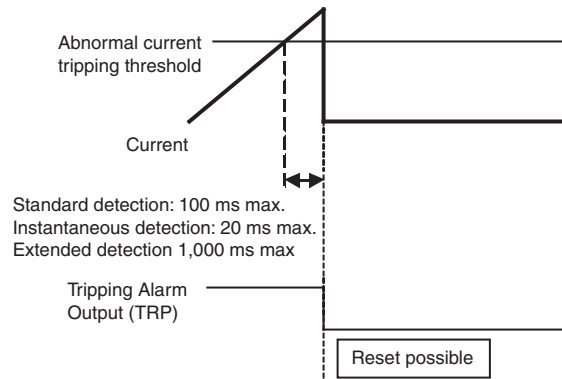

Current Tripping Characteristics

■ Standard Detection

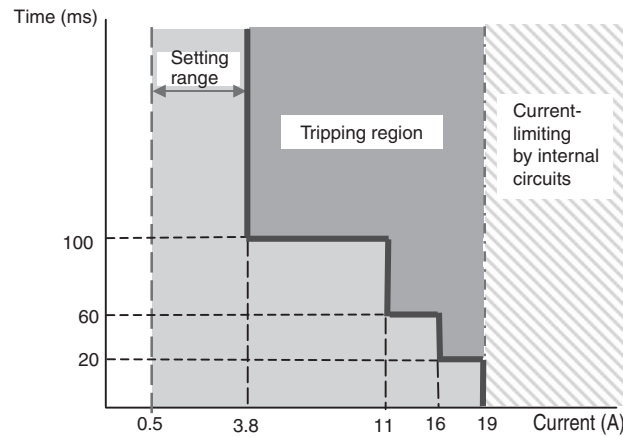

Tolerance of current tripping alarm threshold: ± 0.3 A. When the tripping current (0.5 to 3.8 A) is detected, it is cut off within 100 ms.

■ Instantaneous Detection

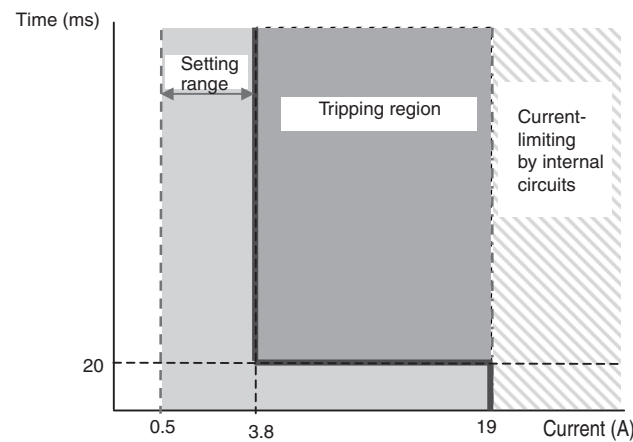

Tolerance of current tripping alarm threshold: ± 0.3 A. When the tripping current (0.5 to 3.8 A) is detected, it is cut off within 20 ms.

■ Extended Detection

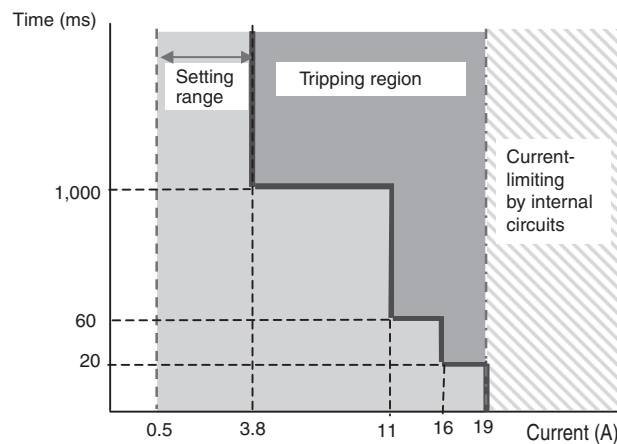

Tolerance of current tripping alarm threshold: ± 0.3 A. When the tripping current (0.5 to 3.8 A) is detected, it is cut off within 1,000 ms.

Note The S8AS contains a current-restricting circuit that prevents a current above a specific value from flowing. The current is thus restricted during the time required to cut off the output.

Note After sampling and converting each branch output's current every 1 ms, the S8AS processes the values in the CPU and controls the branch output cut-offs. This method achieves high-speed, high-accuracy tripping. In addition, to minimize the effects of excessive currents caused by short-circuits, the S8AS is equipped with built-in current-limiting circuits. Consequently, there is a

region in which the current is limited, as shown in the current tripping characteristics graphs.

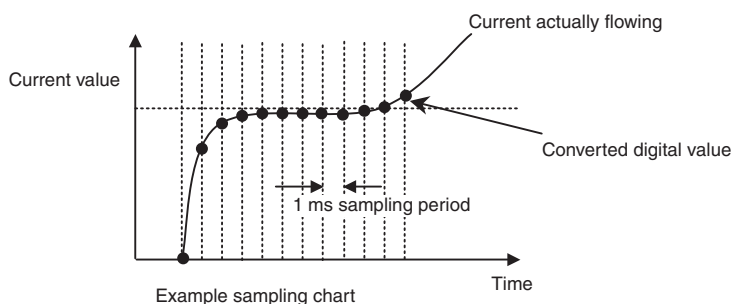

Abnormal Total Current Tripping Function

The S8AS monitors the total output current as well as the branch output currents. When the total output current exceeds the set value, all branch outputs will be cut off. There are a number of conditions for the tripping current and time. If even one of these conditions is detected, the abnormal total current tripping function will be activated. The following table outlines the tripping conditions. (Input voltage range: 200 to 240 VAC)

Power-ON time (s)	Total current (A)		Operation	Error code and alarm output	Conditions required to reset
	240W	480W			
1 s min.	---	27 A	When the total current reaches these values, all branches will be cut off within 20 ms.	The error code A12 will flash on the seven-segment display and the Tripping Alarm Output (TRP) photoswitch output will turn OFF.	After tripping (15 s has elapsed after the previous reset.)
2 s min.	17 A	25 A			
5 s min.	15 A	22.5 A			
10 s min.	13 A	—			
20 s min.	12 A	—			

—: Not applicable

- Note**
- (1) If the input voltage range is not within the values specified above or the total output current exceeds the maximum peak current value, internal operation will become unstable and the branch outputs may be cut off.
 - (2) Maintain the total current for normal operation after the load devices have started to within the rated ranges.
 - (3) Do not allow a peak current to flow again for at least 60 seconds after a peak current has exceeded the rated current.

Startup Delay

Normally, a large inrush current may run through the system when equipment starts. Tripping operation can be disabled for a short time after the semiconductor relay goes ON in order to prevent this inrush current from being detected as an abnormal current and cutting off operation. This temporary disabling of the tripping function is called the startup delay.

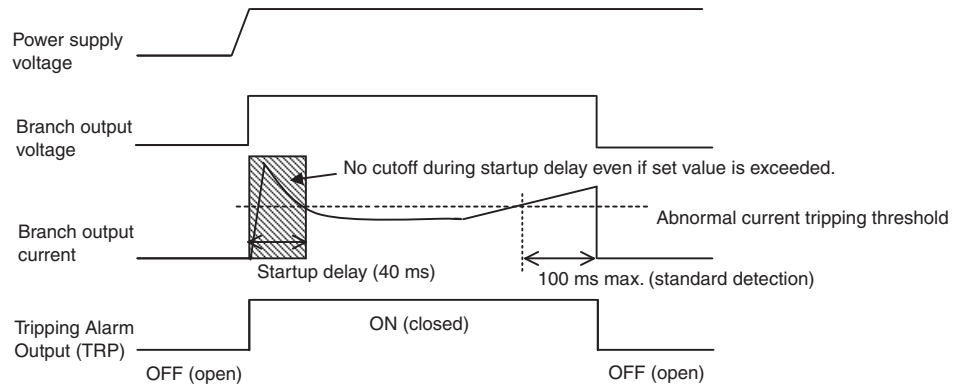

Note The startup delay disables the tripping operation for the specified period of time. The inrush current during this time can be displayed as the peak output current. The S8AS, however, contains a current-restricting circuit, so the peak value is not necessarily an accurate measure of the peak inrush current of the connected device.

Safety Functions

Short-circuit Protection Fuse

If an error occurs that prevents the semiconductor relay from cutting off a branch output, the short-circuit protection fuse will blow to protect the circuit.

Note If the fuse blows, that branch output cannot be used.

Thermal Fuse

If an error occurs that prevents the semiconductor relay from cutting off a branch output and the temperature of the S8AS's internal resistors rises abnormally high, the S8AS's thermal fuse will blow to prevent a fire hazard.

Note If the fuse blows, that branch circuit cannot be used.

2-4-3 Maintenance Forecast Monitor Function

The maintenance forecast monitor function calculates the replacement time from the power-ON time and internal temperature. The maintenance forecast monitor output (LFE) will operate when the calculated value reaches the set value. (The set value is fixed at 0.5 years for the S8AS-24006N/48008N and cannot be changed.) When the maintenance forecast monitor output (LFE) is turned ON, the error code A23 and the estimated replacement time are displayed alternately on the seven-segment display.

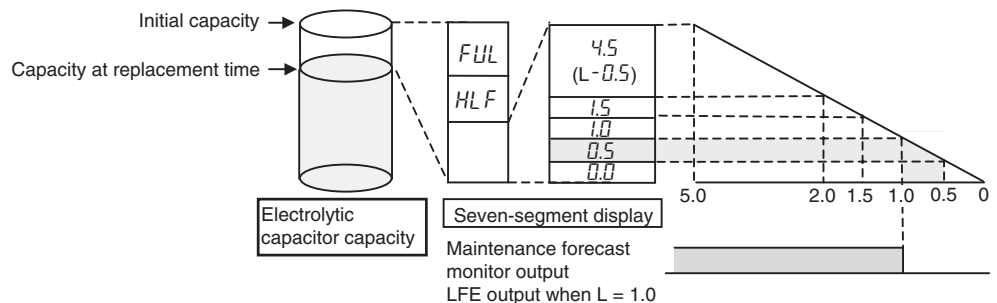

When the life of the electrolytic capacitor (expected value = 10 yr) has halved, the remaining life span (5 yr) is divided into 10 levels (in 0.5-yr increments). These levels are used by the maintenance forecast monitor output (LFE) to display the number of years that are left before the Power Supply needs to be replaced.

Note The expected life span of the S8AS is 10 years, but it will change depending on the amount of time it is in operation and the ambient temperature.

2-4-4 Over-temperature Output

When the temperature exceeds the set value continuously for more than 1 s, the seven-segment display will show error code A30 and the Over-temperature Output (TMP) will go OFF.

The error display and Over-temperature Output are reset automatically when the temperature has been below the set value minus 3°C for more than 5 s.

Setting range	Default value	Operation	Seven-segment display	Outputs	Conditions required to reset
25 to 90°C	90°C	The output is turned OFF when the temperature higher than the set value continuously for more than 1 s.	Alternately displays error code A30 and the temperature(°C).	The Over-temperature Output (TMP) photo-switch output turns OFF.	Reset automatically when the temperature falls below the set value minus 3°C.

Over-temperature Output (TMP)

When the temperature falls below the set value minus 3°C, the over-temperature output automatically turns ON.

- The over-temperature output (TMP) can be used to start an exhaust fan or air conditioner to reduce the temperature in the control panel.
- The initial value is set at 90°C so that the over-temperature output is essentially disabled at the beginning.

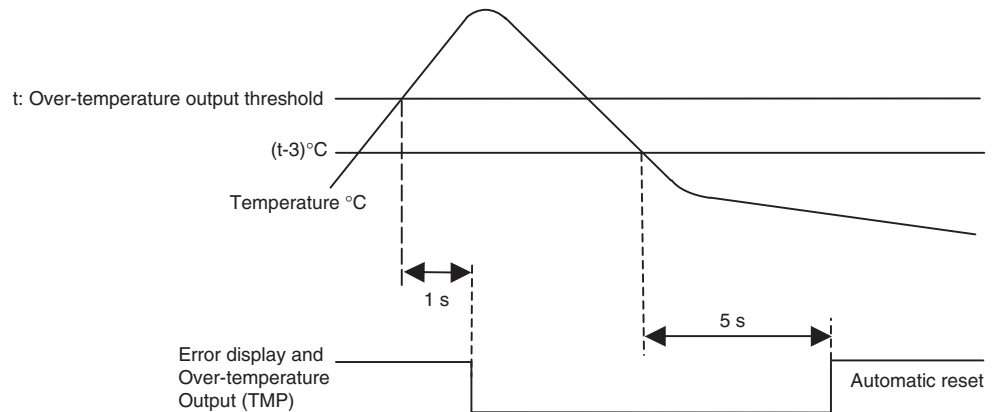

Example Application

The output is normally closed (ON) and goes OFF when there is an error, so receive the TMP output through an auxiliary relay. In addition, the output will go ON momentarily when the power is turned ON, so receive the output through a time-delay relay. (For details, refer to page 50.)

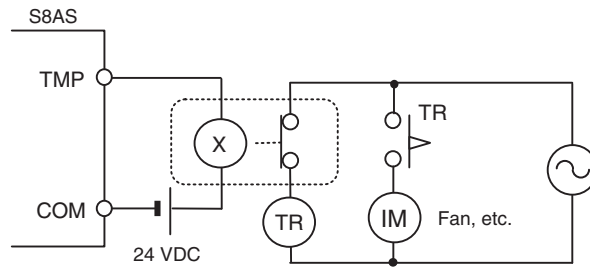

Relationship between Control Panel Temperature and S8AS Internal Temperature

The internal temperature of the S8AS is displayed. This is not necessarily the same as the ambient temperature of the S8AS or the temperature inside the control panel. The difference between the internal temperature of the S8AS and the ambient temperature depends on the current flowing through the S8AS. Consider this difference in the application.

The following graph provides reference information on the displayed internal temperature and the ambient temperature.

Conditions: The same current was output from all branch outputs in a constant-temperature bath held at a constant temperature

■ 240 W

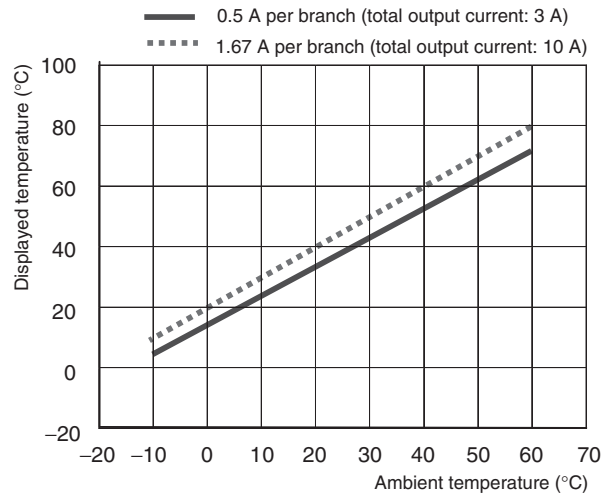

■ 480 W

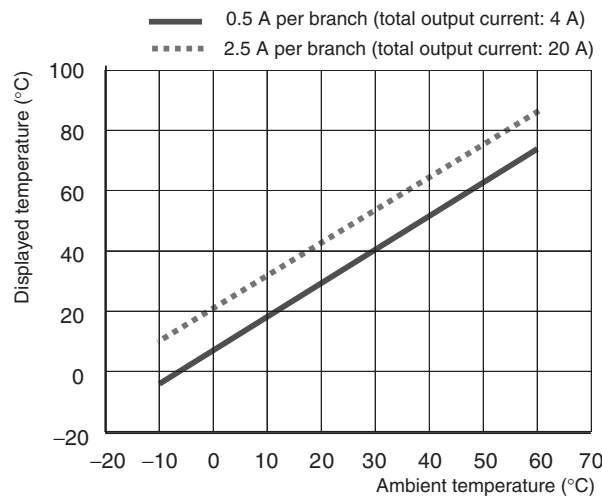

2-5 Startup Sequence Function

The inrush current may cause a voltage drop if all of the branch outputs are connected simultaneously and there is little spare capacity in the power supply or the loads connected to the branch outputs are capacitive loads. A significant voltage drop may cause an output to be cut off. In this case, a time delay can be applied between the connections of the branch outputs to minimize the voltage drop.

- Note**
- (1) The time delay can be set between 0.0 and 99.9 s. (If the delay is set to 0.0 s, the startup sequence will not operate and the branch output will be connected immediately.)
 - (2) The startup sequence is designed for the four branch outputs on one S8AS. It does not provide time synchronization between outputs on more than one S8AS.

After the power supply is turned ON and the self-diagnostics are performed, the S8AS will start connecting the branch output according to their preset startup sequence times.

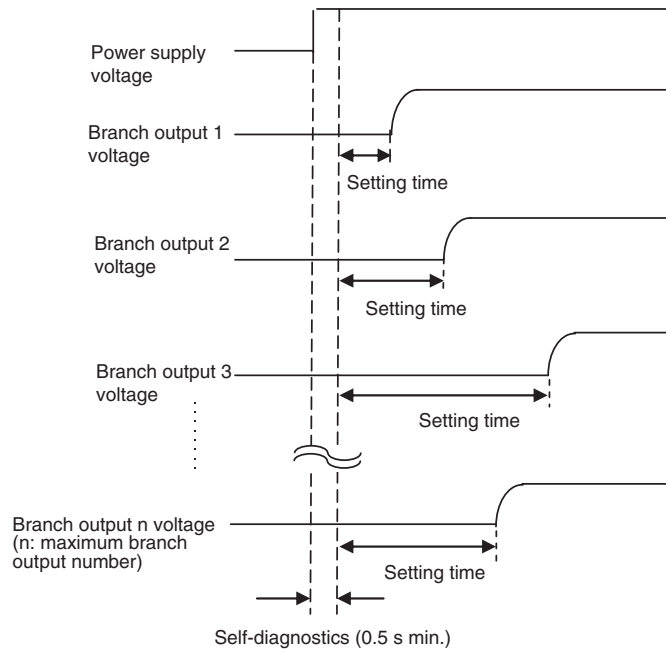

- The branch output's status indicator will flash green during the startup sequence time until it is connected.
- The startup sequence's operation can be verified in Test Mode. For details, refer to 5-3 *Checking Sequence Operation*.
- The startup sequence for models with unchangeable settings (S8AS-24006N/48008N) cannot be changed.

Branch output number	1	2	3	4	5	6	7	8
Setting time	0.0 s	0.4 s	0.8 s	1.2 s	1.6 s	2.0 s	2.4 s	2.8 s

Note The startup sequence functions in the following processes:

- Connecting when power is turned ON
- Reconnecting during a reset operation
- Simultaneous connection of all outputs in Test Mode

2-6 Shutdown Sequence Function

When the S8AS's input power supply is turned OFF, all of the branch outputs are turned OFF (disconnected) simultaneously. On the other hand, when the branch outputs are cut off by the external tripping input or communications, a time delay can be applied between the branch output disconnections.

- Note**
- (1) The time delay can be set between 0.0 and 99.9 s. (If the delay is set to 0.0 s, the startup sequence will not operate and the branch output will be cut off immediately.)
 - (2) The shutdown sequence is designed for the four branch outputs on one S8AS. It does not provide time synchronization between outputs on more than one S8AS.

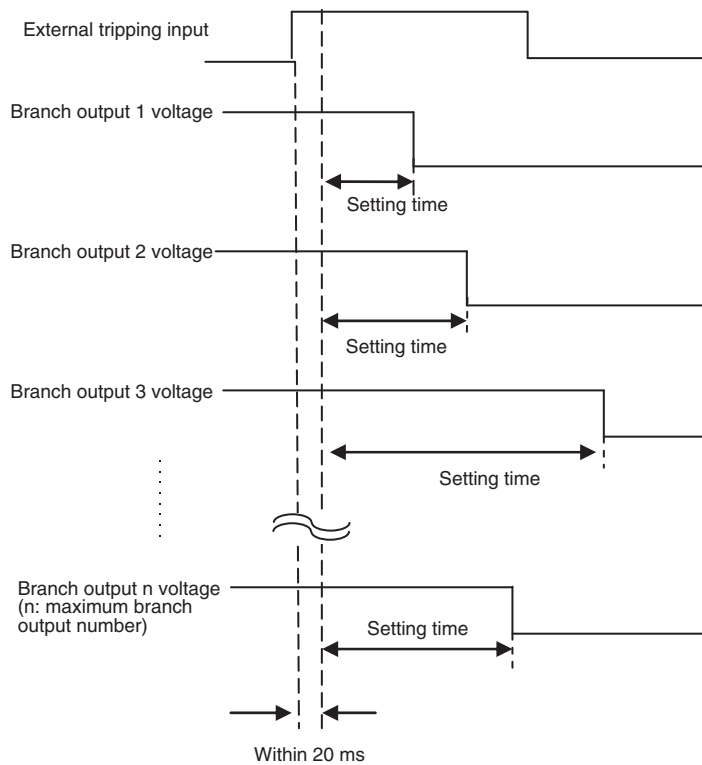

- (3) When operation is cut off due to an abnormal voltage (above 28.8 V), all of the branch outputs will be cut off simultaneously.
- (4) The shutdown sequence function will operate on a branch output only if the external tripping input is enabled for that branch output. For details, refer to *Tripping Input Trigger Setting: TRG (Trigger)* on page 68.
- (5) The shutdown sequence setting times for all branch outputs for the S8AS-24006N/48008N are set to 0.0 s and cannot be changed.
 - The shutdown sequence's operation can be verified in Test Mode. For details, refer to *5-3 Checking Sequence Operation*.

Note The shutdown sequence functions in the following processes:

- Cutoff processing for the external tripping input
- Simultaneous cutoff of all outputs in Test Mode

2-7 External Tripping Input Function

The external tripping input (TRG) can be used to cut off or reconnect branch outputs using an external input signal. The following settings are required to use this function.

Item	Function	Settings
External tripping input activation	Enables the external tripping input (TRG) function for each branch.	ON (enabled) OFF (disabled)
Tripping trigger type	Sets the external tripping input trigger signal type.	EGE (edge trigger) LVL (level trigger)

The external tripping input is enabled and tripping type for the S8AS-24006N/48008N is set to EGE and these settings cannot be changed.

Tripping Trigger Type: Edge Trigger (EGE)

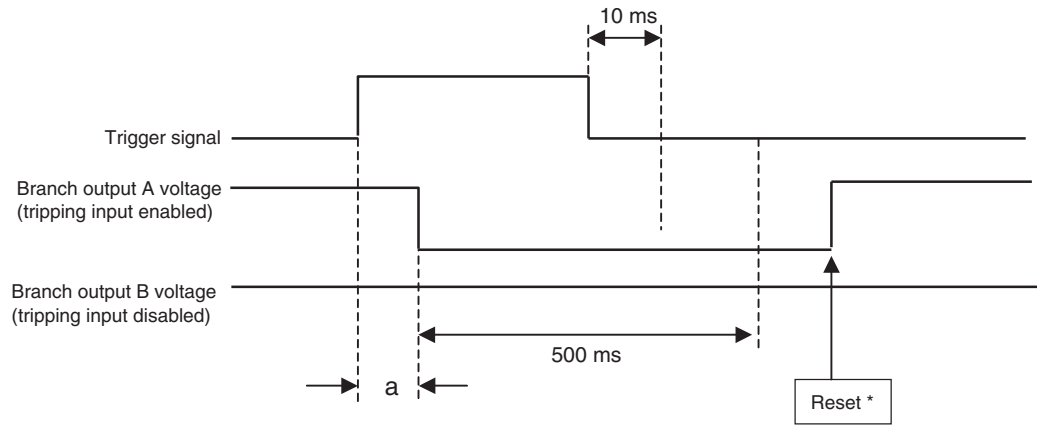

a: 20 ms + Shutdown sequence setting time

*: Connected after startup sequence setting time has elapsed.

If the trigger signal (TRG) stays OFF for more than 10 ms and the branch output is disconnected for more than 500 ms, the reset input can be received.

Tripping Trigger Type: Level Trigger (LVL)

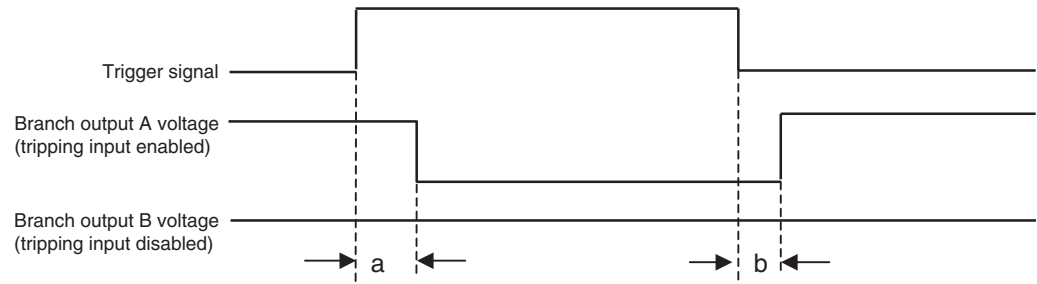

a: 20 ms + Shutdown sequence setting time

b: 20 ms + Startup sequence setting time

SECTION 3

Installation and Wiring

This section describes how to install and wire the S8AS.

3-1	Installing the S8AS	42
3-2	Installation	44
3-3	Power Supply and Input/Output Wiring	47
3-4	RS-485 Port Wiring	52

3-1 Installing the S8AS

Installation and Wiring Precautions

Installation Site

To increase the S8AS system's reliability and take full advantage of the S8AS's functions, observe the following precautions when installing the S8AS.

Avoid locations with any of the following conditions when installing the S8AS.

- Locations subject to a temperature below -10°C or over 60°C
- Locations subject to a humidity below 25% or over 85% (no condensation/icing)
- Locations subject to direct sunlight
- Locations subject to exposure to liquids, debris, or corrosive gases
- Locations subject to severe shock or vibration
- Locations near equipment that generates strong high-frequency noise or surges

Always enclose or protect the S8AS sufficiently in the following locations.

- Locations subject to static electricity or other forms of noise.
- Locations subject to strong electromagnetic fields.
- Locations subject to possible exposure to radioactivity.
- Locations close to power lines.

Installation in Cabinets or Control Panels

When the S8AS is being installed in a cabinet or control panel, always provide suitable ambient conditions as well as access for operation and maintenance.

Ambient Temperature

The operating temperature range for the S8AS is -10°C to 60°C . Observe the following precautions.

- Provide enough space for good air flow.
- Do not install the S8AS above equipment that generates a large amount of heat, such as heaters, transformers, or high-capacity resistors.
- If the ambient temperature in the cabinet may exceed 60°C , install an exhaust fan or air conditioner and use the Over-temperature Output to operate the cooling equipment.

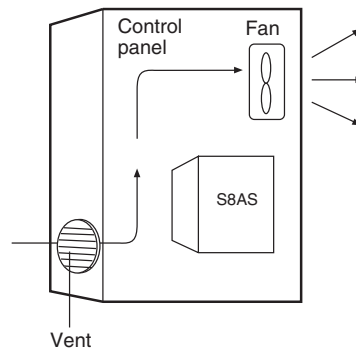

- Mount the S8AS at least 20 mm away from heat sources.
- Leave at least 75 mm between the S8AS and other devices above and below it.

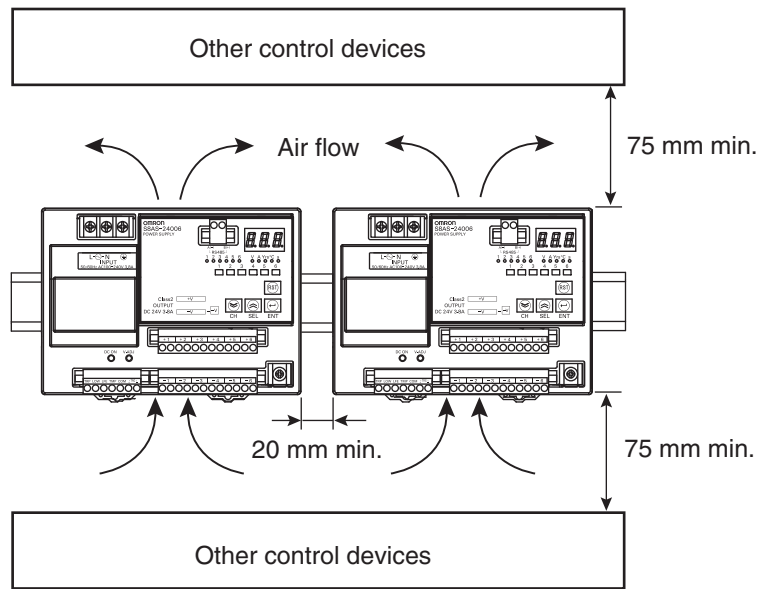

3-2 Installation

When mounting the S8AS in a panel, use DIN Rail. Surface installation cannot be used.

Mounting in a Panel

- The S8AS must be installed in the orientation shown below to ensure adequate cooling.

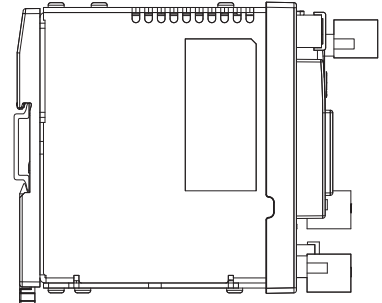
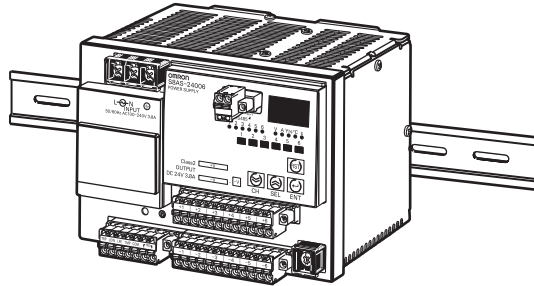

- Do not install the S8AS in any of the following orientations.

Incorrect

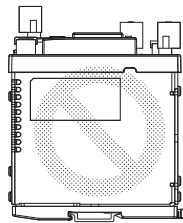

Incorrect

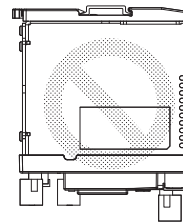

Incorrect

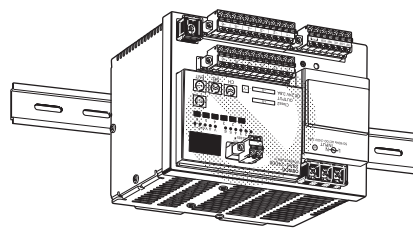

Incorrect

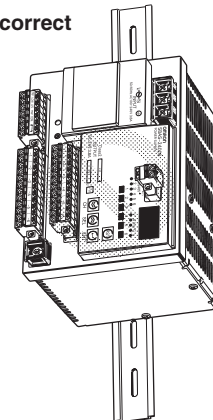

External Dimensions

S8AS-24006 (240-W Model with 6 Branch Outputs)

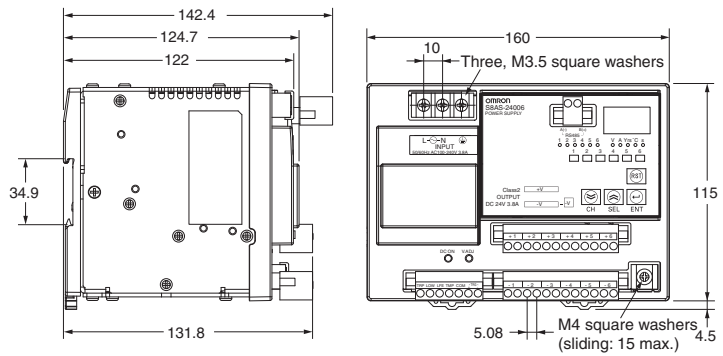

S8AS-48008 (480-W Model with 8 Branch Outputs)

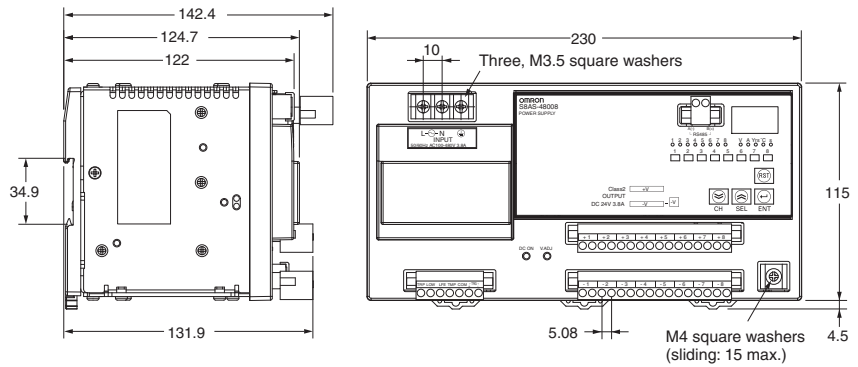

Attachment to the DIN Rail

The S8AS attaches to the DIN Rail with one snap. Hang the S8AS on the top of the DIN Rail with the installation notch on the back of the S8AS, pivot the S8AS downward, and press until the S8AS locks securely on the Rail.

1,2,3...

1. Pull out the two lock levers on the S8AS. Lower the S8AS so that the installation notch hooks onto the top of the DIN Rail.

2. Hook the installation notch on the top of the DIN Rail.

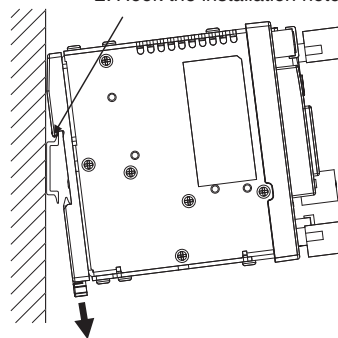

1. Pull out the lock levers.

2. Press the S8AS onto the DIN Rail and push in the lock levers. Press the lock levers until the locks engage securely.

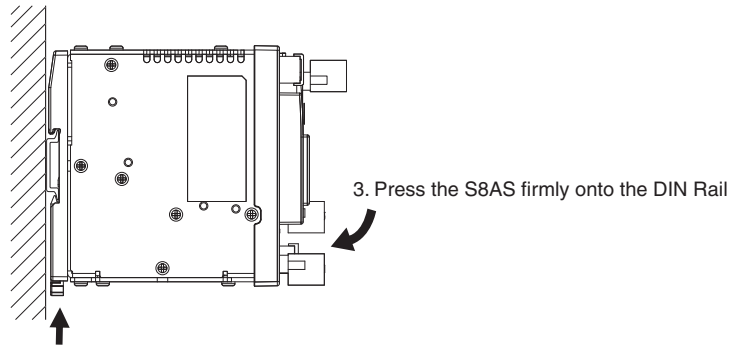

4. Press in the lock levers until the locks engage securely.

After the S8AS is mounted on the DIN Rail, attach an End Plate on each side of the Power Supply to secure it in place.

■ Recommended End Plate

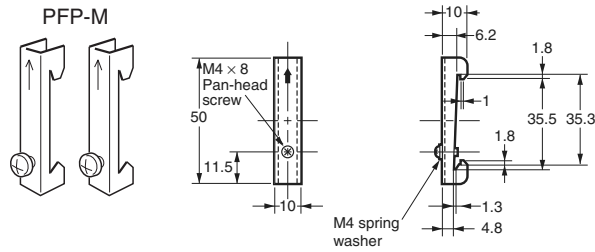

Removal

When removing the S8AS from the DIN Rail, pull the lock lever down with a flat-blade screwdriver and pivot the S8AS upward to remove it.

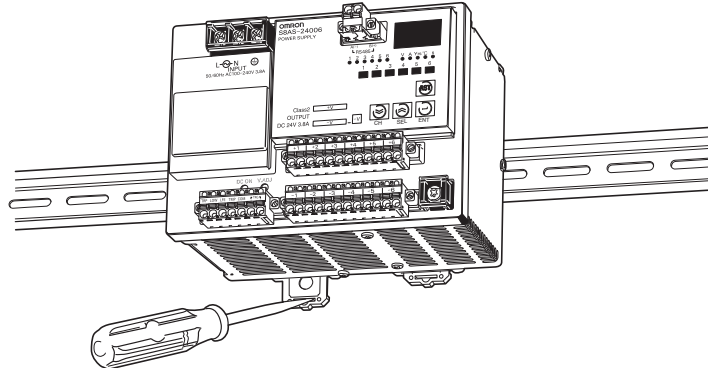

3-3 Power Supply and Input/Output Wiring

Wiring Precautions

- When wiring, cover the top of the S8AS to prevent wire strands from entering. After completing the wiring, be sure to remove the cover to avoid overheating.
- Use the following crimp terminals on the power input wires and tighten the terminal screws to the specified torque.



AC input terminals and protective earth (PE) terminals: M3.5

Negative branch output terminals: M4

Selecting the Wire

Terminals	Name	Recommended wire diameter	Wire type	Torque	Wire stripping length
Screw terminals	AC input terminals and protective earth (PE) terminal	AWG14 to AWG16 (Cross-section area: 1.309 to 2.081 mm ²)	Solid or stranded	1.08 N·m (9.6 in lb)	8 to 10 mm
	Branch output terminals (-), UL Standard	AWG12 to AWG14 (Cross-section area: 2.081 to 3.309 mm ²)	Solid or stranded	1.2 N·m (10.6 in lb)	8 to 10 mm
	Branch output terminals (-), CSA Standard	AWG12 to AWG20 (Cross-section area: 0.517 to 3.309 mm ²)	Solid or stranded	1.0 N·m (8.8 in lb)	8 to 10 mm
Screwless terminals	Positive branch output terminals, negative branch output terminals, I/O signal terminals, and communications terminals	AWG12 to AWG24 (Cross-section area: 0.2 to 2.5 mm ²)	Solid or stranded	---	10 mm

Refer to the following table when selecting wire to use for the power supply.

AWG	Cross-sectional area (mm ²)	Configuration (wires/mm)	Voltage drop per A (mV/m)	Max. recommended current (A)	
				UL1007 (300 V 80°C)	UL1015 (600 V 105°C)
30	0.051	7/0.102	358	0.12	---
28	0.081	7/0.127	222	0.15	0.2
26	0.129	7/0.16	140	0.35	0.5
24	0.205	11/0.16	88.9	0.7	1.0
22	0.326	17/0.16	57.5	1.4	2.0
20	0.517	26/0.16	37.6	2.8	4.0
18	0.823	43/0.16	22.8	4.2	6.0
16	1.309	54/0.18	14.9	5.6	8.0
14	2.081	41/0.26	9.5	---	12.0
12	3.309	65/0.26	6.0	---	22.0
10	5.262	104/0.26	3.8	---	35.0

Maximum Recommended Current:

The values listed in the table above are for bundles of up to 4 wires. If 5 or more wires are bundled together, reduce the max. current to 80% of the listed current.

The following chart shows only the relationship between the voltage drop per meter and the current and wire length. Be sure that the current actually being used does not exceed the max. recommended current.

**Voltage Drop per Meter
(UL1015 Heat-resistant
PVC Wire)**

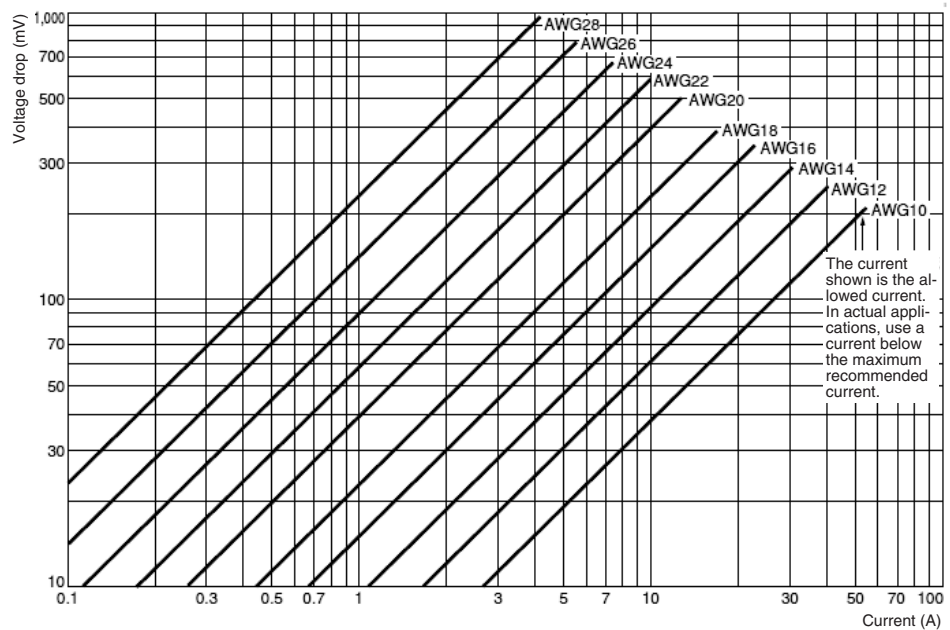

**Wiring the AC Input
and Protective Earth
(PE) Terminals**

- Use 100 to 240 VAC (85 to 264 VAC) 50/60 Hz power supply with minimal voltage fluctuation. Use wires with a high current carrying capacities.
- Be sure to connect the protective earth (PE) terminal to ground to prevent electric shock and malfunction.

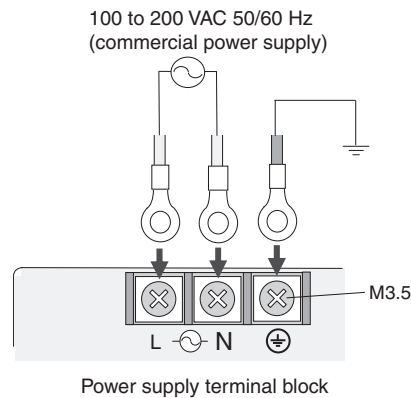

**Wiring the Branch
Outputs**

Two positive and two negative terminals are used for each branch output.

■ Wiring the Branch Output Connector
240 W

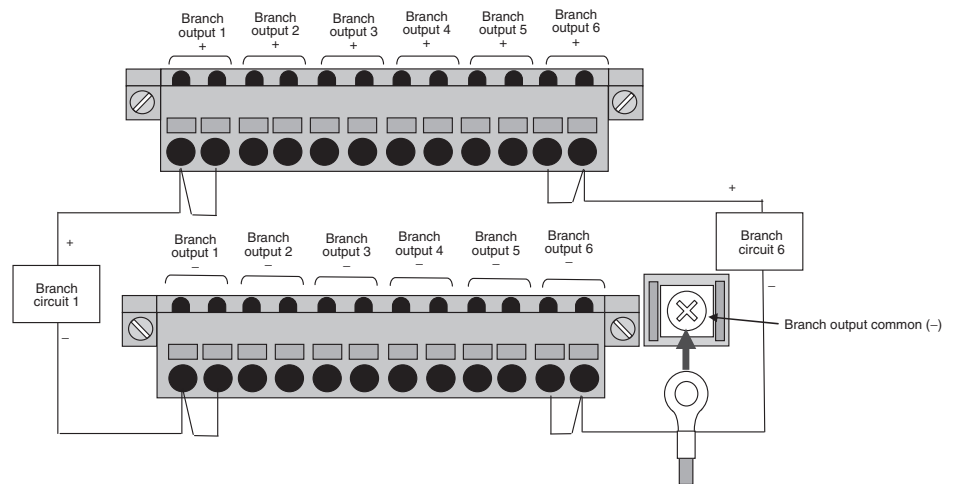

480 W

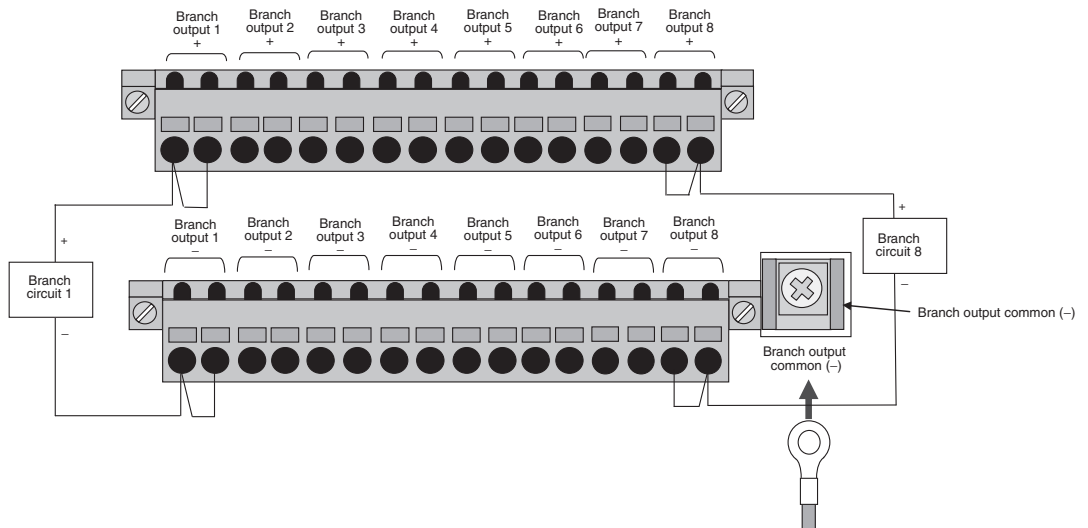

Note You may connect the positive terminals or the negative terminals of the same branch output in parallel, but do not connect them with other branch outputs. The lock screws on both sides of the branch output connector are loose when shipped from the factory. Tighten them securely after you complete the wiring.

Wiring the Terminal Block Connectors

Use a solid or stranded wire. If you are using stranded wire, twist the end before connecting it to make a clean connection.

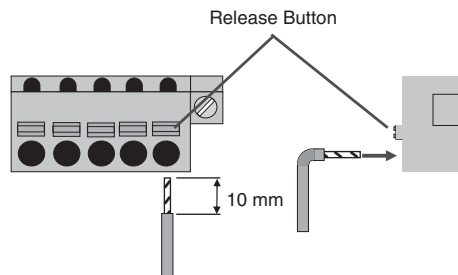

- Strip the wire for approximately 10 mm from the end.
- Insert a flat-blade screwdriver into the release button to release the lock. Insert the wire into the round hole, and then release the button to lock the wire in place.

- When inserting the wire, make sure that the stripped portion of the wire is fully inserted and not left exposed.
- After completing a connection, lightly pull on the wire to make sure that it has been locked in properly.

Wiring the External Outputs and External Tripping Input

The TRP, LOW, LFE, and TMP outputs operate as normally closed outputs, which are OFF when the power is OFF, ON during normal operation, and OFF when an error has occurred. If you want to use these an external output as a normally open output, invert the signal through an auxiliary relay (X). When doing so, the alarm may turn ON momentarily when the power supply is turned ON. To prevent this, delay the signal through the delay relay (TR).

The branch output is cut off when the External Tripping Input (TRG) is ON (connected).

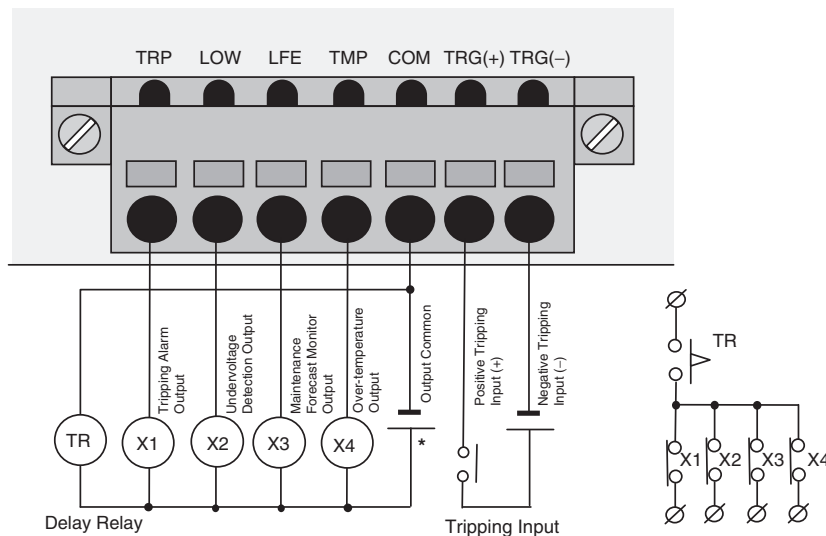

* Output terminals do not have polarity.

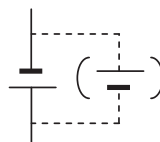

No.	Name		Function
1	TRP	Tripping Alarm Output	The photoswitch output turns OFF when the branch output is cut off due to an abnormal voltage or abnormal current.
2	LOW	Undervoltage Detection Output	The photoswitch output turns OFF when the output voltage drops below the set value.
3	LFE	Maintenance Forecast Monitor Output	The photoswitch output turns OFF when the estimated replacement time drops below the set value.
4	TMP	Over-temperature Output	The photoswitch output turns OFF when the S8AS's internal temperature exceeds the over-temperature output threshold.
5	COM	Output Common	Common terminal for the four outputs described above.
6	TRG (+)	External Tripping Input	Branch outputs can be cut off from an external operation. (The shutdown sequence is applied in this case.)
7	TRG (-)		

■ Internal Circuits

Output circuits	30 VDC, 50 mA max., photoswitch output
Input circuit	19.2 to 30.0 VDC Minimum signal width: 10 ms

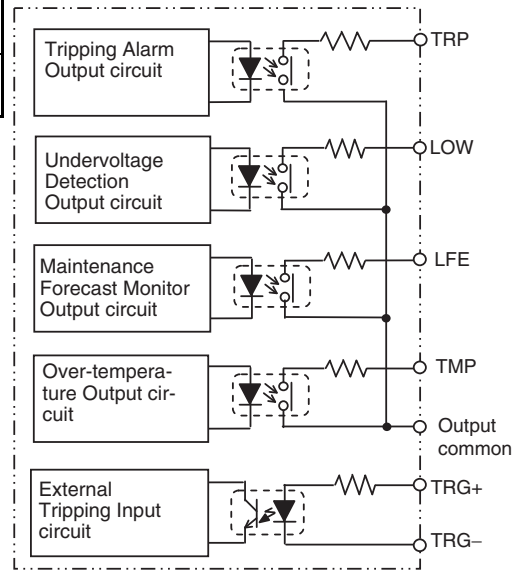

3-4 RS-485 Port Wiring

Wiring the RS-485 Port

S8AS models with communications have an RS-485 port that can be connected with a host computer or controller.

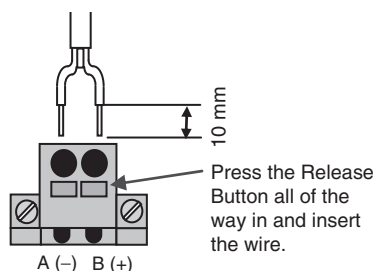

- Strip 10 mm from the ends of the RS-485 cable's wires.
- Press the terminal's release button all the way in and insert the wire into the round wire hole. When the wire is inserted, be sure that the wire conductor is not exposed.
- Release the release button to lock the wire in place.
- After wiring, verify that the wires are securely locked in the terminals.

Example Connection to a Host Computer

- The connection format is 1:1 or 1:N. Up to 32 nodes can be connected to a host computer.
- Insert a Cramp Filter (E04SR301334 manufactured by SEIWA) in the cable as a countermeasure against noise.

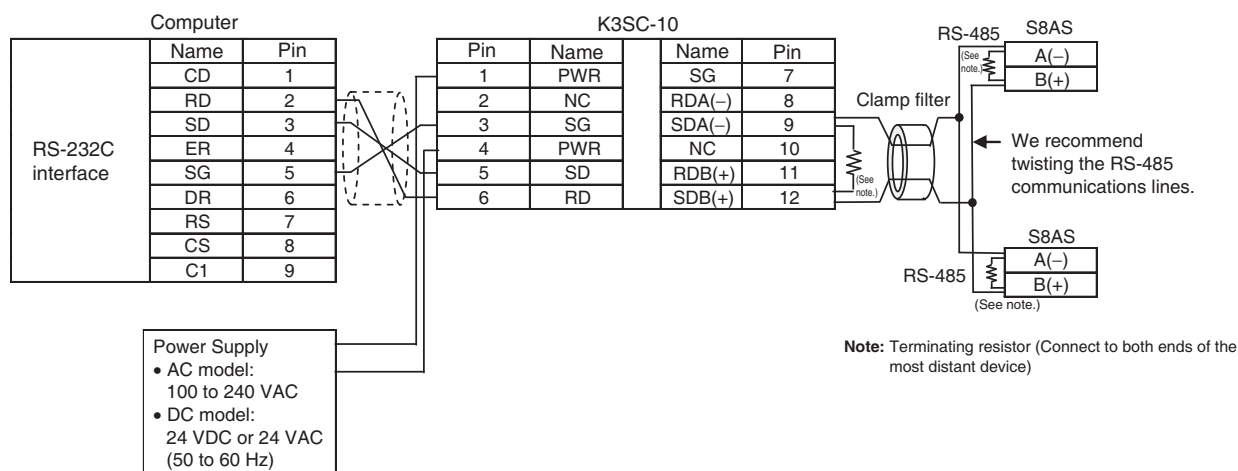

- A terminating resistor must be connected to the most distant device of the transmission path, including the host computer. Use a terminating resistor with a resistance of 120 Ω (1/2W).
- Make sure that the communications specifications are set to the same values for the host computer and the S8AS. (Refer to 4-1 Parameter Table.) When connecting in a 1:N format, make sure that the communications specifications except for the communications unit number are set to the same values for all nodes. A unique communications unit number must be set for each node.

SECTION 4

Parameter Settings

This section explains how to set S8AS parameters.

4-1	Parameter Table	54
4-2	Switching the Operating Mode	56
4-3	Changing the Protection Level	59
4-4	Switching to Setting Mode	60
4-5	Individual Branch Output Settings	61
4-6	Shared Parameter Settings	63
4-7	Special Settings and Communications Settings	66

4-1 Parameter Table

The S8AS's operation is determined by the parameter settings. Each parameter is set to its default value, but each parameter should be checked and set as required to adjust the S8AS for use in the system.

Parameters cannot be changed for the S8AS-24006N/48008N. Always use the default values.

Parameter		LED Indicators			Setting range	Default value	Access in each protection level (See note 3.)		
		Seven-segment display	Unit indicator	Branch output indicator			2	1	0
Branch output 1	Current tripping threshold	[-u]	A	Lit	0.5 to 3.8 A	3.8 A	Δ	○	○
	Current tripping type	[-t]	A	Lit	USU: Standard INS: Instantaneous LNG: Extended	Standard Extended (See note 4.)	×	×	○
Branch output 2 to 8	Same as branch output 1								
Undervoltage detection threshold		u-U	V	---	18.0 to 26.4 V	20.0 V	Δ	○	○
Maintenance forecast monitor output		LFE	Yrs	---	0.0 to 5.0 yr	0.5 yr	Δ	○	○
Over-temperature output threshold		t-nP	°C	---	25 to 90°C	90°C	Δ	○	○
Startup sequence	Individual branch output settings	UPS	s	Lit	0 to 99.9 s	0 s (See note 1.)	×	×	○
Shutdown sequence	Individual branch output settings	dYS	s	Lit	0 to 99.9 s	0 s	×	×	○
Tripping trigger input setting	Individual branch output settings	t-rG	---	Lit	OFF ON	ON	×	×	○
Tripping trigger type setting		tGS	---	---	EGE: Output cut off when status changes from OFF to ON LVL: Output cut off when status changes from OFF to ON, or ON to OFF	EGE	×	×	○
Communications settings (See note 2.)	Unit number	Unā	---	---	0 to 31	1	×	×	○
	Baud rate	dPS	---	---	48: 4,800 bps 96: 9,600 bps	9,600 bps			
	Data length	LEn	---	---	7: 7 bits 8: 8 bits	7			
	Stop bits	b-t	---	---	1: 1 bit 2: 2 bits	2 bits			
	Parity	PtY	---	---	NON: None EVEN: Even ODD: Odd	EVN			
	Send wait time	Syt	---	---	0 to 999 ms	0 ms			
Reset input settings		rSE	---	---	KEY: RST Key only ALL: RST Key or reset power supply	All	×	×	○

×: No access (The parameter cannot be set or displayed.)

Δ: Read-only access

○: Full access (The parameter can be set or displayed.)

Note

- (1) Parameters cannot be changed for the S8AS-24006N/48008N. Use the default settings. For details, refer to *2-5 Startup Sequence Function*.
- (2) The communications settings can be changed for the S8AS-24006R/48008R only. Changes to the parameters are valid after the power has been turned OFF and ON again.
- (3) For information changing the protection level, refer to *4-3 Changing the Protection Level*.
- (4) The default setting for the S8AS-24006N/48008N is for an extended setting.

4-2 Switching the Operating Mode

The following diagram illustrates mode transitions for the S8AS.
The S8AS's parameters are set in Setting Mode

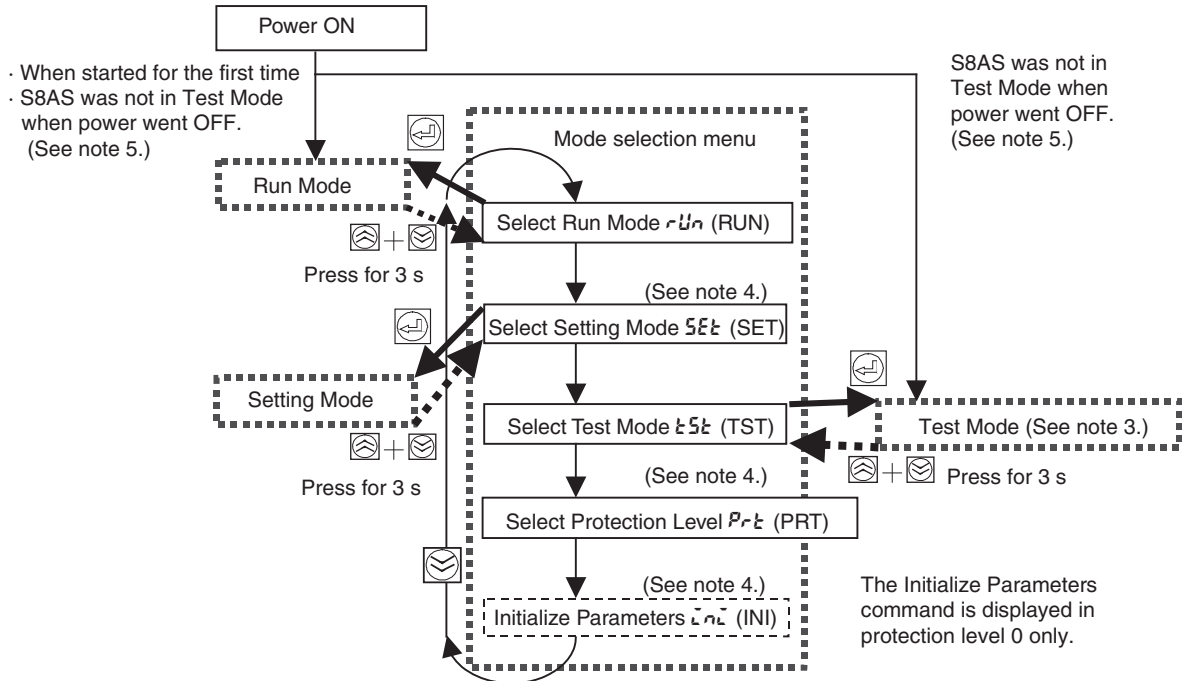

- Note**
- (1) One of three protection levels can be set to restrict parameter read/write access. Parameters cannot be changed for the S8AS-24006N/48008N. For details, refer to 4-3 Changing the Protection Level.
 - (2) Parameter initialization sets all S8AS parameters to their default values. Parameters cannot be changed for the S8AS-24006N/48008N. For details, refer to 4-1 Parameter Table.
 - (3) Test Mode can be entered only in protection level 0 or 1.
 - (4) The Setting Mode, Protection Level, and Parameter Initialization displays cannot be accessed with models that do not permit changes in parameter settings (S8AS-24006N/48008N).
 - (5) If the Mode Selection Menu is entered from Test Mode and then the power is turned OFF before entering another operating mode, the S8AS will start in Test Mode the next time it is started.

Starting for the First Time When the S8AS is started for the first time, it will enter Run Mode. The default protection level is level 1, so the Parameter Initialization Display (INI) cannot be entered without changing the protection level.

Starting for Normal Operation When the S8AS is started, it will enter Run Mode. If the power was turned OFF while the S8AS was in Test Mode, it will start in Test Mode the next time it is started.

The Protection Level or Parameter Initialization Display can be selected from the Mode Selection Menu. These options will not be displayed for the S8AS-24006N/48008N.

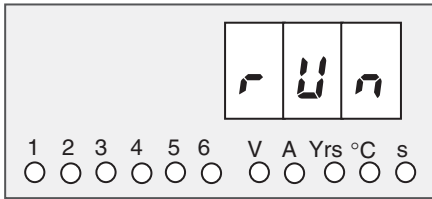

Switching to the Mode Selection Menu Press both the Up (SEL) Key (⏮) and Down (CH) Key (⏭) simultaneously for 3 seconds to display the Mode Selection Menu.

Switching between Displays in the Mode Selection Menu

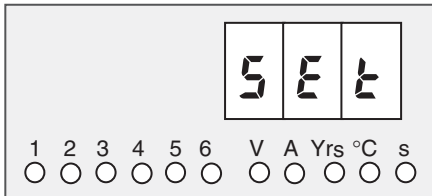

When the S8AS is switched to the Mode Selection Menu from Run Mode, the seven-segment display will show "RUN."





If the  Key is pressed, SET will be displayed. If the  Key is pressed at this point, the S8AS will enter Setting Mode.

Refer to 4-4 *Switching to Setting Mode* to 4-7 *Special Settings and Communications Settings*.

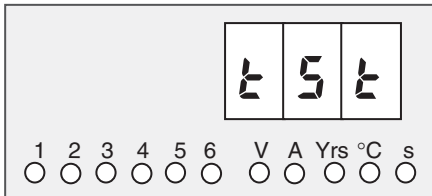
Note This option will not be displayed for models that do not permit changes in parameter settings (S8AS-24006/48008N).



If the  Key is pressed, TST will be displayed. If the  Key is pressed at this point, the S8AS will enter Test Mode.

Refer to SECTION 5 *Trial Operation to Actual Operation*.

Note If the protection level is set to level 2, this option will not be displayed for any models.

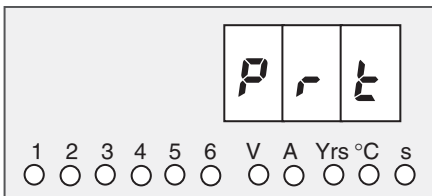



If the  Key is pressed, PRT (protect) will be displayed.

If the  Key is pressed at this point, the S8AS will switch to the protection level display.

Refer to 4-3 *Changing the Protection Level* for details on setting parameters.

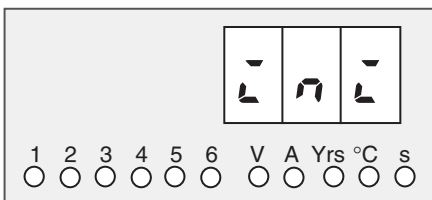
Note This option will not be displayed for models that do not permit change in parameter settings (S8AS-24006N/48008N).



If the protection level is set to level 0, INI will be displayed when the  Key is pressed.

If the  Key is pressed at this point, the S8AS will switch to the parameter initialization display.

Note

1. This option will not be displayed for models that do not permit change in parameter settings (S8AS-24006N/48008N).
2. The default protection level is level 1. At this level, the INI option will not be displayed for any models.



(If the  Key is pressed, the S8AS will return to the RUN display.)

Note The procedure for initializing parameters is given below. (Parameters cannot be initialized for the S8AS-24006N/48008N.)

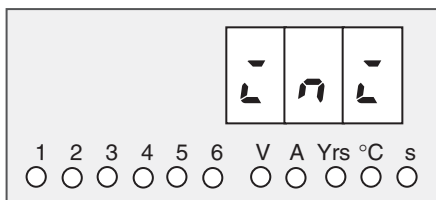

Press the Key from the initialize display (INI). The S8AS will switch to the parameter initialization display.



If the Key is pressed, NO will be displayed. Initialization cannot be performed from this display.

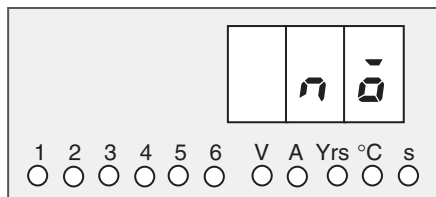

(The S8AS will automatically return to the Parameter Initialization Display (INI) if no key is pressed within 3 s.)



Press the Key. The display will change to YES. The parameters will be initialized if the Key is pressed from this display.

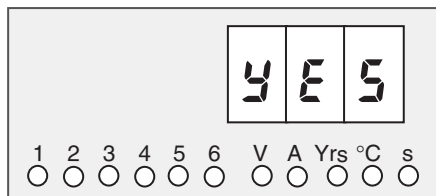

(The S8AS will automatically return to the Parameter Initialization Display (INI) if no key is pressed within 3 s.)



Flashing

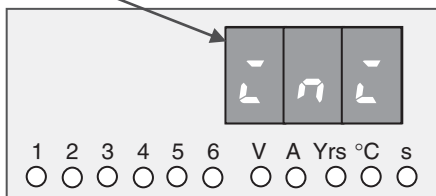

Press the Key to start initializing parameters.

INI will flash on the display while parameters are being initialized. When the display stops flashing, all parameters will have been initialized.

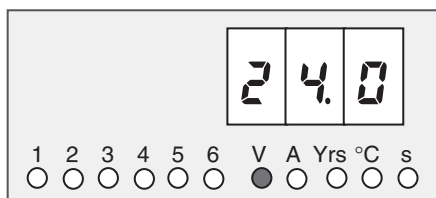

The operating mode will change to Run Mode.

After the parameters have been initialized, the default settings will be in effect and the initial power-ON status will be used.

- The operating mode will be Run Mode.
- All branch outputs will be connected.
- Protection level 1 will be used.

4-3 Changing the Protection Level

Operations Restricted in the Protection Levels

The protection level function can restrict parameter read/write access to one of three levels, as shown in the following table. (Refer to 4-1 Parameter Table)

Level	Applicable user	Access
Level 0	System administrator	All parameters can be read and changed.
Level 1	Supervisor	Only operational settings related to voltage and current can be read and changed.
Level 2	General staff	A limited number of parameters can be read. No parameters can be changed.

The default protection level is level 1. When the parameters are initialized, the protection level is set to level 1.

Procedure

The factory default protection level is level 1, so the protection level must be changed in order to switch to level 0. Use the following procedure to change the protection level.

Display the Mode Selection Menu and select the Protection Level setting (PRT).

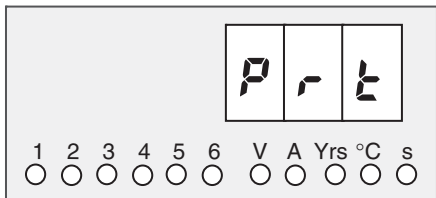

Press the Key.

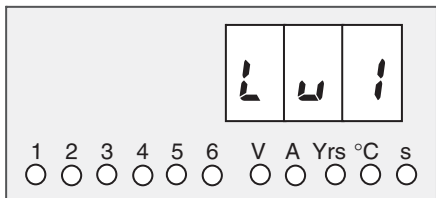

LV1 (level 1) will be displayed.

The present protection level is level 1 (the default value), so press the Key to change to level 0.

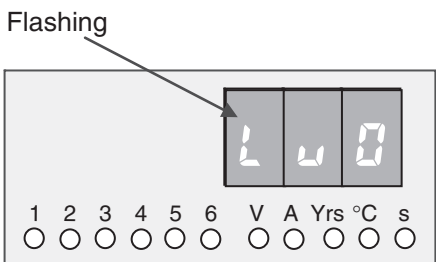

If the Key is pressed, the LV0 display will flash. When the display stops flashing, the protection level will be switched to level 0 and the S8AS will return to the Protection Level Setting (PRT).



(Returns to PRT.)

4-4 Switching to Setting Mode

When the S8AS is started, it will enter Run Mode. If the power was turned OFF while the S8AS was in Test Mode, it will start in Test Mode the next time it is started.

To switch to Setting Mode from Run Mode or Test Mode, select Setting Mode from the Mode Selection Menu, as shown below.

The Mode Selection Menu can be displayed by pressing both the Up (SEL) Key (⏮) and Down (CH) Key (⏭) simultaneously for 3 seconds.

Selecting the Operating Mode from the Mode Selection Menu

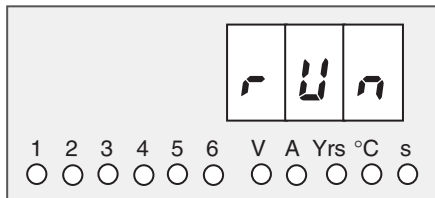

If the S8AS is switched to the Mode Selection Menu from Run Mode, RUN (select Run Mode) will be displayed.

Press the ⏮ Key.

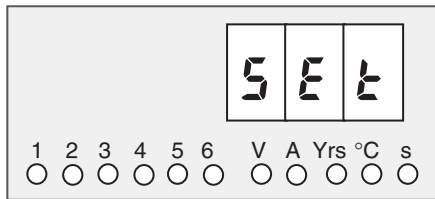

When the ⏮ Key is pressed, SET (select Setting Mode) will be displayed.

If the ⏭ Key is pressed, the S8AS will switch to Setting Mode.



The initial display for Setting Mode will be displayed.

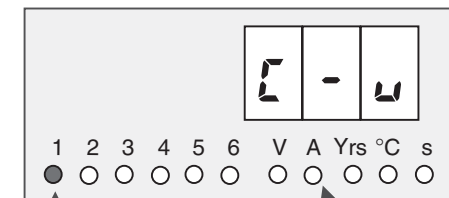

Branch output number 1 is lit.

The "A" unit indicator will be lit when a current is displayed.

The initial Setting Mode display is the abnormal current tripping threshold (C-V) for branch output 1.

The branch output that was most recently modified will be the current branch output regardless of the operating mode.

Once the S8AS is switched to Setting Mode, it will not return to Run Mode automatically.

(To return to Mode Selection Menu, press the ⏮ and ⏭ Keys simultaneously for 3 seconds again.)

For details on setting parameters in Setting Mode, refer to the following pages.

4-5 Individual Branch Output Settings

This section shows the displays and operations when setting parameters in Setting Mode in protection level 0. If the protection level is set to level 1 or 2, some parameters will not be displayed or will be read-only. (For details, see page 54.)

Setting the Abnormal Current Tripping Threshold: C-V (Cutoff Threshold Value)

The initial Setting Mode display (C-V) is used to set the abnormal current tripping threshold. (The branch output that was most recently modified will be the current branch output regardless of the operating mode.)

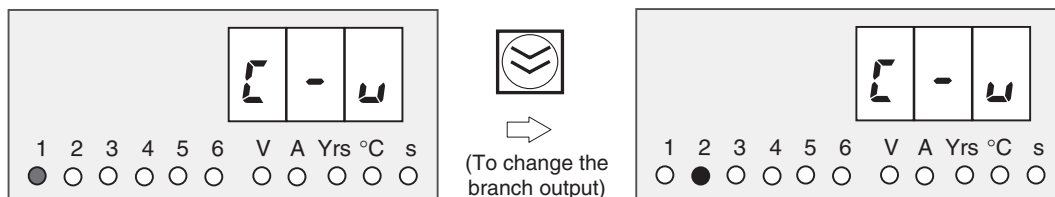

Switch to the current tripping type setting (C-T).

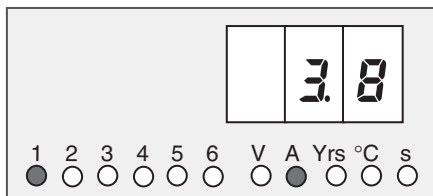

Press the Key to display the set value of the branch output 1 current tripping threshold.

The S8AS will automatically return to the C-V display if no key is pressed within 3 s.

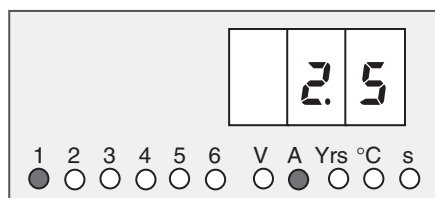

The set value can be changed by pressing the or Keys.

The setting range is 0.5 to 3.8 A (0.1-A increments).

- If the or Key is pressed for more than 2 s, the SV will change in 1.0-A increments instead of 0.1-A increments.



(Returns to C-V display.)

When the Key is pressed, the SV display will flash. When the flashing stops, the new SV will be saved and the S8AS will return to C-V display.

If you want to confirm the new setting, press the Key again from the C-V display.

Note If the branch output's current exceeds the threshold, the output will be cut off. The current tripping type is set with the following C-T (cutoff type) display. The tripping type can be set in protection level 0 only. After an output is cut off, the seven-segment display will alternately show error code A11 and the current, and the photoswitch output for Tripping Alarm Output (TRP) will be turned OFF. The error can be cleared immediately, but the next error cannot be cleared for another 15 s.

Setting the Abnormal Current Tripping Type: C-T (Cutoff Type)

This parameter can be set in protection level 0 only.

Select the current tripping type for the displayed branch output number.

(The branch output that was most recently modified will be the current branch output regardless of the operating mode.)

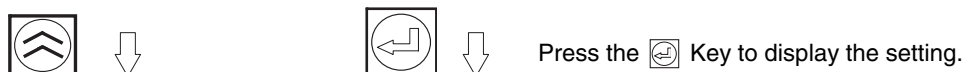
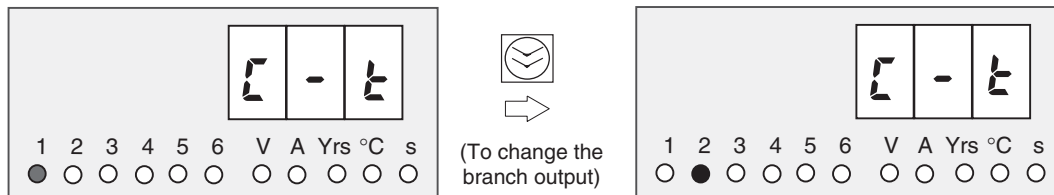

Switch to the Undervoltage Detection Output setting (V-U).

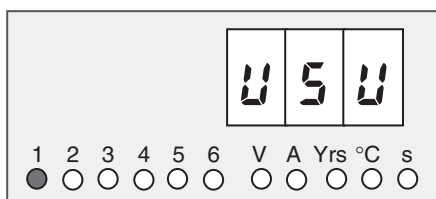

USU (Standard):
USU is an abbreviation of “usually.”
The output will be cut off within 100 ms.
INS (Instantaneous):
INS is an abbreviation of “instantaneous.”
The output will be cut off within 20 ms.
LGN (Extended detection):
LNG is an abbreviation of “long.”
The output will be cut off within 1,000 ms.

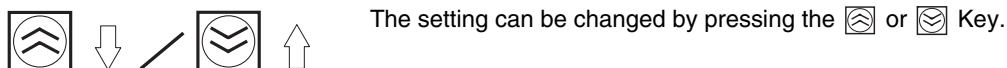

The S8AS will automatically return to the C-T display if no key is pressed within 3 s.

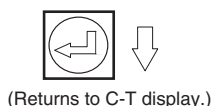
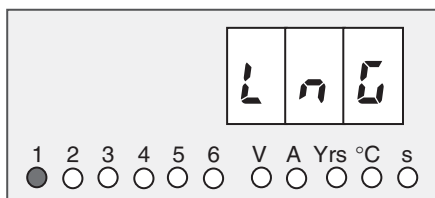
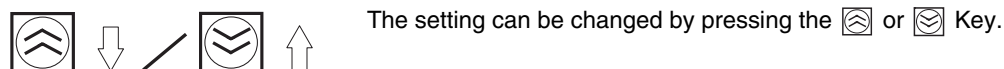
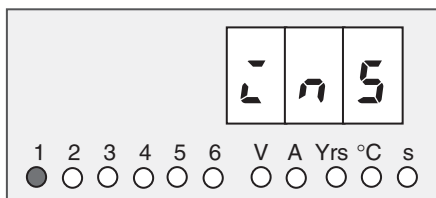

When the [Left Arrow] Key is pressed, the SV display will flash. When the flashing stops, the new SV will be saved and the S8AS will return to C-T display.

If you want to confirm the new setting, press the [Right Arrow] Key again from the C-T display.

Standard (標準)	When the current exceeds the tripping threshold for more than 80 ms, the branch output is cut off and the Tripping Alarm Output (TRP) is turned OFF. The output will be cut off within 100 ms.
Instantaneous (瞬時)	When the current exceeds the tripping threshold for more than 10 ms, the branch output is cut off and the Tripping Alarm Output (TRP) is turned OFF. The output will be cut off within 20 ms.
Extended (延長)	When the current exceeds the tripping threshold for more than 980 ms, the branch output is cut off and the Tripping Alarm Output (TRP) is turned OFF. The output will be cut off within 1,000 ms.

4-6 Shared Parameter Settings

Setting the Undervoltage Detection Output Value: V-U (Voltage Under)

After setting the abnormal current tripping threshold and tripping type for all branch outputs, press the Up (SEL) Key (⏏) to go to the Undervoltage Detection Threshold Display (V-U).

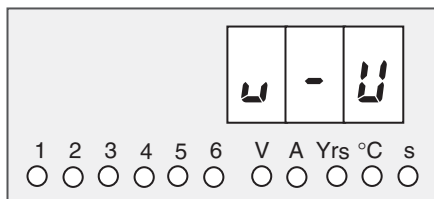

This parameter sets the undervoltage detection threshold.



Switch to the Maintenance Forecast Monitor Detection Threshold Setting (LFE).

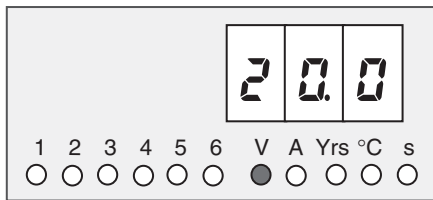

Press the ⏏ Key to display the undervoltage detection's set value (SV).

The SV can be changed by pressing the ⏏ and ⏏ Keys.

The setting range is 18.0 to 26.4 V (0.1-V increments).

- If the ⏏ or ⏏ Key is pressed for more than 2 s, the SV will change in 1.0-V increments instead of 0.1-V increments.

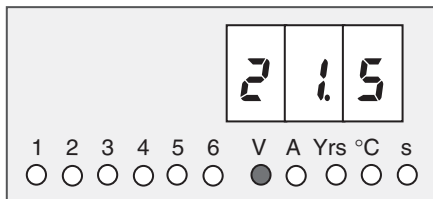

Change the SV with the ⏏ and ⏏ Keys.

The S8AS will automatically return to the V-U display if no key is pressed within 3 s.

When the ⏏ Key is pressed, the SV display will flash. When the flashing stops, the new setting will be saved and the S8AS will return to V-U display.

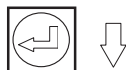

(Returns to V-U display.)

If you want to confirm the new setting, press the ⏏ Key again from the V-U display.

Note If the voltage remains below the detection threshold for 80 ms, the photo-switch output for the Undervoltage Detection Output (LOW) will turn OFF. At the same time, the seven-segment display will show the error code A21 and the voltage value.

The alarm output can be cleared after the voltage rises above the threshold +0.3 V for more than 500 ms.

Setting the Maintenance Forecast Monitor Detection Threshold: LFE (Life)

The Maintenance Forecast Monitor Detection Threshold Setting (LFE) will be displayed if the Up (SEL) Key () is pressed from the Undervoltage Detection Threshold Setting Display (V-U).

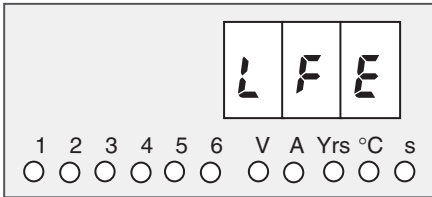



This parameter sets the maintenance forecast monitor output.



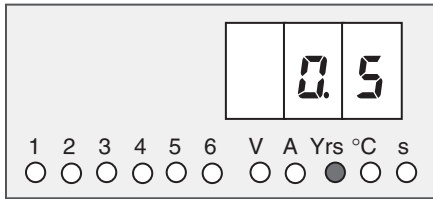

Switch to the Over-temperature Output Threshold Setting (TMP).





Press the  Key to display the set value (SV). The SV can be changed by pressing the  and  Keys.

The setting range is 0 to 5 years, in 0.5-year increments.

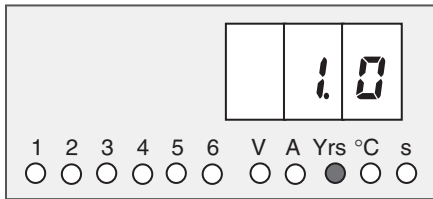
- If the  or  Key is pressed for more than 2 s, the SV will change in 1.0-V increments instead of 0.5-V increments.



Change the SV with the  and  Keys.

The S8AS will automatically return to the LFE display if no key is pressed within 3 s.

When the  Key is pressed, the SV display will flash. When the flashing stops, the new setting will be saved and the S8AS will return to LFE display.



(Returns to LFE display.)

If you want to confirm the new setting, press the  Key again from the LFE display.

Note The maintenance forecast monitor output is an estimate of the lifetime of the electrolytic capacitor in the power supply circuit. It is calculated from the power-ON time and internal temperature. When the estimated lifetime falls below the threshold value, the maintenance forecast monitor output (LFE) photoswitch output will turn OFF, and the seven-segment display will alternately show error code A23 and the remaining lifetime (in 0.5-year increments).

Setting the Over-temperature Output Threshold: TMP (Temperature)

The Over-Temperature Output Threshold Setting (TMP) will be displayed if the Up (SEL) Key () is pressed from the Maintenance Forecast Monitor Detection Threshold Setting (LFE).

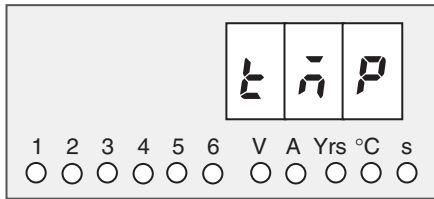



This parameter sets the over-temperature output threshold.



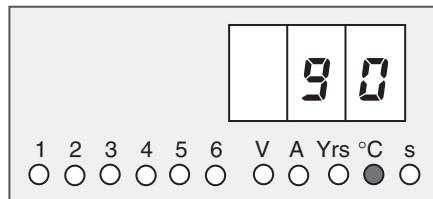

Switch to the start-up sequence setting (UPS).





Press the  Key to display the over-temperature output threshold (SV). The SV can be changed by pressing the  and  Keys.

The setting range is 25°C to 90°C



Change the SV with the  and  Keys.

- The S8AS will automatically return to the TMP display if no key is pressed within 3 s.

- If the  or  Key is pressed for more than 2 s, the SV will change in 10°C increments instead of 1°C increments.

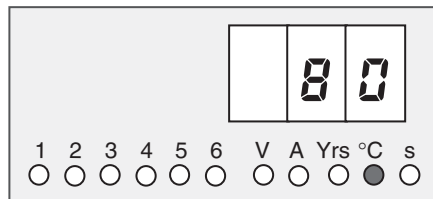

When the  Key is pressed, the SV display will flash. When the flashing stops, the new setting will be saved and the S8AS will return to TMP display.



(Returns to TMP display.)

If you want to confirm the new setting, press the  Key again from the TMP display.

Note

- If the temperature exceeds the threshold value for more than 1 s, the over-temperature output (TMP) photoswitch output will turn OFF and the seven-segment display will alternate between error code A30 and the measured temperature.
- The error display and over-temperature output are reset automatically after the temperature falls and remains below the threshold value minus 3°C for longer than 5 s.
- The over-temperature output (TMP) operates independently of the other external outputs. This output can be received as a normally closed output and used to start an exhaust fan or air conditioner to reduce the temperature in the control panel.



4-7 Special Settings and Communications Settings



The Startup Sequence Setting (UPS) will be displayed if the S8AS is in protection level 0 and the Up (SEL) Key () is pressed from the Over-Temperature Output Threshold Setting Display (TMP), which was described at the end of 4-6 Shared Parameter Settings.

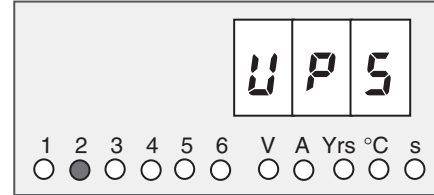
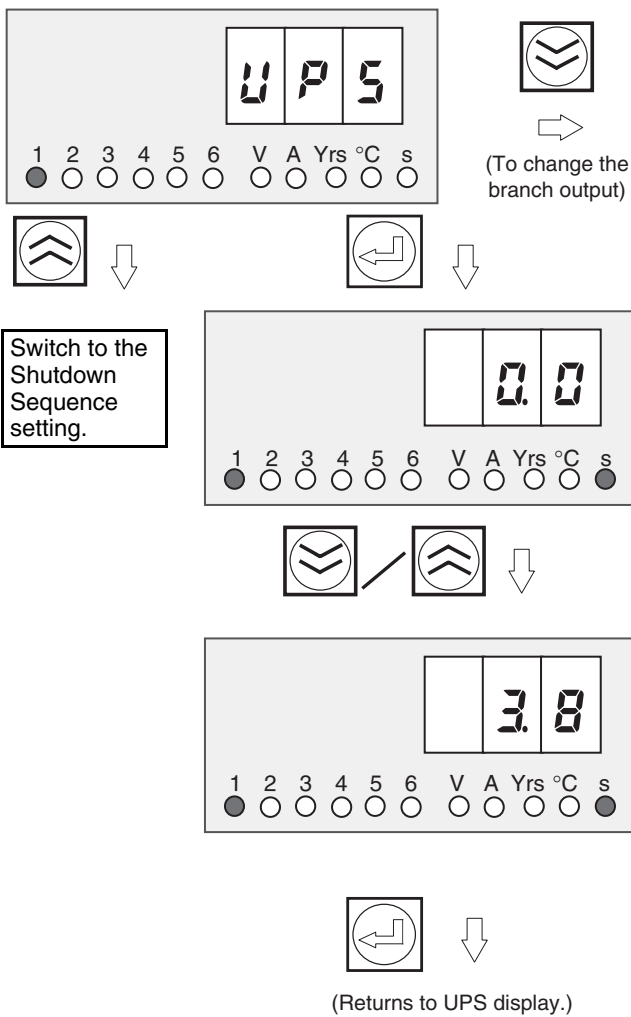

Setting the Startup Sequence: UPS (Startup Sequence)

The startup sequence sets the startup sequence time for each branch output. (The branch output that was most recently modified will be the current branch output regardless of the operating mode.)





Press the  Key to display the startup sequence time set value (SV) for the current branch output. The SV can be changed by pressing the  and  Keys. The setting range is 0.0 to 99.9 s (0.1-s increments).

Note If the  or  Key is pressed for more than 2 s, the SV will change in 1.0-s increments instead of 0.1-s increments.

Change the SV with the  and  Keys. The S8AS will automatically return to the UPS display if no key is pressed within 3 s.

When the  Key is pressed, the SV display will flash. When the flashing stops, the new setting will be saved and the S8AS will return to UPS display.

If you want to confirm the new setting, press the  Key again from the UPS display.



To change the startup sequence settings of other branch outputs, press the  Key from the UPS display to select the desired branch output, and then follow the procedure to change the settings.

Note The startup sequence sets a delay before the S8AS connects the branch output after the power is turned ON. Connecting the branch outputs in sequence instead of simultaneously can reduce the inrush current and reduce the load on the power supply. For details on the startup sequence, refer to 2-5 Startup Sequence Function.

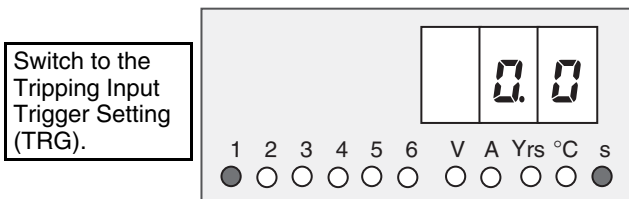
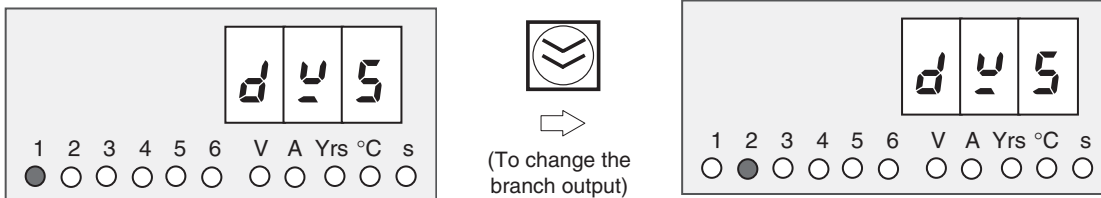

Setting the Shutdown Sequence: DWS (Shutdown Sequence)

The Shutdown Sequence Setting (DWS) will be displayed if the Up (SEL) Key () is pressed from the Startup Sequence Setting Display. The shutdown sequence sets the shutdown sequence time for each branch output. (The branch output that was most recently modified will be the current branch output regardless of the operating mode.)



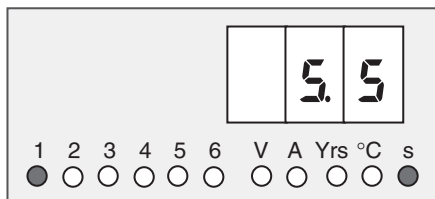

Press the  Key to display the Shutdown Sequence Time Set Value (SV) for the current branch output. The SV can be changed by pressing the  and  Keys. The setting range is 0.0 to 99.9 s (0.1-s increments).





Change the SV with the  and  Keys.

The S8AS will automatically return to the DWS display if no key is pressed within 3 s.

If the  or  Key is pressed for more than 2 s, the SV will change in 1.0-s increments instead of 0.1-s increments.

When the  Key is pressed, the SV display will flash. When the flashing stops, the new setting will be saved and the S8AS will return to DWS display.

- If you want to confirm the new setting, press the  Key again from the DWS display.
- To change the shutdown sequence of other branch outputs, press the  Key from the DWS display to select the desired branch output, and then follow the procedures to change the settings.



Note The shutdown sequence function sets the time that the S8AS waits before cutting off each branch output when the branch outputs are cut off by the external tripping input or communications. For details on the startup sequence, refer to 2-6 Shutdown Sequence Function.

Tripping Input Trigger Setting: TRG (Trigger)

The Tripping Input Trigger Setting (TRG) will be displayed if the Up (SEL) Key (⏏) is pressed from the Shutdown Sequence Setting Display.

The tripping input (TRG) can be enabled or disabled independently for each branch output.

(The branch output that was most recently modified will be the current branch output regardless of the operating mode.)

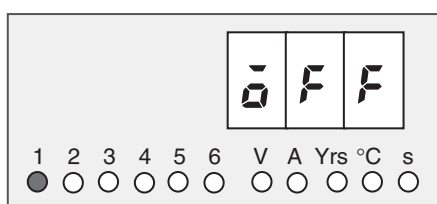
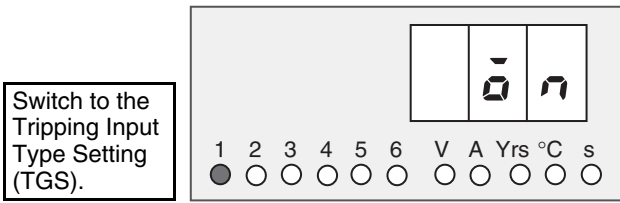
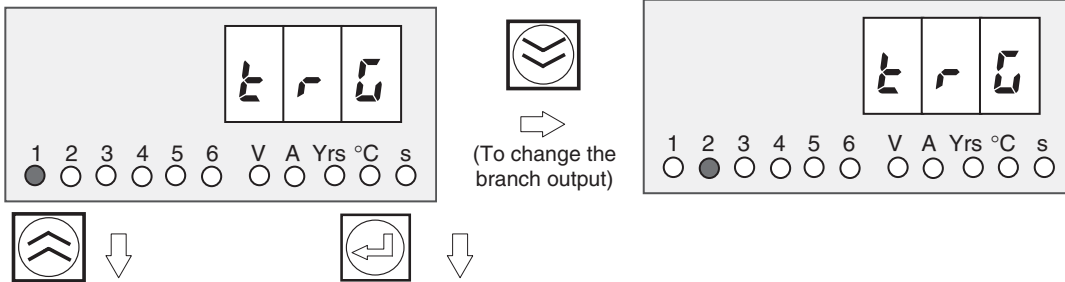

Press the Key to display the branch output parameter settings.

The setting can be changed by pressing the or Key.

ON (enabled): The corresponding branch output will be cut off when the TRG input is ON.

OFF (disabled): The TRG input has no effect on the corresponding branch output.

Change the setting with the or Key.

- The S8AS will automatically return to the TRG display if no key is pressed within 3 s.

When the Key is pressed, the SV display will flash. When the flashing stops, the new setting will be saved and the S8AS will return to TRG display.

- If you want to confirm the new setting, press the Key again from the TRG display.
- To change the tripping input trigger setting of other branch outputs, press the Key from the TRG display to select the desired branch output, and then follow the procedure to change the settings.

- Note**
- (1) If the External Tripping Input (TRG) is enabled for any branch outputs, those outputs will be cut off within 20 ms when the TRG input is ON for more than 10 ms.
 - (2) The shutdown delays specified by the shutdown sequence times will be applied before disconnecting each output.
 - (3) When the TRG input goes ON, the seven-segment display will indicate "TRG."

- (4) Once the TRG input goes OFF, the cut-off branch outputs can be reconnected by pressing the Reset Key.
- (5) When all outputs are cut off simultaneously in Test mode or the shutdown sequence operation is executed via communications, the branch outputs will be cut off regardless of the external tripping input trigger setting.

Tripping Input Type: TGS (Trigger Sense)

The Tripping Input Condition Setting (TGS) will be displayed if the Up (SEL) Key (⏏) is pressed from the External Tripping Input Trigger Setting Display (TRG).

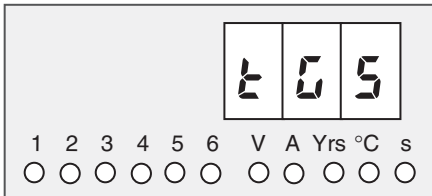

This parameter sets the tripping input type for each branch output that has tripping input (TRG) enabled.



Switch to the Communications Unit No. Setting (UNO) for models with communications. (See note.)

Note: For models without communications, switch to Reset Method Setting (page 76).

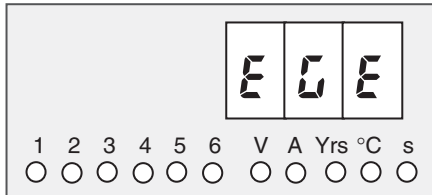

Press the ⏏ Key to display the tripping input type.

The setting can be changed by pressing the ⏏ or ⏏ Key.
 EGE (Edge): Output is cut off when TRG input changes from OFF to ON.

LVL (Level): Output is cut off when TRG input changes from OFF to ON, and is connected when TRG input changes from ON to OFF.

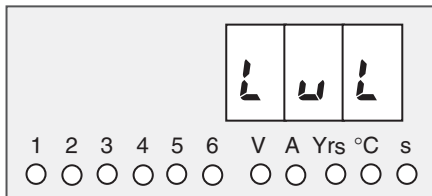

Change the setting with the ⏏ or ⏏ Key.

- The S8AS will automatically return to the TGS display if no key is pressed within 3 s.

When the ⏏ Key is pressed, the SV display will flash. When the flashing stops, the new setting will be saved and the S8AS will return to TGS display.

- If you want to confirm the new setting, press the ⏏ Key again from the TGS display.



(Returns to TGS display.)

Unit Number Setting: UNO (Unit Number)

The Unit Number Setting (UNO) will be displayed if the Up (SEL) Key () is pressed from the External Tripping Input Type Display (TGS).

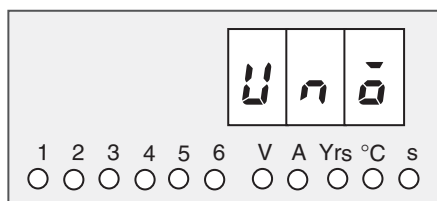





Set the S8AS's unit number when using 1:N communications with the host computer.

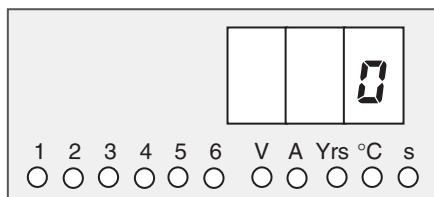



Switch to the Baud Rate Setting (BPS).



Press the  Key to display the unit number setting. The setting can be changed by pressing the  and  Keys.

- If the  or  Key is pressed for more than 2 s, the SV will change by 10s instead of 1s.

The setting range is 0 to 31.

Change the SV with the  and  Keys.

- The S8AS will automatically return to the UNO display if no key is pressed within 3 s.

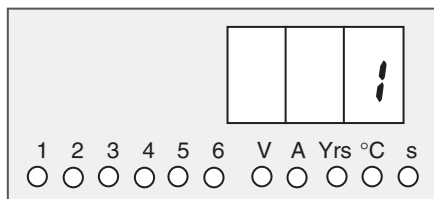

When the  Key is pressed, the setting will flash. When the flashing stops, the new setting will be saved and the S8AS will return to UNO display.

- If you want to confirm the new setting, press the  Key again from the UNO display.

(Returns to UNO display.)

Baud Rate: BPS (Bits Per Second)

The Baud Rate Setting (BPS) will be displayed if the Up (SEL) Key () is pressed from the Unit Number Setting Display (UNO).

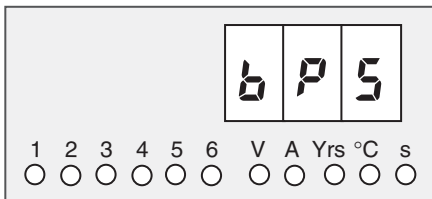



This parameter sets the RS485 port's baud rate to 4,800 bps or 9,600 bps.

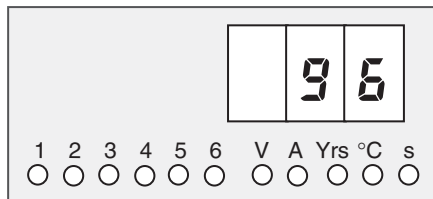

Switch to the data length setting (LEN).





Press the  Key to display the baud rate setting. The setting can be changed by pressing the  or  Key.

96: 9,600 bps

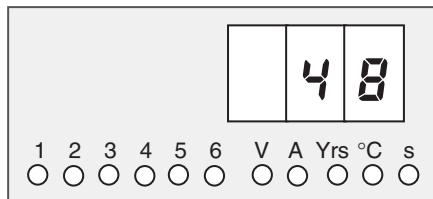
48: 4,800 bps



Change the setting with the  or  Key.

- The S8AS will automatically return to the BPS display if no key is pressed within 3 s.

When the  Key is pressed, the setting will flash. When the flashing stops, the new setting will be saved and the S8AS will return to the "BPS" display.

If you want to confirm the new setting, press the  Key again from the BPS display.



(Returns to BPS display.)

Data Length: LEN (Bit Length)

The Data Length Setting (LEN) will be displayed if the Up (SEL) Key () is pressed from the Baud Rate Setting Display (BPS).

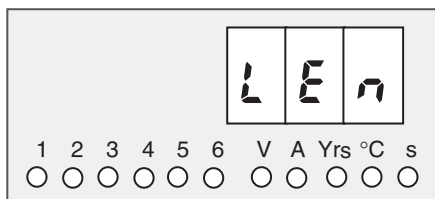



This parameter sets the data length to 7 or 8 bits.



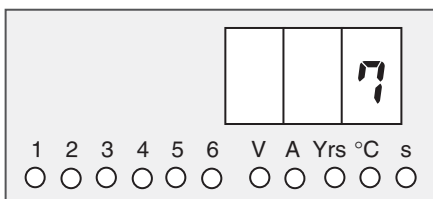

Switch to the Stop Bits Setting (BIT).



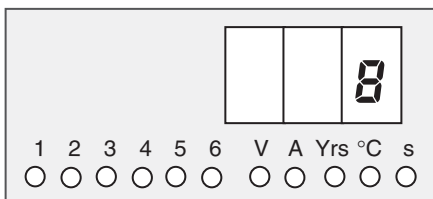

Press the  Key to display the data length setting.
 The setting can be changed by pressing the  or  Key.
 7: 7 bits
 8: 8 bits



Change the setting with the  or  Key.
 • The S8AS will automatically return to the LEN display if no key is pressed within 3 s.



(Returns to LEN display.)

When the  Key is pressed, the setting will flash. When the flashing stops, the new setting will be saved and the S8AS will return to the LEN display.
 • If you want to confirm the new setting, press the  Key again from the LEN display.

Stop Bit Setting: BIT (Stop Bits)

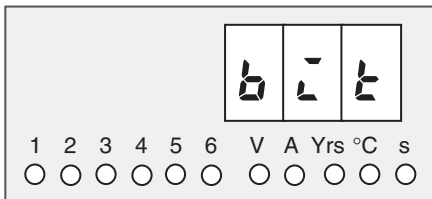

The Stop Bit Setting (BIT) will be displayed if the Up (SEL) Key () is pressed from the Data Length Setting Display (LEN).

This parameter sets the number of stop bits to 1 bit or 2 bits.

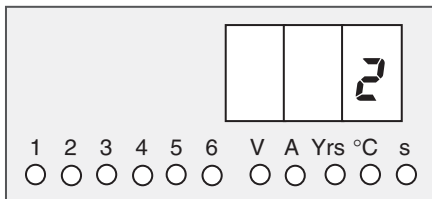

Switch to the Parity Setting (PTY).



Press the  Key to display the stop bit setting. The setting can be changed by pressing the  or  Key.

- 1: 1 bit
- 2: 2 bits

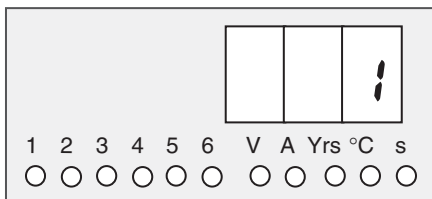

Change the setting with the  or  Key.

- The S8AS will automatically return to the "BIT" display if no key is pressed within 3 s.

When the  Key is pressed, the setting will flash. When the flashing stops, the new setting will be saved and the S8AS will return to the "BIT" display.

- If you want to confirm the new setting, press the  Key again from the "BIT" display.

(Returns to BIT display.)

Parity Setting: PTY (Parity Bit)

The Parity Setting (PTY) will be displayed if the Up (SEL) Key () is pressed from the Stop Bit Setting Display (BIT).

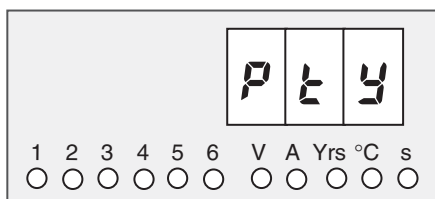



This parameter sets the parity to none, even, or odd.

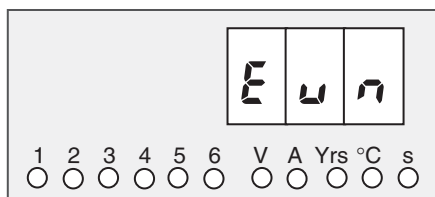

Switch to the Send Wait Time Setting (SWT).



Press the  Key to display the parity setting.

The setting can be changed by pressing the  and  Keys.

Evn: Even
odd: Odd
non: None

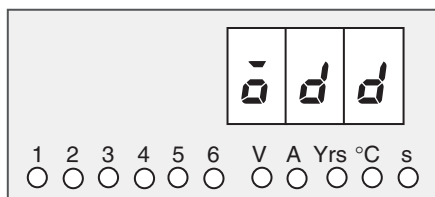

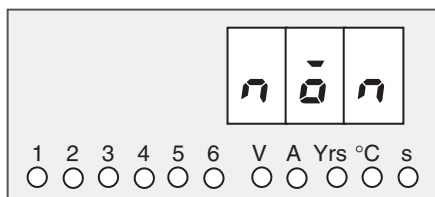

Change the setting with the  or  Key.

• The S8AS will automatically return to the TMP display if no key is pressed within 3 s.



Change the setting with the  or  Key.

When the  Key is pressed, the setting will flash. When the flashing stops, the new setting will be saved and the S8AS will return to the PTY display.

If you want to confirm the new setting, press the  Key again from the PTY display.

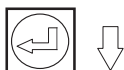

(Returns to PTY display.)

Send Wait Time: SWT (Send Wait Time)

The Send Wait Time Setting (SWT) will be displayed if the Up (SEL) Key () is pressed from the Parity Setting Display (PTY).

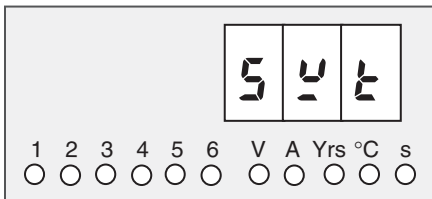



This parameter sets the RS-485 port's send wait time.

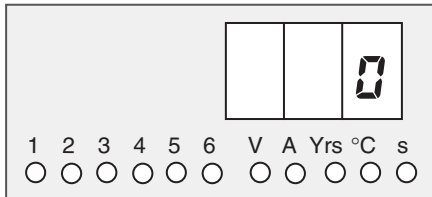

Switch to the Reset Method Setting (RST).





Press the  Key to display the send wait time setting.



The setting can be changed by pressing the  and  Keys.

The setting range is 0 to 999 ms.

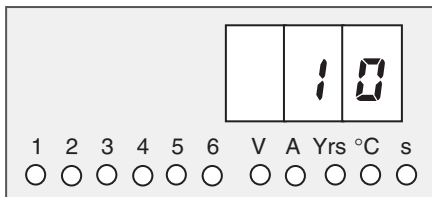

Change the setting with the  and  Keys.





- If the  or  Key is pressed for more than 2 s, the SV will change in 10-ms increments instead of 1-ms increments.

- The S8AS will automatically return to the SWT display if no key is pressed within 3 s.



(Returns to SWT display.)

When the  Key is pressed, the setting will flash. When the flashing stops, the new setting will be saved and the S8AS will return to SWT display.

- If you want to confirm the new setting, press the  Key again from the SWT display.

Reset Method Setting: RST (Reset)

The error resetting method can be set. This method will be used to reset errors after eliminating the cause of the error.

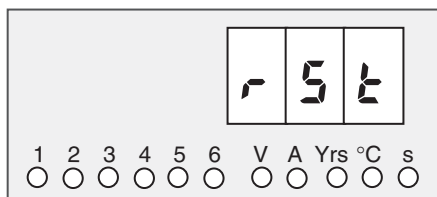



This parameter sets the error reset method.

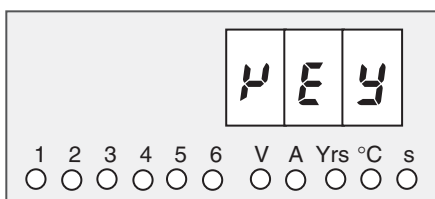

Switch to the Abnormal Current Tripping Threshold Setting (C-V).



Press the  Key to display the send wait time setting.

The setting can be changed by pressing the  or  Key.

KEY: Errors can be reset using the S8AS Reset Key only.
 ALL: Errors can be reset using the S8AS Reset Key or by turning the power supply OFF.



Change the setting with the  or  Key.

- The S8AS will automatically return to the RST display if no key is pressed within 3 s.

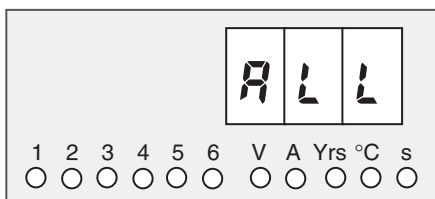

When the  Key is pressed, the setting will flash.

When the flashing stops, the new setting will be saved and the S8AS will return to the RST display.



(Returns to RST display.)

SECTION 5

Trial Operation to Actual Operation

A connection/disconnection test can be performed on each branch output in Test Mode.

When the S8AS is shipped from the factory, all branch outputs are connected.

If you want to set unused branch outputs so that they are not connected, set those outputs to OFF in Test Mode.

5-1	Test Mode	78
5-2	Connection/Disconnection Test	80
5-3	Checking Sequence Operation	81
5-4	Run Mode	82

5-1 Test Mode

Each branch output's connection status can be checked and the outputs can be connected manually in Test Mode before starting actual operation of the equipment.

The S8AS must be set to protection level 0 or 1 in order to switch to Test Mode. (It is not possible to switch to Test Mode when the S8AS is set to protection level 2.)

Precautions when Checking Operation

Before checking operation in Test Mode, always confirm that it is safe to do so and will not adversely affect the system.

Setting the Branch Outputs That Will Be Used

The S8AS is a power supply unit. When it is shipped from the factory, all branch outputs are set to "ON" (connected). After setting the parameters in Setting Mode, change the connection status as required and then check them.



Errors Occurring During the Connection Test



When an error occurs in Test Mode or the external tripping input is turned ON, the tripping operation will be executed and the appropriate external output will be turned OFF, but the error code will not be displayed.

When the S8AS is switched to Run Mode, the error code will be displayed.

In Test Mode, the abnormal tripping output (TRP) will operate if one or more of the branch outputs are not connected. (The photoswitch outputs will turn OFF.) No error code will be output. This type of TRP output is unique to the Test Mode and will not be retained if the operating mode is changed.

Switching to Test Mode

Press the  Key and the  Key together for at least 3 s to switch to the Mode Selection Menu and select Test Mode.



Once the S8AS has been switched to Run Mode, it will start in either Run Mode or Test Mode (see note) the next time that the power is turned ON, so press the  and the  Keys together for at least 3 s to switch to the Mode Selection Menu.

Note When the S8AS is turned OFF in Test Mode, it will restart in Test Mode.

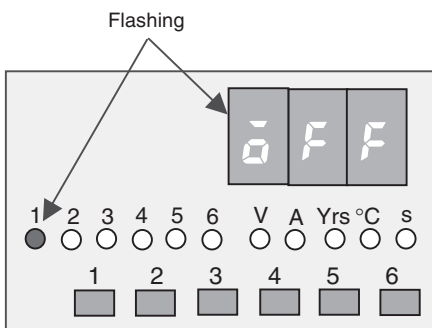
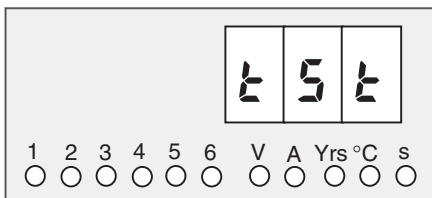
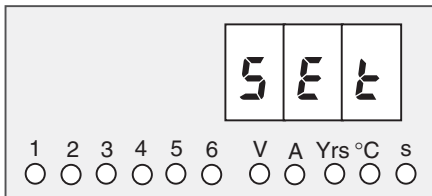
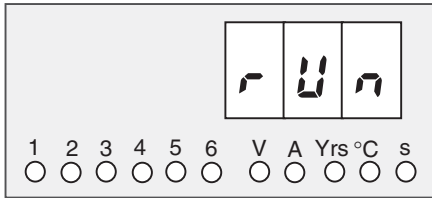

Operations and Displays in the Mode Selection Menu



If the S8AS is switched to the Mode Selection Menu from Run Mode, RUN will be displayed on the seven-segment display. If the S8AS is switched to the Mode Selection Menu from Setting Mode, SET will be displayed on the seven-segment display.

If the  Key is pressed, SET will be displayed. At this point, the S8AS will switch to Setting Mode if the  Key is pressed.

- You cannot switch to Setting Mode if using models that do not allow changes to settings (S8AS-24006N/48008N).

If the  Key is pressed, TST will be displayed. At this point, the S8AS will switch to Test Mode if the  Key is pressed.

Press the  Key to change to Test Mode.

The flashing "OFF" display indicates that the S8AS is ready to disconnect branch output 1.

Pressing the  Key at this point will disconnect branch output 1.

5-2 Connection/Disconnection Test

Before performing the connection/disconnection test in Test Mode, always confirm that it is safe to do so and will not adversely affect the system.

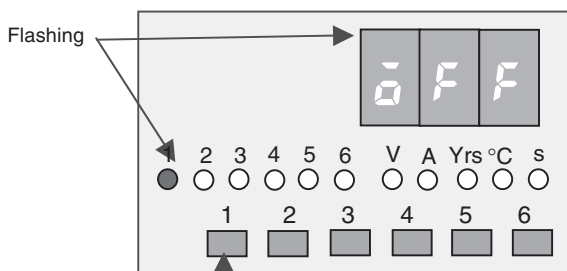

All of the branch output status indicators will be lit.

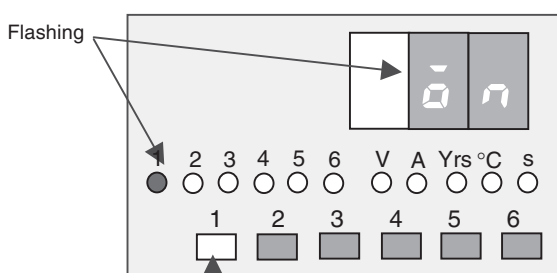

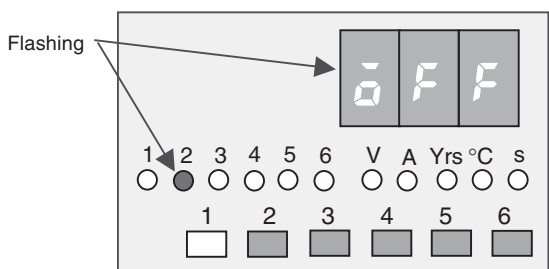

The status indicator of branch output 1 will go OFF.





The flashing "OFF" display indicates that the S8AS is ready to disconnect branch output 1.

To disconnect branch output 1, press the  Key.

If the  Key is pressed, branch output 1 will be disconnected and the output 1 indicator will go OFF. The seven-segment display will flash the "ON" to indicate that the S8AS is ready to connect branch output 1.

If the  Key is pressed again, branch output 1 will be connected.

To test another branch output, press the  Key to change the branch output.



If the  Key is pressed, the branch output 2 indicator will begin to flash, indicating that the S8AS is ready to disconnect branch output 2.

To disconnect branch output 2, press the  Key.

Use the above procedure to test connecting and disconnecting the branch outputs and set the branch outputs that are to be used to "ON."

Note Be sure to set the branch outputs that will be used to "ON." If a branch output is not set to "ON" when the S8AS is switched to Run Mode, that branch output cannot be used.

If the  Key is pressed a second time when testing the branch outputs, the indicators for all branch outputs will flash and all branch outputs can be connected and disconnected at the same time.

To move to another mode after testing the branch outputs, press both the  Key and  Key together for at least 3 seconds to switch to the Mode Selection Menu.

5-3 Checking Sequence Operation

When you want to check the operation of the startup sequence function or shutdown sequence function, press  Key until all of the branch output indicators are flashing.

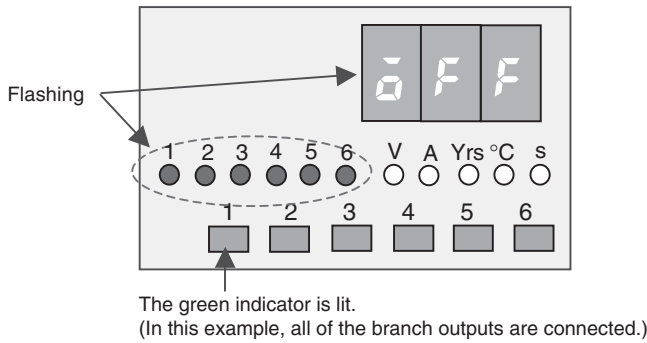

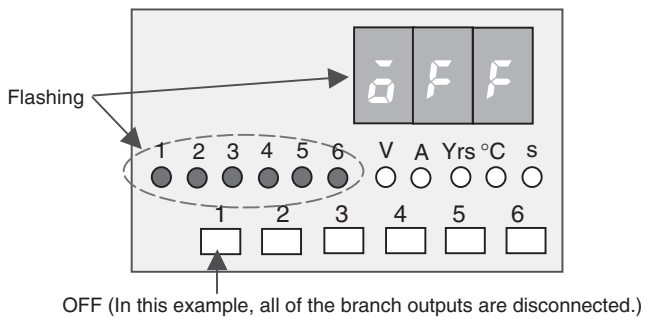

Press the  Key while testing individual branch outputs until all branch output indicators start flashing.

At this point, the operation all branch inputs can be checked simultaneously. When the "OFF" display is flashing, it indicates that the S8AS is ready to simultaneously disconnect all of the branch outputs.



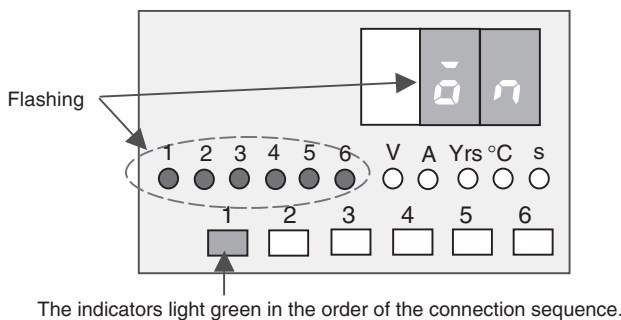

If the  Key is pressed, the S8AS starts cutting off all the branch outputs, and the outputs will be cut off in the pattern specified in the shutdown sequence if the shutdown sequence has been set.



When checking the startup sequences operation, press the  Key to switch to the flashing "ON" display.

If the  Key is pressed, the S8AS starts connecting all the branch outputs, and the outputs will be connected in the pattern specified in the startup sequence if the startup sequence has been set.

The indicators for the branch outputs that are ready to be connected will flash green.

To return to Run Mode after completing the test, press the  Key and the  Key simultaneously for at least 3 s. The display will return to the Mode Selection Menu's TST display. Specify the next operation mode.



If the S8AS is turned OFF in Test Mode, it will restart in Test Mode the next time that the power is turned ON. All branch outputs will retain the connection status when power is OFF.

5-4 Run Mode

Switch to Run Mode after making connection settings and testing operation in Test Mode. In Run Mode, the output voltage, present currents for branch outputs, peak output currents for branch outputs, total current, maintenance forecast monitor output, and internal temperature can be displayed. The peak output currents can also be cleared.

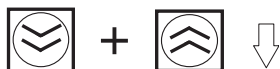
Moving from Test Mode to Run Mode



Press the  Key and the  Key simultaneously for at least 3 s. The display will return to the Mode Selection Menu.

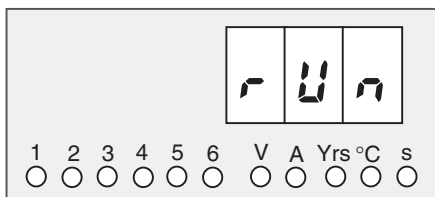
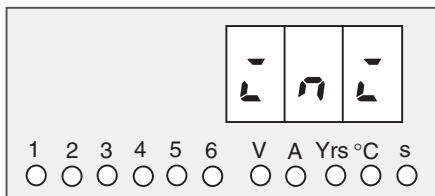
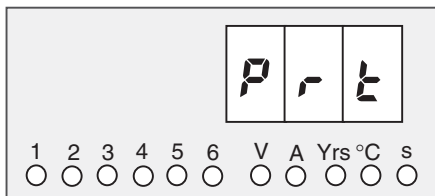
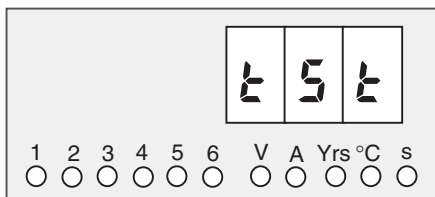

Press the  Key while "RUN" is being displayed to move to Run Mode.

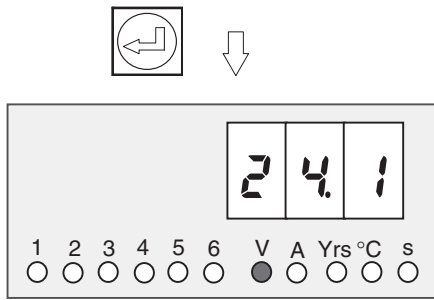

When Run Mode is entered, one of the following will be displayed: the output voltage, branch output current, total output current, maintenance forecast monitor output, or internal temperature. In this example, the output voltage is displayed.

Operations in Run Mode

In Run Mode, the output voltage, present currents for branch outputs, peak output current for branch outputs, total current, maintenance forecast monitor output, and internal temperature can be monitored regardless of the protection level. The peak output currents can also be cleared.

Display	Branch output number indicators					Unit indicators				
	1	2	3	to	6 (8) (See note 3.)	V	A	Yrs	°C	s
Output voltage	○	○	○	to	○	●	○	○	○	○
Total output current of all branch outputs (See note 2.)	●	●	●	to	●	○	●	○	○	○
Present current of branch output 1	●	○	○	to	○	○	●	○	○	○
Peak output current of branch output 1 (See note 1.)	●	○	○	to	○	○	★	○	○	○
Present current of branch output 2	○	●	○	to	○	○	●	○	○	○
Peak output current of branch output 2	○	●	○	to	○	○	★	○	○	○
to				to						
Present current of branch output with maximum number	○	○	○	to	●	○	●	○	○	○
Peak current of branch output with maximum number	○	○	○	to	●	○	★	○	○	○
Maintenance forecast monitor output	○	○	○	to	○	○	○	●	○	○
Internal temperature	○	○	○	to	○	○	○	○	●	○

○ :Not lit
 ● :Lit
 ★ :Flashing

- Note**
- (1) The procedure for clearing peak output currents is given below.
 - (2) Displays the sum of the present currents of all branch outputs
 - (3) The branch output with the maximum number.

Clearing the Peak Output Current Value

The peak output currents can be cleared. Clearing is possible in any protection level. The procedure for clearing the peak output current for branch output 1 is given below.

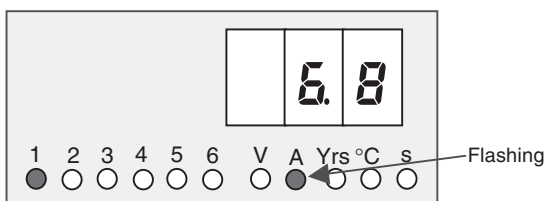

Press the Key until the "A" unit indicator flashes. When the "A" unit indicator is lit, the branch output current is being displayed. When the "A" unit indicator is flashing, the branch output peak current is being displayed.



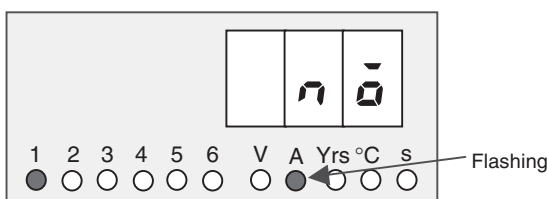

If the Key is pressed while the peak current is being displayed, the peak current will be cleared.

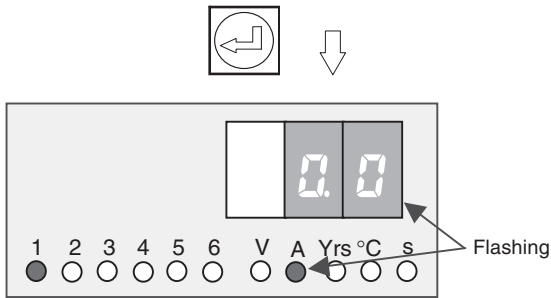
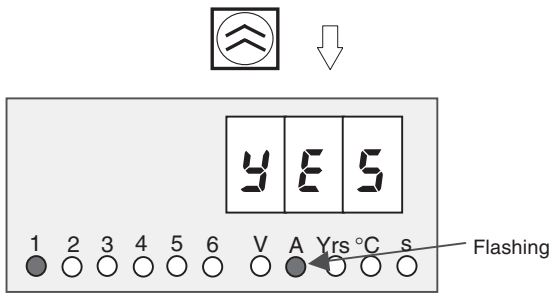

Press the Key. "NO" will be displayed. Clearing is not possible from this display, so press the Key to change the display to "YES."

(If no keys are pressed within 5 s, the S8AS will automatically return to the last display.)



Press the  Key. Clearing the peak time will be started and "0.0" will flash on the display.

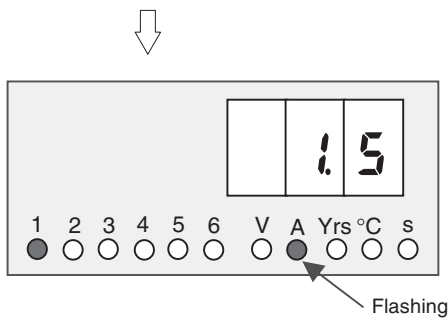

When "0.0" stops flashing, the clear process has been completed and the present current will be displayed as the peak output current.

Note

- (1) The S8AS, however, has a current-restricting function, so the peak value is not necessarily an accurate measure of the peak inrush current of the connected device.
- (2) Due to the startup delay the peak output current display value may be greater than the abnormal current tripping threshold.

SECTION 6

Communications

This section describes the communications provided by the S8AS.

6-1	CompoWay/F Communications Specifications	88
6-2	Frame Structure	90
6-2-1	Command Frame Structure	90
6-2-2	Response Frame Structure	91
6-2-3	FINS-mini Structure	94
6-3	Variable Area Operations	99
6-4	Read Controller Information	102
6-5	Read Controller Attributes	103
6-6	Read Controller Status	104
6-7	Echoback Test	106
6-8	Operation Command	107
6-9	Response Code List	109
6-10	ASCII List	110

6-1 CompoWay/F Communications Specifications

The S8AS-□□□□□R is equipped with an RS-485 port, which allows remote monitoring and remote operations over networks, such as setting parameters, connecting/disconnecting outputs, and clearing errors.

Connecting to the Network

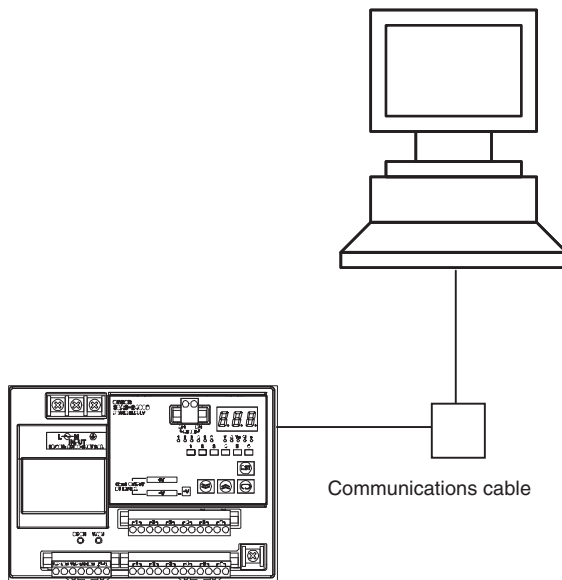

Refer to *3-4 RS-485 Port Wiring* for details on connecting the communications cable.

Communications Specifications

Connection configuration	1:n connection
Communications method	RS-485
Synchronization method	Start-stop synchronization
Baud rate	4,800 or 9,600 bps (Default value: 9,600 bps)
Transmission code	ASCII
Data length	7 or 8 bits (Default value: 7 bits)
Stop bits	1 or 2 bits (Default value: 2 bits)
Error detection	Vertical parity: None, even, or odd (Default value: Even) BCC (block check character)
Flow control	None
Retry function	None

**Communications
Control Method**

Programs can be created in the host computer (e.g., a personal computer) to set or monitor parameters in the S8AS. Therefore the descriptions in this section are from the standpoint of the host computer.

CompoWay/F is OMRON's unified communications protocol for general-purpose serial communications. This unified format has a proven track record with OMRON Programmable Controllers, has FINS-compliant commands (see note), and simplifies communications between the host computer and components.

Note FINS (Factory Interface Network service) is a messaging protocol for communications between Controllers in OMRON FA networks.

The S8AS has the following communications functions:

- Reading settings and data
- Executing operation commands
- Switching setting levels

The following restriction applies to the communications functions:

- Settings data can be written only when writing is allowed through communications.

6-2 Frame Structure

6-2-1 Command Frame Structure

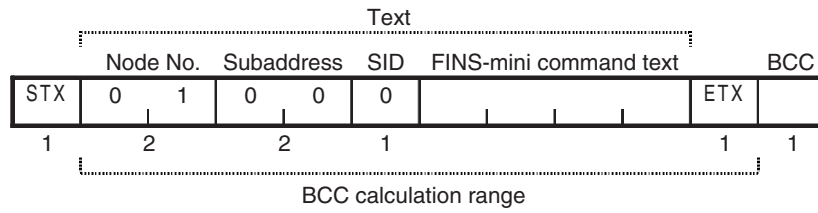

STX	This code, 02 hex, indicates the beginning of a communications frame (text). This code must always be set as the first byte. When another STX code is received during reception, the reception starts again from the point where the STX was received.
Node No. (Node address)	<ul style="list-style-type: none"> • The node address identifies the destination node. • The node address can be set to 00 to 32. • There will be no response to a transmission with an invalid node address.
Subaddress	The subaddress is not used in the S8AS. Always set the subaddress to "00."
SID (Service ID)	The SID is not used in the S8AS. Always set the SID to "0."
FINS-mini command text	The command and required text are placed here. Refer to 6-2-3 <i>FINS-mini Structure</i> for details.
ETX	This code, 03 hex, indicates the end of text.
BCC	This is the block check character. The BCC is calculated by taking the exclusive OR of all bytes from the node number to the ETX.

6-2-2 Response Frame Structure

■ Normal Response

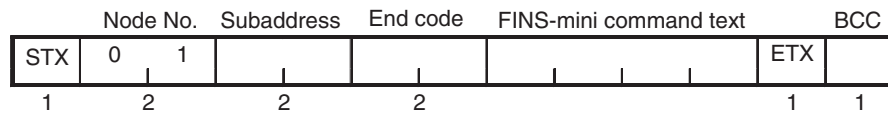

■ Response if Specified FINS Command was not Executed

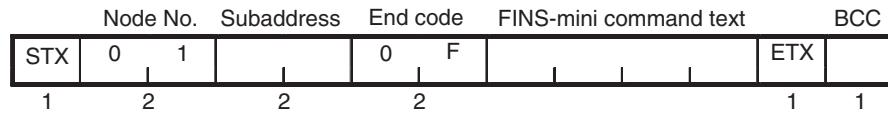

■ Response for Command Frame Error

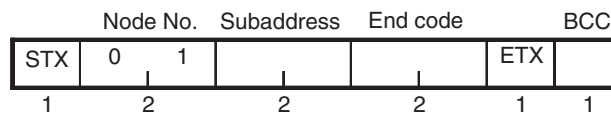

■ End Codes

End code	Name	Meaning	Error priority
00	Normal end	The command frame was processed normally without any of the following errors.	None
0F	FINS command error	The specified FINS command could not be executed. Refer to the response code for more details.	7
10	Parity error	A parity error was detected in the received data because the parity bit in the data did not match the parity setting.	1
11	Framing error	The stop bit was "0."	2
12	Overrun error	Attempted to write new data to the reception register when the reception register was full.	3
13	BCC error	The received BCC did not match the calculated BCC.	4
14	Format error	There was an illegal character in the FINS-mini frame (character other than ASCII 0 to 9 or A to F) or data other than the test data was returned in response to an Echoback Test. There were no SID and FINS-mini. There was no FINS-mini. The FINS-mini MRC and SRC were incorrect.	6
16	Subaddress error	The subaddress was invalid (unsupported). There were no subaddress, SID, and FINS-mini. The subaddress was shorter than 2 characters and there were no SID and FINS-mini.	5

- An end code is returned for each received command frame addressed to the local node.
- No response will be returned if the message is not complete through the ETX and BCC characters.
- The error priority indicates the priority of the error notification when there were two or more errors.

End Code Examples The following examples show some errors and corresponding end codes.

Missing Subaddress, SID, and FINS-mini

■ **Command**

Node No.		BCC	
STX	0 1	ETX	

■ **Response**

Node No.		Subaddress		End code		BCC	
STX	0 1	0 0	1 6	ETX			

The subaddress is 00 and the end code is 16 (subaddress error).

Subaddress Less than 2 Characters, Missing SID and FINS-mini

■ **Command**

Node No.		BCC	
STX	0 1 0	ETX	

The subaddress is missing one character.

■ **Response**

Node No.		Subaddress		End code		BCC	
STX	0 1	0 0	1 6	ETX			

The subaddress is 00 and the end code is 16 (subaddress error).

Subaddress Normal, Missing SID and FINS-mini

■ **Command**

Node No.		Subaddress		BCC	
STX	0 1	0 0	ETX		

■ **Response**

Node No.		Subaddress		End code		BCC	
STX	0 1	0 0	1 4	ETX			

The end code is 14 (format error).

Subaddress Invalid, Missing SID and FINS-mini

■ **Command**

Node No.		Subaddress		BCC	
STX	0 1	0 A	ETX		

■ **Response**

Node No.		Subaddress		End code		BCC	
STX	0 1	0 0	1 6	ETX			

The end code is 16 (subaddress error). The subaddress error code is returned because the subaddress was received and the subaddress error has a higher error priority than the format error.

Missing FINS-mini

■ Command

	Node No.		Subaddress		SID	BCC	
STX	0	1	0	0	0	ETX	

■ Response

	Node No.		Subaddress		End code		BCC	
STX	0	1	0	0	1	4	ETX	

The end code is 14 (format error).

Incomplete MRC and SRC Codes in FINS-mini

■ Command

	Node No.		Subaddress		SID	FINS-mini		BCC	
STX	0	1	0	0	0	MRC	0	ETX	

The SRC is missing one character.

■ Response

	Node No.		Subaddress		End code		BCC	
STX	0	1	0	0	1	4	ETX	

The end code is 14 (format error).

Incomplete Node Address

■ Command

	Node No.		BCC	
STX		ETX		

The node address is missing one character.

■ Response

None (There is no response because the return node address is unknown.)

Missing Subaddress, Invalid BCC

■ Command

	Node No.		BCC	
STX	0	1	ETX	Err

■ Response

	Node No.		Subaddress		End code		BCC	
STX	0	1	0	0	1	3	ETX	

The subaddress is 00 and the end code is 13 (BCC error).

Invalid Subaddress and BCC

■ **Command**

	Node No.		Subaddress		BCC	
STX	0	1	0	A	ETX	Err

■ **Response**

	Node No.		Subaddress		End code		BCC
STX	0	1	0	0	1	3	ETX

The end code is 13 (BCC error).

There was a subaddress error, but the BCC error has a higher error priority.

6-2-3 FINS-mini Structure

The FINS-mini command text and response text provides the contents of the command and response communications.

PDU Structure

The MRC (Main Request Code), SRC (Sub-Request Code), and any required data are transmitted in the command frame.

■ **Service Request PDU**

MRC	SRC	Data	
-----	-----	------	--

The MRC and SRC shown above, MRES (Main Response Code), SRES (Sub-Response Code), and the response data are transmitted in the response frame.

■ **Service Response PDU (Normal Response)**

MRC	SRC	MRES	SRES	Data	
-----	-----	------	------	------	--

If the specified FINS-mini command could not be executed, service response PDU will contain only the MRC/SRC and MRES/SRES.

■ **Service Response PDU (Specified FINS-mini Command Not Executed)**

MRC	SRC	MRES	SRES
-----	-----	------	------

The MRES and SRES become the response code when the command was not completed normally.

Type Code (Variable Type)

The following table shows the variable area type codes.

Variable type	R/W	Size	Contents
80	R	Word	Monitored values and alarm status
81	R/W	Word	Setting and checking set values

Addresses

Monitored Values

Do not operate or access branch outputs that do not exist in corresponding S8AS model.

■ Variable Type 80

Address	Name	Data range
0000	Present input voltage (V)	00A3 to 012C (16.3 to 30.0 V) If the lower limit is exceeded: 0000 If the upper limit is exceeded: 7FFF
0001	Total current (A)	0000 to 0190 (0.0 to 40.0 A) If the upper limit is exceeded: 7FFF
0002	Run time (kh)	0000 to 03E7 (0 to 999 kh) 1-kh increments
0003	Internal temperature (°C)	FFEC to 0064 (-20 to 100°C) If lower limit is exceeded: 8000 If upper limit is exceeded: 7FFF
0004	Remaining life (years)	0000 to 0096 (0.0 to 15.0 years)

Address	Name	Data range
0010	Present current, branch output 1	0000 to 00C8 (0.0 to 20.0 A)
0011	Present current, branch output 2	
0012	Present current, branch output 3	
0013	Present current, branch output 4	
0014	Present current, branch output 5	
0015	Present current, branch output 6	
0016	Present current, branch output 7	
0017	Present current, branch output 8	
0020	Peak output current, branch output 1	
0021	Peak output current, branch output 2	
0022	Peak output current, branch output 3	
0023	Peak output current, branch output 4	
0024	Peak output current, branch output 5	
0025	Peak output current, branch output 6	
0026	Peak output current, branch output 7	
0027	Peak output current, branch output 8	

Note If the upper limit of the displayable range is exceeded, the upper limit will be displayed. If the lower limit is exceeded, the lower limit will be displayed.

Alarm Status

The alarm status is used to read the controller status.

Alarm Cause

■ Variable Type 80

Address	Name	Data range
1000	Voltage when abnormal voltage tripping occurred	00A3 to 012C (16.3 to 30.0 V)
1002	Minimum voltage after undervoltage is detected	If the lower limit is exceeded: 0000 If the upper limit is exceeded: 7FFF

Note The run time and temperature are represented by variables 0002 and 0003, respectively.

Address	Name	Data range
1020	Current when abnormal current tripping occurred in branch output 1	0000 to 00C8 (0.0 to 20.0 A)
1021	Current when abnormal current tripping occurred in branch output 2	If the lower limit is exceeded: 0000
1022	Current when abnormal current tripping occurred in branch output 3	If the upper limit is exceeded: 7FFF
1023	Current when abnormal current tripping occurred in branch output 4	
1024	Current when abnormal current tripping occurred in branch output 5	
1025	Current when abnormal current tripping occurred in branch output 6	
1026	Current when abnormal current tripping occurred in branch output 7	
1027	Current when abnormal current tripping occurred in branch output 8	

Note If the upper limit of the displayable range is exceeded, the upper limit will be displayed. If the lower limit is exceeded, the lower limit will be displayed.

Parameters

■ Variable Type 81

Address	Name	Data range
0000	Undervoltage detection threshold (V)	00B4 to 0108 (18.0 to 26.4 V)
0002	Over-temperature output threshold (°C)	0019 to 005A (25 to 90°C)
0004	Protection level	0000 to 0002 (0: R/W allowed; 1: Limited R/W; 2: Limited read-only)
0005	Remaining life threshold	0000 to 0032 (0.0 to 5.0 years)
0006	Alarm reset setting	0000 to 0001 (0: Key, 1: Key + Power ON)
0007	External tripping input function setting	0000 to 0001 (0: Edge, 1: Level)

Address	Name	Data range
0010	Current tripping type for branch output 1	0000 or 0002 (0: Standard; 1: Instantaneous, 2: Extended)
0011	Current tripping type for branch output 2	
0012	Current tripping type for branch output 3	
0013	Current tripping type for branch output 4	
0014	Current tripping type for branch output 5	
0015	Current tripping type for branch output 6	
0016	Current tripping type for branch output 7	
0017	Current tripping type for branch output 8	

Address	Name	Data range
0020	Current tripping threshold for branch output 1	0005 to 0026 (0.5 to 3.8 A)
0021	Current tripping threshold for branch output 2	
0022	Current tripping threshold for branch output 3	
0023	Current tripping threshold for branch output 4	
0024	Current tripping threshold for branch output 5	
0025	Current tripping threshold for branch output 6	
0026	Current tripping threshold for branch output 7	
0027	Current tripping threshold for branch output 8	

Address	Name	Data range
0050	Startup sequence for branch output 1	0000 to 03E7 (0: Disabled, or 0.1 to 99.9 s)
0051	Startup sequence for branch output 2	
0052	Startup sequence for branch output 3	
0053	Startup sequence for branch output 4	
0054	Startup sequence for branch output 5	
0055	Startup sequence for branch output 6	
0056	Startup sequence for branch output 7	
0057	Startup sequence for branch output 8	

Address	Name	Data range
0060	Shutdown sequence for branch output 1	0000 to 03E7 (0: Disabled, or 0.1 to 99.9 s)
0061	Shutdown sequence for branch output 2	
0062	Shutdown sequence for branch output 3	
0063	Shutdown sequence for branch output 4	
0064	Shutdown sequence for branch output 5	
0065	Shutdown sequence for branch output 6	
0066	Shutdown sequence for branch output 7	
0067	Shutdown sequence for branch output 8	

Address	Name	Data range
0070	External tripping input cutoff for branch output 1	0000 or 0001 (0: Enabled; 1: Disabled)
0071	External tripping input cutoff for branch output 2	
0072	External tripping input cutoff for branch output 3	
0073	External tripping input cutoff for branch output 4	
0074	External tripping input cutoff for branch output 5	
0075	External tripping input cutoff for branch output 6	
0076	External tripping input cutoff for branch output 7	
0077	External tripping input cutoff for branch output 8	

Number of Elements

The number of elements is expressed in 2-byte hexadecimal. For the S8AS, the setting range for the number of elements is 0 to 56 (decimal format) so that all of the monitored values can be accessed together.

List of Services

MRC	SRC	Name of service	Processing
01	01	Read Variable Area	This service reads from variable areas.
01	02	Write Variable Area	This service writes to variable areas.
05	03	Read Controller Attributes	This service reads the model number and communications buffer size.
06	01	Read Controller Status	This service reads the operating status.
08	01	Echoback Test	This service performs an echoback test.
30	05	Operation Command	This service performs operations such as reset.

Note No commands (services) will be accepted and no responses will be returned when a memory error (RAM error) has occurred.

■ Response Codes

Response code	Error name	Cause	Error priority
1001	Command too long	The command is too long.	1
1002	Command too short	The command is too short.	2
1101	Area type error	The variable type is incorrect.	3
110B	Response too long	The number of elements is larger than "0038."	4
1100	Parameter error	The bit position is not "00."	5
0000	Normal completion	No error	None

Write Variable Area

This service writes data to a variable area.

■ Service Request PDU

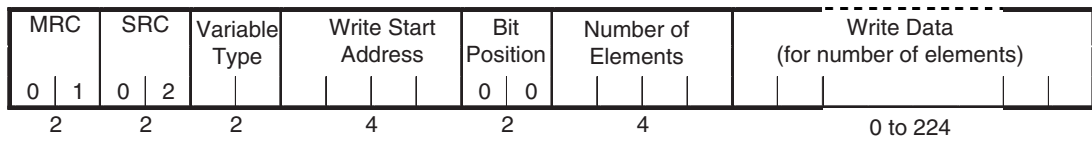

■ Service Response PDU

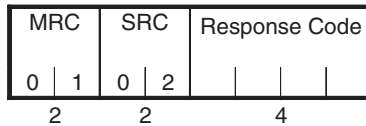

(1) Variable Type and Write Start Address

The definitions are different for each product.

(2) Bit Position

The S8AS does not support bit access. Fixed at "00."

(3) Number of Elements

Number of elements	Processing
0000	The write operation is not performed (does not append write data to the service request PDU) and processing ends in "normal completion."
0001 to 0038	The write operation is performed and processing ends in "normal completion" (hexadecimal display).

(4) Response Codes

Response code	Error name	Cause	Error priority
1002	Command too short	The command is too short.	1
1101	Area type error	The variable type is incorrect.	2
1003	Number of elements/data mismatch	The amount of data does not match the number of elements.	3
1100	Parameter error	The bit position is not "00." The write data is out of the setting range.	4
0000	Normal completion	No error	None

Note The "command too long" error does not occur with the Write Variable Area command.

If data is written up to the number of elements specified in the service request PDU, the error is processed as a number of elements/data mismatch error.

If the Write Start Address is outside of the variable area, the write operation will not be performed, but the processing will end in “normal completion.” The same thing will happen if the Write End Address is outside of the variable area. (See the following examples.)

- In this case, the number of elements (2) is within the specified range, but the Write Start Address setting is incorrect.



- In this case, the Write Start Address setting is correct, but the number of elements (3) exceeds the specified range.

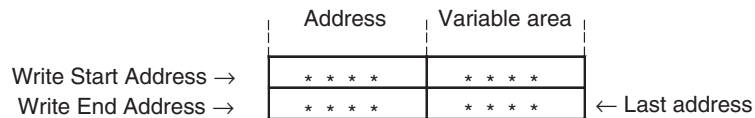

Note The system checks whether the number of elements is within the specified range when it performs the number of elements/data mismatch check. (See the following examples.)

Number of Elements/Data Mismatch

A number of elements/data mismatch error will occur in the following situations.

The data will not be written when this error occurs.

- In this case, the Write Start Address setting is correct and the amount of write data (2) is within the specified range, but the number of elements (4) exceeds the specified range.



- In this case, the number of elements (2) and the amount of write data (1) are both within the specified range, but the two values do not match.



When the number of elements is 2 and the amount of write data is 2, but second value (amount of write data) is outside of the setting range, the data will be written from the Start Write Address and a parameter error will occur when the system attempts to write the parameter that is outside of the setting range.

6-4 Read Controller Information

This service reads the Controller's model and version.

■ Service Request PDU

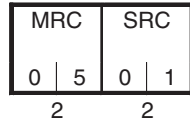

■ Service Response PDU

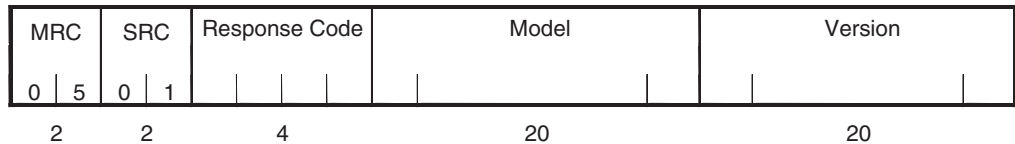

(1) Model

The S8AS's model number is returned in 20 bytes of ASCII data. If the data is less than 20 bytes long, the remaining bytes will be padded with spaces (20 hex).

The following table shows the model number format.

Model	Code (4 bytes)
Same in all models	S8AS
-	Code (1 byte)
-	-
Capacity	Code (3 bytes)
240 W	240
480 W	480
Number of branch outputs	Code (2 bytes)
1	01
2	02
:	:
8	08
Communications specification	Code (1 byte)
No communications, settings can be changed	All spaces
No communications, settings cannot be changed	N
Communications, settings can be changed	R
Remaining bytes	(9 bytes)
-	All spaces

(2) Version

The version number is returned in 20 bytes of ASCII data. If the data is less than 20 bytes long, the remaining bytes will be padded with spaces (20 hex).

Example: "V1.00"

The remaining 15 bytes are all spaces.

(3) Response Code

Response code	Error name	Cause	Error priority
1001	Command too long	The command is too long.	2
0000	Normal completion	No error	0

6-5 Read Controller Attributes

This service reads the model number and communications buffer size.

■ Service Request PDU

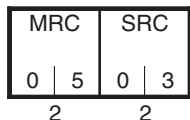

■ Service Response PDU



(1) Model

The first 10 bytes of ASCII data from the Read Controller Information command are returned. A specifications code follows the model number.

The following table shows the model number format.

Model	Code (4 bytes)
Same in all models	S8AS
–	Code (1 byte)
–	–
Capacity	Code (3 bytes)
240 W	240
480 W	480
Number of branch outputs	Code (2 bytes)
1	01
2	02
:	:
8	08
Communications specification	Code (1 byte)
No communications, settings can be changed	All spaces
No communications, settings cannot be changed	N
Communications, settings can be changed	R
Remaining bytes	(9 bytes)
–	All spaces

(2) Buffer Size

The communications buffer size is expressed in 2-byte hexadecimal and is converted to 4-byte ASCII before being displayed.

00F8 (Indicates 248 bytes.)

(3) Response Code

Response code	Error name	Cause	Error priority
1001	Command too long	The command is too long.	1
0000	Normal completion	No error	0

6-6 Read Controller Status

This service reads the operating status and error status.

■ Service Request PDU

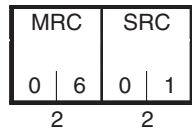

■ Service Response PDU

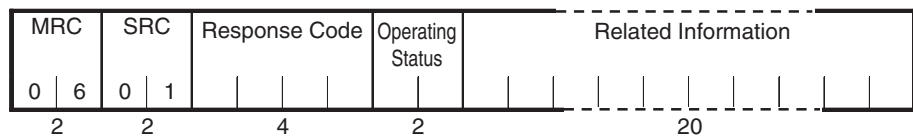

(1) Operating Status

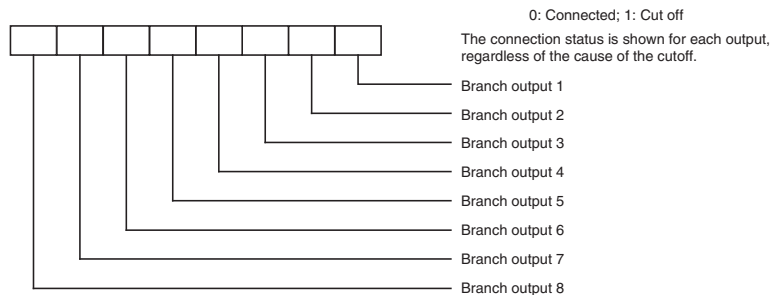

(2) Related Information

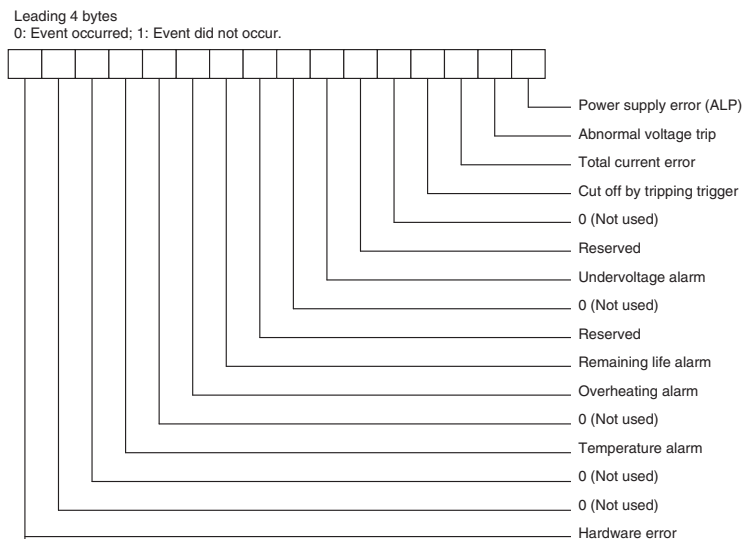

Next, 2 bytes for each of the 8 branch outputs
 0: Event did not occur.; 1: Event occurred.

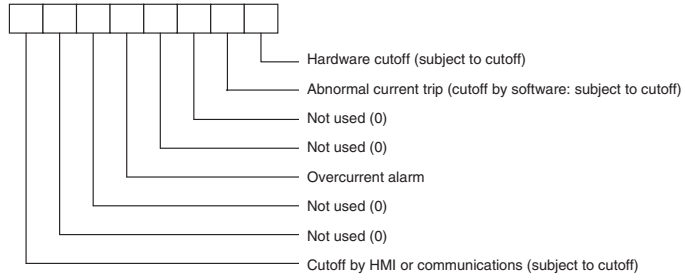

(3) Response Codes

Response code	Error name	Cause	Error priority
1001	Command too long	The command is too long.	2
0000	Normal completion	No error	0

6-7 Echoback Test

This service performs an echoback test.

■ Service Request PDU

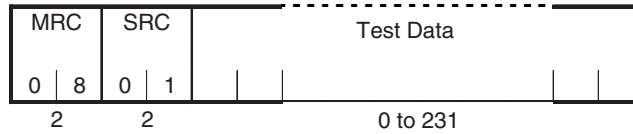

■ Service Response PDU

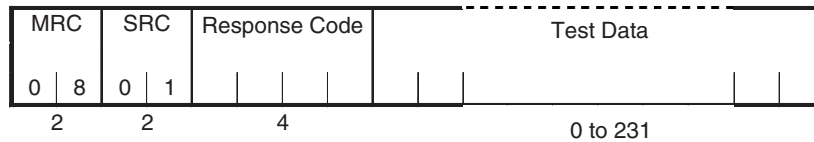

(1) Test Data

Set values for the test data within the ranges shown below, depending on the communications data length setting.

Data length	Processing
8 bits	ASCII data: 20 to 7E or A1 to FE
7 bits	ASCII data: 20 to 7E

(2) Response Codes

Response code	Error name	Cause	Error priority
1001	Command too long	The command is too long.	1
0000	Normal completion	No error	0

6-8 Operation Command

This service performs operation command processing.

■ Service Request PDU

MRC	SRC	Command Code	Related Info.
3 0	0 5		
2	2	2	2

■ Service Response PDU

MRC	SRC	Response Code
3 0	0 5	
2	2	4

(1) Command Codes and Related Information

Command code	Command content	Related Information
00	Immediately connect	Each bit corresponds to a branch output. (Multiple branch outputs can be specified.) 01: Branch output 1 10: Branch output 5 02: Branch output 2 20: Branch output 6 04: Branch output 3 40: Branch output 7 08: Branch output 4 80: Branch output 8
01	Immediately disconnect (Cut off)	Each bit corresponds to a branch output. (Multiple branch outputs can be specified.) 01: Branch output 1 10: Branch output 5 02: Branch output 2 20: Branch output 6 04: Branch output 3 40: Branch output 7 08: Branch output 4 80: Branch output 8
02	Startup	Always set to 00.
03	Shutdown	Always set to 00.
04	Reset switch	Always set to 00.
10	Clear peak output current	Each bit corresponds to a branch output. (Multiple branch outputs can be specified.) 01: Branch output 1 10: Branch output 5 02: Branch output 2 20: Branch output 6 04: Branch output 3 40: Branch output 7 08: Branch output 4 80: Branch output 8

- Note**
- (1) If a process is executed for all of the branch outputs and cannot be performed on one or more of them, it will still be performed on the other outputs. In this case, a normal response will be returned, so check the controller status display to confirm whether or not the outputs were actually connected or disconnected.
 - (2) After parameter initialization has been successfully completed, a normal response will be returned and then a software reset will be performed.
 - (3) The response to parameter initialization will be returned immediately even if a send wait time is specified.

(2) Response Codes

Response code	Error name	Cause	Error priority
1001	Command too long	The command is too long.	1
1002	Command too short	The command is too short.	2
1100	Parameter error	Command code and related information are wrong. Bit is ON for a non-existent branch output.	3
2203	Operation error	Processing could not be performed. (See note.)	4
0000	Normal completion	No error	0

Note Includes execution within 15 seconds after the last reset switch request.

6-9 Response Code List

Response code	Error name	Cause	Error priority
0000	Normal completion	No error	
0401	Unsupported command	The service function for the specified command is not supported.	1
1001	Command too long	The command is too long.	2
1002	Command too short	The command is too short.	3
1101	Area type error	The variable type is incorrect.	4
1003	Number of elements/data mismatch	The amount of data does not match the number of elements.	5
100B	Response too long	The response exceeds the communications buffer size.	6
1100	Parameter error	<ul style="list-style-type: none"> • The bit position is not 00. • A value that must be 00 was not set to 00. • Incorrect command code or related information in the operation command. • Incorrect operating mode or related information in a change operating mode command. • The write data is out of the setting range. 	7
3003	Read-only error	Attempted to write a read-only variable.	8
2203	Operation error	<ul style="list-style-type: none"> • The operation command could not be processed. • Not moved to system search mode. • A non-volatile memory error occurred. • Executed within 15 seconds after the last reset operation. 	9

6-10 ASCII List

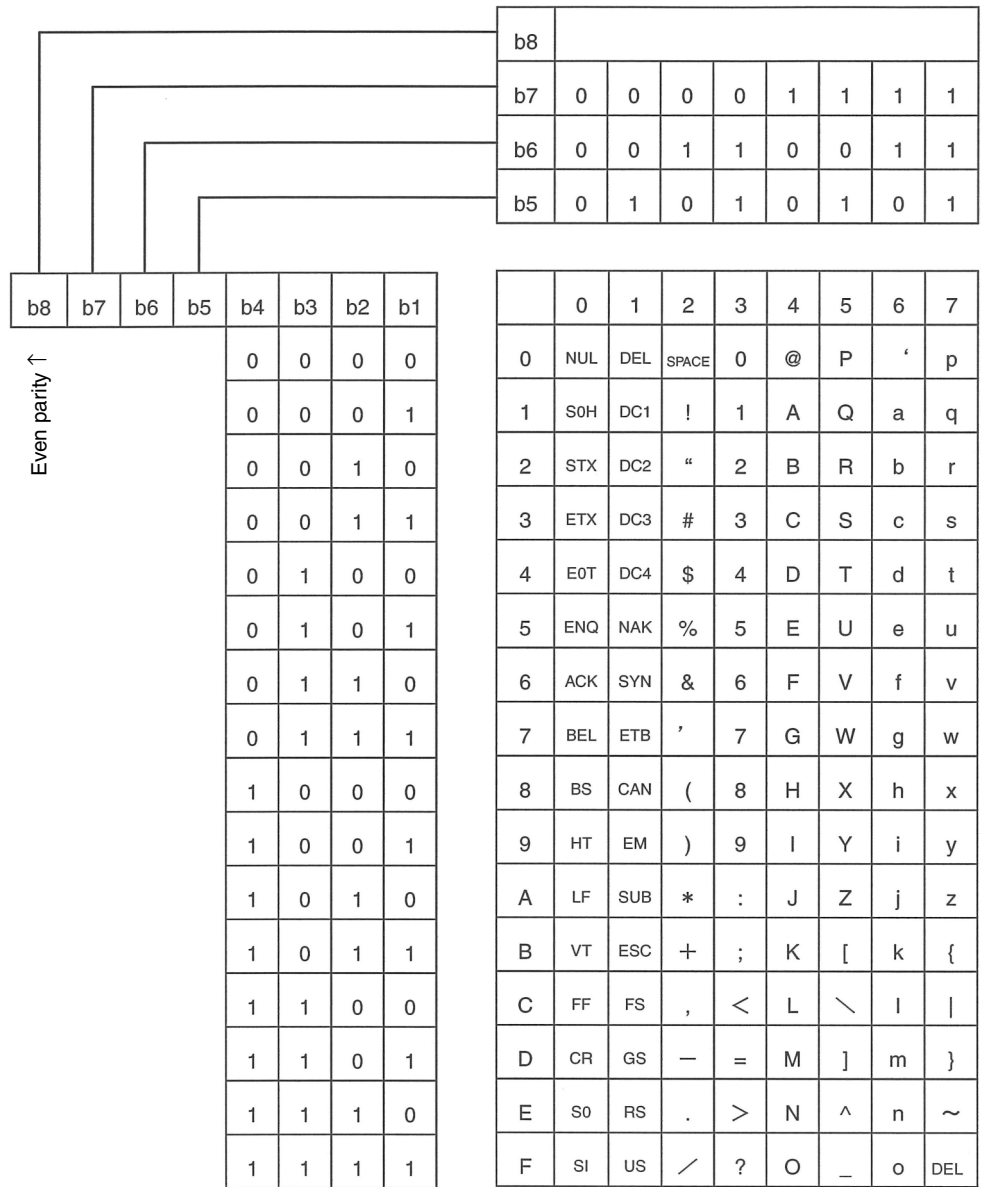

SECTION 7

Error Processing

This section explains how to troubleshoot errors that may occur when using the S8AS.

- 7-1 Troubleshooting 112
- 7-2 Seven-segment Error Codes 114
- 7-3 Clearing Errors 115

7-1 Troubleshooting

If the S8AS is not operating properly, check the items listed in the following table before requesting repairs. If the problem cannot be remedied, contact your OMRON sales representative.

	Observed problem	Possible cause	Remedy	Reference page
Installation	The S8AS was installed on a DIN Rail, but the bottom of the S8AS is not attached.	The S8AS's bottom latch is not mounted properly.	Check that the S8AS has been pressed until the bottom latch clicks.	45
Parameter settings	The desired parameter is not being displayed.	The setting is not allowed in the present protection level.	Change the protection level setting.	59
	The set value was changed, but the change wasn't accepted.	The new setting was not saved.	After pressing the Up and Down Keys to change the set value, press the ENT Key and verify that the setting flashes and the setting is saved.	61
	The branch outputs are not working.	All branch outputs are disconnected.	Switch to Test Mode and connect the desired branch outputs.	80
	Communications cannot be established after changing the communications parameters.	Communications parameters are not updated until the power is turned OFF and ON again.	Turn the power OFF, then ON again.	54
Equipment setup	The display is flashing "ON" in Test Mode, but power is not being supplied by the outputs.	A flashing "ON" display indicates that the S8AS is waiting to turn ON the outputs.	If the ENT Key is pressed, the output will be connected and power will be supplied. When power is being supplied, "OFF" will flash on the display to indicate the S8AS is waiting to turn OFF the output.	80
	When the output is connected in Test Mode, it is cut off immediately and can't be connected again.	Check whether the status indicator is lit red. The current may be higher than the abnormal current tripping threshold.	Check for problems such as output wiring and load connection problems. If no problems are found, press the Reset Key.	78, 115
Operation	The displayed temperature is clearly different from the ambient temperature.	The S8AS detects the S8AS's internal temperature, which can be 10 to 20°C higher than the ambient temperature.	If the over-temperature output is being used to control a fan or cooling equipment, set the over-temperature output threshold based on the graph on page 37.	35, 65
	An alarm was output and the cause of the alarm was eliminated, but the alarm display was not cleared.	The S8AS doesn't disregard temporary errors, so the display and output are maintained even after the cause of the alarm is cleared.	The alarm can be cleared by pressing the Reset Key.	115

	Observed problem	Possible cause	Remedy	Reference page
Operation	The peak output current is not displayed and the display shows “- - .”	The current may have exceeded the measurable range.	Clear the peak output current in Run Mode.	84
	The peak output current is higher than the abnormal current tripping threshold, but the output has not been cut off.	The S8AS provides a startup delay so that inrush currents do not cause tripping at startup. The output will thus not be cut off at startup, but the maximum current will be recorded as the peak output current.	Clear the peak output current using the operation provided. Thereafter, the peak output current during normal operation will be recorded.	84
	The output was not designed for a current that high, but the output is cut off as soon as power is supplied.	The abnormal current tripping type may be set to “instantaneous.” With instantaneous detection, an abnormal current is detected very quickly and the output may be cut off due to excessive current during equipment operation.	Either change the abnormal current tripping type from instantaneous to standard or increase the current tripping threshold.	30 62
		There may be a large number of devices connected to the output. The more devices that are connected, the higher the operating current.	Connect the devices to different branch outputs and use the S8AS's startup sequence to offset the connections to the devices.	37, 66
Branch output cutoff	The connection cannot be reset immediately after it is cut off (RST) is displayed.	To protect the S8AS's internal circuits, at least 15 seconds must pass before a cut-off output can be reset.	Press the Reset Key for at least 3 s. “RST” should be displayed and the cut-off output can be reset after 15 seconds have passed since the cutoff.	30, 115
	The output was reset, but it was immediately cut off again.	The original cause of the cut-off may not have been eliminated. After resetting the error, a large current may have flowed again.	Eliminate the problem that caused the cutoff and press the Reset Key.	115
Saving or maintenance	The overheating alarm (A23/HOT alternating display) cannot be cleared.	If the S8AS stays overheated for more than 3 hours, the overheat alarm cannot be cleared because the life span of the Power Supply can no longer be calculated correctly.	If the overheating alarm is displayed, be sure it is cleared within 3 hours.	10
	All of the outputs were connected when the parameters were initialized.	Initializing parameters returns all settings to their default values. All outputs are connected by default.	The S8AS will be in Run Mode after initializing the parameters. Change to Test Mode and reset the required branch outputs to ON (connected) or OFF (disconnected).	58

7-2 Seven-segment Error Codes

Error Display List

Seven-segment display	Error code	Meaning	Probable cause and remedy	
<i>ErP</i>	ERP	Memory error on power supply side	<p>These are S8AS system errors.</p> <p>When one of these error codes is displayed, check the system configuration and clear the error, and then turn the power supply OFF and ON again.</p> <p>If the error code persists, contact your OMRON representative regarding the error.</p>	
.	---	S8AS hardware error		
<i>RLP</i>	ALP	Power supply voltage error		
<i>E98</i>	E98	RAM error		
<i>E97</i>	E97	EEPROM read error		
<i>E96</i>	E96	EEPROM write error		
<i>E95</i>	E95	Internal communications error		
<i>E94</i>	E94	Short circuit failure		
<i>E00</i>	E00	EEPROM initialization error		
<i>E01</i>	E01	EEPROM error		
<i>E02</i>	E02	Model error		
<i>E03</i>	E03	Factory default detection mode		
<i>E10</i>	E10	Data other than communications data is corrupted.	There is an error in the parameter settings.	<p>Press the Mode Key to switch to the parameter initialization display. After initializing the parameters, set them again.</p> <p>This error is treated as a system error for the S8AS-24006N/48008N.</p>
<i>R10</i>	A10	Abnormal voltage tripping	The power supply voltage exceeded 28.8 V.	Check the power supply voltage.
<i>R11</i>	A11	Abnormal current tripping	The branch output's current exceeded the current tripping threshold.	Check whether the connected device is correct and check whether the set value is appropriate.
<i>R12</i>	A12	Total current tripping	All branch outputs were cutoff because the total current and the power-ON time exceeded the abnormal total current tripping conditions.	Check whether the connected devices are suitable and operating within the total current limit.
<i>R21</i>	A21	Undervoltage alarm	The output voltage dropped below the undervoltage detection threshold.	Check the power supply voltage and the set value.
<i>R23</i>	A23	Maintenance forecast monitor output	The replacement time calculated by the S8AS is lower than the notification time.	Indicates that the replacement time is approaching.
<i>R23/Hōt</i>	A23/HOT	Overheating alarm	The S8AS is overheated	Take steps to reduce the internal temperature.
<i>R30</i>	A30	Over-temperature output	The S8AS's internal temperature exceeded the over-temperature output threshold.	<p>Check for a high ambient temperature and check the setting of the over-temperature output threshold.</p> <p>Take steps to reduce the temperature in the control panel.</p>

- When two or more errors occur simultaneously, the higher priority error (higher in the table above) will be displayed.

- The A11 and A22 errors may occur simultaneously in two or more branch outputs. In this case, the corresponding branch output indicators will not be lit.

7-3 Clearing Errors

When an error has occurred, the error code will be displayed on the seven-segment display. Eliminate the cause of the error and clear the error.

It is possible to clear an error immediately after it occurs, but once an error has been reset, another reset operation cannot be performed for at least 15 seconds to protect the S8AS's internal circuits.

Errors can be cleared (reset) by pressing the Reset Key (RST) on the S8AS.

Clearing Errors with the Reset Key

The Reset Key (RST) can be pressed to clear an error and supply power to an output that was cut off.

The following example shows the display when branch output 1 of 240-W model was cut off because an abnormal current was detected.

If an error occurs, first determine the cause of the error and eliminate the cause.

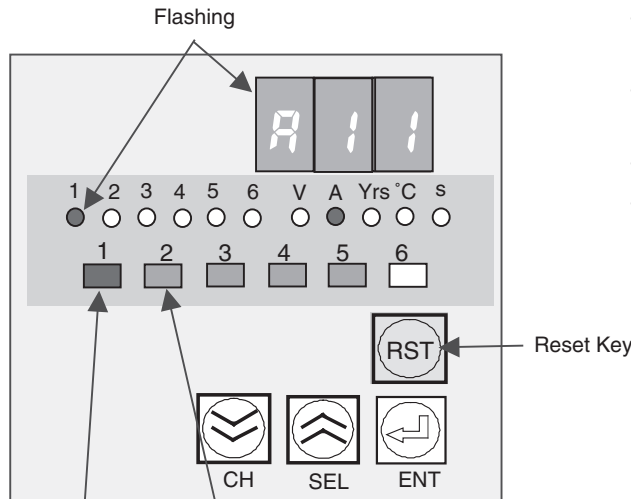

Lit red when output is cut off.

Lit green when output is connected.

- The seven-segment display alternately shows error code A11 and the measured current.
- The branch output 1 indicator and unit indicator (A) will flash along with the measured current.
- Status Indicator 1 will be lit red.
- When the status indicator is flashing red, it indicates that the output has been cut off by hardware tripping due to the operation of the redundant protective circuit.

Clearing the Error

Press the Reset Key to clear the error. Power will be supplied at the output again.

Regardless of whether the Power Supply is in Run Mode, Setting Mode, or Test Mode, errors caused by events such as overcurrent can be cleared by eliminating the cause of the error and then pressing the Reset Key (RST). Error codes will be displayed on the seven-segment display only in Run Mode. They will not be displayed in other modes, but they can be displayed by switching to Run Mode.

Errors cannot be cleared in the following situations because the reset function will be disabled.

- From the parameter display screen in Setting Mode
- From the Yes/No display when clearing the peak current
- From the parameter initialization Yes/No display

- From the protection level setting display
- When an E** error has occurred

Note When the Reset Key is pressed, “ \overline{r} 5 \overline{t} ” (RST) will be displayed on the seven-segment display.

Clearing Errors by Turning Power OFF and ON

Branch outputs that have been cut off can be reconnected by turning the input power OFF and then ON again. This function can be enabled or disabled by setting the Reset Method Setting (RST) parameter. The default setting allows errors to be reset by turning the power supply OFF and ON again. For other methods, refer to the section on the Reset Key.

Identifying and Correcting the Cause of the Error

When an error code is displayed on the seven-segment display, determine whether an error actually occurred or there is a problem with the parameter setting.

Correcting Abnormal Current Tripping (A11) Errors

When error code A11 (abnormal current tripping) and the current are displayed alternately on the seven-segment display, there are two possible causes. Check whether the load connected to the output is too large or the current setting is too low.

- If there are too many loads connected, split up the loads.
- If the current setting is too low, increase the setting.
- If the overcurrent is occurring momentarily, check the abnormal current tripping type setting on page 62. The detection of short-lived abnormal currents can be prevented by changing the setting from instantaneous detection (detection after 10 ms) to standard detection (detection after 80 ms).

Over-temperature Output (A30) Displayed

When error code A30 (over-temperature) and the temperature are displayed alternately on the seven-segment display, there are two possible causes. Check whether the S8AS's internal temperature is too high or the setting of the over-temperature output threshold is too low.

Maintenance Forecast Monitor Output (A23) Displayed

When error code A23 (maintenance forecast monitor output) is displayed on the seven-segment display, it indicates that the replacement time calculated by the S8AS has fallen below the set value. The number of years left before replacement is required will be displayed in half-year increments. Prepare to replace the Power Supply.

Appendix A

Glossary

The following table lists terms related to the S8AS Smart Power Supply and a brief description of the terms. For details, see the referenced page.

Term	Meaning	Page
abnormal current tripping	If a branch output's current exceeds the set value, that output is cut off. The tripping threshold can be set between 0.5 and 3.8 A. The seven-segment display will show error code A11 and the Alarm Output (TRP) photoswitch output turns OFF when the output is cut off.	4, 30, 50, 61
abnormal voltage tripping	If the output voltage exceeds 28.8 VDC, all of the branch outputs will be cut off immediately. The seven-segment display will show error code A10 and the Alarm Output (TRP) photoswitch output turns OFF when the outputs are cut off. It is not necessary to set parameters for this function.	29, 50
alarm tripping output	The branch output is cutoff and Alarm Output (TRP) photoswitch output turns OFF when the S8AS detects an abnormal current or voltage.	6, 50
branch output	A branch output is one of the S8AS's 24-VDC outputs. The 240-W models have 6 branch outputs, and the 480-W models have 8 branch outputs.	3, 16, 48
current fuse	When a branch output could not be cut off by the semiconductor relay, a current fuse will blow to protect the circuit. If the fuse blows, that branch output will become unusable.	34
cut off	A branch output will be cut off if the S8AS detects an abnormal current or voltage or if an external tripping signal is received.	11
DIN Rail	Used to install the S8AS.	45
external tripping input	Branch outputs can be forcibly cut off with an input to the External Tripping Input (TRG terminal). The shutdown sequence function will operate in this case.	6, 39, 50, 69
instantaneous detection (alarm type and tripping type)	Each branch output's tripping current and abnormal current can be detected with standard detection (tripping within 100 ms), instantaneous detection (tripping within 20 ms), or extended detection (tripping within 1,000 ms). With instantaneous detection, the output will be cut off within 20 ms if the current is higher than the tripping threshold continuously for 10 ms or longer.	4, 30, 62
LFE	An external output terminal. LFE is an abbreviation for "life." The photoswitch output turns OFF when the maintenance forecast monitor function is activated.	12, 17, 50
LOW	An external output terminal. The photoswitch output turns OFF if the undervoltage detection output is activated.	12, 17, 50
extended detection (alarm type and tripping type)	Each branch output's tripping current and abnormal current can be detected with standard detection (tripping within 100 ms), instantaneous detection (tripping within 20 ms) or extended detection (tripping within 1,000 ms). With extended detection, the output will be cut off within 20 ms if the current is higher than the tripping threshold continuously for 980 ms or longer.	4, 30, 62
operating mode	There are three operating modes in the S8AS: Run Mode, Setting Mode, and Test Mode. The operating mode cannot be changed to Setting Mode for models that do not permit setting changes (S8AS-24006N/48008N).	7, 84
over-temperature output	The S8AS has a built-in temperature sensor that monitors the internal temperature. The Over-temperature Output (TMP) photoswitch output will turn OFF if the internal temperature exceeds the set value.	6, 35, 50, 65
parameter initialization	Parameter Initialization is used to return all parameters to their default settings.	58
peak output current	The peak output current for each branch outputs can be read in Run Mode. The peak output currents can be cleared using S8AS key operations or from the Support Tool.	84
protection level	The protection level can be set to one of three levels to restrict read/write access to the parameters. This function can be used to prevent parameters from being changed or deleted inadvertently. The default protection level is level 1.	6, 59

Term	Meaning	Page
reset method	The reset method describes how to reset an error status after an error cut off has occurred and the cause has been removed. You can use the Reset Key method (KEY) or the Reset Key and power restart method (ALL).	10, 76
maintenance forecast monitor function	The status of the electrolytic capacitor is measured from the power-ON time and internal temperature of the Power Supply and the user is notified of the replacement time. The maintenance forecast monitor output can be set for 0.0 to 5.0 years (approximate). The seven-segment display will show the error code A23 and the external output terminal maintenance forecast monitor output (LFE) will turn ON. (Photoswitch output OFF.)	5, 34, 50, 64
Run Mode	This is the normal operation mode for S8AS. The branch outputs are connected and the output voltages, output currents, internal temperature, and power-ON time are monitored continuously.	7, 82
semiconductor relay	Branch outputs are not cut off mechanically in the S8AS. Each branch output is connected/cut off by a high-capacity FET (transistor).	3
Setting Mode	This operating mode is used to set the parameters.	7, 60
shutdown sequence	If branch outputs are cut off by the external tripping input (TRG), the shutdown sequence can set a separate delay for cutting off each branch output.	6, 38, 67
standard detection (alarm type and tripping type)	Each branch output's tripping current and abnormal current can be detected with standard detection (tripping within 100 ms), instantaneous detection (tripping within 20 ms), or extended detection (tripping within 1,000 ms). With standard detection, the output will be cut off or the alarm will be output within 80 ms if the current is higher than the tripping threshold continuously for 20 ms or longer.	4, 30, 62
startup delay	Tripping operation can be disabled for 40 ms when the power is turned ON in order to prevent the inrush current from being detected as an abnormal current and cutting off operation. The peak output current value will still be updated during the startup delay.	34
startup sequence	The startup sequence can set a separate delay for the connection of power to each branch output when the power is turned ON. This function can reduce the inrush current and voltage drop that occur when the power is turned ON.	6, 37, 66
Test Mode	Each branch output can be set to ON or OFF (connected or disconnected). Also, the operation of the startup sequence and shutdown sequence can be verified.	7, 78
thermal fuse	If current is not cut off by the semiconductor relay alone, the built-in thermal fuse will operate to protect the circuit. After a fuse has operated, the branch output cannot be used any longer.	6, 34
TMP	An external output terminal. TMP is an abbreviation for the over-temperature output terminal. The photoswitch output turns OFF if the S8AS internal temperature exceeds the over-temperature output threshold.	12, 17, 50
total output current	The total output current is the sum of all the branch output currents. There is a maximum limit to the total current in addition to the maximum limit of each branch output.	xvi, 33
TRG(+)/(-)	The external tripping input terminals. TRG is an abbreviation for "trigger" and represents the external tripping input. It is used to cutoff branch outputs from an external source. The shutdown sequence applies to the cutoff process.	12, 17, 50
TRP	An external output terminal. TRP is an abbreviation for the tripping alarm output terminal. The photoswitch output turns OFF if there is an abnormal current or abnormal voltage tripping event.	12, 17, 50
tripping type	A branch output's tripping current can be detected with standard detection, instantaneous detection, or extended detection. (This is not possible for the S8AS-24006N/48008N.)	62
undervoltage detection output	If the output voltage is below the set value, the undervoltage detection output (LOW) photoswitch output turns OFF. The detection threshold can be set between 18.0 and 26.4 VDC.	12, 29, 63

Seven-segment Display

Symbol	Seven-segment display	Meaning	Page
AS	RS	When the power supply is turned ON, this display is shown for approximately 3 s during the initialization process. When initialization has finished, the display will change automatically.	8
BIT	b ₇ t	BIT is an abbreviation for “stop bits.” Sets the number of stop bits for RS-485 communications.	73
BPS	bPS	Sets the baud rate for RS-485 communications.	71
C-T	C-t	C-T is an abbreviation for “cut off type.” The abnormal current tripping type can be selected from Standard (USU), Instantaneous (INS), or Extended (LNG)	62
C-V	C-v	C-V is an abbreviation for “cutoff value.” Sets the abnormal current tripping threshold. Setting range: 0.5 to 3.8 A.	60, 61
DWS	dWS	DWS is an abbreviation for “shutdown sequence.” Sets the shutdown sequence time for each branch output. Setting range: 0.0 to 99.9s.	67
EGE	EGE	EGE is an abbreviation for “edge.” It is one of the branch output tripping methods using the external tripping input (TRG). All branch outputs are cut off according to the shutdown sequence when the input is turned ON.	40, 69
FUL	FUL	FUL is an abbreviation for “full.” It is displayed when the remaining lifetime of the maintenance forecast monitor is more than 10 years.	34
HLF	HLF	HLF is an abbreviation for “half.” It is displayed when the remaining lifetime of the maintenance forecast monitor is more than 5 years.	34
INI	INI	INI is an abbreviation for “initial.” It is an option in the Mode Selection Menu and is displayed when the protection level is 0. If the ENT Key is pressed, all S8AS parameters will return to default values.	57
INS	INS	INS is an abbreviation for “instantaneous.” It represents instantaneous detection. It is the abnormal current cutoff type that trips within 20 ms.	62
LEN	LEN	LEN is an abbreviation for “length.” Sets the data length for RS-485 communications.	72
LFE	LFE	LFE is an abbreviation for “life.” Sets the number of years for the maintenance forecast monitor function to output an alarm. (0.5 to 5.0 years.)	64
LNG	LNG	LNG is an abbreviation for “date long.” It represents extended detection. It is the abnormal current cut off type that trips within 1,000 ms.	62
LVL	LVL	LVL is an abbreviation for “level.” It is one of the branch output tripping methods using the external tripping input (TRG). All branch outputs are cut off according to the shutdown sequence when the input is turned ON or turned OFF.	40, 69
PRT	Prt	PRT is an abbreviation of “protect.” It is an option in the Mode Selection Menu that must be selected to change the protection level.	57, 59
PTY	PTY	PTY is an abbreviation for “parity bit.” Sets the parity for RS-485 communications.	74
RST	rSt	RST is an abbreviation of “reset.” Press the Reset Key after an abnormal tripping event. The RST indicator will flash while the error is cleared.	76

Symbol	Seven-segment display	Meaning	Page
RUN		Run is an option in the Mode Selection Menu which is selected when entering Run Mode.	57
SET		SET is an abbreviation for “setting.” It is an option in the Mode Selection Menu that is selected when entering Setting Mode.	57, 60
SWT		SWT is an abbreviation for “send waiting time.” Sets the communications waiting time for RS-485 communications.	75
TMP		TMP is an abbreviation for “temperature.” The Over-temperature Output (TMP) photoswitch output will turn OFF if the temperature exceeds the set value.	50, 65
TGS		Trigger-Sense Sets the tripping input detection method for TRG. There are two types of detection methods, EGE and LVL.	69
TRG		TRG is an abbreviation of “trigger.” Determines for each branch output whether it can be cut off using an external input signal.	17, 50, 68
TST		TST is an abbreviation for “test.” It is an option in the Mode Selection Menu that is selected when entering Test Mode.	57
UNO		UNO is an abbreviation for “unit number” Sets the unit number for RS-485 communications.	70
UPS		UPS is an abbreviation of “startup sequence.” It sets the connection delay time for each branch output. Setting range: 0.0 to 99.9s	66
USU		USU is an abbreviation for “usually.” It is a cutoff type (C-T) for abnormal current tripping. It trips within 100 ms.	62
V-U		V-U is an abbreviation for “voltage under.” It sets the undervoltage detection threshold value. If the output voltage falls below this set value, the seven-segment display shows the error code A21 and the undervoltage detection output (LOW) photoswitch output turns OFF.	63

Appendix B

List of Operations

Mode Selection Menu Operations

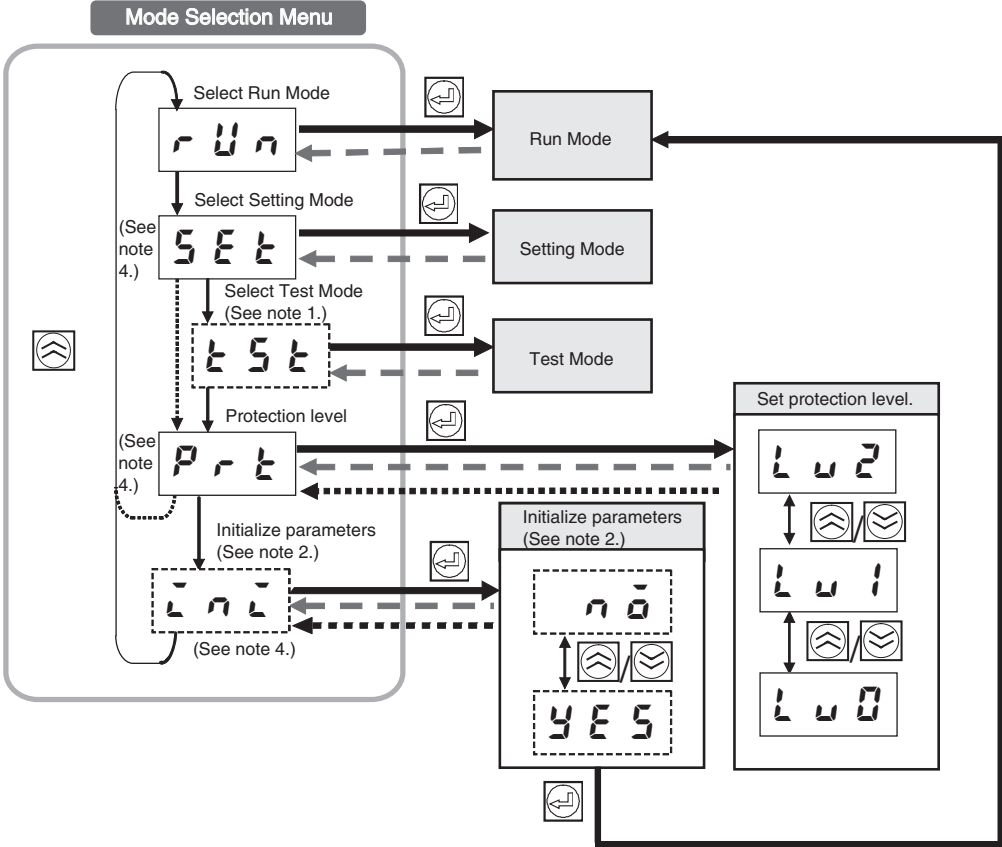

- Note 1:** The "TST" display does not appear in protection level 2.
- Note 2:** The "INI" display does not appear in protection level 1 or 2.
- Note 3:** The display will also change if the Enter Key is not pressed to save the setting and no other key is pressed for 5 s or longer.
- Note 4:** Not displayed for the S8AS-24006N/48008N.

+ (Press for 3 s.)
 No keys pressed for 3 s.

Setting Mode

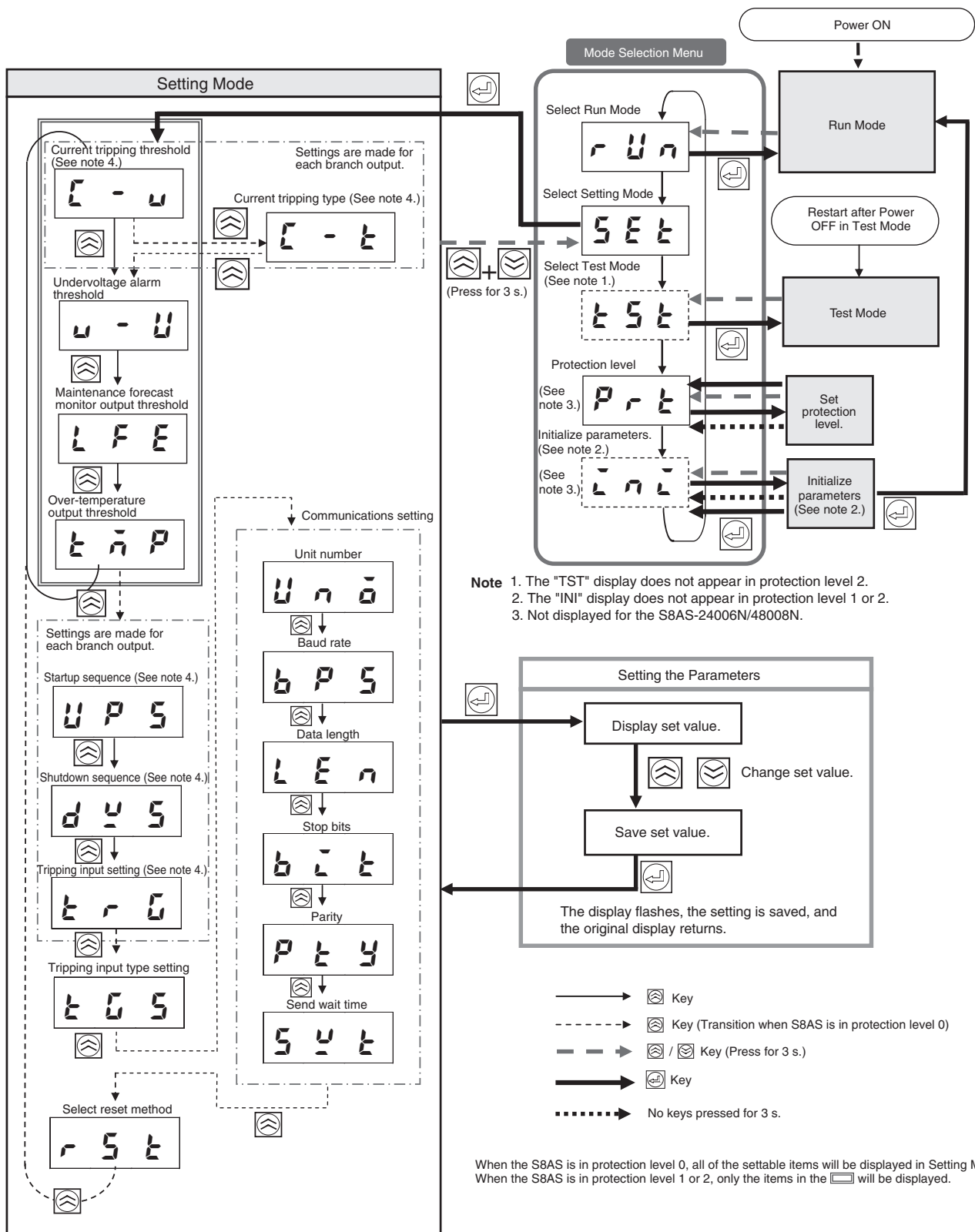

4. The desired branch output number can be selected using the Key.

Test Mode

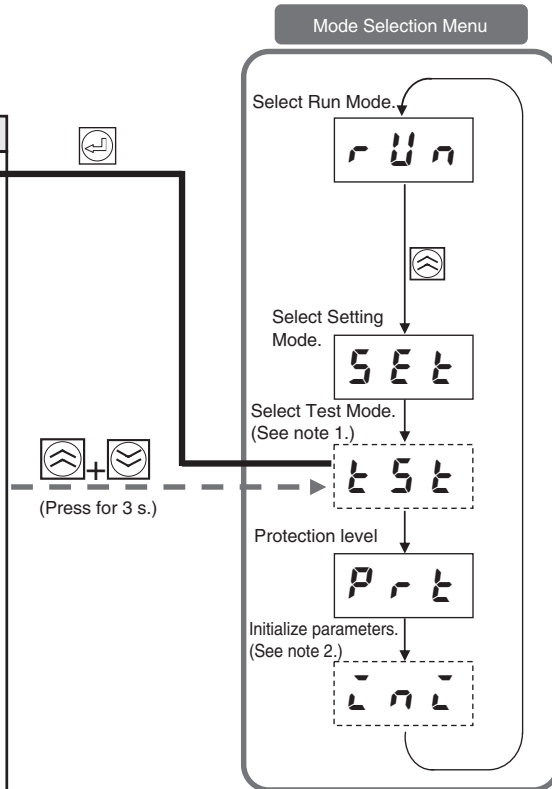
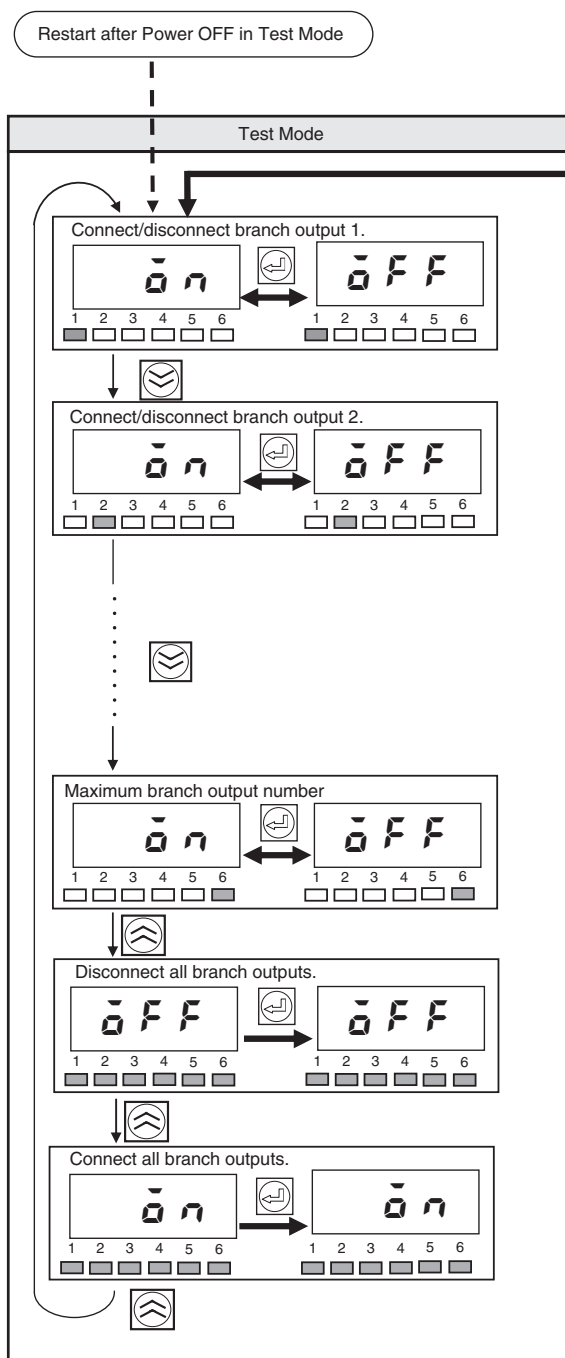

- Note 1.** The "TST" display does not appear in protection level 2.
- Note 2.** The "INI" display does not appear in protection level 1 or 2.

The ON/OFF display and the branch output number will flash in Test Mode.

- When "ON" is flashing, the S8AS is waiting to connect the output.
Press the [Key] to connect the output.
When "OFF" is flashing, the S8AS is waiting to disconnect the output.
Press the [Key] to disconnect the output.
- Connecting/Disconnecting All Branch Outputs
Press the [Key] Key when "ON" is flashing to connect all outputs and check the operation of the startup sequence.
Press the [Key] Key when "OFF" is flashing to disconnect all outputs and check the operation of the shutdown sequence.

Run Mode

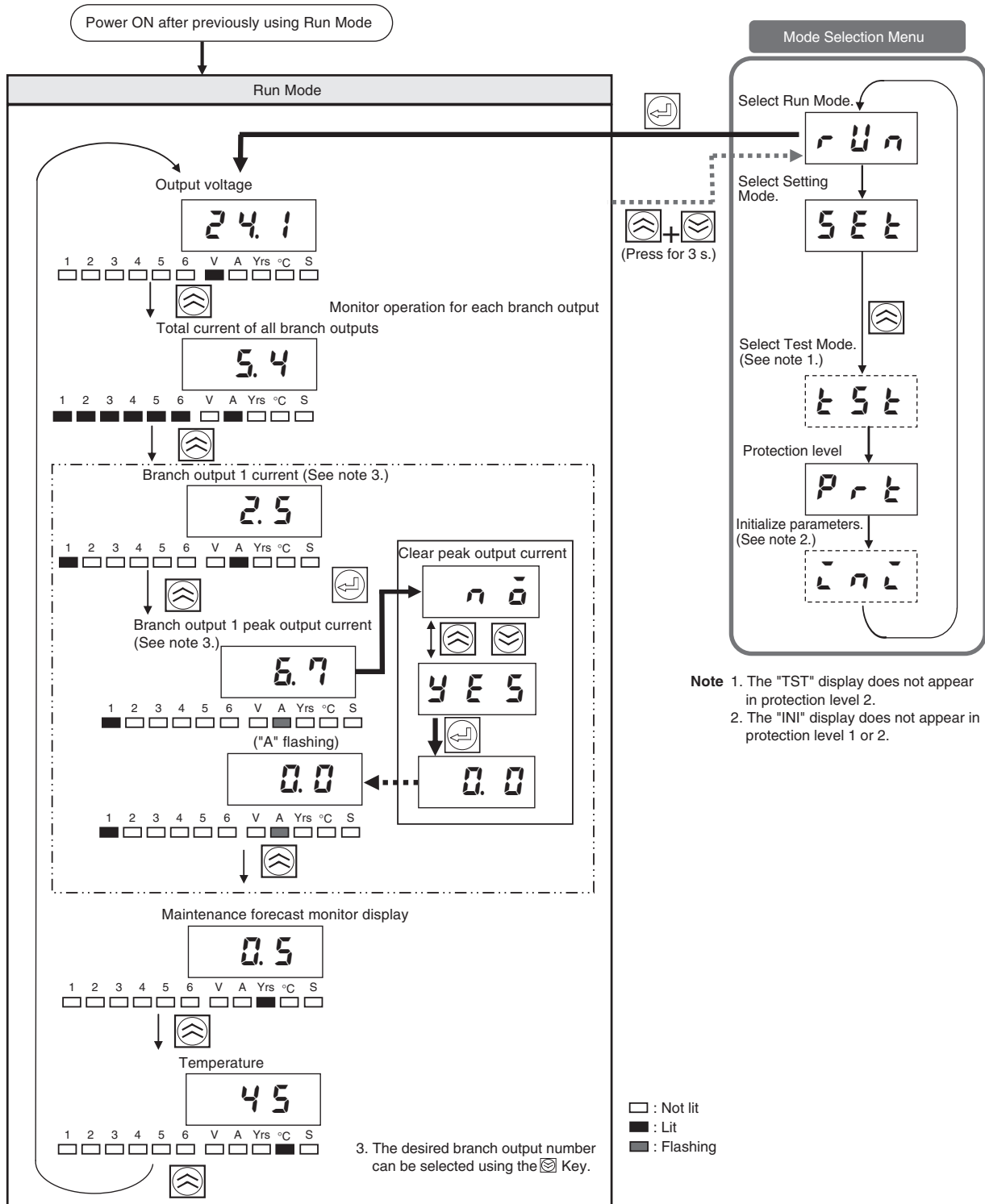

Revision History

A manual revision code appears as a suffix to the catalog number on the front cover of the manual.

Cat. No. Z269-E1-07

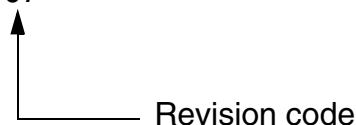

The following table outlines the changes made to the manual during each revision. Page numbers refer to the previous version.

Revision code	Date	Revised content
01	December 2007	Original production
02	March 2008	<p>Page xiv: Changed first sentence of <i>Derating Curve</i> section.</p> <p>Page 4: Changed “abnormal tripping alarms” to “tripping alarms.”</p> <p>Page 8: Changed information on abnormal current tripping.</p> <p>Page 19: Changed information under first table regarding status indicators.</p> <p>Page 22: Removed restriction for abnormal total current tripping</p> <p>Page 23: Changed output current display specification.</p> <p>Page 24: Changed temperature display specification.</p> <p>Pages 25 and 28: Changed specifications for safety standards.</p> <p>Page 26: Added information regarding total abnormal current tripping to table, and changed output current display specification.</p> <p>Page 27: Changed temperature display specification.</p> <p>Page 52: Added information regarding wiring the external outputs and external tripping input. Information changed in table. Added “delay relay” callout to figure.</p> <p>Page 54: Added reference to last paragraph. Added “clamp filter” callout to figure.</p> <p>Page 56: Changed information on reset input settings.</p> <p>Page 62: Changed Up Key graphic to Enter Key graphic.</p> <p>Page 65: Changed Down Key graphic to Up Key graphic.</p> <p>Page 71: Changed information in note 4.</p> <p>Page 80: Changed information in the fourth paragraph.</p> <p>Page 97: Added row to first table and removed “At 240 W” from <i>Data Range</i> Column in second table.</p> <p>Page 114: Deleted 7th row from table.</p>
03	June 2008	Corrections for changes to S8AS-24006N/48008N specifications.
04	January 2011	<p>Page 17: Changed second cell in right column of table.</p> <p>Page 18: Corrected “input” to “output” in second cell in right column of bottom table.</p> <p>Page 29: Changed first sentence in <i>Operation</i>.</p> <p>Page 63: Changed note.</p> <p>Page 88: Changed model number at top of page.</p> <p>Page 114: Corrected “input” to “output” in the table row for A21.</p> <p>Page 118: Corrected “input” to “output” in the description of “undervoltage detection output.”</p>
05	September 2013	<p>Page 49: Added information to note in <i>Wiring the Branch Output Connector</i>.</p> <p>Page 50: Added note to Output Common regarding the polarity in <i>Wiring the External Outputs and External Tripping Input</i>.</p>
06	February 2018	Corrected mistakes.
07	September 2022	Added information on <i>Safety Precautions</i> .

Revision History

OMRON Corporation Industrial Automation Company

Kyoto, JAPAN

Contact : www.ia.omron.com

Regional Headquarters

OMRON EUROPE B.V.

Wegalaan 67-69, 2132 JD Hoofddorp

The Netherlands

Tel: (31) 2356-81-300 Fax: (31) 2356-81-388

OMRON ASIA PACIFIC PTE. LTD.

438B Alexandra Road, #08-01/02 Alexandra
Technopark, Singapore 119968

Tel: (65) 6835-3011 Fax: (65) 6835-2711

OMRON ELECTRONICS LLC

2895 Greenspoint Parkway, Suite 200

Hoffman Estates, IL 60169 U.S.A.

Tel: (1) 847-843-7900 Fax: (1) 847-843-7787

OMRON (CHINA) CO., LTD.

Room 2211, Bank of China Tower,
200 Yin Cheng Zhong Road,

PuDong New Area, Shanghai, 200120, China

Tel: (86) 21-5037-2222 Fax: (86) 21-5037-2200

Authorized Distributor:

©OMRON Corporation 2007-2022 All Rights Reserved.
In the interest of product improvement,
specifications are subject to change without notice.

Cat. No. Z269-E1-07

0922