

DeviceNet Safety
NE1A Series:
NE1A-SCPU01(-V1)
NE1A-SCPU02
NE1A-SCPU01-EIP
NE1A-SCPU02-EIP

Safety Network Controller

OPERATION MANUAL

OMRON

**NE1A Series Safety Network Controller:
NE1A-SCPU01(-V1)/SCPU02
NE1A-SCPU01-EIP/SCPU02-EIP**

Operation Manual

Revised October 2022

Notice:

OMRON products are manufactured for use according to proper procedures by a qualified operator and only for the purposes described in this manual.

The following conventions are used to indicate and classify precautions in this manual. Always heed the information provided with them. Failure to heed precautions can result in injury to people or damage to property.



WARNING

Indicates a potentially hazardous situation which, if not avoided, will result in minor or moderate injury, or may result in serious injury or death. Additionally, there may be significant property damage.



Indicates general prohibitions for which there is no specific symbol.



Indicates general mandatory actions for which there is no specific symbol.

OMRON Product References

All OMRON products are capitalized in this manual. The word “Unit” is also capitalized when it refers to an OMRON product, regardless of whether or not it appears in the proper name of the product.

The abbreviation “PLC” means Programmable Controller. “PC” is used, however, in some Programming Device displays to mean Programmable Controller.

Visual Aids

The following headings appear in the left column of the manual to help you locate different types of information.

IMPORTANT Indicates important information on what to do or not to do to prevent failure to operation, malfunction, or undesirable effects on product performance.

Note Indicates information of particular interest for efficient and convenient operation of the product.

1,2,3... 1. Indicates lists of one sort or another, such as procedures, checklists, etc.

Trademarks and Copyrights

CIP, EtherNet/IP, DeviceNet, and DeviceNet Safety are registered trademarks of the ODVA.

Other product names and company names in this manual are trademarks or registered trademarks of their respective companies.

© **OMRON, 2005**

All rights reserved. No part of this publication may be reproduced, stored in a retrieval system, or transmitted, in any form, or by any means, mechanical, electronic, photocopying, recording, or otherwise, without the prior written permission of OMRON.

No patent liability is assumed with respect to the use of the information contained herein. Moreover, because OMRON is constantly striving to improve its high-quality products, the information contained in this manual is subject to change without notice. Every precaution has been taken in the preparation of this manual. Nevertheless, OMRON assumes no responsibility for errors or omissions. Neither is any liability assumed for damages resulting from the use of the information contained in this publication.

TABLE OF CONTENTS

PRECAUTIONS	xvii
1 Intended Audience	xviii
2 General Precautions	xviii
3 Safety Precautions	xx
4 Precautions for Safe Use	xxii
5 Additional Precautions According to ANSI/ISA 12.12.01	xxiv
6 Regulations and Standards	xxiv
7 Unit Versions of NE1A-series Controllers	xxiv
SECTION 1	
Overview of the NE1A-series Safety Network Controllers.	1
1-1 About NE1A-series Safety Network Controllers	2
1-2 System Configuration	8
1-3 System Setup Procedure	18
SECTION 2	
Specifications and Nomenclature	21
2-1 Nomenclature and Functions	22
2-2 Specifications	36
SECTION 3	
Installation and Wiring	41
3-1 Installation	42
3-2 Wiring	51
SECTION 4	
DeviceNet Communications Functions	69
4-1 Initial Setting	70
4-2 Network Status Indication	73
4-3 Remote I/O Allocations	74
4-4 Safety Master Function	88
4-5 Safety Slave Function	94
4-6 Standard Slave Function	98
SECTION 5	
Ethernet Communications	103
5-1 Connecting to Ethernet	104
5-2 EtherNet/IP Communications	108
5-3 UDP/IP Message Communications	112

TABLE OF CONTENTS

SECTION 6

Explicit Message Communications 115

6-1	Receiving Explicit Messages	116
6-2	Sending Explicit Messages	124

SECTION 7

I/O Control 127

7-1	Common Functions	128
7-2	Safety Inputs	135
7-3	Test Outputs	140
7-4	Safety Outputs	141

SECTION 8

Programming 145

8-1	Outline of Programming	146
8-2	Function Block Overview	149
8-3	Function Block Editing	150
8-4	Command Reference: Logic Functions	155
8-5	Command Reference: Function Blocks	166

SECTION 9

Other Functions 215

9-1	Configuration Lock	216
9-2	Reset	217
9-3	Access Control with Password	219

SECTION 10

Operating Modes and Power Supply Interruptions 221

10-1	NE1A-series Controller Operating Modes	222
10-2	Behavior for Power Supply Interruptions	227

SECTION 11

Remote I/O Communications Performance and Local I/O Response Time 229

11-1	Outline	230
11-2	Operational Flow and Cycle Time	231
11-3	Startup Time	232
11-4	I/O Refresh Cycle Time and Network Reaction Time	234
11-5	Reaction Time	237

TABLE OF CONTENTS

SECTION 12

Troubleshooting	243
12-1 Error Categories.....	244
12-2 Confirmation of Error State.....	245
12-3 Indicator/Display Status and Corrective Actions for Errors	246
12-4 Error History	253
12-5 Errors When Downloading	260
12-6 Errors When Resetting.....	263
12-7 Errors When Changing Modes	264
12-8 Connection Status Tables.....	265

SECTION 13

Maintenance and Inspection	271
13-1 Inspection.....	272
13-2 NE1A-series Controller Replacement	273

Appendices	275
-------------------------	------------

Glossary	345
-----------------------	------------

Index	349
--------------------	------------

Revision History	353
-------------------------------	------------

About this Manual:

This manual describes the installation and operation of the NE1A-series Safety Network Controllers.

Please read this manual carefully and be sure you understand the information provided before attempting to install or operate the NE1A-series Controller. Be sure to read the precautions provided in the following section.

Definition of NE1A-series Controllers

In this manual, “NE1A-series Controllers” refers to the following Controllers

CPU Units without EtherNet/IP

NE1A-SCPU01(-V1)

NE1A-SCPU02

CPU Units with EtherNet/IP

NE1A-SCPU01-EIP

NE1A-SCPU02-EIP

Related Manuals

The following manuals provide information on the DeviceNet and DeviceNet Safety.

DeviceNet Safety NE1A Series Safety Network Controller Operation Manual (this manual) (Z906)

This manual describes the specifications, functions, and usage of the NE1A-SCPU01 and NE1A-SCPU02.

DeviceNet Safety System Configuration Manual (Z905)

This manual explains how to configure the DeviceNet Safety system using the Network Configurator.

DeviceNet Safety Safety I/O Terminal Operation Manual (Z904)

This manual describes the DST1-series Slave models, specifications, functions, and application methods in detail.

EtherNet/IP-DeviceNet Router Operation Manual (Z912)

This manual describes the specifications, functions, and application methods of the EtherNet/IP-DeviceNet Router in detail.

DeviceNet Operation Manual (W267)

This manual describes the construction and connection of a DeviceNet network. It provides detailed information on the installation and specifications of cables, connectors, and other peripheral equipment used in the network, and on the supply of communications power. Obtain this manual and gain a firm understanding of its contents before using a DeviceNet system.



WARNING

Failure to read and understand the information provided in this manual may result in personal injury or death, damage to the product, or product failure. Please read each section in its entirety and be sure you understand the information provided in the section and related sections before attempting any of the procedures or operations given.

Read and Understand this Manual

Please read and understand this manual before using the product. Please consult your OMRON representative if you have any questions or comments.

Terms and Conditions Agreement

Warranty, Limitations of Liability

Warranties

● Exclusive Warranty

Omron's exclusive warranty is that the Products will be free from defects in materials and workmanship for a period of twelve months from the date of sale by Omron (or such other period expressed in writing by Omron). Omron disclaims all other warranties, express or implied.

● Limitations

OMRON MAKES NO WARRANTY OR REPRESENTATION, EXPRESS OR IMPLIED, ABOUT NON-INFRINGEMENT, MERCHANTABILITY OR FITNESS FOR A PARTICULAR PURPOSE OF THE PRODUCTS. BUYER ACKNOWLEDGES THAT IT ALONE HAS DETERMINED THAT THE PRODUCTS WILL SUITABLY MEET THE REQUIREMENTS OF THEIR INTENDED USE.

Omron further disclaims all warranties and responsibility of any type for claims or expenses based on infringement by the Products or otherwise of any intellectual property right.

● Buyer Remedy

Omron's sole obligation hereunder shall be, at Omron's election, to (i) replace (in the form originally shipped with Buyer responsible for labor charges for removal or replacement thereof) the non-complying Product, (ii) repair the non-complying Product, or (iii) repay or credit Buyer an amount equal to the purchase price of the non-complying Product; provided that in no event shall Omron be responsible for warranty, repair, indemnity or any other claims or expenses regarding the Products unless Omron's analysis confirms that the Products were properly handled, stored, installed and maintained and not subject to contamination, abuse, misuse or inappropriate modification. Return of any Products by Buyer must be approved in writing by Omron before shipment. Omron Companies shall not be liable for the suitability or unsuitability or the results from the use of Products in combination with any electrical or electronic components, circuits, system assemblies or any other materials or substances or environments. Any advice, recommendations or information given orally or in writing, are not to be construed as an amendment or addition to the above warranty.

See <http://www.omron.com/global/> or contact your Omron representative for published information.

Limitation on Liability; Etc

OMRON COMPANIES SHALL NOT BE LIABLE FOR SPECIAL, INDIRECT, INCIDENTAL, OR CONSEQUENTIAL DAMAGES, LOSS OF PROFITS OR PRODUCTION OR COMMERCIAL LOSS IN ANY WAY CONNECTED WITH THE PRODUCTS, WHETHER SUCH CLAIM IS BASED IN CONTRACT, WARRANTY, NEGLIGENCE OR STRICT LIABILITY.

Further, in no event shall liability of Omron Companies exceed the individual price of the Product on which liability is asserted.

Application Considerations

Suitability of Use

Omron Companies shall not be responsible for conformity with any standards, codes or regulations which apply to the combination of the Product in the Buyer's application or use of the Product. At Buyer's request, Omron will provide applicable third party certification documents identifying ratings and limitations of use which apply to the Product. This information by itself is not sufficient for a complete determination of the suitability of the Product in combination with the end product, machine, system, or other application or use. Buyer shall be solely responsible for determining appropriateness of the particular Product with respect to Buyer's application, product or system. Buyer shall take application responsibility in all cases.

NEVER USE THE PRODUCT FOR AN APPLICATION INVOLVING SERIOUS RISK TO LIFE OR PROPERTY OR IN LARGE QUANTITIES WITHOUT ENSURING THAT THE SYSTEM AS A WHOLE HAS BEEN DESIGNED TO ADDRESS THE RISKS, AND THAT THE OMRON PRODUCT(S) IS PROPERLY RATED AND INSTALLED FOR THE INTENDED USE WITHIN THE OVERALL EQUIPMENT OR SYSTEM.

Programmable Products

Omron Companies shall not be responsible for the user's programming of a programmable Product, or any consequence thereof.

Disclaimers

Performance Data

Data presented in Omron Company websites, catalogs and other materials is provided as a guide for the user in determining suitability and does not constitute a warranty. It may represent the result of Omron's test conditions, and the user must correlate it to actual application requirements. Actual performance is subject to the Omron's Warranty and Limitations of Liability.

Change in Specifications

Product specifications and accessories may be changed at any time based on improvements and other reasons. It is our practice to change part numbers when published ratings or features are changed, or when significant construction changes are made. However, some specifications of the Product may be changed without any notice. When in doubt, special part numbers may be assigned to fix or establish key specifications for your application. Please consult with your Omron's representative at any time to confirm actual specifications of purchased Product.

Errors and Omissions

Information presented by Omron Companies has been checked and is believed to be accurate; however, no responsibility is assumed for clerical, typographical or proofreading errors or omissions.

PRECAUTIONS

1	Intended Audience	xviii
2	General Precautions	xviii
3	Safety Precautions.	xx
4	Precautions for Safe Use.	xxii
5	Additional Precautions According to ANSI/ISA 12.12.01	xxiv
6	Regulations and Standards	xxiv
7	Unit Versions of NE1A-series Controllers	xxiv

1 Intended Audience

This manual is intended for the following personnel, who must have knowledge of electrical systems (an electrical engineer or the equivalent).

- Personnel in charge of introducing FA and safety systems into production facilities
- Personnel in charge of designing FA and safety systems
- Personnel in charge of managing FA facilities
- Personnel who have the qualifications, authority, and obligation to provide safety during each of the following product phases: mechanical design, installation, operation, maintenance, and disposal

2 General Precautions

The user must operate the product according to the performance specifications described in the operation manuals.

Before using the product under conditions which are not described in the manual or applying the product to nuclear control systems, railroad systems, aviation systems, vehicles, combustion systems, medical equipment, amusement machines, safety equipment, and other systems, machines, and equipment that may have a serious influence on lives and property if used improperly, consult your OMRON representative.

Make sure that the ratings and performance characteristics of the product are sufficient for the systems, machines, and equipment, and be sure to provide the systems, machines, and equipment with double safety mechanisms.

This manual provides information for programming and operating the Unit. Be sure to read this manual before attempting to use the Unit and keep this manual close at hand for reference during operation.

 **WARNING** It is extremely important that a PLC and all PLC Units be used for the specified purpose and under the specified conditions, especially in applications that can directly or indirectly affect human life. You must consult with your OMRON representative before applying a PLC System to the above-mentioned applications

 **WARNING** This is the Operation Manual for the NE1A-series Safety Network Controllers. Heed the following items during system construction to ensure that safety-related components are configured in a manner that allows the system functions to sufficiently operate.

• Risk Assessment

The proper use of the safety device described in this Operation Manual as it relates to installation conditions and mechanical performance and functions is a prerequisite for its use. When selecting or using this safety device, risk assessment must be conducted with the aim of identifying potential danger factors in equipment or facilities in which the safety device is to be applied, during the development stage of the equipment or facilities. Suitable safety devices must be selected under the guidance of a sufficient risk assessment system. An insufficient risk assessment system may lead to the selection of unsuitable safety devices.

- Typical related international standards: ISO 14121, Safety of Machinery -- Principles of Risk Assessment

- **Safety Measures**

When using this safety device to build systems containing safety-related components for equipment or facilities, the system must be designed with the full understanding of and conformance to international standards, such as those listed below, and/or standards in related industries.

- Typical related international standards: ISO/DIS 12100, Safety of Machinery -- Basic Concepts and General Principles for Design IEC 61508, Safety Standard for Safety Instrumented Systems (Functional Safety of Electrical/Electronic/Programmable Electronic Safety-related Systems)

- **Role of Safety Device**

This safety device is provided with safety functions and mechanisms as stipulated in relevant standards, but suitable designs must be used to allow these functions and mechanisms to operate properly inside system constructions containing safety-related components. Build systems that enable these functions and mechanisms to perform properly, based on a full understanding of their operation.

- Typical related international standards: ISO 14119, Safety of Machinery -- Interlocking Devices Associated with Guards -- Principles of Design and Selection

- **Installation of Safety Device**

The construction and installation of systems with safety-related components for equipment or facilities must be performed by technicians who have received suitable training.

- Typical related international standards: ISO/DIS 12100, Safety of Machinery -- Basic Concepts and General Principles for Design IEC 61508, Safety Standard for Safety Instrumented Systems (Functional Safety of Electrical/Electronic/Programmable Electronic Safety-related Systems)

- **Complying with Laws and Regulations**

This safety device conforms to the relevant regulations and standards, but make sure that it is used in compliance with local regulations and standards for the equipment or facilities in which it is applied.

- Typical related international standards: IEC 60204, Safety of Machinery -- Electrical Equipment of Machines

- **Observing Precautions for Use**













When putting the selected safety device to actual use, heed the specifications and precautions in this Operation Manual and those in the Instruction Manual that comes with the product. Using the product in a manner that deviates from these specifications and precautions will lead to unexpected failures in equipment or devices, and to damages that result from such failures, due to insufficient operating functions in safety-related components.

- **Moving or Transferring Devices or Equipment**

When moving or transferring devices or equipment, be sure to include this Operation Manual to ensure that the person to whom the device or equipment is being moved or transferred will be able to operate it properly.

- Typical related international standards: ISO/DIS 12100 ISO, Safety of Machinery -- Basic Concepts and General Principles for Design IEC 61508, Safety Standard for Safety Instrumented Systems (Functional Safety of Electrical/ Electronic/ Programmable Electronic Safety-related Systems)







3 Safety Precautions



 WARNING	
<p> Serious injury may possibly occur due to loss of required safety functions. Do not use the NE1A-series Controller's test outputs as safety outputs. </p>	
<p> Serious injury may possibly occur due to loss of required safety functions. Do not use non-safety data as safety signals. </p>	
<p> Serious injury may possibly occur due to loss of required safety functions. Do not use DeviceNet standard I/O data, EtherNet/IP standard I/O data, UDP/IP message data, or explicit message data as safety signals. </p>	
<p> Serious injury may possibly occur due to loss of required safety functions. Do not use indicators or 7-segment display on the NE1A-series Controller for safety operations. </p>	
<p> Serious injury may possibly occur due to breakdown of safety outputs or test outputs. Do not connect loads beyond the rated value to the safety outputs and test outputs. </p>	
<p> Serious injury may possibly occur due to loss of required safety functions. Wire the NE1A-series Controller properly so that the 24-VDC line does NOT touch the outputs accidentally or unintentionally. </p>	
<p> Serious injury may possibly occur due to loss of required safety functions. Ground the 0-V line of the power supply for external output devices so that the devices do NOT turn ON when the safety output line or the test output line is grounded. </p>	
<p> Serious injury may possibly occur due to loss of required safety functions. Clear previous configuration data before connecting the devices to the network. </p>	
<p> Serious injury may possibly occur due to loss of required safety functions. Set suitable node addresses and a suitable baud rate before connecting the devices to the network. </p>	
<p> Serious injury may possibly occur due to loss of required safety functions. Perform user testing and confirm that all of the device configuration data and operation is correct before starting system operation. </p>	
<p> Serious injury may possibly occur due to loss of required safety functions. When replacing a device, configure the replacement device suitably and confirm that it operate correctly. </p>	
<p> Serious injury may possibly occur due to loss of required safety functions. Use appropriate components or devices according to the requirements given in the following table. </p>	

Control device	Requirements
Emergency stop switch	Use approved devices with a direct opening mechanism compliant with IEC/EN 60947-5-1.
Door interlocking switch or limit switch	Use approved devices with a direct opening mechanism compliant with IEC/EN 60947-5-1 and capable of switching micro-loads of 4 mA at 24 VDC.
Safety sensor	Use approved devices compliant with the relevant product standards, regulations, and rules in the country where they are used.
Relay with forcibly guided contacts	Use approved devices with forcibly guided contacts compliant with IEC 61810-3. For feedback signals, use devices with contacts capable of switching micro-loads of 4 mA at 24 VDC.

Control device	Requirements
Contactors	Use contactors with a forcibly guided mechanism and monitor the auxiliary NC contact to detect contactor failures. For feedback signals, use devices with contacts capable of switching micro-loads of 4 mA at 24 VDC.
Other devices	Evaluate whether devices used are appropriate to satisfy the requirements of the safety category level.

Security Measures

 WARNING	
<p>Anti-virus protection</p> <p>Install the latest commercial-quality antivirus software on the computer connected to the control system and maintain to keep the software up-to-date.</p>	
<p>Security measures to prevent unauthorized access</p> <p>Take the following measures to prevent unauthorized access to our products.</p> <ul style="list-style-type: none"> • Install physical controls so that only authorized personnel can access control systems and equipment. • Reduce connections to control systems and equipment via networks to prevent access from untrusted devices. • Install firewalls to shut down unused communications ports and limit communications hosts and isolate control systems and equipment from the IT network. • Use a virtual private network (VPN) for remote access to control systems and equipment. • Adopt multifactor authentication to devices with remote access to control systems and equipment. • Set strong passwords and change them frequently. • Scan virus to ensure safety of USB drives or other external storages before connecting them to control systems and equipment. 	
<p>Data input and output protection</p> <p>Validate backups and ranges to cope with unintentional modification of input/output data to control systems and equipment.</p> <ul style="list-style-type: none"> • Checking the scope of data • Checking validity of backups and preparing data for restore in case of falsification and abnormalities • Safety design, such as emergency shutdown and fail-soft operation in case of data tampering and abnormalities 	
<p>Data recovery</p> <p>Backup data and keep the data up-to-date periodically to prepare for data loss.</p>	
<p>When using an intranet environment through a global address, connecting to an unauthorized terminal such as a SCADA, HMI or to an unauthorized server may result in network security issues such as spoofing and tampering. You must take sufficient measures such as restricting access to the terminal, using a terminal equipped with a secure function, and locking the installation area by yourself.</p>	

 WARNING	
When constructing an intranet, communication failure may occur due to cable disconnection or the influence of unauthorized network equipment. Take adequate measures, such as restricting physical access to network devices, by means such as locking the installation area.	
When using a device equipped with the SD Memory Card function, there is a security risk that a third party may acquire, alter, or replace the files and data in the removable media by removing the removable media or unmounting the removable media. Please take sufficient measures, such as restricting physical access to the Controller or taking appropriate management measures for removable media, by means of locking the installation area, entrance management, etc., by yourself.	

4 Precautions for Safe Use

■ Handling with Care

Do not drop the NE1A-series Controller or subject it to excessive vibration or mechanical shock. The NE1A-series Controller may be damaged and may not function properly.

■ Installation and Storage Environment

Do not use or store the NE1A-series Controller in any of the following locations:

- Locations subject to direct sunlight
- Locations subject to temperatures or humidity outside the range specified in the specifications
- Locations subject to condensation as the result of severe changes in temperature
- Locations subject to corrosive or flammable gases
- Locations subject to dust (especially iron dust) or salts
- Locations subject to water, oil, or chemicals
- Locations subject to shock or vibration

Take appropriate and sufficient measures when installing systems in the following locations. Inappropriate and insufficient measures may result in malfunction.

- Locations subject to static electricity or other forms of noise
- Locations subject to strong electromagnetic fields
- Locations subject to possible exposure to radioactivity
- Locations close to power supplies

■ Installation and Mounting

- Use the NE1A-series Controller within an enclosure with IP54 protection or higher according to IEC/EN 60529.
- Use DIN rail (TH35-7.5/TH35-15 according to IEC 60715) to install the NE1A-series Controller into the control panel. Mount the NE1A-series Controller to the DIN rail using PFP-M End Plates (not included with the NE1A-series Controller) to prevent it falling off the DIN rail because of vibration.

- Space must be provided around the NE1A-series Controller, at least 5 mm from its side and at least 50 mm from its top and bottom surfaces, for ventilation and wiring.

■ Installation and Wiring

- Use the following to wire external I/O devices to the NE1A-series Controller.

Solid wire	0.2 to 2.5 mm ² (AWG 24 to AWG 12)
Stranded (flexible) wire	0.34 to 1.5 mm ² (AWG 22 to AWG 16)

- Disconnect the NE1A-series Controller from the power supply before starting wiring. Devices connected to the NE1A-series Controller may operate unexpectedly.
- Properly apply the specified voltage to the NE1A-series Controller inputs. Applying an inappropriate DC voltage or any AC voltage will cause the NE1A-series Controller to fail.
- Be sure to separate the communications cables and I/O cables from near high-voltage/high-current lines.
- Be cautious not to get your fingers caught when attaching connectors to the plugs on the NE1A-series Controller.
- Tighten the DeviceNet connector screws correctly (0.25 to 0.3 N·m).
- Incorrect wiring may lead to loss of safety functions. Wire conductors correctly and verify the operation of the NE1A-series Controller before using the system in which the NE1A-series Controller is incorporated.
- After wiring is completed, be sure to remove label for wire clipping prevention on the NE1A-series Controller to enable heat to escape or proper cooling.

■ Power Supply Selection

Use a DC power supply satisfying the following requirements.

- The secondary circuits of the DC power supply must be isolated from the primary circuit by double insulation or reinforced insulation.
- The DC power supply must satisfy the requirements for class 2 circuits or limited voltage/current circuits given in UL 508.
- The output hold time must be 20 ms or longer.

■ Periodic Inspections and Maintenance

- Disconnect the NE1A-series Controller from the power supply before replacing the Controller. Devices connected to the NE1A-series Controller may operate unexpectedly.
- Do not disassemble, repair, or modify the NE1A-series Controller. Doing so may lead to loss of safety functions.

■ Disposal

- Be cautious not to injure yourself when dismantling the NE1A-series Controller.

5 Additional Precautions According to ANSI/ISA 12.12.01

The NE1A-series Controller is suitable for use in Class I, Div. 2, Group A, B, C, D or Non-Hazardous Location Only.

WARNING - Explosion Hazard - Substitution of Components May Impair Suitability For Class I, Div. 2.

WARNING - Explosion Hazard - Do Not Disconnect Equipment Unless Power Has Been Switched OFF or the Area Is Known To Be Non-Hazardous.

WARNING - Explosion Hazard - Do Not Disconnect USB Connector Unless Power Has Been Switched OFF or the Area Is Known To Be Non-Hazardous.

6 Regulations and Standards

The following certifications have been obtained for the NE1A-SCPU01, NE1A-SCPU01-V1, NE1A-SCPU02, NE1A-SCPU01-EIP, and NE1A-SCPU02-EIP.

Certifying organization	Standards
TÜV Rheinland	IEC 61508 part 1-7 EN ISO 13849-1:2015 EN ISO 13849-2 IEC 61131-2 EN 62061 IEC 61326-3-1 EN 60204-1 EN ISO 13850 NFPA 79 ANSI RIA 15.06, ANSI B11.19
UL	ANSI/UL 1998, UL 508, ANSI/ISA 12.12.01, IEC 61508, CSA C22.2 No. 142, CSA C22.2 No. 213

■ Conformance to KC Certification

When you use this product in South Korea, observe the following precautions.

A 급기기 (업무용 방송통신기자재)
이 기기는 업무용(A 급) 전자파적합기기로서 판매자또는 사용자는 이 점을 주의하시기 바라며, 가정외의 지역에서 사용하는 것을 목적으로 합니다.

7 Unit Versions of NE1A-series Controllers

Checking the Unit Version

A “unit version” has been introduced to manage NE1A-series Safety Network Controllers according to differences in functionality accompanying Unit upgrades even though the model numbers are the same. The unit version can be checked on the product itself or using the Network Configurator.

Note The Network Configurator maintains a revision number to manage device functions for DeviceNet and EtherNet/IP. Refer to *Checking the Unit Version with the Network Configurator* on page xxv for the relationship between NE1A-series Controller unit versions and the revisions.

Checking the Unit Version on the Product Nameplate

The unit version (Ver. □.□) is listed near the lot number on the nameplate of the products for which unit versions are being managed, as shown below.

- The unit versions of the NE1A-SCPU01-V1, NE1A-SCPU02, NE1A-SCPU01-EIP, and NE1A-SCPU02-EIP Controllers begin from unit version 1.0.
- Controllers that do not have a unit version listed on the label are called Pre-Ver. 1.0 Controllers.

Product Nameplate

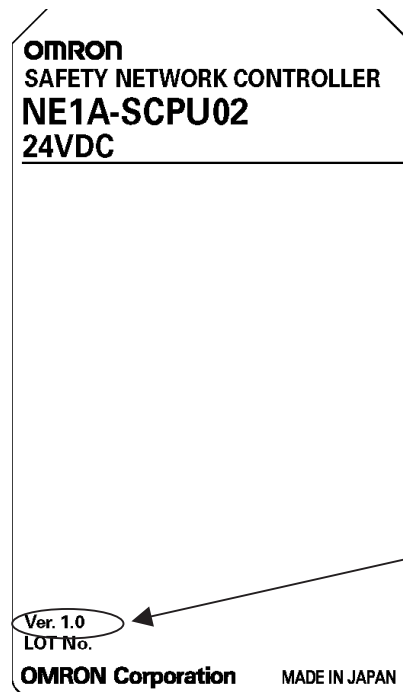

The unit version is listed here.
(Example: Ver. 1.0)

Checking the Unit Version with the Network Configurator

The following procedure can be used to check the unit version from the Network Configurator.

- 1,2,3...
1. Select **Upload** from the Network Menu to upload the configuration information. The device icons will be displayed, as shown in the following diagram.

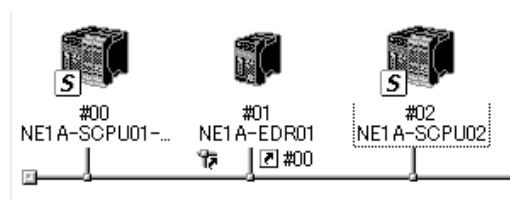

2. Right-click on a device icon to display the popup menu shown below and select **Property** from the menu.

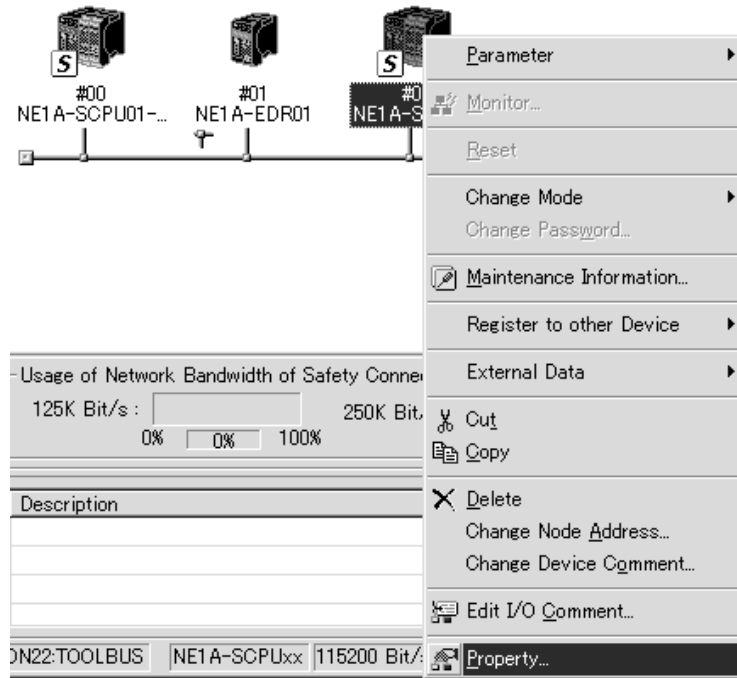

The following Property Dialog Box will be displayed.



The device name and revision are given in the Property Dialog Box. The NE1A-series Controllers supported by Network Configurator are listed in the following table.

■ CPU Units without EtherNet/IP

Model	Device name	Revision	Unit version
NE1A-SCPU01	NE1A-SCPU01	1.01	Pre-Ver. 1.0
NE1A-SCPU01-V1	NE1A-SCPU01-V1	1.0□	1.0
NE1A-SCPU01-V1	NE1A-SCPU01-V1	2.0□	2.0
NE1A-SCPU02	NE1A-SCPU02	1.0□	1.0
NE1A-SCPU02	NE1A-SCPU02	2.0□	2.0

■ CPU Units with EtherNet/IP

Model	Device name	Revision	Unit version
NE1A-SCPU01-EIP	NE1A-SCPU01-EIP	1.01	1.0
NE1A-SCPU01-EIP	NE1A-SCPU01-EIP	1.02	1.1
NE1A-SCPU02-EIP	NE1A-SCPU02-EIP	1.01	1.0
NE1A-SCPU02-EIP	NE1A-SCPU02-EIP	1.02	1.1

Checking the Unit Version with the Unit Version Label

The following unit version labels are provided with the Controller.

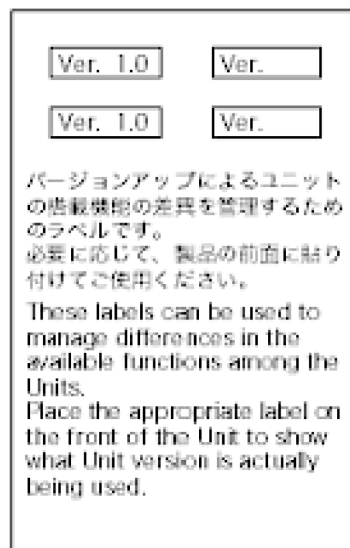

These labels can be attached to the front of the Controllers to differentiate between with different unit versions from the front of the Controllers.

Function Support by Unit Version

Model	NE1A-SCPU01	NE1A-SCPU01-V1	NE1A-SCPU02	NE1A-SCPU01-EIP	NE1A-SCPU02-EIP
Unit version	Pre-Ver. 1.0	Ver. 1.0 or 2.0	Ver. 1.0 or 2.0	Ver. 1.0 or 1.1	Ver. 1.0 or 1.1
Function					
Logic operations					
Maximum program size (total number of function blocks)	128	254	254	254	254
Added function blocks • RS Flip-flop • Multi Connector • Muting • Enable Switch • Pulse Generator • Counter • Comparator	---	Supported	Supported	Supported	Supported
Selection of the rising edge of the reset condition for the Reset and Restart Function Blocks	---	Supported	Supported	Supported	Supported
Use local I/O status in user programming	---	Supported	Supported	Supported	Supported
Use the Unit's general status in user programming	---	Supported	Supported	Supported	Supported
Waiting for safety I/O communications to start before starting program execution	---	Supported (Unit version 2.0 or later)	Supported (Unit version 2.0 or later)	Supported	Supported
I/O control functions					
Contact Operation Counter	---	Supported	Supported	Supported	Supported
Total ON Time Monitor	---	Supported	Supported	Supported	Supported
DeviceNet communications functions					
Number of safety I/O connections at the Safety Master	16	32	32	32	32
Selection of operation of safety I/O communications after a communications error	---	Supported	Supported	Supported	Supported
Add local output status to send data during Slave operation.	---	Supported	Supported	Supported	Supported
Add local input monitoring to send data during Slave operation.	---	Supported	Supported	Supported	Supported
Communications with devices on other networks (off-link connections)	---	Supported (Unit version 2.0 or later)	Supported (Unit version 2.0 or later)	Supported	Supported
Functions supporting system startup and error recovery					
Saving non-fatal error history in non-volatile memory	---	Supported	Supported	Supported	Supported
Added function block errors to error history.	---	Supported	Supported	Supported	Supported
EtherNet/IP communications					
I/O communications	---	---	---	Supported	Supported
Message communications	---	---	---	Supported	Supported
Reading and writing target I/O areas	---	---	---	Supported (Unit version 1.1 or later)	Supported (Unit version 1.1 or later)
Routing between DeviceNet and EtherNet/IP					
I/O routing	---	---	---	Supported	Supported
Message routing	---	---	---	Supported	Supported

Model	NE1A-SCPU01	NE1A-SCPU01-V1	NE1A-SCPU02	NE1A-SCPU01-EIP	NE1A-SCPU02-EIP
Unit version	Pre-Ver. 1.0	Ver. 1.0 or 2.0	Ver. 1.0 or 2.0	Ver. 1.0 or 1.1	Ver. 1.0 or 1.1
Function	UDP/IP message communications				
UDP/IP message communications	---	---	---	Supported (Unit version 1.1 or later)	Supported (Unit version 1.1 or later)

Unit Versions and Programming Devices

Network Configurator version 2.0□ or higher must be used when using a NE1A-SCPU01-V1 or NE1A-SCPU02 Safety Logic Controller with unit version 2.0.

Network Configurator version 2.2□ or higher must be used when using a NE1A-SCPU01-EIP or NE1A-SCPU02-EIP Safety Logic Controller with unit version 1.0.

Network Configurator version 3.3□ or higher must be used when using a NE1A-SCPU01-EIP or NE1A-SCPU02-EIP Safety Logic Controller with unit version 1.1.

The following table shows the relationship between unit versions and Network Configurator versions.

Model number	Network Configurator					
	Ver. 1.3□	Ver. 1.5□	Ver. 1.6□	Ver. 2.0□/ 2.1□	Ver. 2.2□	Ver. 3.3□
NE1A-SCPU01 Pre-Ver. 1.0	Can be used.	Can be used.	Can be used.	Can be used.	Can be used.	Can be used.
NE1A-SCPU01-V1 Unit Ver. 1.0	Cannot be used.	Cannot be used.	Can be used.	Can be used.	Can be used.	Can be used.
NE1A-SCPU02 Unit Ver. 1.0	Cannot be used.	Cannot be used.	Can be used.	Can be used.	Can be used.	Can be used.
NE1A-SCPU01-V1 Unit Ver. 2.0	Cannot be used.	Cannot be used.	Can be used. (See note 1.)	Can be used.	Can be used.	Can be used.
NE1A-SCPU02 Unit Ver. 2.0	Cannot be used.	Cannot be used.	Can be used. (See note 1.)	Can be used.	Can be used.	Can be used.
NE1A-SCPU01-EIP Unit Ver. 1.0	Cannot be used.	Cannot be used.	Cannot be used.	Cannot be used.	Can be used.	Can be used.
NE1A-SCPU02-EIP Unit Ver. 1.0	Cannot be used.	Cannot be used.	Cannot be used.	Cannot be used.	Can be used.	Can be used.
NE1A-SCPU01-EIP Unit Ver. 1.1	Cannot be used.	Cannot be used.	Cannot be used.	Cannot be used.	Can be used. (See note 1.)	Can be used.
NE1A-SCPU02-EIP Unit Ver. 1.1	Cannot be used.	Cannot be used.	Cannot be used.	Cannot be used.	Can be used. (See note 1.)	Can be used.

- Note**
- (1) Can be used as a Controller with unit version 1.0.
 - (2) Network Configurator version 1.5□ or lower can be upgraded to version 1.6□ free of charge.
 - (3) When using Network Configurator version 1.6□, there are no operational differences in the NE1A-SCPU01-V1 and NE1A-SCPU02 Safety Logic Controllers that derive from the unit version.

Unit Versions and Configuration Data

The following table shows the relationship between unit versions of NE1A-series Controllers in Network configuration files created with Network Configurator and the unit version of NE1A-series Controllers to which configuration files are downloaded.

Unit versions of NE1A-series CPU Unit in Network configuration files created with Network Configurator	NE1A-series CPU Unit to which configuration file is downloaded			
	Pre-Ver. 1.0 CPU Unit	CPU Unit with unit version 1.0	CPU Unit with unit version 2.0	CPU Unit with unit version 1.0/1.1 that supports EtherNet/IP
Pre-Ver. 1.0 CPU Unit	Downloading is possible.	Not possible. (See note 1.)	Not possible. (See note 1.)	Not possible. (See note 1.)
CPU Unit with unit version 1.0 that does not support EtherNet/IP	Not possible.	Downloading is possible.	Downloading is possible. (See note 2.)	Not possible. (See note 1.)
CPU Unit with unit version 2.0	Not possible.	Not possible.	Downloading is possible.	Not possible. (See note 1.)
CPU Unit with unit version 1.0/1.1 that supports EtherNet/IP	Not possible.	Not possible.	Not possible.	Downloading is possible.

- Note**
- (1) Downloading is possible if the device type is changed using the function provided in Network Configurator. For details, refer to *NE1A-series Controller Upgrade Procedure* on page xxx.
 - (2) Only functions CPU Units with unit version 1.0 can be used.

IMPORTANT The Configuration data created with unit version 1.0 can be downloaded to a NE1A-series Controller with unit version 2.0. The data will be subsequently treated as unit version 2.0 data if it is uploaded.

NE1A-series Controller Upgrade Procedure

Functions are added and functionality is expanded in various ways for the NE1A-series Controllers. The device type in an existing network configuration file can be changed to a higher version so that the new functionality can be used.

The following table shows the NE1A-series Control device types in network configuration files and the device types that they can be upgraded to.

Device type before change	Device type after change					
	NE1A-SCPU01-V1		NE1A-SCPU02		NE1A-SCPU01-EIP	NE1A-SCPU02-EIP
	Unit Ver. 1.0	Unit Ver. 2.0	Unit Ver. 1.0	Unit Ver. 2.0	Unit Ver. 1.0/1.1	Unit Ver. 1.0/1.1
NE1A-SCPU01 Pre-Ver. 1.0	OK	OK	OK	OK	OK	OK
NE1A-SCPU01-V1 Unit Ver. 1.0	---	OK	OK	OK	OK	OK
NE1A-SCPU01-V1 Unit Ver. 2.0	OK*	---	Not possible	OK	OK	OK
NE1A-SCPU02 Unit Ver. 1.0	Not possible	Not possible	---	OK	Not possible	OK
NE1A-SCPU02 Unit Ver. 2.0	Not possible	Not possible	OK*	---	Not possible	OK
NE1A-SCPU01-EIP Unit Ver. 1.0/1.1	Not possible	Not possible	Not possible	Not possible	---	OK
NE1A-SCPU02-EIP Unit Ver. 1.0/1.1	Not possible	Not possible	Not possible	Not possible	Not possible	---

*Conversion is possible, but off-link connection settings are not retained.

1. Reading Configuration Data

Use the following procedure to read the configuration data with the Network Configurator.

- Read the saved configuration data.
- Use network uploading to read configuration data from devices on the network.

The following screen will be displayed when reading has been completed.

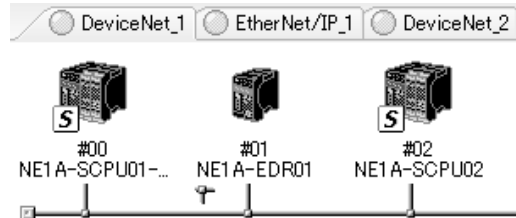

2. Converting Configuration Data

In the data that was read with the Network Configurator, select the NE1A-series Controller to convert to a higher version. Right-click and select **Change Device Type** from the pop-up menu.

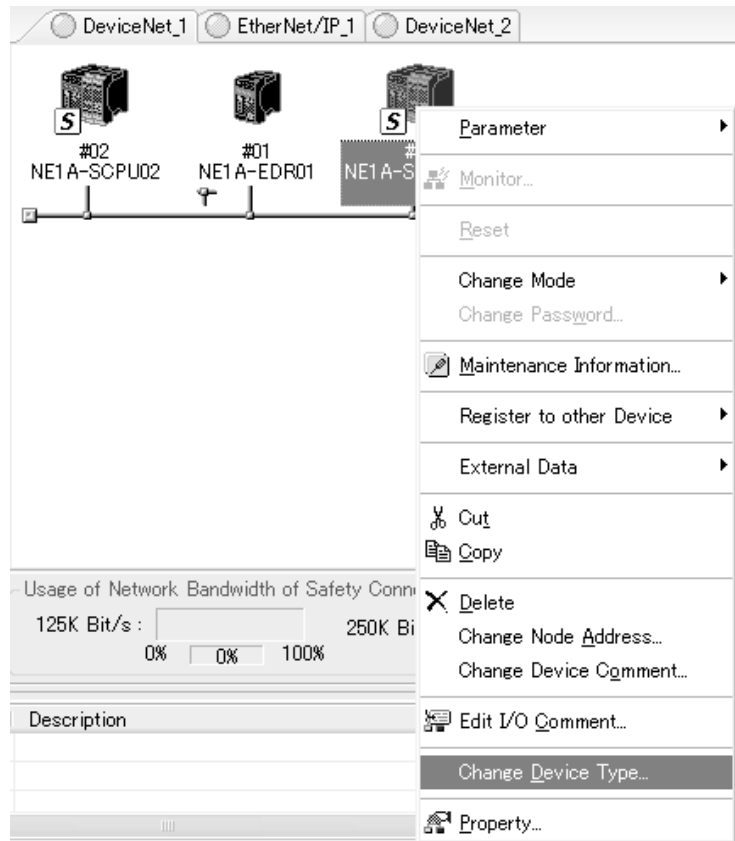

Next, select the new device in the New Device and press the OK Button.

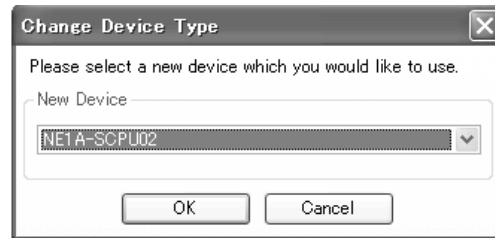

After a moment, the model number will change and the configuration data for the new device will be completed.

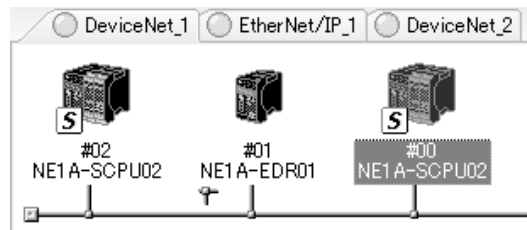

3. Expansion Configuration

When the data configuration is converted, all expanded functionality will be set to the default values. Set the configuration for all expanded functionality to be used.

IMPORTANT

- (1) When changing the device type using Network Configurator version 1.6□, open the Edit Device Parameters Dialog Box of the Controller, select a connection on the *Safety Connection* Tab Page, and click the *Update* Button.
- (2) When changing the device type using Network Configurator version 2.□ or higher, the connection information will be updated automatically.
- (3) Data cannot be converted to data for lower models.

SECTION 1

Overview of the NE1A-series Safety Network Controllers

1-1	About NE1A-series Safety Network Controllers	2
1-1-1	Introduction to the NE1A-series Safety Network Controllers	2
1-1-2	Features of the NE1A-series Controllers	3
1-1-3	Functional Overview	5
1-1-4	Functions Improved in Unit Version 2.0 and in Unit Version 1.0 of CPU Units with EtherNet/IP.	6
1-1-5	Functions Added for Controllers that Support EtherNet/IP	7
1-1-6	Comparison of the I/O Capacity of the NE1A-SCPU01(-V1)/NE1A-SCPU01-EIP and NE1A-SCPU02/NE1A-SCPU02-EIP	7
1-2	System Configuration	8
1-2-1	DeviceNet Safety System Overview	8
1-2-2	Example System Configurations	9
1-3	System Setup Procedure	18

1-1 About NE1A-series Safety Network Controllers

1-1-1 Introduction to the NE1A-series Safety Network Controllers

The NE1A-series Safety Network Controllers provide various functions, such as safety logic operations, safety I/O control, and a DeviceNet Safety protocol. The NE1A-series Controller allows the user to construct a safety control/network system that meets the requirements for Safety Integrity Level (SIL) 3 according to IEC 61508 (Functional Safety of Electrical/Electronic/Programmable Electronic Safety-related Systems) and the requirements for Safety Category 4 according to EN 954-1.

In the example system shown below, the safety control system implemented with an NE1A-series Controller and the monitoring system implemented with a Standard PLC are realized on the same network.

- As a Safety Logic Controller, the NE1A-series Controller executes safety logic operations and controls local I/O.
- As a DeviceNet Safety Master, the NE1A-series Controller controls the remote I/O of DeviceNet Safety Slaves.
- As a DeviceNet Standard Slave, the NE1A-series Controller communicates with the DeviceNet Standard Master.

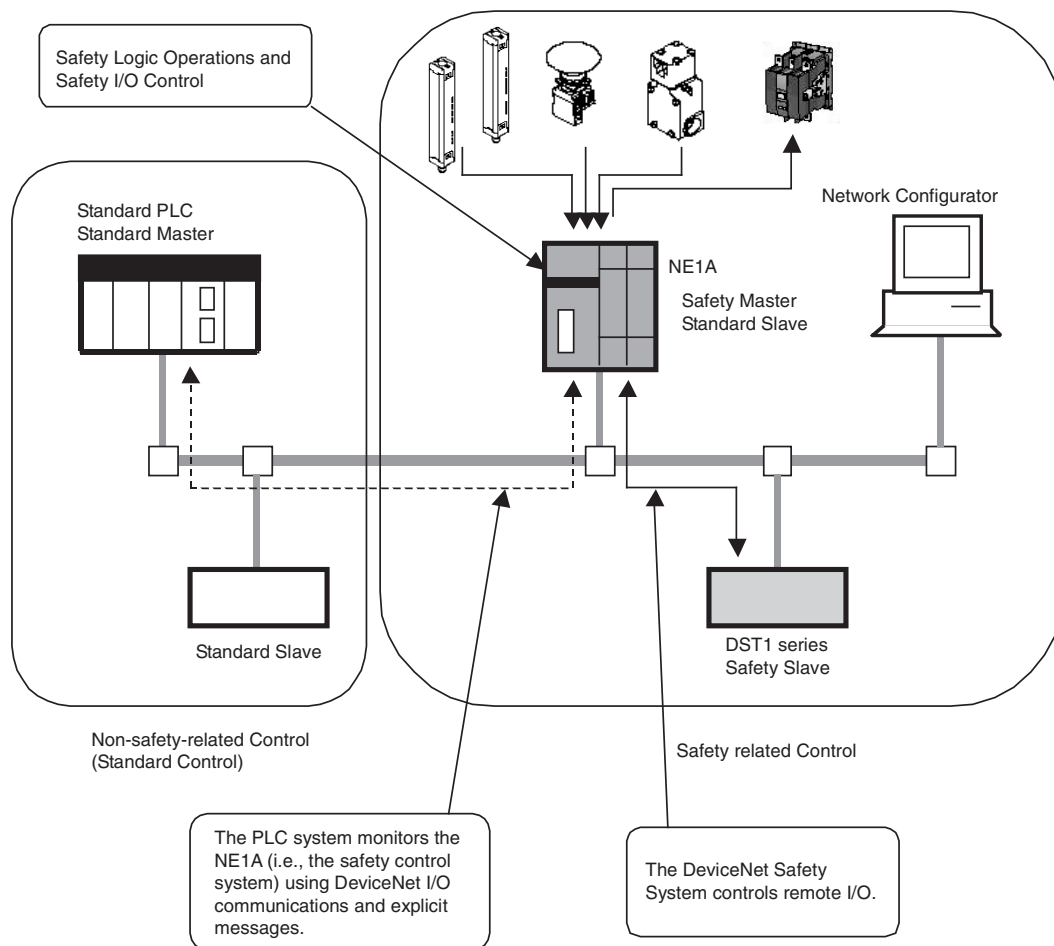

1-1-2 Features of the NE1A-series Controllers

Safety Logic Operations

In addition to basic logic functions, such as AND and OR, function blocks such as Emergency Stop or Safety Gate Monitoring that enable various safety applications are supported.

Local Safety I/O

- In the NE1A-SCPU01(-V1), NE1A-SCPU01-EIP, a total of 24 local safety I/O points are supported: 16 inputs and 8 outputs.
- In the NE1A-SCPU02, NE1A-SCPU02-EIP, a total of 48 local safety I/O points are supported: 40 inputs and 8 outputs.
- Faults in external wiring can be detected.
- Dual Channel Mode can be set for pairs of related local input terminals. When Dual Channel Mode is set, an NE1A-series Controller can evaluate the input data patterns and the time discrepancy between input signals.
- Dual Channel Mode can be set for pairs of related local output terminals. When Dual Channel Mode is set, an NE1A-series Controller can evaluate the output data patterns.

DeviceNet Safety Communications

- As a Safety Master, Pre-Ver. 1.0 Controllers can perform safety I/O communications with up to 16 connections using up to 16 bytes per connection.
- As a Safety Master, an NE1A-series Controller with unit version 1.0 or later (including Controllers that support EtherNet/IP) can perform safety I/O communications with up to 32 connections using up to 16 bytes per connection.
- As a Safety Slave, the NE1A-series Controllers can perform safety I/O communications with a maximum of four connections using up to 16 bytes per connection.

DeviceNet Standard Communications

As a Standard Slave, the NE1A-series Controllers can perform standard I/O communications with one Standard Master for up to two connections using up to 16 bytes per connection.

EtherNet/IP Standard Communications (Only Controllers that Support EtherNet/IP)

As an EtherNet/IP target, an NE1A-series Controller can perform standard I/O communications with up to two connections with a single EtherNet/IP originator, using up to 128 bytes for input and 16 bytes for output per connection.

DeviceNet Communications Disable (Standalone) Setting

An NE1A-series Controller can be used as a Standalone Controller by disabling its DeviceNet communications.

Configuration with a Graphical Tool

- A graphical tool is provided for both network configuration and user programming. It enables easy configuration and programming.
- A Logic Editor can be activated from the Network Configurator.
- Configuration data can be downloaded and uploaded, and devices can be monitored online via DeviceNet, USB, EtherNet/IP, or the peripheral interface of an OMRON PLC.

System Startup and Error Recovery Support

- The error information can be checked by using the Network Configurator or the indicators on the front of the NE1A-series Controller.
- The NE1A-series Controller's internal status information can be monitored from a Standard PLC by allocating the information in the Standard Master. In the same way, monitoring with a Safety PLC is possible by allocating information in the Safety Master.
- An NE1A-series Controller's internal status information can be allocated in an EtherNet/IP originator and monitored by a Standard PLC. (Possible only for Controllers that support EtherNet/IP.)

Access Control with a Password

- The NE1A-series Controller's configuration data is protected by a password set in the Controller.
- The Network Configurator controls access to each project file with a password.

UDP/IP Message Communications

Message communications with UDP/IP frames can be performed from general-purpose controllers on Ethernet (PLCs, computers, etc.) through NE1A-series Controllers to access NE1A-series Controllers or devices on DeviceNet Safety or DeviceNet networks. (This function is supported only for Controllers with EtherNet/IP and unit version 1.1 or later.)

Reading NE1A-series EtherNet/IP Target I/O Areas (CPU Units with EtherNet/IP, Unit Version 1.1 or Later)

With an NE1A-series CPU Unit with EtherNet/IP (unit version 1.1 or later), standard I/O communications targets can be set for EtherNet/IP to read EtherNet/IP standard I/O areas from explicit message clients without using a dedicated EtherNet/IP standard originator.

Writing NE1A-series EtherNet/IP Target I/O Areas (CPU Units with EtherNet/IP, Unit Version 1.1 or Later)

With an NE1A-series CPU Unit with EtherNet/IP (unit version 1.1 or later), standard I/O communications targets can be set for EtherNet/IP to write EtherNet/IP standard I/O areas from explicit message clients without using a dedicated EtherNet/IP standard originator.

1-1-3 Functional Overview

Function	Overview	Details
Logic Operations		
Logic operations	<p>Basic logic operations, such as AND and OR, and function blocks, such as Emergency Stop (ESTOP) and Safety Gate Monitoring (SGATE), are supported.</p> <p>In the Pre-Ver. 1.0 Controllers, up to 128 logic functions and function blocks can be used in programming.</p> <p>In the Controllers with unit version 1.0 or later (including Controllers that support EtherNet/IP), up to 254 logic functions and function blocks can be used in programming.</p>	SECTION 8
Safety I/O		
I/O comments	The user can store any name for each I/O terminal using a maximum of 32 characters (ASCII).	7-1-1
I/O power monitoring	The NE1A-series Controllers can detect whether I/O power is supplied within the normal voltage range.	7-1-2
Safety inputs	<p>The NE1A-SCPU01(-V1) and NE1A-SCPU01-EIP support 16 safety inputs.</p> <p>The NE1A-SCPU02 and NE1A-SCPU02-EIP support 40 safety inputs.</p>	7-2
Input circuit diagnosis	Test pulses are used to check the NE1A-series Controller's internal circuits, external devices, and external wiring.	
Input ON/OFF delays	Input time constants between 0 and 126 ms in multiples of the Controller's cycle time can be set for Controller's inputs. Setting input ON/OFF delays helps reduce influence from chattering or external noise.	
Dual Channel Mode	Time discrepancies in changes in data or input signals between two paired local inputs can be evaluated.	
Test pulse outputs	<p>The NE1A-SCPU01(-V1) and NE1A-SCPU01-EIP support four independent test outputs.</p> <p>The NE1A-SCPU02 and NE1A-SCPU02-EIP support eight independent test outputs.</p> <p>These are normally used in combination with safety inputs. They can also be set for use as signal output terminals.</p>	7-3
Current monitoring for muting lamp (T3, T7 terminal only)	<p>The NE1A-SCPU01(-V1) and NE1A-SCPU01-EIP can detect a disconnection at the T3 terminal.</p> <p>The NE1A-SCPU02 and NE1A-SCPU02-EIP can detect disconnections at the T3 and T7 terminals.</p>	
Overcurrent detection/protection	An output is blocked when an overcurrent is detected to protect the circuit.	
Safety outputs	The NE1A-SCPU01(-V1), NE1A-SCPU01-EIP, NE1A-SCPU02, and NE1A-SCPU02-EIP all support eight safety outputs.	7-4
Output circuit diagnosis	Test pulses are used to check the NE1A-series Controller's internal circuits, external devices, and external wiring.	
Overcurrent detection/protection	To protect the circuit, the output is cut off when an overcurrent is detected.	
Dual Channel Mode	Both of two paired outputs can be set into a safety state when an error occurs in either of the two paired local outputs without depending on the user program.	
DeviceNet Communications		
Safety Master	A master-slave relationship is established for each connection on the DeviceNet Safety Network separate from the Master-Slave communications on the DeviceNet Standard Network. This enables the NE1A-series Controller to be the safety master to control the connections.	4-4
Safety Slave	An NE1A-series Controller can also operate as a DeviceNet Safety Slave, and the Controller's internal status information as well as a specified area of I/O can be allocated in the Safety Master.	4-5

Function	Overview	Details
Safety I/O communications operating mode for communications errors	The operating mode to use for safety I/O communications when a communications error occurs can be selected. <ul style="list-style-type: none"> • Automatic recovery (previous function). • Stop only the connection where the error occurred. • Stop all connections. 	4-4
Standard Slave	An NE1A-series Controller can also operate as a Standard Slave, and the Controller's internal status information as well as a specified area of I/O can be allocated in the Standard Master.	4-6
Explicit messages	Explicit messages can be used to read an NE1A-series Controller's status information. In addition, explicit messages set from the Network Configurator can be sent from the user program.	SECTION 6
Automatic baud rate detection	The NE1A-series Controller's baud rate can be set automatically to match the baud rate of the network master.	4-1-1
DeviceNet Communications Disable (Standalone)		
DeviceNet communications disable (Standalone) setting	An NE1A-series Controller can be used as a Standalone Controller by disabling the Controller's DeviceNet communications.	4-1-2
System Startup/Error Recovery Functions		
Error history	Errors detected by the NE1A-series Controller are recorded along with the Controller's total operating time at the point that the error was detected.	12-4
Online monitoring	The NE1A-series Controller's internal status information and I/O data can be monitored online from the Network Configurator.	System Configuration Manual, Section 7
Other Functions		
Configuration lock	The configuration data stored in the NE1A-series Controller can be locked to protect the data after it has been downloaded and verified.	9-1
Reset	The NE1A-series Controller can be reset from the Network Configurator.	9-2
Password	A password can be set to prevent unintended or unauthorized access to the NE1A-series Controller.	9-3

1-1-4 Functions Improved in Unit Version 2.0 and in Unit Version 1.0 of CPU Units with EtherNet/IP

The following table outlines the functions that were improved in unit version 2.0 and in unit version 1.0 of CPU Units with EtherNet/IP.

Function	Summary	Reference
Logic operations		
Program execution delay	This function enables waiting for safety I/O communications to start before executing the program. Even if this function is used, however, program execution may start before safety I/O communications and logic errors may occur for function blocks under some circumstances. This function can be enabled to prevent certain logic errors.	10-1-6

1-1-5 Functions Added for Controllers that Support EtherNet/IP

For Controllers that support EtherNet/IP, the following functions have been added to those of the NE1A-SCPU01(-V1) and NE1A-SCPU02.

Function	Overview	Details
EtherNet/IP Communications Functions		
I/O communications	The Controller can perform I/O communications as an EtherNet/IP target. Not only specified I/O areas but NE1A-series Controller internal status information and DeviceNet Safety I/O connection information can be allocated in the originator.	SECTION 5
Explicit message communications	NE1A-series Controller status information can be read by services using explicit message communications. Also, Controllers with unit version 1.1 or later can be used to read and write EtherNet/IP target I/O areas.	SECTION 6
Routing between DeviceNet and EtherNet/IP		
I/O routing	DeviceNet Safety I/O connection information can be routed to an EtherNet/IP I/O connection.	SECTION 5
Message routing	Explicit message can be routed between DeviceNet and EtherNet/IP.	SECTION 5
UDP/IP message communications (Unit version 1.1 or later)		
UDP/IP message communications	Message communications with UDP/IP frames can be used to access NE1A-series Controllers (CPU Units with EtherNet/IP, unit version 1.1 or later) or to access devices on DeviceNet Safety or DeviceNet networks.	SECTION 5

1-1-6 Comparison of the I/O Capacity of the NE1A-SCPU01(-V1)/NE1A-SCPU01-EIP and NE1A-SCPU02/NE1A-SCPU02-EIP

Item	NE1A-SCPU01(-V1) NE1A-SCPU01-EIP	NE1A-SCPU02 NE1A-SCPU02-EIP	Details
Number of I/O points			
Safety inputs	16	40	2-1
Test outputs	4	8	2-1
Safety outputs	8	8	2-1

1-2 System Configuration

1-2-1 DeviceNet Safety System Overview

DeviceNet is an open-field, multi-vendor, multi-bit network, which combines the controls in the machine and line control levels with information. The DeviceNet Safety network adds safety functions to the conventional DeviceNet standard communications protocol. The DeviceNet Safety concept has been approved by a third-party organization (TÜV Rhineland).

Just as with DeviceNet, DeviceNet Safety-compliant devices from third-party vendors can be connected to a DeviceNet Safety network. Also, DeviceNet-compliant devices and DeviceNet Safety-compliant devices can be combined and connected on the same network.

By combining DeviceNet Safety-compliant products, a user can construct a safety control/network system that meets the requirements for Safety Integrity Level (SIL) 3 according to IEC 61508 (Functional Safety of Electrical/Electronic/Programmable Electronic Safety-related Systems) and the requirements for Safety Category 4 according to EN 954-1.

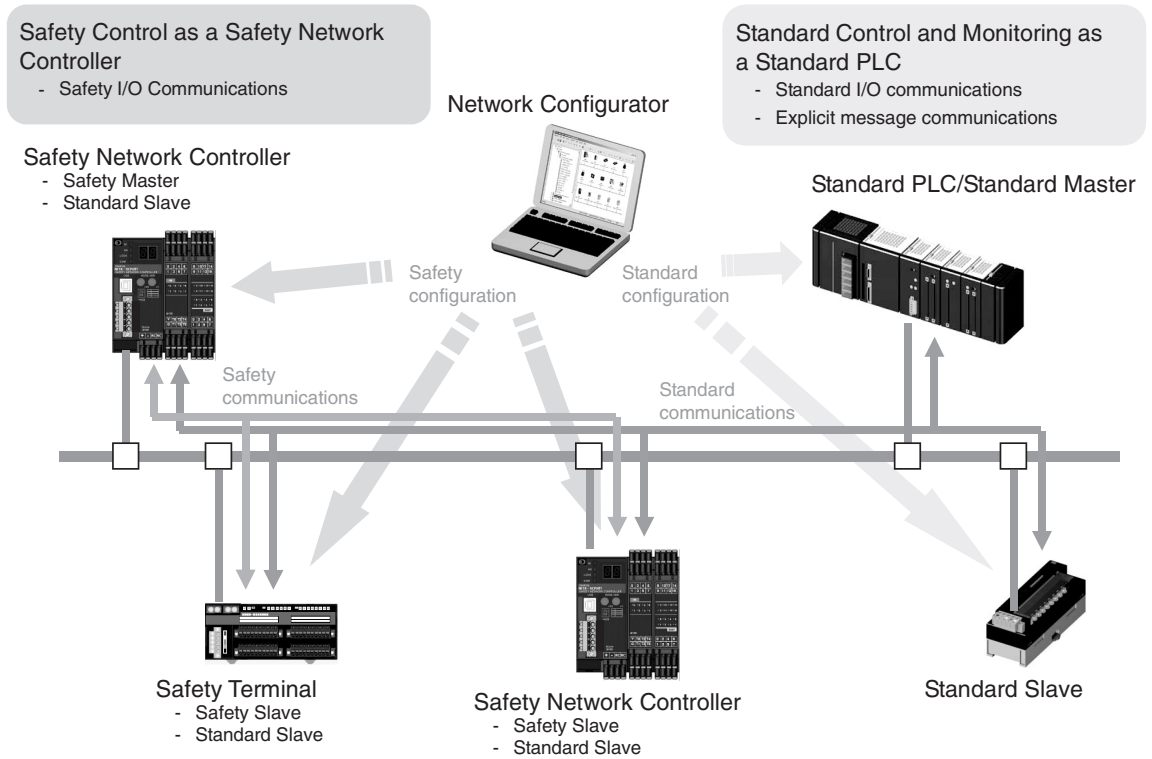

1-2-2 Example System Configurations

The following examples illustrate safety control systems using NE1A-series Controllers.

- Safety Control System with an NE1A-series Safety Master
- System Combining an NE1A-series Safety Control System and a Standard PLC Monitoring Control System
- System Combining a Distributed Safety Control System with Multiple NE1A-series Controllers and a Centralized Monitoring System Using Standard PLCs
- Standalone NE1A-series Controller System
- Connection with a Network Configurator

Safety Control System with an NE1A-series Safety Master

This system uses the NE1A-series Controller as a Safety Master and establishes a Safety Remote I/O System with Safety Slaves.

The Pre-Ver. 1.0 Controllers can perform safety I/O communications as a Safety Master for a maximum of 16 connections (16 Slaves) with up to 16 bytes per connection.

Controllers with unit version 1.0 or later (including Controllers that support EtherNet/IP) can perform safety I/O communications as a Safety Master for a maximum of 32 connections (32 Slaves) with up to 16 bytes per connection.

The NE1A-series Controllers support two protocols, single cast and multicast (broadcast), for safety I/O connections.

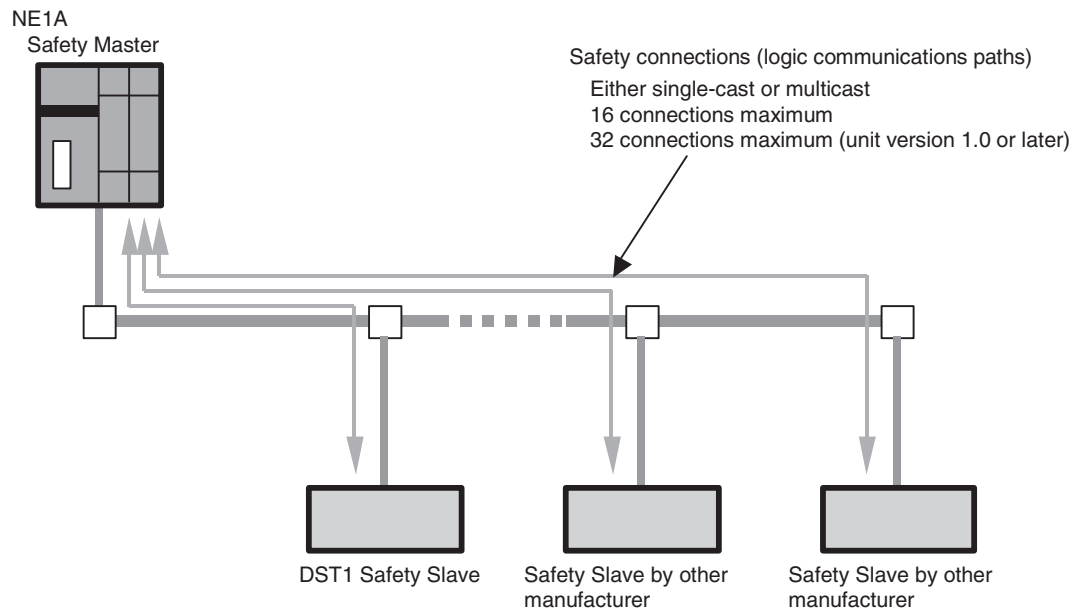

System Combining a Safety Control System and a PLC Monitoring Control System

This system uses the NE1A-series Controller as a Safety Master and establishes a Safety Remote I/O System with Safety Slaves.

The NE1A-series Controller is used as a Standard Slave and standard I/O communications are performed with the Standard Master. The NE1A-series Controller simultaneously functions as the Safety Master and a Standard Slave.

As a Standard Slave, the NE1A-series Controller enables standard I/O communications for a maximum of two connections with up to 16 bytes per connection. Four protocols (i.e., Poll, Bitstrobe, COS and Cyclic) are supported for I/O connections. The NE1A-series Controller cannot operate as a Standard Master.

The Safety Control System can be monitored using a Standard PLC by allocating the NE1A-series Controller’s status information (general status, local I/O error status, or other information) or logic operation results in the Standard PLC for standard I/O communications.

A Safety System and a Monitoring System can be combined and established on the same network by using standard devices and safety devices.

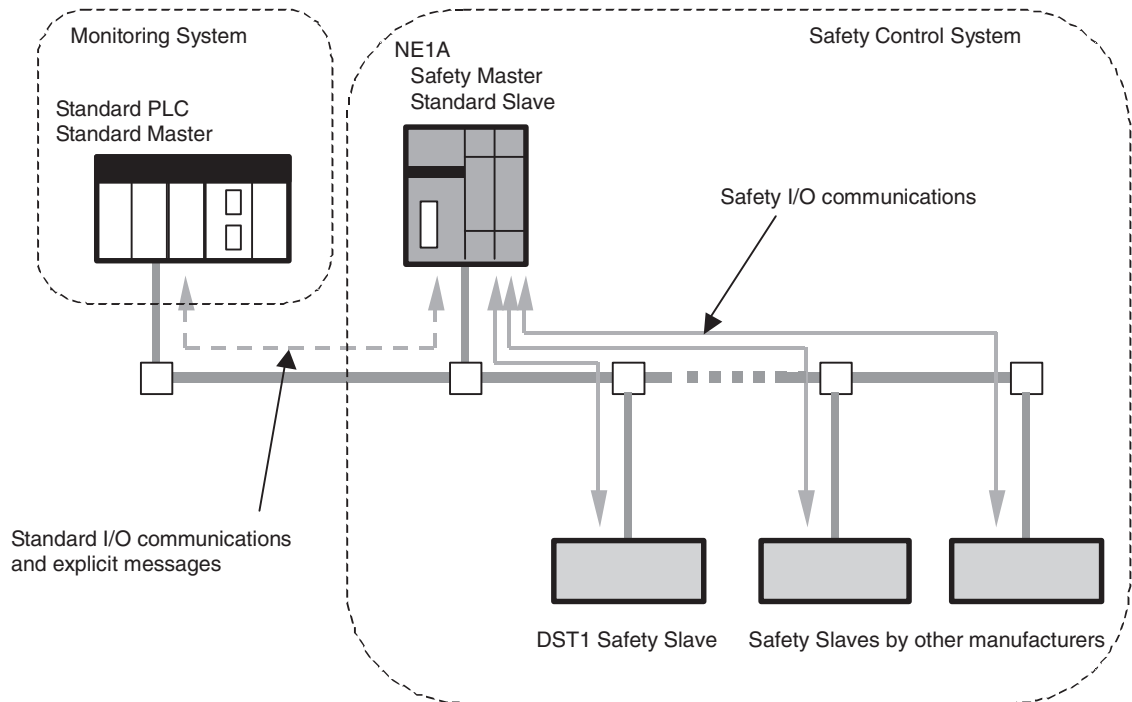

IMPORTANT The data attributes handled by standard I/O communications and explicit message communications are non-safety data. The necessary measures for safety data are not taken for this data during data generation. Therefore, do not use this data to configure the Safety Control System.

A maximum total of 64 standard nodes and safety nodes can be connected on the same DeviceNet network.

System Combining a Distributed Safety Control System with Multiple NE1A-series Controllers and a Centralized Monitoring System

This system uses each NE1A-series Controller as a Safety Master and establishes a Safety Remote I/O System with Safety Slaves.

Each NE1A-series Controller also simultaneously functions as a Standard Slave and standard I/O communications are performed with the Standard Master.

The Safety Control System can be monitored using a Standard PLC by allocating the NE1A-series Controller's status information (general status, local I/O error status, or other information) or logic operation results in the Standard PLC.

In the DeviceNet Safety System, multiple Safety Masters can be connected on the same network. Therefore, the distributed safety control blocks can be monitored centrally on the same network.

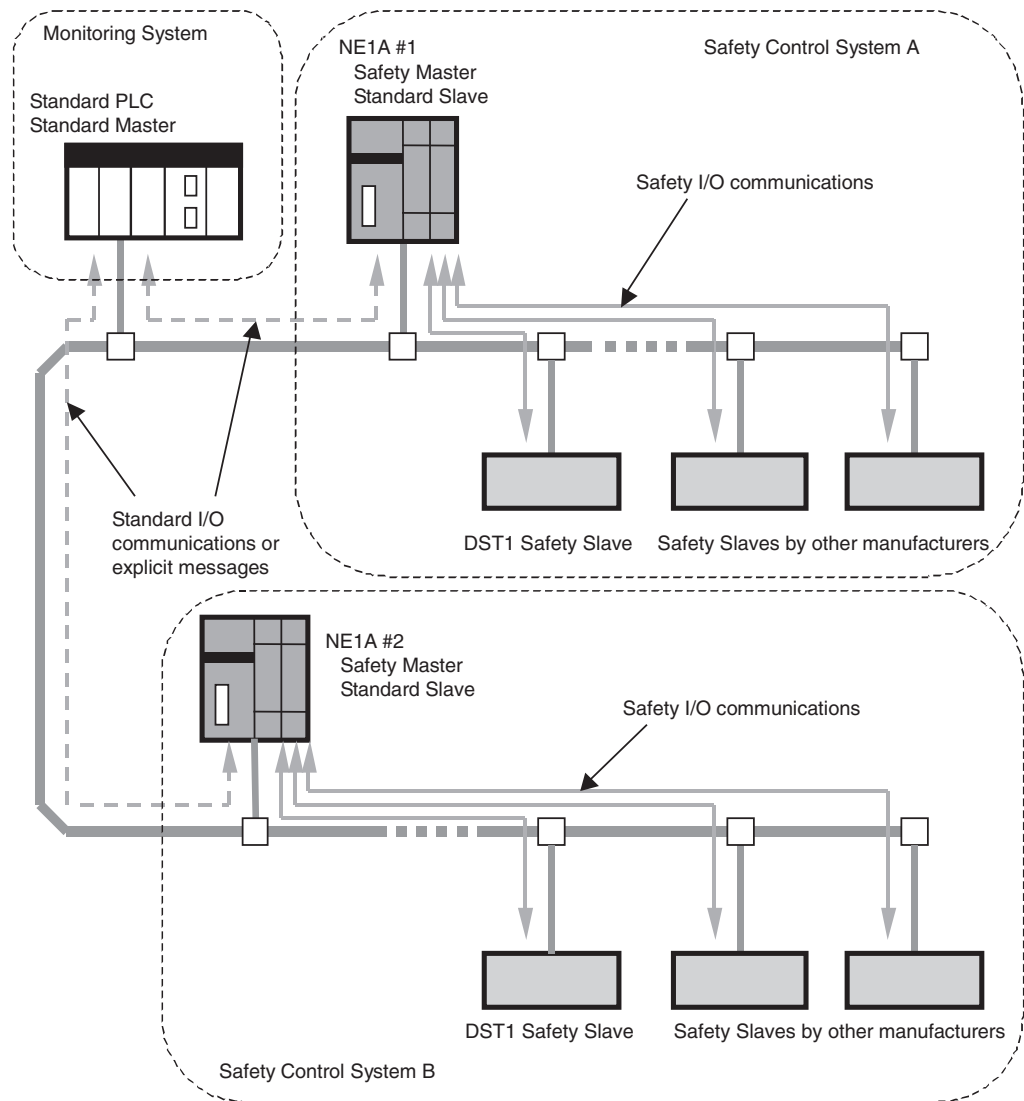

Also, safety I/O communications between NE1A-series Controllers can be performed as illustrated in the following diagram. In the diagram, NE1A #2 is set as the slave of NE1A #1 safety connections to perform safety I/O communications.

The NE1A-series Controller functions as a Safety Master, Safety Slave, and Standard Slave simultaneously. As a Safety Slave, the NE1A-series Controller enables safety I/O communications for a maximum of four connections with up to 16 bytes per connection.

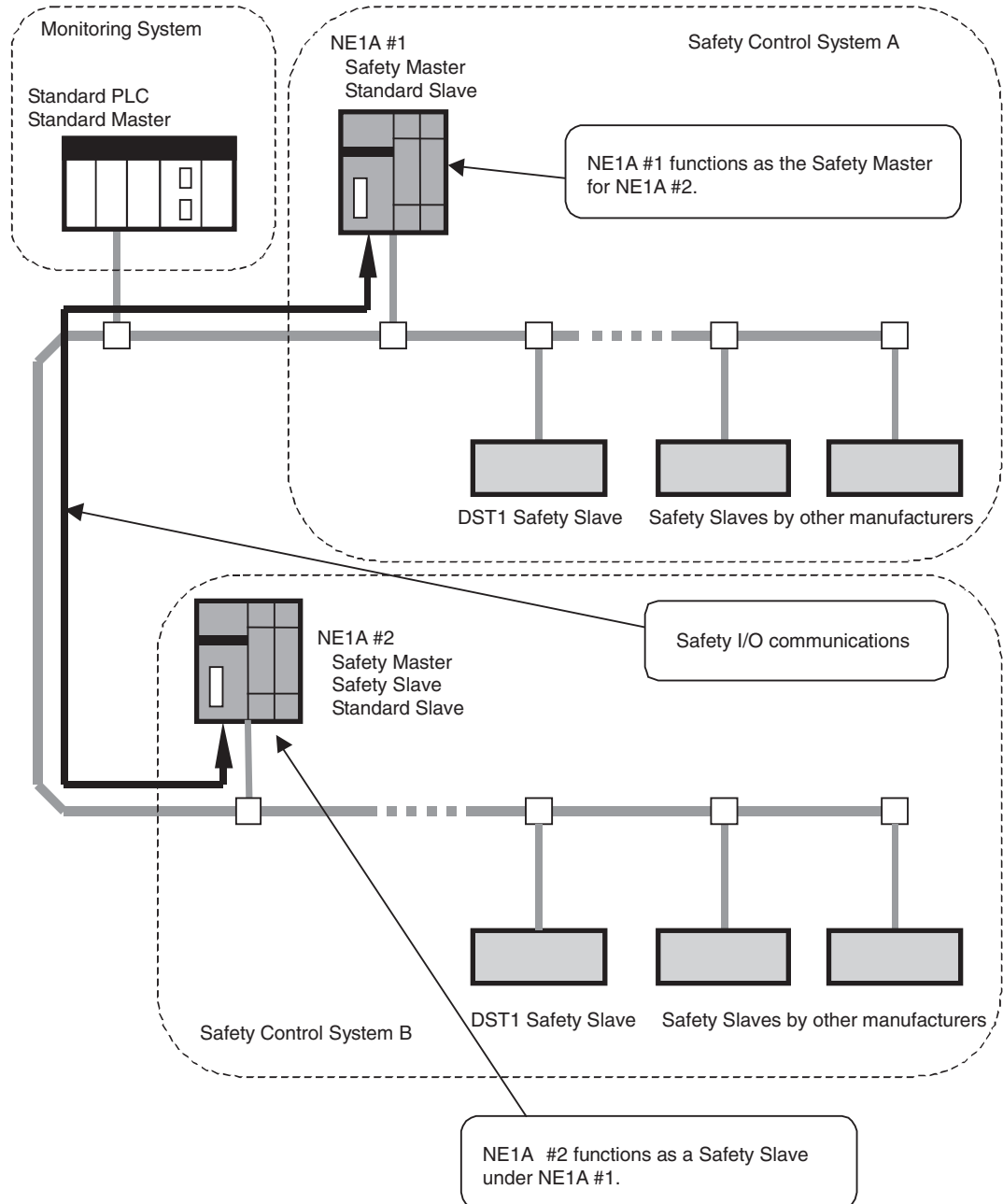

IMPORTANT The data attributes handled by DeviceNet standard I/O communications and explicit message communications are non-safety data. The necessary measures for safety data are not taken for this data during data generation. Therefore, do not use this data to configure the Safety Control System.

Monitoring DeviceNet or DeviceNet Safety Systems via Ethernet from Controller Made by Other Manufacturers

If the networks are constructed using an NE1A-EDR01 EtherNet/IP DeviceNet Router or NE1A-series CPU Units with EtherNet/IP (unit version 1.1 or later), devices on DeviceNet or DeviceNet Safety networks can be accessed from general-purpose controllers (e.g., PLCs or computers) in an Ethernet network using the UDP service. This enables monitoring a DeviceNet or DeviceNet Safety control system via Ethernet from a machine controller or monitor computer that does not support a DeviceNet interface or an EtherNet/IP interface. This can be used to easily add a DeviceNet Safety control system to an existing system.

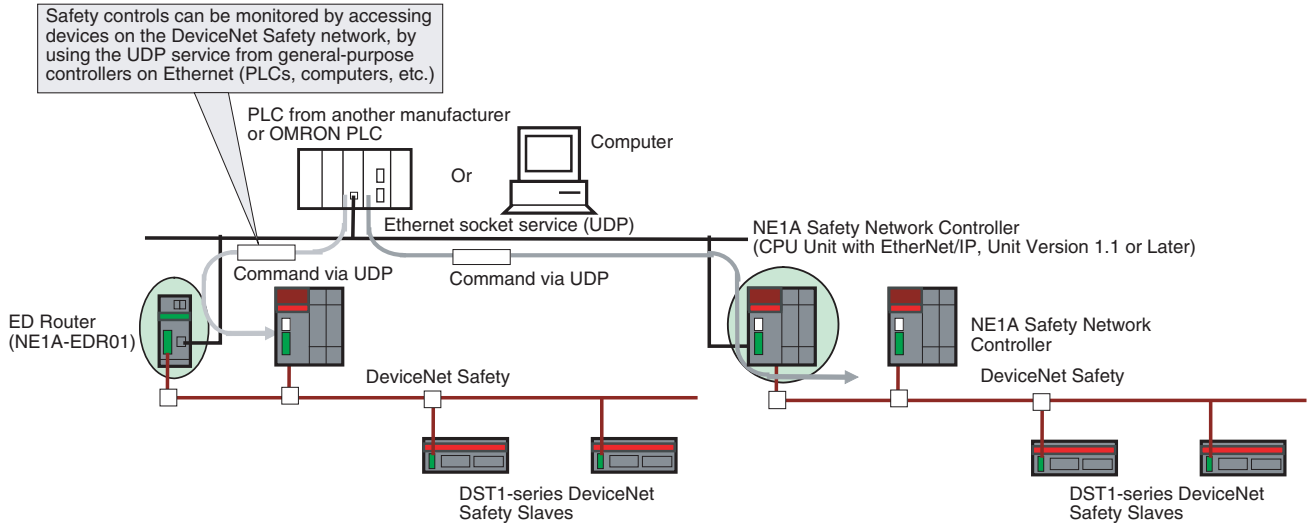

Note Refer to the *EtherNet/IP-DeviceNet Router Operation Manual* (Cat. No. Z912) for details on the NE1A-EDR01 EtherNet/IP-DeviceNet Router.

Monitoring a DeviceNet Safety (or DeviceNet) System from a PLC or Controller on an EtherNet/IP Network

As shown in the following diagram, a DeviceNet Safety (or DeviceNet) system can be monitored using EtherNet/IP Standard Target I/O from a PLC or Controller on an EtherNet/IP network via an NE1A-series Controller that supports EtherNet/IP.

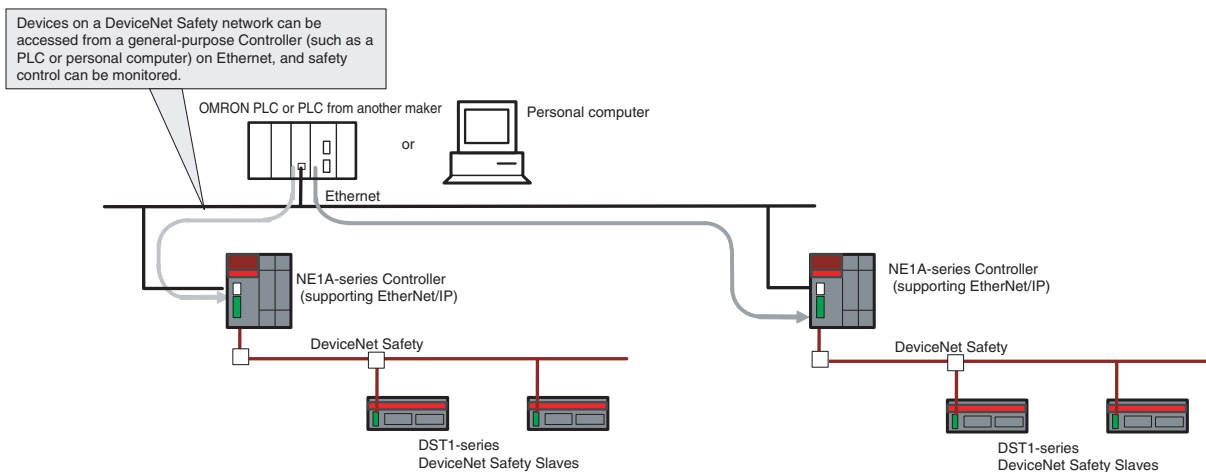

NE1A-series Controller DeviceNet Communications Disable (Standalone) Setting

When only a few I/O points are required for safety control, the NE1A-series Controller's DeviceNet communications can be disabled so that it can be used as a Standalone Controller.

Use the Network Configurator to disable the DeviceNet communications (standalone).

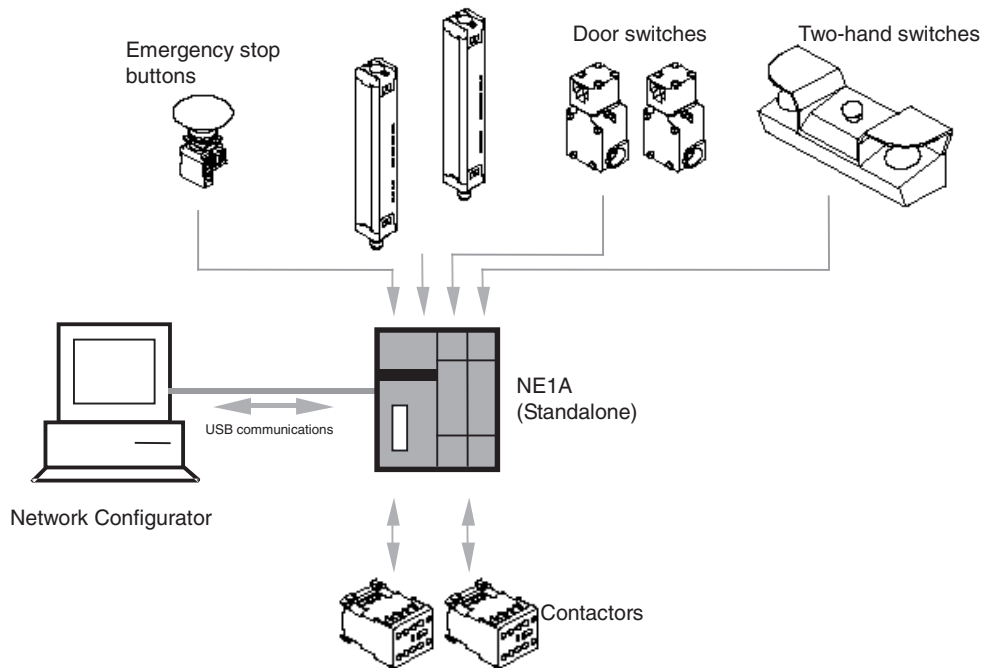

IMPORTANT Use a USB port connection to disable the DeviceNet communications (standalone). With Controllers that support EtherNet/IP, either the USB port or EtherNet/IP can be used. DeviceNet communications are stopped after DeviceNet communications are disabled (standalone), so the setting cannot be made from the DeviceNet port.

Connection with Network Configurator

The NE1A-series Controller is set and programmed using a Network Configurator. The Network Configurator also enables uploading configuration data, online monitoring of program execution status, error history checks, etc.

The Network Configurator can be used in the following ways:

- Direct connection to DeviceNet
- USB connection to the NE1A-series Controller
- Serial connection to an OMRON PLC
- Connection from Ethernet using an EtherNet/IP-DeviceNet Router
- Direct connection to EtherNet/IP (for Controllers that support EtherNet/IP)

Direct Connection to DeviceNet

A DeviceNet Board/Card enables the Network Configurator to connect directly to the network. Remote configuration and monitoring are supported for standard nodes and safety nodes on the network. When connected directly to DeviceNet, the Network Configurator forms one node on the network.

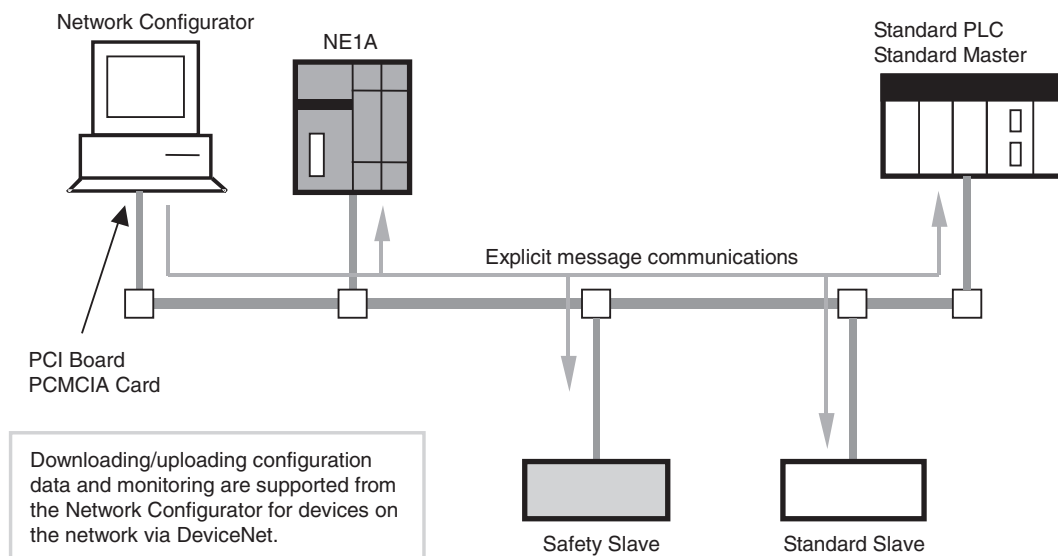

USB Connection to an NE1A-series Controller

The Network Configurator can be used by connecting to the USB port on the NE1A-series Controller. Remote configuration and monitoring are supported for not only the Controller connected to the USB port but also for other devices on the network. For a USB connection, the Network Configurator does not use a node address on the network.

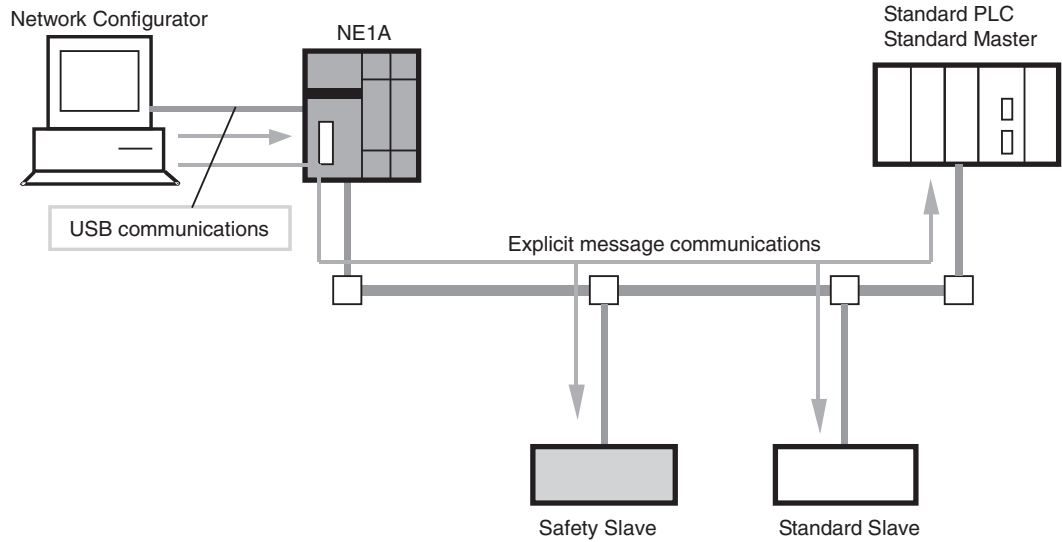

Serial Connection to an OMRON PLC

The Network Configurator can be used by connecting to a serial port on an OMRON PLC. Remote configuration and monitoring are supported for standard nodes and safety nodes on the network. For a PLC connection, the Network Configurator does not use a node address on the network.

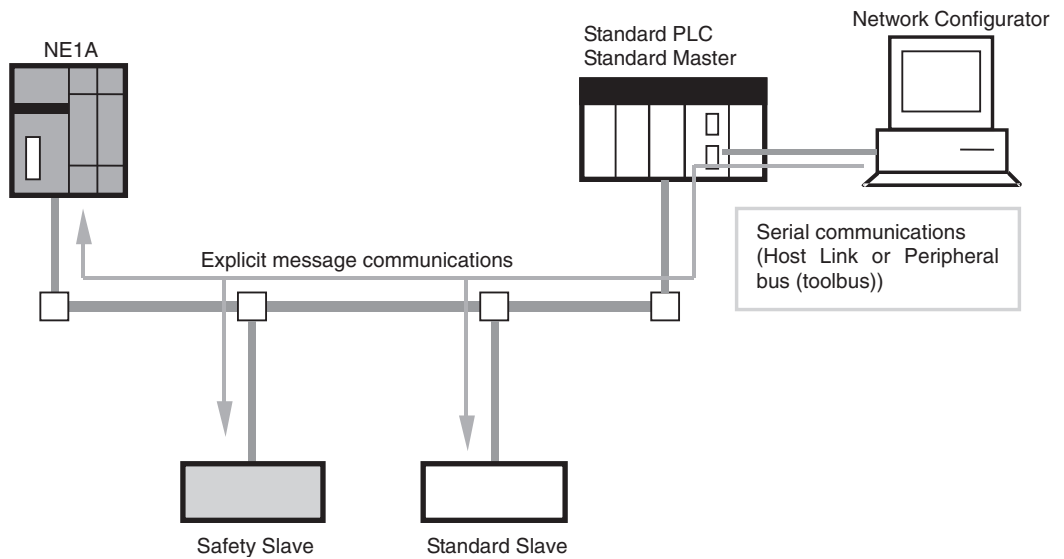

- Note** Check the following when downloading from a Standard Master to the NE1A.
- The timeout monitor time for the Standard Master must be at least 15 seconds.
 - Remote I/O communications from the Standard Master to the NE1A must be stopped (disconnected).

Connecting via an EtherNet/IP-DeviceNet Router

If the networks are built using an NE1A-EDR01 EtherNet/IP-DeviceNet Router, a Network Configurator connected at any point can be used to access the NE1A Safety Network Controllers through the EtherNet/IP-DeviceNet Router. The Network Configurator can be at any of the following locations.

- Connected via to a USB port on a Safety Network Controller on a different DeviceNet Safety network (See note 1.)
- Connected to an EtherNet/IP network
- Connected to a different DeviceNet Safety network

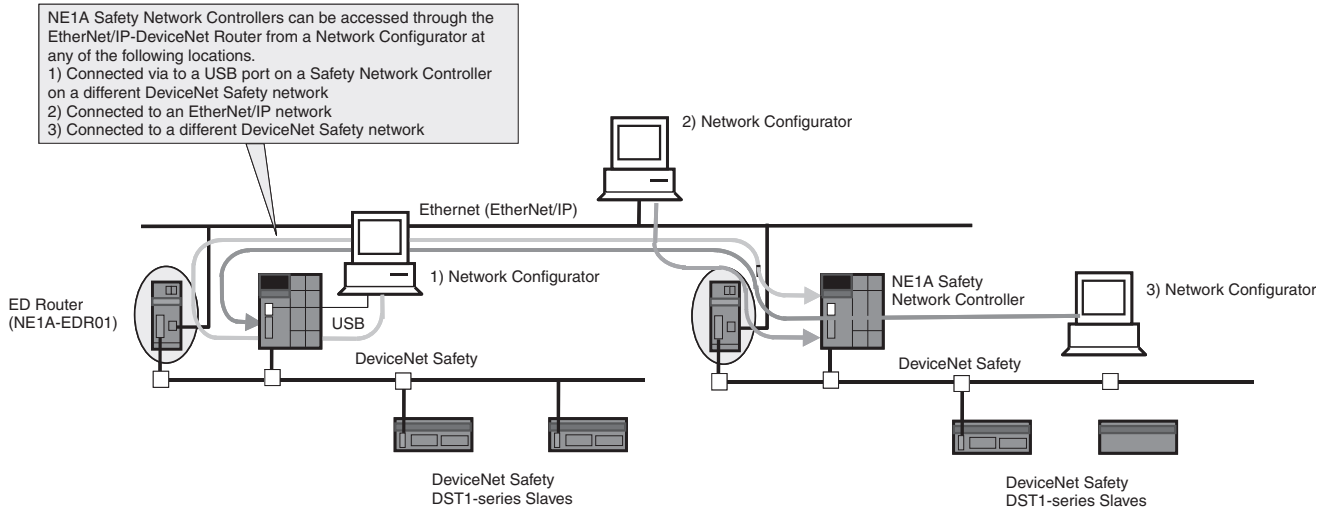

- Note**
- (1) The NE1A-SCPU01-V1 with unit version 2.0 or later, NE1A-SCPU01-EIP with unit version 1.0 or later, NE1A-SCPU02 with unit version 2.0 or later, or NE1A-SCPU02-EIP with unit version 1.0 or later is required. NE1A Safety Network Controllers cannot be accessed through an EtherNet/IP-DeviceNet Router from a Network Configurator connected to the USB port on the NE1A-SCPU01-V1 with unit version 1.0, or the NE1A-SCPU02 with unit version 1.0 or earlier.
 - (2) Refer to the *EtherNet/IP-DeviceNet Router Operation Manual* (Cat. No. Z912) for details on the NE1A-EDR01 EtherNet/IP-DeviceNet Router.

Direct Connection to EtherNet/IP (for Controllers that Support EtherNet/IP)

Remote configuration and monitoring are enabled for standard and safety devices on both EtherNet/IP and DeviceNet networks.

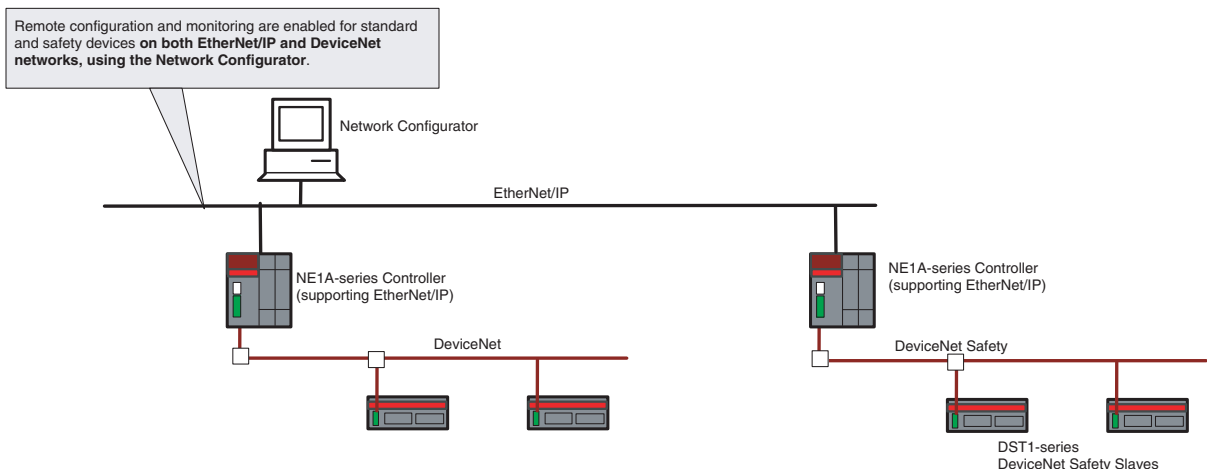

1-3 System Setup Procedure

The general working phases until the Safety System is operational are shown below.

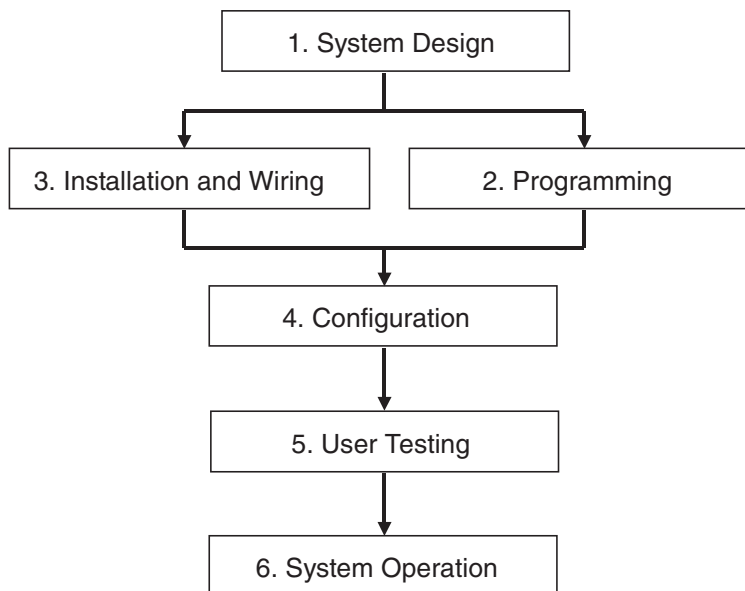

The NE1A-series Controller information required in each phase is described in the following sections.

Working phase	Required information	Details
System design	<ul style="list-style-type: none"> • System overview and example configurations • Specifications and functions • Performance 	Section 1 Section 2, Section 4 to 10 Section 11
Programming	<ul style="list-style-type: none"> • Programming guidelines • Function block specifications 	Section 8
Installation and wiring	<ul style="list-style-type: none"> • Node address and baud rate settings • Installation location • Device connections <ul style="list-style-type: none"> • Power supply wiring • Connection with I/O devices • Wiring for DeviceNet • EtherNet/IP wiring 	Section 4-1 Section 3
Configuration	<ul style="list-style-type: none"> • Configuration method 	Section 9
User test	<ul style="list-style-type: none"> • Error classification and error history 	Section 12
System operation	<ul style="list-style-type: none"> • Maintenance and inspection 	Section 13

Refer to the following manuals for information on DeviceNet and EtherNet/IP installation, DeviceNet Safety System construction, Network Configurator operation, Programming Device operation, and other devices used in the safety system.

Item	Manual name	Cat. No.
Installation of DeviceNet	DeviceNet User's Manual	W379
Installation of EtherNet/IP	NE1A-series DeviceNet Safety Network Controller Operation Manual	Z906-E1-07 or higher

Item	Manual name	Cat. No.
Construction of a DeviceNet Safety System	DeviceNet Safety System Configuration Manual	Z905
Network Configurator Operation (WS02-CFSC1-E)		
Programming Device Operation		
Installation of Safety I/O Terminals	DeviceNet Safety I/O Terminal Operation Manual	Z904

SECTION 2

Specifications and Nomenclature

2-1	Nomenclature and Functions	22
2-1-1	Nomenclature	22
2-1-2	Indicator/Display Areas	26
2-1-3	Switch Settings	30
2-1-4	DeviceNet Communications Connector	31
2-1-5	USB Communications Connector	31
2-1-7	Input/Output Terminals and Internal Connections	32
2-2	Specifications	36
2-2-1	General Specifications	36
2-2-2	DeviceNet Communications Specifications	38
2-2-3	EtherNet/IP Communications Specifications (Controllers That Support EtherNet/IP)	38
2-2-4	I/O Specifications	39

2-1 Nomenclature and Functions

This section describes the part names and functions of the NE1A-series Controllers.

2-1-1 Nomenclature

NE1A-SCPU01 (-V1)

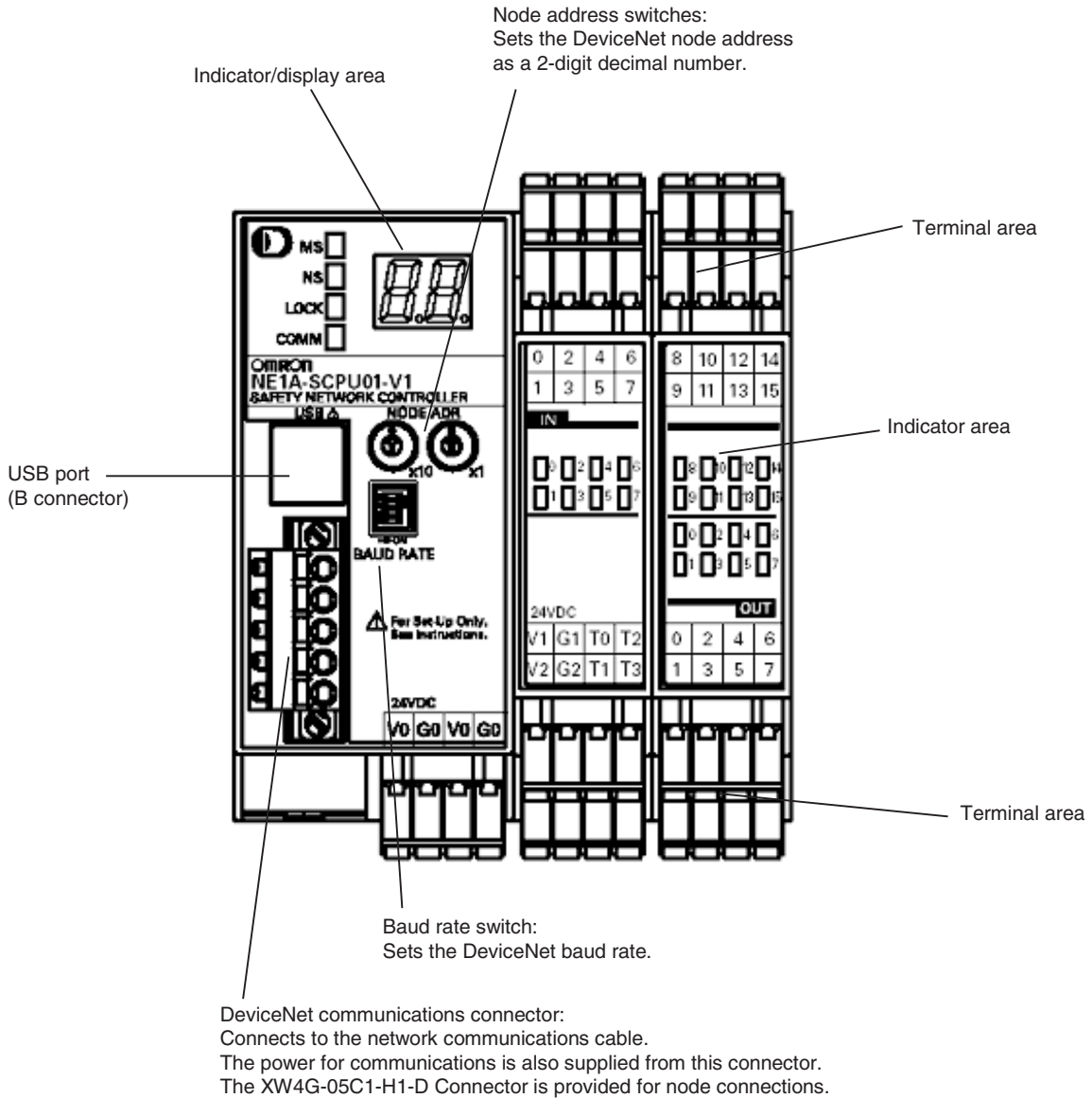

NE1A-SCPU02

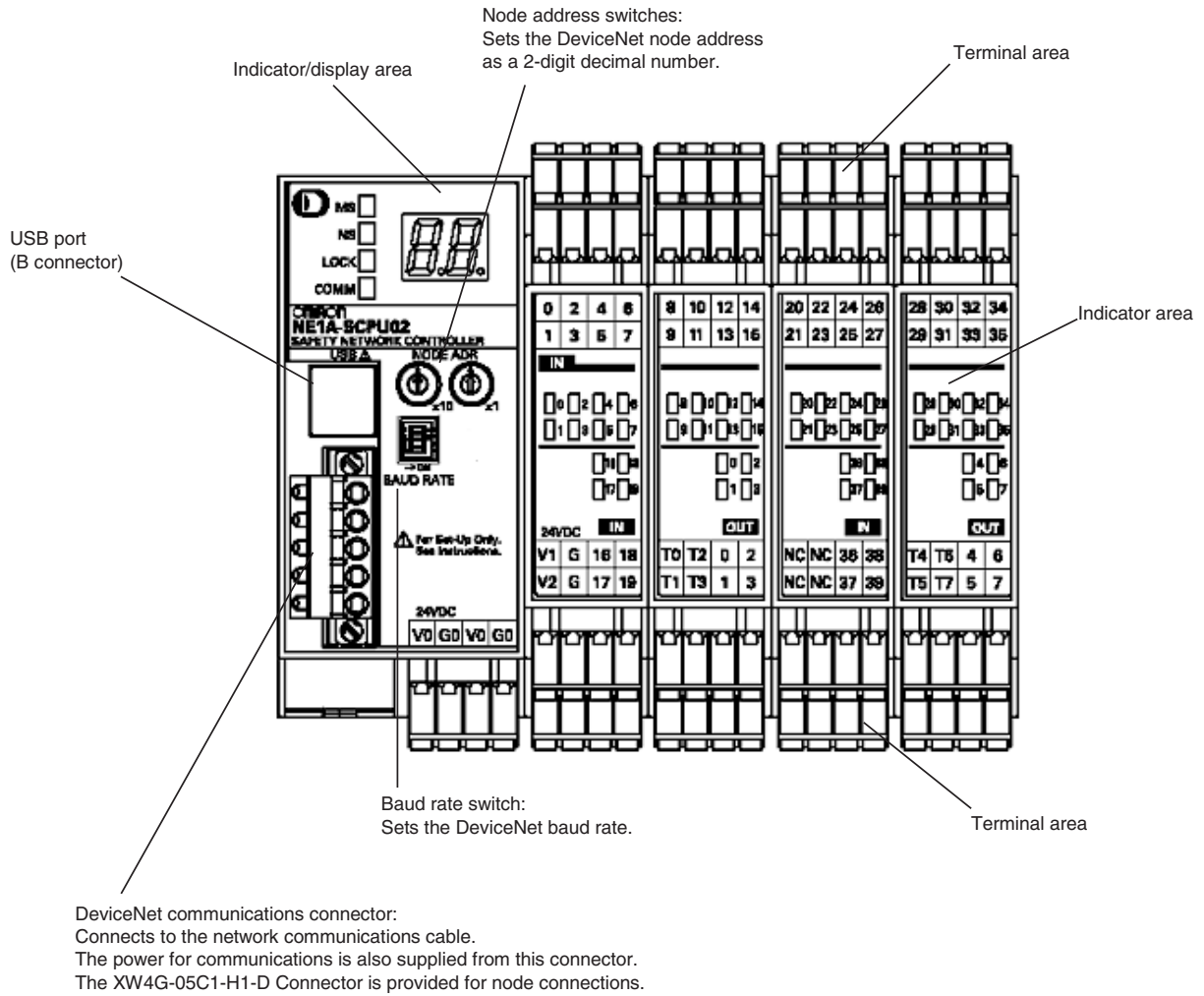

NE1A-SCPU01-EIP

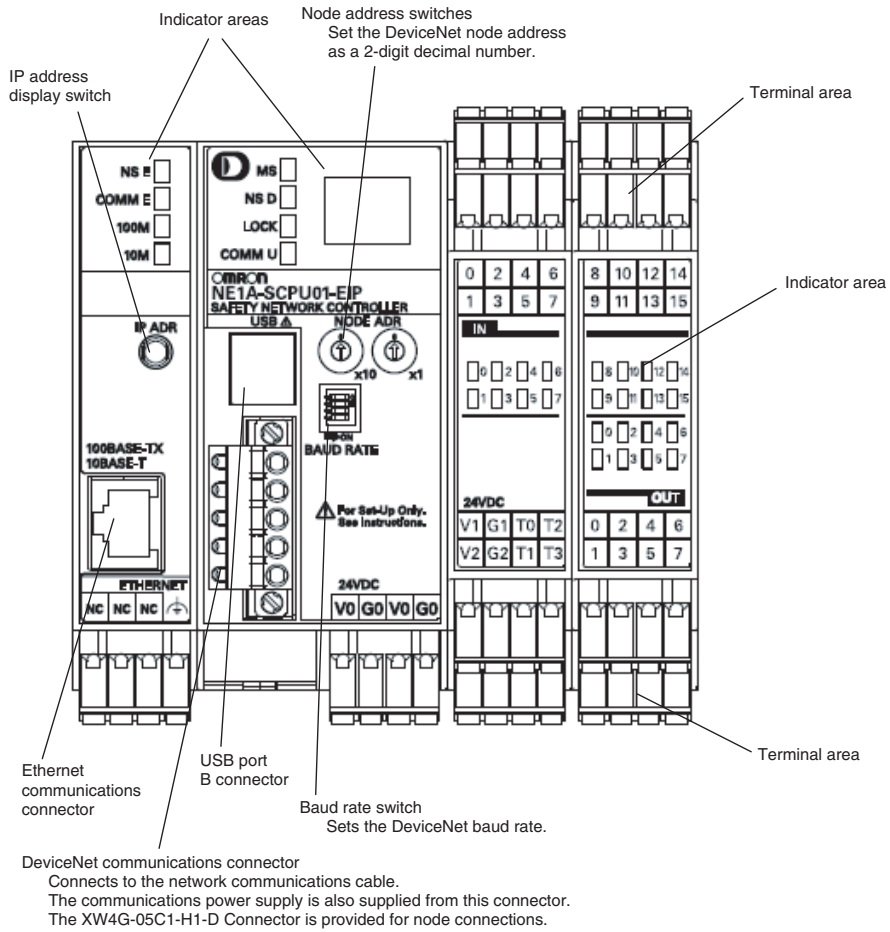

NE1A-SCPU02-EIP

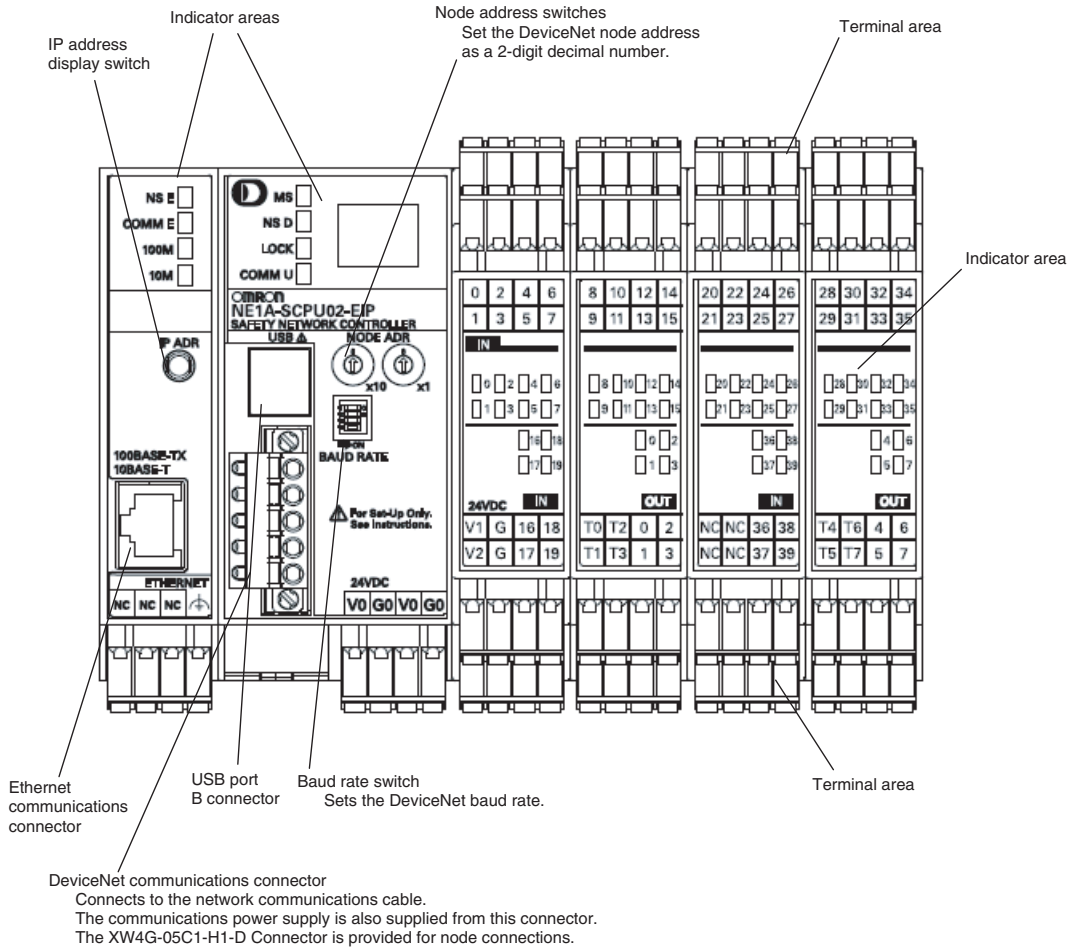











2-1-2 Indicator/Display Areas



Status Indicators

The following LED indicators show the status of the NE1A-series Controller, network, and I/O circuits.

- MS (module status)
- NS/NS D (DeviceNet network status)
- LOCK (configuration lock status)
- COMM/COMM U (USB communications status)
- IN 0 to 15 (local input status, NE1A-SCPU01(-V1))
- IN 0 to 39 (local input status, NE1A-SCPU02)
- OUT 0 to 7 (local output status)
- NS E (EtherNet/IP network status)
- COMM E (Ethernet communications status)
- 100M (100Base-TX link status)
- 10M (10Base-T link status)

Indicator name	Color	Status	Meaning
MS	Green		Operation status
			Idle status
	Red		Critical error status
			Abort status
	Green/red		Waiting for TUNID setting during self-diagnosis or waiting for configuration.
-		Power is not supplied.	
NS (NS D for Controllers that support EtherNet/IP)	Green		Online connection has been established.
			Online connection has not been established.
	Red		Unable to communicate.
			I/O communications error
	Green/red		Waiting for TUNID setting.
-		Not online or DeviceNet communications disabled (Standalone Mode).	
LOCK	Yellow		Lock has been completed with a valid configuration.
			Lock has not been completed with a valid configuration.
			No valid configuration data
COMM (COMM U for Controllers that support EtherNet/IP) (USB)	Yellow		Data transmission/reception in progress.
			No data transmission/reception in progress.
IN 0, 1, 2, ...15 OUT 0, 1, 2, ...7 (NE1A-SCPU01(-V1), NE1A-SCPU01-EIP) IN 0, 1, 2 ...39 OUT 0, 1, 2 ...7 (NE1A-SCPU02, NE1A- SCPU02-EIP)	Yellow		I/O signal is ON.
	Red		Error detected in I/O circuits. Discrepancy error has occurred in an input set for Dual Channel Mode.
			Dual channel violation has occurred in an output set for Dual Channel Mode.
			Error detected in the other I/O circuit set for Dual Channel Mode (no error in this I/O circuit).
-		I/O signal is OFF.	

Indicator name	Color	Status	Meaning
NS E	Green		Online connection has been established.
			Online connection has not been established.
	Red		Fatal communications error
			Non-fatal communications error
	-		Not online.
COMM E	Green		Data transmission/reception in progress.
			No data transmission/reception in progress.
100M	Red		Ethernet has established a 100Base-TX link.
			Ethernet has not established a 100Base-TX link.
10M	Red		Ethernet has established a 10Base-T link.
			Ethernet has not established a 10Base-T link.

 : ON  : Flashing  : OFF

Seven-segment Display

The 7-segment display indicates the NE1A-series Controller’s node address during normal conditions, and the error code and the node address of the error during error conditions. Also, “nd” is displayed during normal conditions if DeviceNet communications are disabled (i.e., Standalone Mode).

For Controllers that support EtherNet/IP, the error code “n4” is displayed if an error occurs in EtherNet/IP. In addition, the EtherNet/IP IP address can be displayed by pressing the IP address display switch.

Status		Display	
Normal conditions with DeviceNet enabled	Operating mode: RUN mode Safety I/O communications: Operating or not set.	Shows the NE1A-series Controller’s node address (00 to 63).	Lit
	Operating mode: RUN mode Safety I/O communications: Not operating		Flashing
	Operating mode: Self-testing, configuring, or idle		Flashing
Normal conditions with DeviceNet disabled	Operating mode: RUN mode	“nd”	Lit
	Operating mode: Self-testing, configuring, or idle		Flashing
Error conditions	Critical error	Indefinite	
	Abort	Only error code	Lit
	Nonfatal error	Only error code	Lit
		Alternates between displaying the error code and the node address where the error occurred.	

- IP Address Display Example: When the IP Address is 192.200.200.2 The IP address is displayed from right to left after the display type.
- Display Type: EtherNet/IP IP Address



- Display Type: EtherNet/IP IP Address when BOOTP is Set

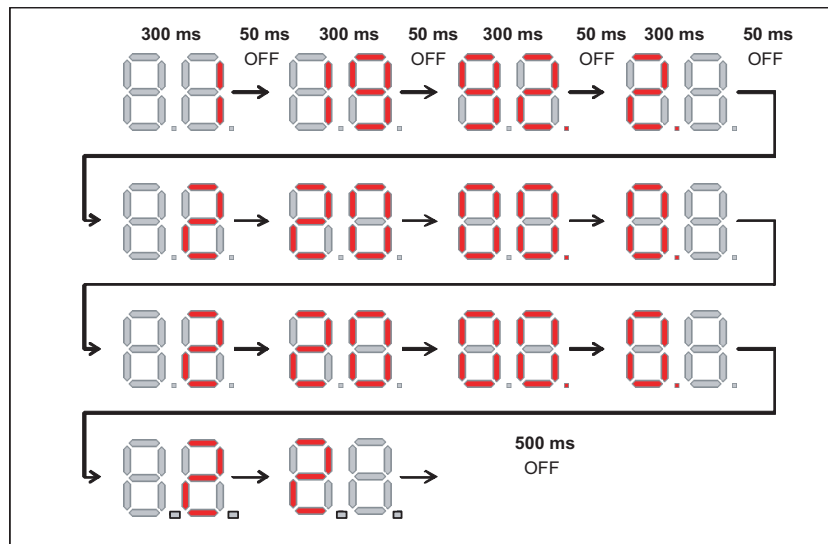

 **WARNING**

Serious injury may possibly occur due to loss of required safety functions.
Do not use the NE1A-series Controller's indicators for safety operations.



Note The errors are indicated by the combination of the MS indicator, NS indicator, and the 7-segment display. For further details on specific meanings, refer to *SECTION 12 Troubleshooting*.

2-1-3 Switch Settings

Node Address Switches

Set the DeviceNet node address using the rotary switches on the front of the NE1A-series Controller.



Method	Two-digit decimal number
Range	0 to 63

Note The node address is set to 63 at the factory.

Any node address in the setting range can be used as long as the same address is not used by another node. If a value between 64 and 99 is set on the rotary switches, the node address can be set using a software setting on the Network Configurator.

IMPORTANT

- Turn OFF power to the NE1A-series Controller before setting the rotary switches.
- Do not change the rotary switches while the power is ON. The Controller will detect this as a change in the configuration and will switch to ABORT State.
- A node address duplication error will occur if the same address is set for more than one node. Communications will not start if this error occurs.

Note

- Use a small flat-blade screwdriver to set the rotary switches, being careful not to scratch them.
- Refer to 4-1 Initial Setting for software setting procedures.

Baud Rate Switch

The DeviceNet baud rate is set using the DIP switch on the front of the NE1A-series Controller. The baud rate settings are shown in the following table:



Pin				Baud rate
1	2	3	4	
OFF	OFF	OFF	OFF	125 kbit/s
ON	OFF	OFF	OFF	250 kbit/s
OFF	ON	OFF	OFF	500 kbit/s
ON	ON	OFF	OFF	Software setting
ON or OFF	ON or OFF	ON	OFF	
ON or OFF	ON or OFF	ON or OFF	ON	Automatic baud rate detection

Note The baud rate is set to 125 kbit/s at the factory.

Note Refer to 4-1 Initial Setting for software setting procedures.

IP Address Display Switch (Only Controllers that Support EtherNet/IP)

Press the IP address display switch for 1 second or longer to display at the 7-segment display the EtherNet/IP IP address that is set.

For details, refer to the information on the 7-segment display in *2-1-2 Indicator/Display Areas*.



2-1-4 DeviceNet Communications Connector

Stickers are placed on the communication connectors based on the color of each communications wire. By matching the communications wire colors with the unit sticker colors, you can check to see if wires are in the correct locations. The colors of the wires are as follows:

Color	Description
Red	V+
White	Signal (CAN H)
-	(SHIELD)
Blue	Signal (CAN L)
Black	V-

Refer to the *DeviceNet User's Manual (W379)* for details on communications specifications and wiring.

IMPORTANT Turn OFF the power supply to the NE1A-series Controller and all nodes on the network before starting any wiring operations.

2-1-5 USB Communications Connector

Connect the USB communications connector with a computer when a Network Configurator is to be used. The NE1A-series Controllers support the USB version 1.1 standard. Use a commercially available USB-A to USB-B Male/Male cable for the connection.

2-1-6 Ethernet Connector

The Ethernet connector is used to connect Ethernet twisted-pair cable.

- Electrical characteristics: Conforms to IEEE 802.3 specifications.
- Connector structure: RJ45 8-pin modular connector (Conforms to ISO 8877.)

2-1-7 Input/Output Terminals and Internal Connections

NE1A-SCPU01(-V1)

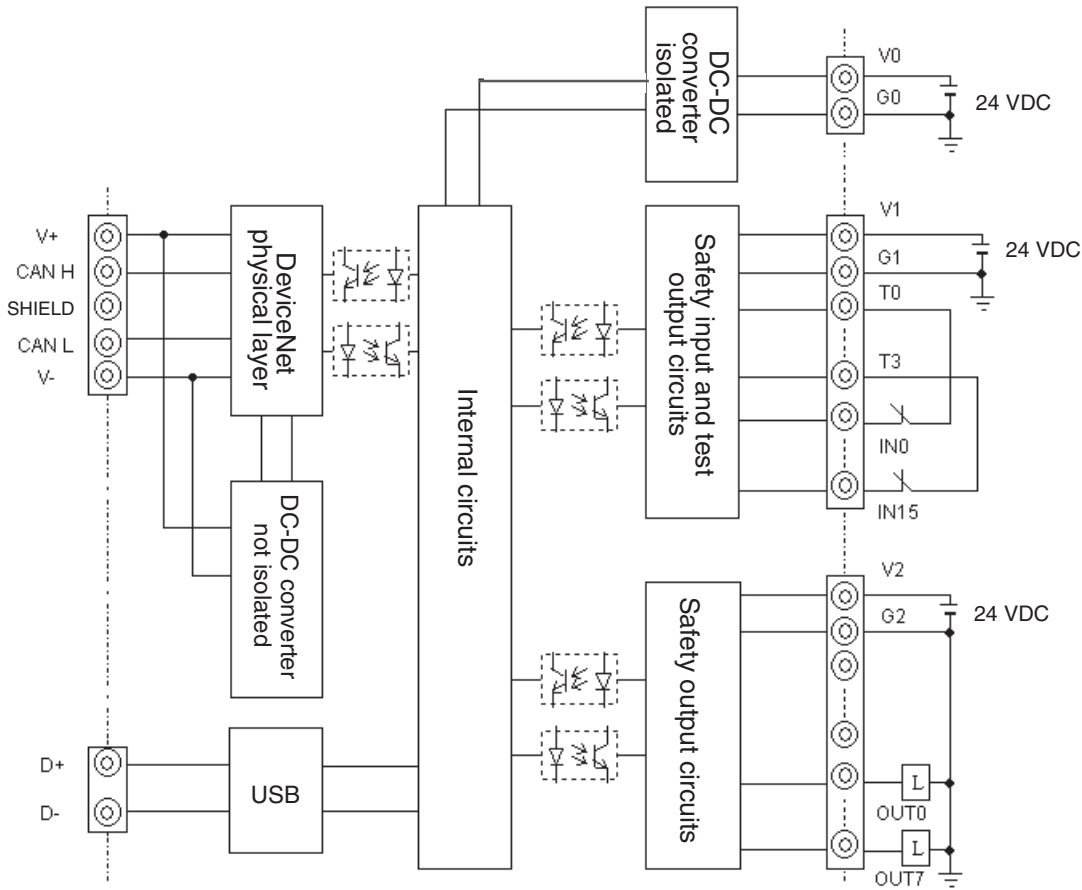

Terminal name	Description
V0	Power supply terminal for internal circuits The two V0 terminals are connected internally.
G0	Power supply terminal for internal circuits The two G0 terminals are connected internally.
V1	Power supply terminal for external input devices and test outputs
G1	Power supply terminal for external input devices and test outputs
V2	Power supply terminal for external output devices
G2	Power supply terminal for external output devices
IN0 to IN15	Safety input terminals
T0 to T3	Test output terminals used to connect with safety inputs IN0 to IN15. Each test output terminal outputs a different test pulse pattern. Terminal T3 also supports a current monitoring function for the output signal, for example, for a muting lamp.
OUT0 to OUT7	Safety output terminals

NE1A-SCPU02

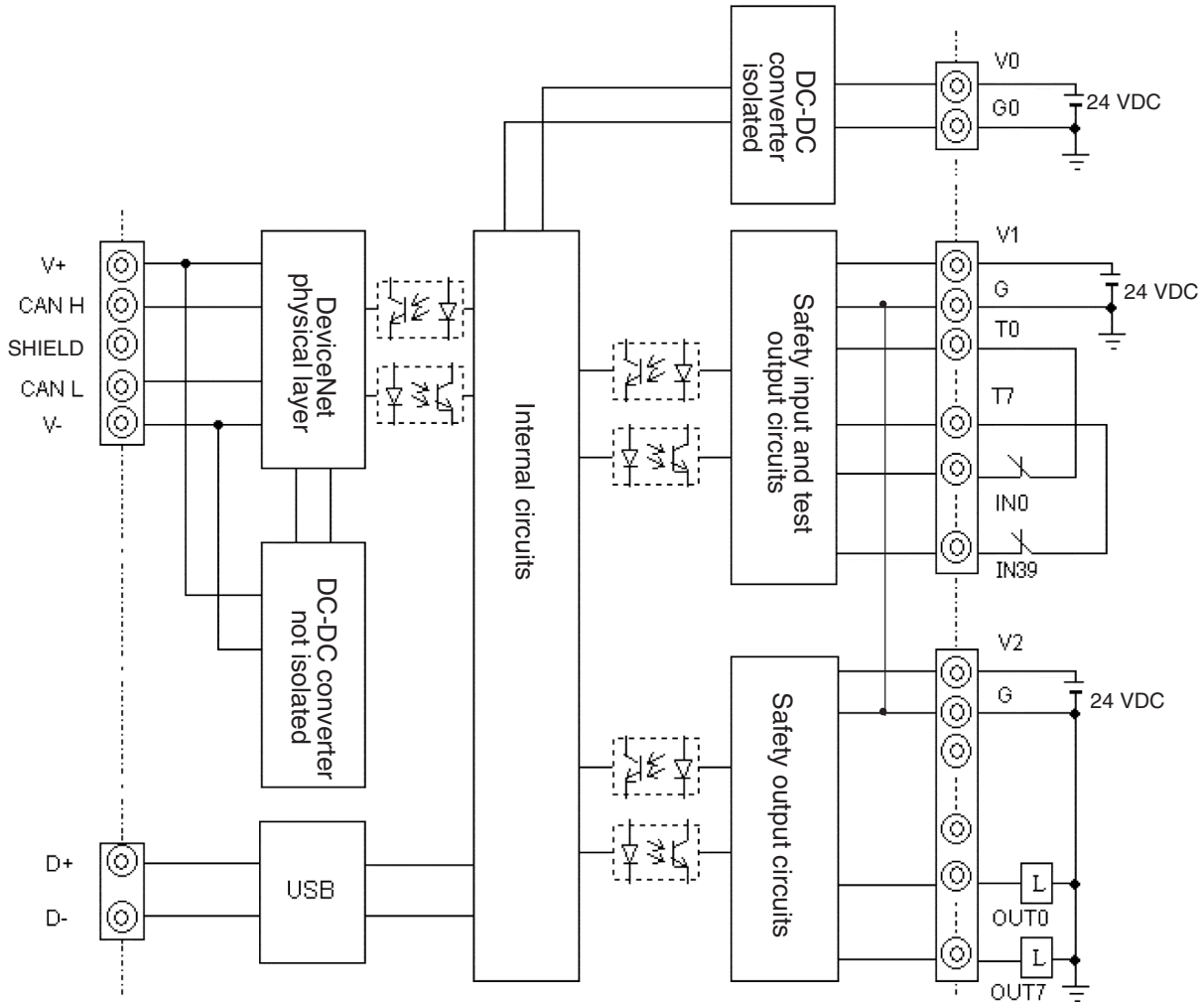

Terminal name	Description
V0	Power supply terminal for internal circuits The two V0 terminals are connected internally.
G0	Power supply terminal for internal circuits The two G0 terminals are connected internally.
V1	Power supply terminal for external input devices and test outputs
G	Power supply terminal for external input devices and test outputs
V2	Power supply terminal for external output devices
G	Power supply terminal for external output devices
IN0 to IN39	Safety input terminals
T0 to T3	Test output terminals used to connect with safety inputs IN0 to IN19. Each test output terminal outputs a different test pulse pattern. Terminal T3 also supports a current monitoring function for the output signal, for example, for a muting lamp.
T4 to T7	Test output terminals used to connect with safety inputs IN20 to IN39. Each test output terminal outputs a different test pulse pattern. Terminal T7 also supports a current monitoring function for the output signal, for example, for a muting lamp.
OUT0 to OUT7	Safety output terminals

NE1A-SCPU01-EIP

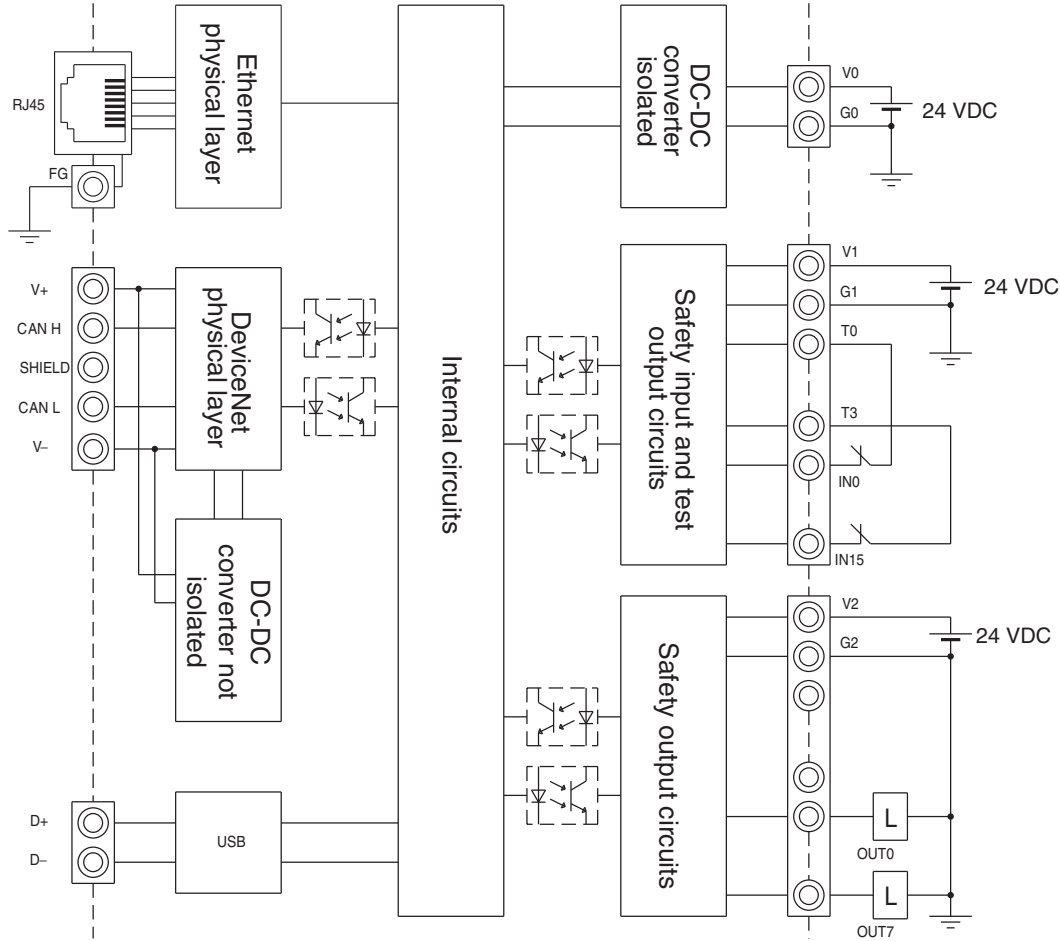

Terminal name	Description
V0	Power supply terminal for internal circuits The two V0 terminals are connected internally.
G0	Power supply terminal for internal circuits The two G0 terminals are connected internally.
V1	Power supply terminal for external input devices and test outputs
G1	Power supply terminal for external input devices and test outputs
V2	Power supply terminal for external output devices
G2	Power supply terminal for external output devices
IN0 to IN15	Safety input terminals
T0 to T3	Test output terminals used to connect with safety inputs IN0 to IN15. Each test output terminal outputs a different test pulse pattern. Terminal T3 also supports a current monitoring function for the output signal, for example, for a muting lamp.
OUT0 to OUT7	Safety input terminals

NE1A-SCPU02-EIP

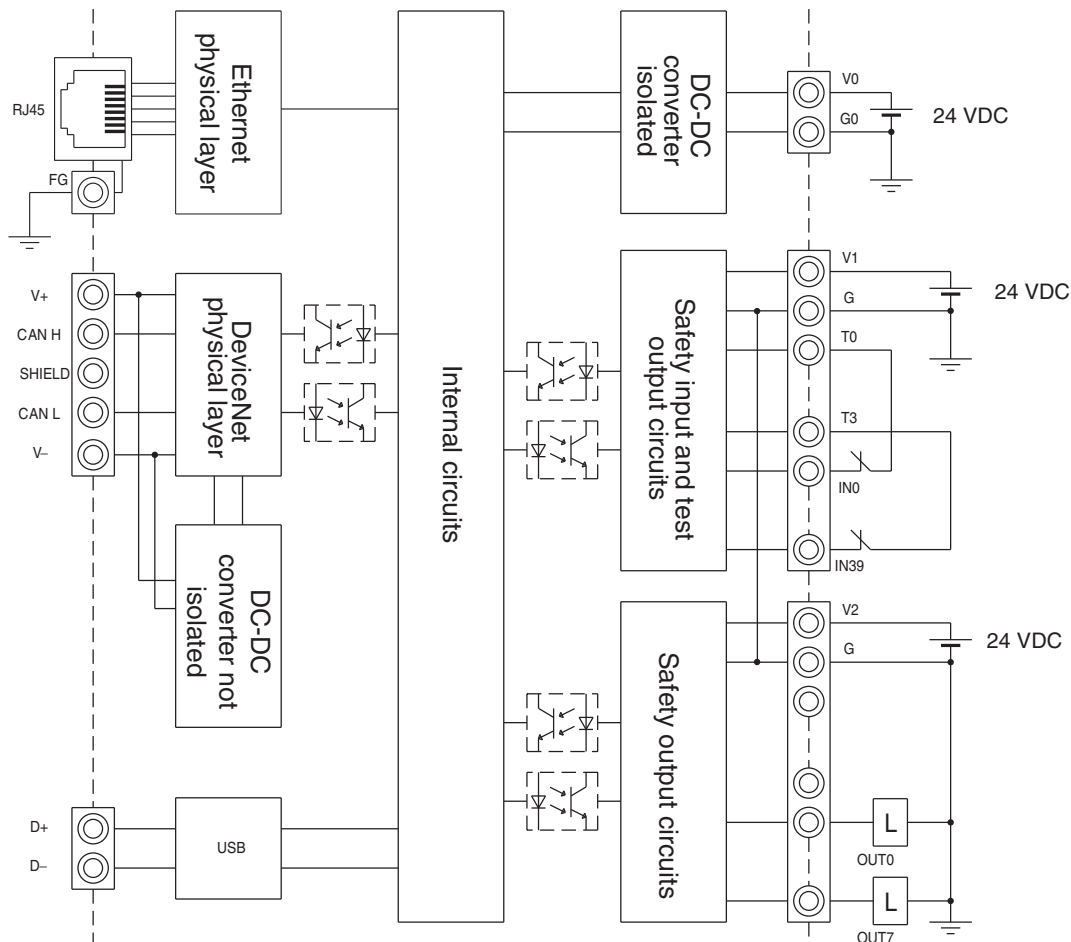

Terminal name	Description
V0	Power supply terminal for internal circuits The two V0 terminals are connected internally.
G0	Power supply terminal for internal circuits The two G0 terminals are connected internally.
V1	Power supply terminal for external input devices and test outputs
G	Power supply terminal for external input devices and test outputs
V2	Power supply terminal for external output devices
G	Power supply terminal for external output devices
IN0 to IN39	Safety input terminals
T0 to T3	Test output terminals used to connect with safety inputs IN0 to IN19. Each test output terminal outputs a different test pulse pattern. Terminal T3 also supports a current monitoring function for the output signal, for example, for a muting lamp.
T4 to T7	Test output terminals used to connect with safety inputs IN20 to IN39. Each test output terminal outputs a different test pulse pattern. Terminal T7 also supports a current monitoring function for the output signal, for example, for a muting lamp.
OUT0 to OUT7	Safety input terminals

2-2 Specifications

This section provides the NE1A-series Controller's specifications.

2-2-1 General Specifications

NE1A-SCPU01(-V1), NE1A-SCPU01-EIP

Item		Specifications
DeviceNet supply voltage		11 to 25 VDC (Supplied from communications connector.)
Device supply voltage V0 (See note 1.)		20.4 to 26.4 VDC (24 VDC, -15% to 10%)
I/O supply voltages V1 and V2 (See note 1.)		20.4 to 26.4 VDC (24 VDC, -15% to 10%)
Current consumption	DeviceNet	15 mA at 24 VDC
	Internal logic circuits	230 mA at 24 VDC (NE1A-SCPU01-EIP: 280 mA)
	I/O power supply (See note 2.)	40 mA at 24 VDC for inputs and 120 mA at 24 VDC for outputs
Overvoltage category		II (according to IEC 61131-2: 4.4.2)
EMC		Compliant with IEC 61131-2.
Vibration resistance		0.35 mm at 10 to 57 Hz, 50 m/s ² at 57 to 150 Hz
Shock resistance		150 m/s ² for 11 ms
Mounting		DIN Track (TH35-7.5/TH35-15 according to IEC 60715)
Operating temperature		-10 to 55°C
Humidity		10% to 95% (with no condensation)
Storage temperature		-40 to 70°C
Degree of protection		IP20
Serial interface		USB Ver. 1.1
Weight		460 g max. (NE1A-SCPU01-EIP: 570 g max.)

- Note**
- (1) V0 to G0: For internal logic circuits, V1 to G1: For external input devices and test outputs, V2 to G2: For external output devices.
 - (2) The current consumption of external devices is not included.

NE1A-SCPU02, NE1A-SCPU02-EIP

Item		Specifications
DeviceNet supply voltage		11 to 25 VDC (Supplied from communications connector.)
Device supply voltage V0 (See note 1.)		20.4 to 26.4 VDC (24 VDC, -15% to 10%)
I/O supply voltages V1 and V2 (See note 1.)		20.4 to 26.4 VDC (24 VDC, -15% to 10%)
Current consumption	DeviceNet	15 mA at 24 VDC
	Internal logic circuits	280 mA at 24 VDC (NE1A-SCPU02-EIP: 330 mA)
	I/O power supply (See note 2.)	80 mA at 24 VDC for inputs and 150 mA at 24 VDC for outputs
Overvoltage category		II (according to IEC 61131-2: 4.4.2)
EMC		Compliant with IEC 61131-2.
Vibration resistance		0.35 mm at 10 to 57 Hz, 50 m/s ² at 57 to 150 Hz
Shock resistance		150 m/s ² for 11 ms
Mounting		DIN Track (TH35-7.5/TH35-15 according to IEC 60715)
Operating temperature		-10 to 55°C
Humidity		10% to 95% (with no condensation)
Storage temperature		-40 to 70°C
Degree of protection		IP20
Serial interface		USB Ver. 1.1
Weight		690 g max. (NE1A-SCPU02-EIP: 800 g max.)

- Note**
- (1) V0 to G0: For internal logic circuits, V1 to G: For external input devices and test outputs, V2 to G: For external output devices.
G or V1 and G of V2 are connected internally.
- (2) The current consumption of external devices is not included.

2-2-2 DeviceNet Communications Specifications

Item	Specifications			
Communications protocol	Conforms to DeviceNet.			
Connection method	The multidrop and T-branch connections can be combined (for main line and branch lines).			
Baud rate	500 kbits/s, 250 kbits/s, 125 kbits/s			
Communications medium	Special cable with 5 lines (2 communications lines, 2 power lines, 1 shield line)			
Communications distance	Baud rate	Maximum network length	Branch length	Total length
	500 kbits/s	100 m max. (100 m max.)	6 m max.	39 m max.
	250 kbits/s	250 m max. (100 m max.)	6 m max.	78 m max.
	125 kbits/s	500 m max. (100 m max.)	6 m max.	156 m max.
	The numbers in parentheses are the lengths when Thin Cable is used.			
Communications power supply	11 to 25 VDC			
Connected nodes	63 nodes max.			
Safety I/O communications (Pre-Ver. 1.0 Controllers)	Safety Master Function: <ul style="list-style-type: none"> • Maximum number of connections: 16 • Maximum data size: 16 bytes input or 16 bytes output (per connector) • Connection type: Single-Cast, Multicast Safety Slave Function: <ul style="list-style-type: none"> • Maximum number of connections: 4 • Maximum data size: 16 bytes input or 16 bytes output (per connector) • Connection type: Single-Cast, Multicast 			
Safety I/O communications (Controllers with unit version 1.0 or later) (including Controllers that support EtherNet/IP)	Safety Master Function: <ul style="list-style-type: none"> • Maximum number of connections: 32 • Maximum data size: 16 bytes input or 16 bytes output (per connector) • Connection type: Single-Cast, Multicast Safety Slave Function: <ul style="list-style-type: none"> • Maximum number of connections: 4 • Maximum data size: 16 bytes input or 16 bytes output (per connector) • Connection type: Single-Cast, Multicast 			
Standard I/O communications	Standard Slave Function <ul style="list-style-type: none"> • Maximum number of connections: 2 • Maximum data size: 16 bytes input and/or 16 bytes output (per connector) • Connection type: Poll, Bit-strobe, COS, Cyclic 			
Message communications	Maximum message length: 552 bytes			

2-2-3 EtherNet/IP Communications Specifications (Controllers That Support EtherNet/IP)

Item	Specifications
Media access method	CSMA/CD
Modulation method	Baseband
Transmission path type	Star topology
Baud rate	10Base-T: 10 Mbits/s 100Base-TX: 100 Mbits/s
Transmission medium	Twisted-pair cable (shielded: STP): Category 5, 5e
Transmission distance	100 m (distance between hub and nodes)
Number of cascade connections	There is no limit when a switching hub is used.

Item	Specifications
Number of CIP connections	2 (Class 1 connection) Maximum data size: 128 input bytes or 16 output bytes per connection Connection type: Point-to-point or multicast
Allowable Unit communications bandwidth	3,000 pps (See note.)
Explicit message communications	Maximum message length for class 3 connection: 502 bytes Maximum message length for UCMM connection: 502 bytes Number of connections: 4 total for Class 3 and UCMM
UDP/IP Message Communications Specifications	Number of resources: 4 message buffers for server and no message buffers for client Maximum message size: 492 bytes for commands and 496 bytes for responses UDP port number: Always 64000 (FA00 hex)

Note “pps” means “packets per second.” It indicates the number of send or receive packets that can be processed per second.

2-2-4 I/O Specifications

Safety Inputs

Item	Specifications
Input type	Current sinking (PNP)
ON voltage	11 VDC min. between each input terminal and G
OFF voltage	5 VDC max. between each input terminal and G
OFF current	1 mA max.
Input current	4.5 mA

Safety Outputs

Item	Specifications
Output type	Current sourcing (PNP)
Rated output current	0.5 A per output
Residual voltage	1.2 V max. between each output terminal and V2
Leakage current	0.1 mA max.

IMPORTANT If a safety output is set as a *safety pulse output*, an OFF pulse signal (pulse width: 580 μs) will be output to diagnose the output circuit when the safety output turns ON. Check the input response time of the control device connected to the NE1A-series Controller to be sure that this output pulse will not cause malfunctions.

Test Outputs

Item	Specifications
Output type	Current sourcing (PNP)
Rated output current	0.7 A max. per output (See notes 1 and 2.)
Residual voltage	1.2 V max. between each output terminal and V1
Leakage current	0.1 mA max.

Note

- (1) Total simultaneous current: 1.4 A max.
(T0 to T3: NE1A-SCPU01(-V1)/NE1A-SCPU01-EIP, T0 to T7: NE1A-SCPU02/NE1A-SCPU02-EIP)
- (2) Connectable external indicator (T3: NE1A-SCPU01(-V1)/NE1A-SCPU01-EIP, T3 and T7: NE1A-SCPU02/NE1A-SCPU02-EIP: 24 VDC, 15 to 400 mA)

SECTION 3

Installation and Wiring

3-1	Installation	42
3-1-1	Requirements for Installation and Wiring	42
3-1-2	Mounting to the Control Panel	43
3-1-3	Dimensions and Weight	47
3-2	Wiring	51
3-2-1	General Instructions on Wiring	51
3-2-2	Wiring the Power Supply and I/O Lines	52
3-2-3	Wiring I/O Devices	54
3-2-4	DeviceNet Wiring	64
3-2-5	Wiring the USB Connector	64
3-2-6	Ethernet (EtherNet/IP) Network Installation	65

3-1 Installation

3-1-1 Requirements for Installation and Wiring

Consider the following for installation and wiring to improve the reliability of the NE1A-series Safety Network Controller System and to fully exploit the system's capabilities.

Installation and Storage Environment

Do not use or store the NE1A-series Controller in any of the following locations.

- Locations subject to direct sunlight
- Locations subject to temperatures or humidity outside the ranges specified in the specifications
- Locations subject to condensation as the result of severe changes in temperature
- Locations subject to corrosive or flammable gases
- Locations subject to dust (especially iron dust) or salts
- Locations subject to water, oil, or chemicals
- Locations subject to shock or vibration

Take appropriate and sufficient measures when installing systems in the following locations. Inappropriate and insufficient measures may result in malfunction.

- Locations subject to static electricity or other forms of noise
- Locations subject to strong electromagnetic fields
- Locations subject to possible exposure to radioactivity
- Locations close to power supplies

3-1-2 Mounting to the Control Panel

- Use the NE1A-series Controller in an enclosure with IP54 protection or higher according to IEC/EN 60529.
- Use DIN Track (TH35-7.5/TH35-15 according to IEC 60715) to mount the NE1A-series Controller in the control panel. Mount the Controller to the DIN Track using PFP-M End Plates (not included with the NE1A-series Controller) to prevent it from falling off the DIN Track because of vibration.
- Provide sufficient space around the NE1A-series Controller, at least 5 mm at the sides and at least 50 mm at the top and bottom, for ventilation and wiring.

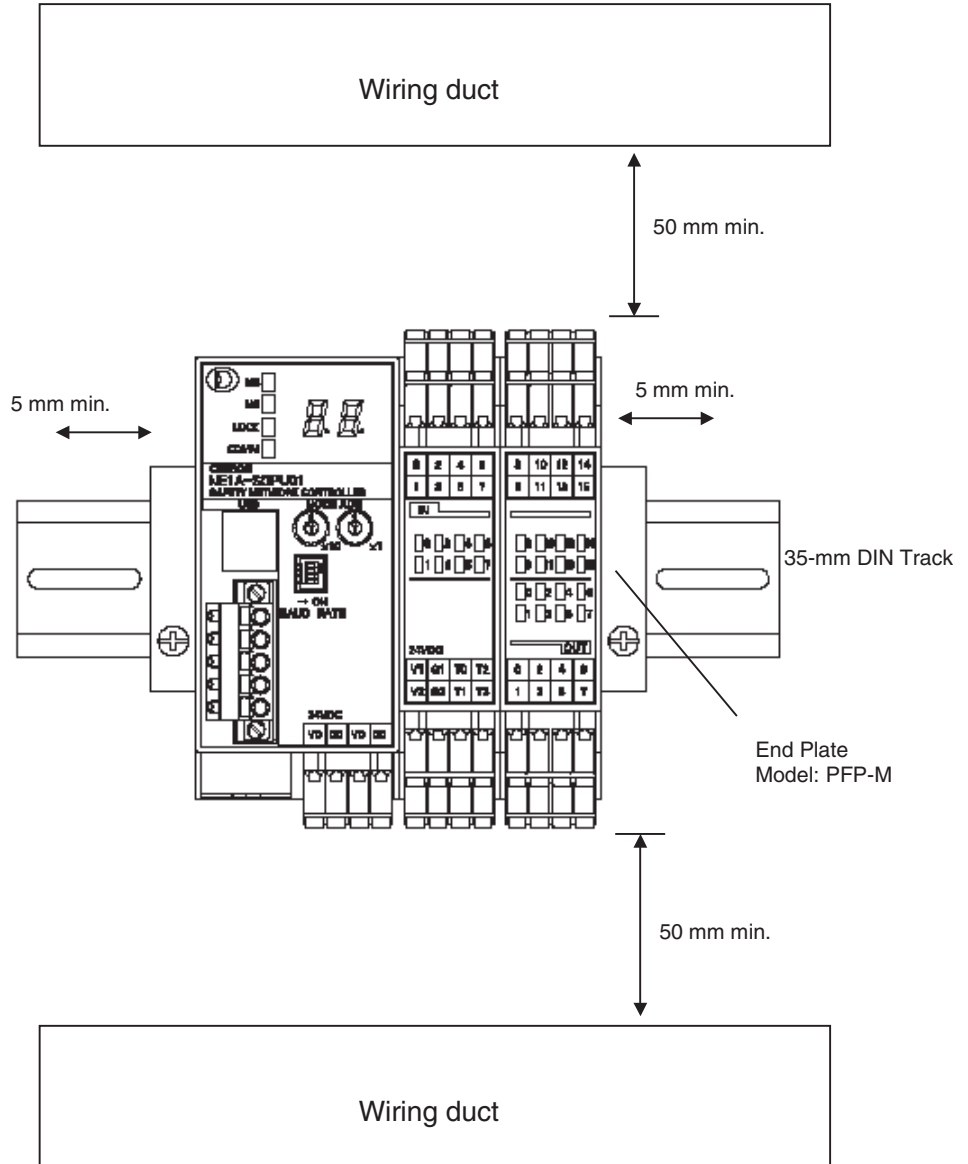

Note The NE1A-series Controller can be mounted only to DIN Track. Do not screw the Controller to the control panel.

Mounting

To ensure proper ventilation, mount the NE1A-series Controller as shown in the following diagram.

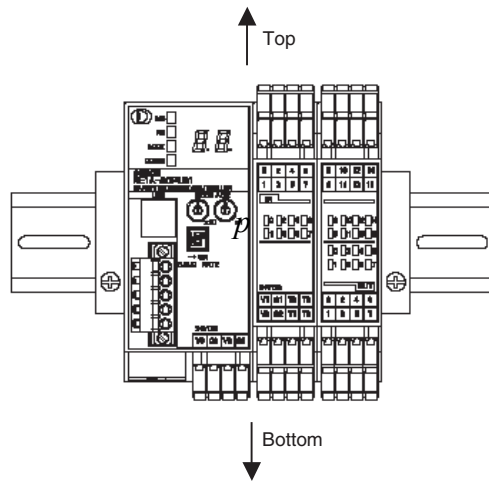

Do not mount the NE1A-series Controller as in the following diagrams.

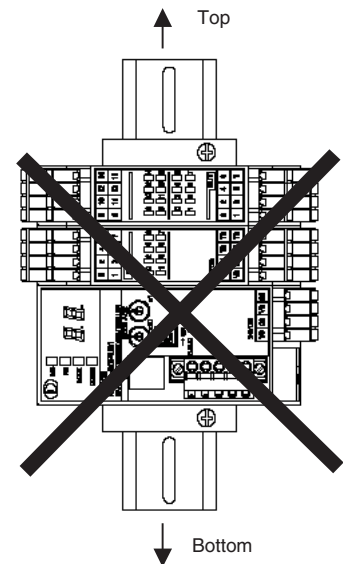
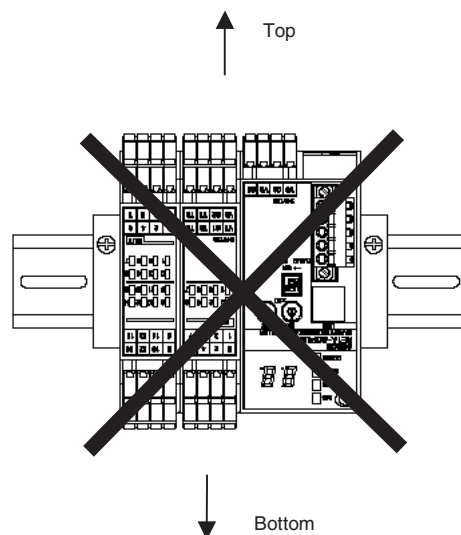
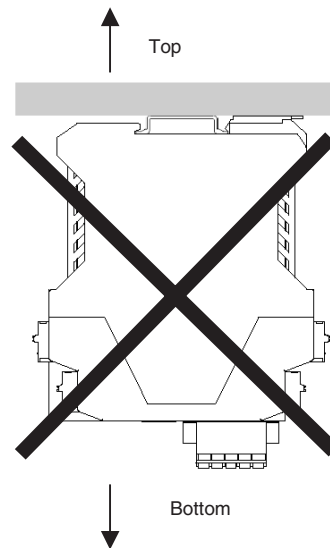
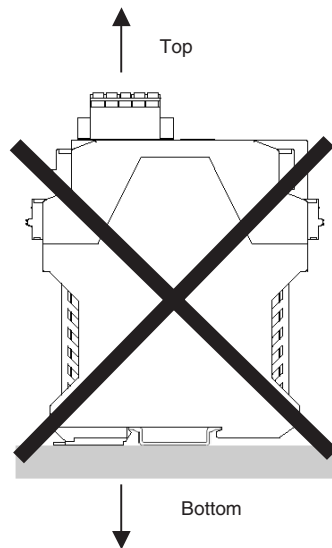

■ **DIN Track Mounting Bracket Position for the NE1A-SCPU01(-V1)**

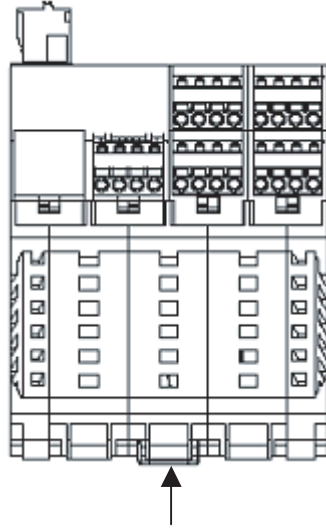

DIN Track Mounting Bracket

■ **DIN Track Mounting Bracket Position for the NE1A-SCPU02**

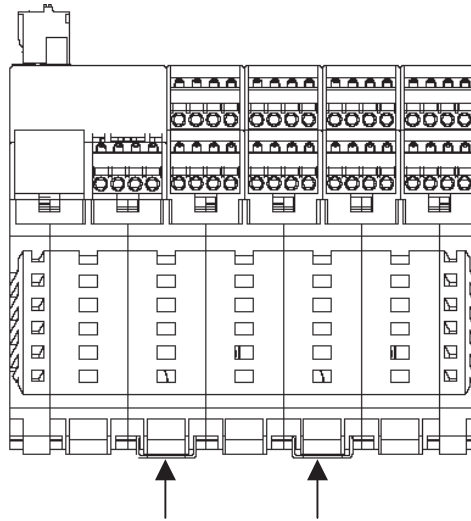

DIN Track Mounting Brackets

■ **DIN Track Mounting Bracket Position for the NE1A-SCPU01-EIP**

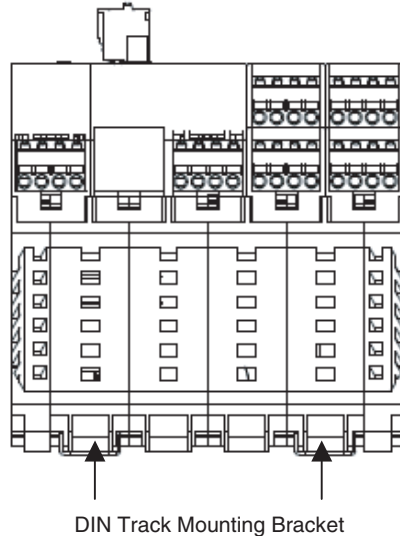

■ **DIN Track Mounting Bracket Position for the NE1A-SCPU02-EIP**

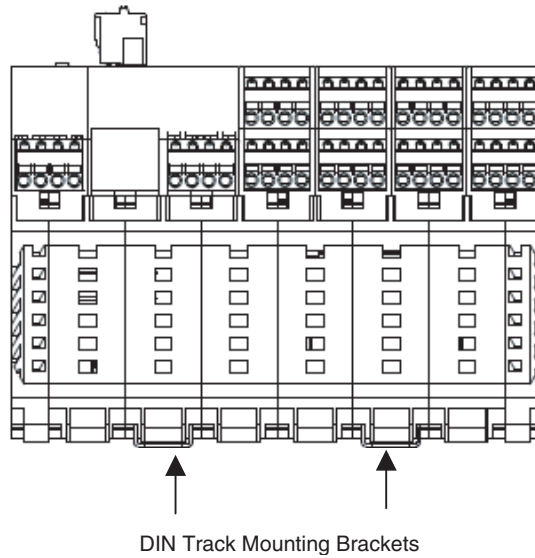

3-1-3 Dimensions and Weight

Dimensions

■ **NE1A-SCPU01(-V1)**

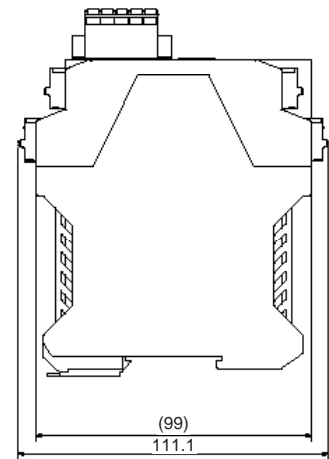
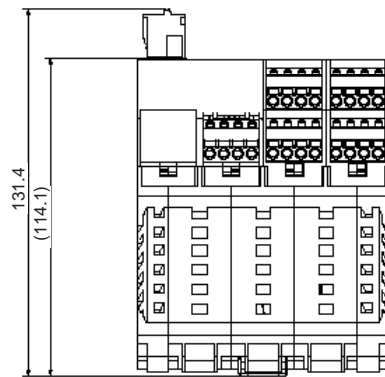
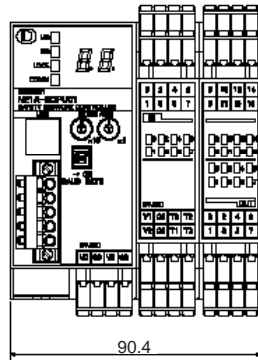

■ NE1A-SCPU02

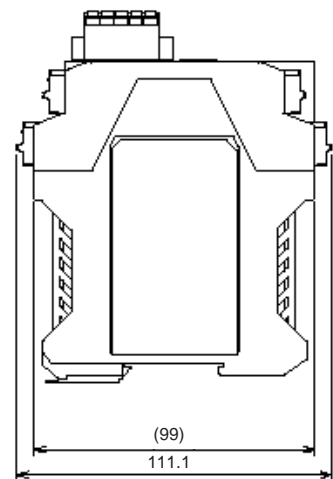
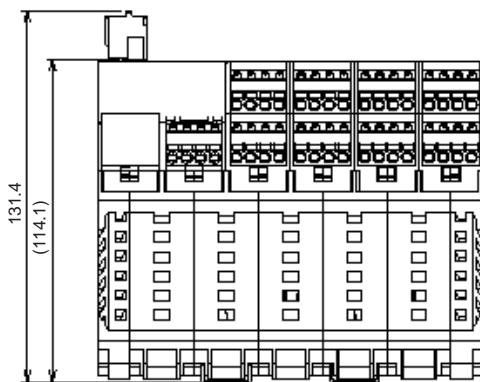
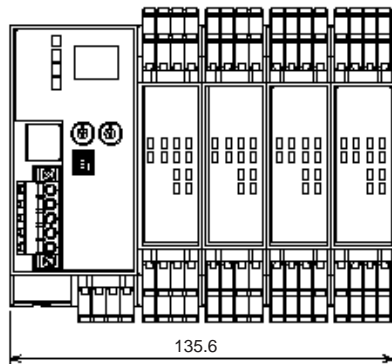

■ NE1A-SCPU01-EIP

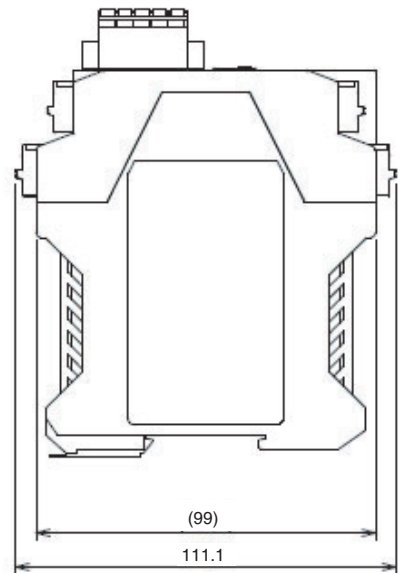
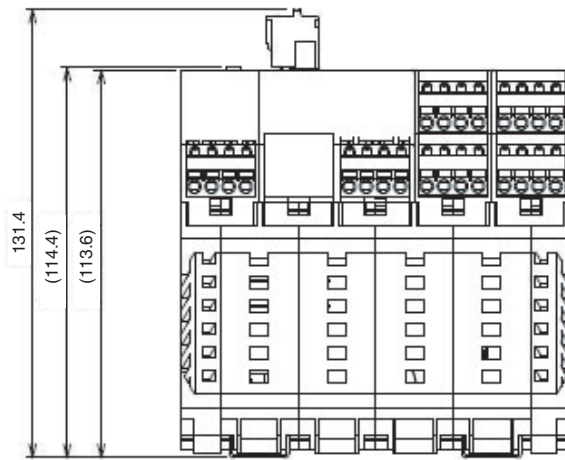
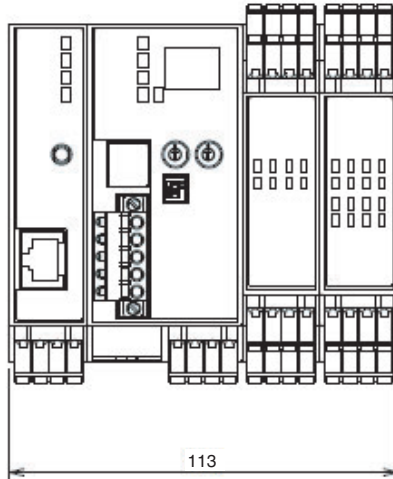

■ NE1A-SCPU02-EIP

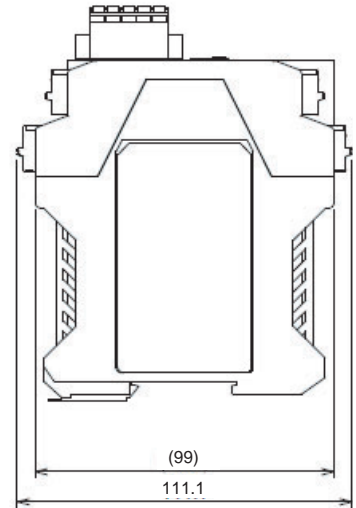
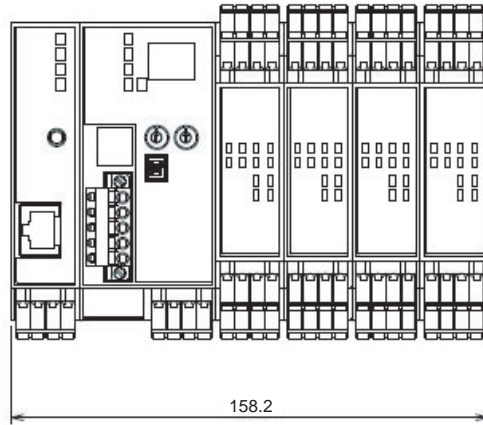

Weight

Model	Weight
NE1A-SCPU01(-V1)	460 g max.
NE1A-SCPU02	690 g max.
NE1A-SCPU01-EIP	570 g max.
NE1A-SCPU02-EIP	800 g max.

3-2 Wiring

3-2-1 General Instructions on Wiring

Precaution:

- To prevent wire clippings from getting into the NE1A-series Controller, do not remove the label on the Controller before wiring has been completed.
- After wiring has been completed, be sure to remove the label from the Controller to enable heat dissipation for proper cooling.

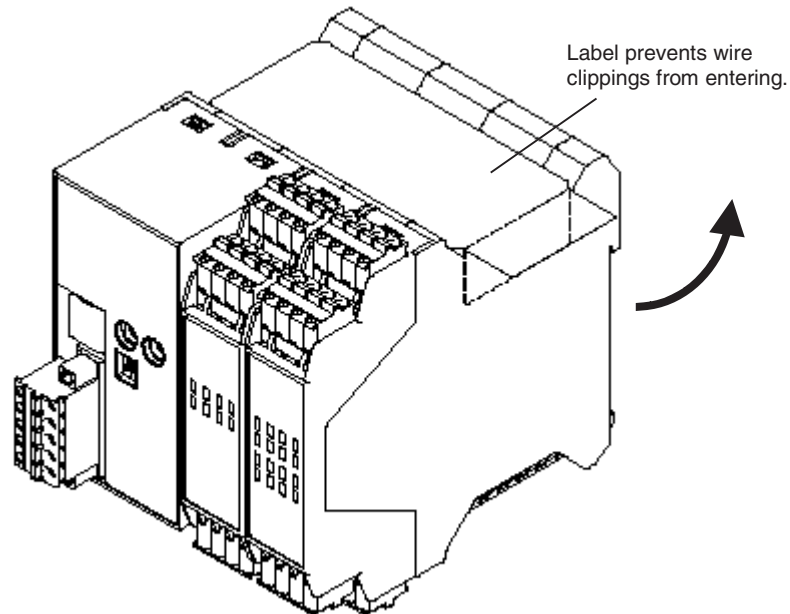

- Disconnect the NE1A-series Controller from the power supply before starting any wiring operations. Devices connected to the Controller may operate unexpectedly if wiring is performed with the power supply connected.
- Be careful not to get your fingers caught when attaching connectors to the plugs on the NE1A-series Controller.

⚠ WARNING

Serious injury may possibly occur due to loss of required safety functions. Wire the conductors correctly and verify the operation of the NE1A-series Controller before using the Controller system in actual operation.



3-2-2 Wiring the Power Supply and I/O Lines

Wire Sizes

Use the following wires to connect external I/O devices to the NE1A-series Controller.

Solid wire	0.2 to 2.5 mm ² (AWG 24 to AWG 12)
Stranded (flexible) wire	0.34 to 1.5 mm ² (AWG 22 to AWG 16)

Recommended Materials and Tools

■ Insulated Pin Terminals

Use a pin terminal with an insulated cover compliant with the DIN 46228-4 standard. Pin terminals similar in appearance but not compliant with the standard may not match the terminal block on the NE1A-series Controller. (The wiring dimensions are rough standards. Confirm the dimensions beforehand.) Use wires of the same diameter if two-wire pin terminals are used.

- Note**
- When wiring with pin terminals, be sure to insert pin terminals all the way into the terminal block.
 - When using two-wire pin terminals, use wires of the same diameter.
 - When using two-wire pin terminals, insert the pin terminal so that metal portion of the pin terminal is inserted straight into the terminal block, i.e., so that the long sides of the insulating cover are vertical.

Reference Specifications (Product Specifications for Phoenix Contact)

Model of pin terminal		Wire dimensions		Pin terminal specifications					Dimensions
		Cross-sectional area of conductor (mm ²)	AWG	Stripped length of insulation (mm)	Overall length L1 (mm)	Length of metal part L2 (mm)	Inner diameter of conductor D1 (mm)	Inner diameter of insulative cover D2 (mm)	
One-wire pin terminals	Al 0,34-8TQ	0.34	22	10	12.5	8	0.8	2.0	*1
	Al 0,5-10WH	0.5	20	10	16	10	1.1	2.5	
	Al 0,75-10GY	0.75	18	10	16	10	1.3	2.8	
	Al 1-10RD	1.0	18	10	16	10	1.5	3.0	
	Al 1,5-10BK	1.5	16	10	18	10	1.8	3.4	
Two-wire pin terminals	Al-TWIN 2 x 0,75-10GY	2 x 0.75	–	10	17	10	1.8	2.8/5.0	*2
	Al-TWIN 2 x 1-10RD	2 x 1	–	10	17	10	2.05	3.4/5.4	

*1: One-wire Pin Terminal

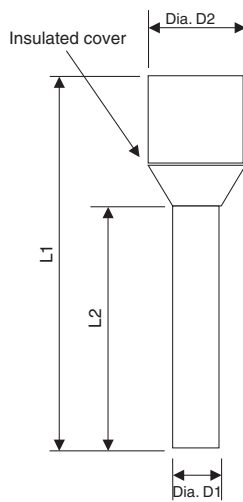

*2: Two-wire Pin Terminal

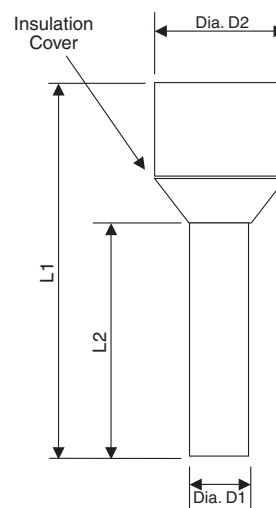

■ Terminal Crimping Tool

Manufacturer	Model
Phoenix Contact	CRIMPFOX UD6 or CRIMPFOX ZA3

Power Supply Selection

Use a DC power supply satisfying the following requirements.

- The secondary circuits of the DC power supply must be isolated from the primary circuit by double insulation or reinforced insulation.
- The DC power supply must satisfy the requirements for class 2 circuits or limited voltage/current circuits defined in UL 508.
- The output hold time must be 20 ms or longer.

3-2-3 Wiring I/O Devices

Wiring Input Devices

Refer to the following information for input device selection and wiring.

■ Devices with Mechanical Contact Outputs

Examples: Emergency stop buttons and safety limit switches

These devices use both a safety input terminal and test output terminal. A safety input terminal inputs the test output signal (pulse output) of the NE1A-series Controller via a contact output device.

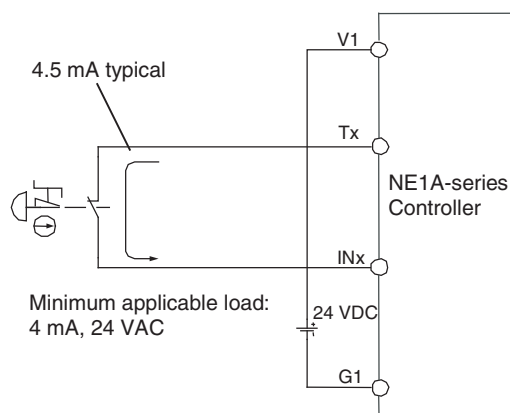

■ Devices with PNP Semiconductor Outputs (Current Sourcing)

Example: Light curtains

A PNP semiconductor output signal from this type of device is input to the NE1A-series Controller's safety input terminal.

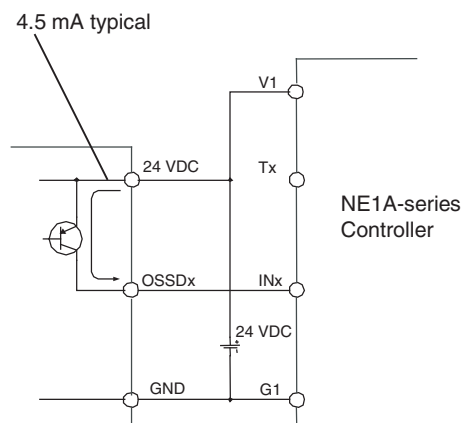

⚠ WARNING

Serious injury may possibly occur due to loss of required safety functions. Use appropriate components or devices according to the requirements given in the following table.

Controlling devices	Requirements
Emergency stop switch	Use approved devices with a direct opening mechanism compliant with IEC/EN 60947-5-1.
Door interlocking switch or limit switch	Use approved devices with a direct opening mechanism compliant with IEC/EN 60947-5-1 and capable of switching micro-loads of 4 mA at 24 VDC.
Safety sensor	Use approved devices compliant with the relevant product standards, regulations, and rules in the country where they are used.
Relay with forcibly guided contacts	Use approved devices with forcibly guided contacts compliant with EN 50205. For feedback, use devices with contacts capable of switching micro-loads of 4 mA at 24 VDC.
Contactors	Use contactors with a forcibly guided mechanism and monitor the auxiliary NC contact to detect contactor failures. For feedback, use devices with contacts capable of switching micro-loads of 4 mA at 24 VDC.
Other devices	Evaluate whether devices used are appropriate to satisfy the requirements of the safety category level.





IMPORTANT

- Properly apply the specified voltage to the NE1A-series Controller’s inputs. Applying an inappropriate DC voltage or any AC voltage may cause reduced safety functions, damage to the NE1A-series Controller, or a fire.
- Be sure to separate I/O cables from high-voltage/current lines.
- Use a total I/O communications cable length of 30 m or less.
- Do not apply the power supply to the test output terminals. Doing so may result in product damage or burning.

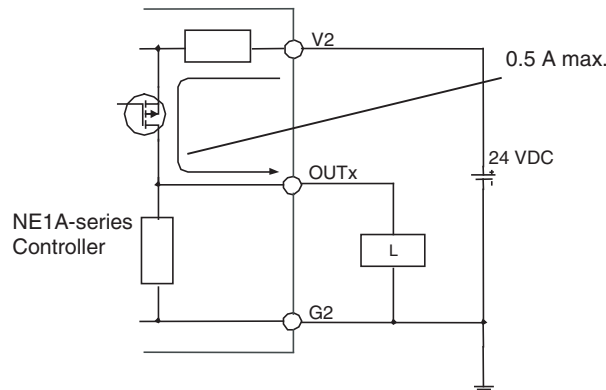
Wiring Output Devices

Refer to the following diagram for selection and wiring of output devices.



 WARNING	
<p>Serious injury may possibly occur due to breakdown of outputs. Do not connect loads beyond the rated value to the safety outputs and the test outputs.</p>	
<p>Serious injury may possibly occur due to loss of required safety functions. Wire the NE1A-series Controller properly so that 24-VDC lines do NOT touch the safety outputs and the test outputs accidentally or unintentionally.</p>	
<p>Serious injury may possibly occur due to loss of required safety functions. Ground the 0-V line of the power supply for external output devices so that the devices do NOT turn ON when the safety output line or the test output line is grounded.</p>	
<p>Serious injury may possibly occur due to loss of required safety functions. Use appropriate components or devices according to the requirements given in the following table.</p>	

Controlling Devices	Requirements
<p>Contactors</p>	<p>Use contactors with a forcibly guided mechanism and monitor the auxiliary NC contact to detect contactor failures.</p> <p>For feedback, use devices with contacts capable of switching micro-loads of 4 mA at 24 VDC.</p>
<p>Other devices</p>	<p>Evaluate whether devices used are appropriate to satisfy the requirements of safety category level.</p>

IMPORTANT

- Be sure to separate I/O cables from high-voltage/current lines.
- Use I/O cables of 30 m or less.
- Do not apply the power supply to the test output terminals. Doing so may result in product damage or burning.

Examples of I/O Device Connections

Example of Connecting an Emergency Stop Button

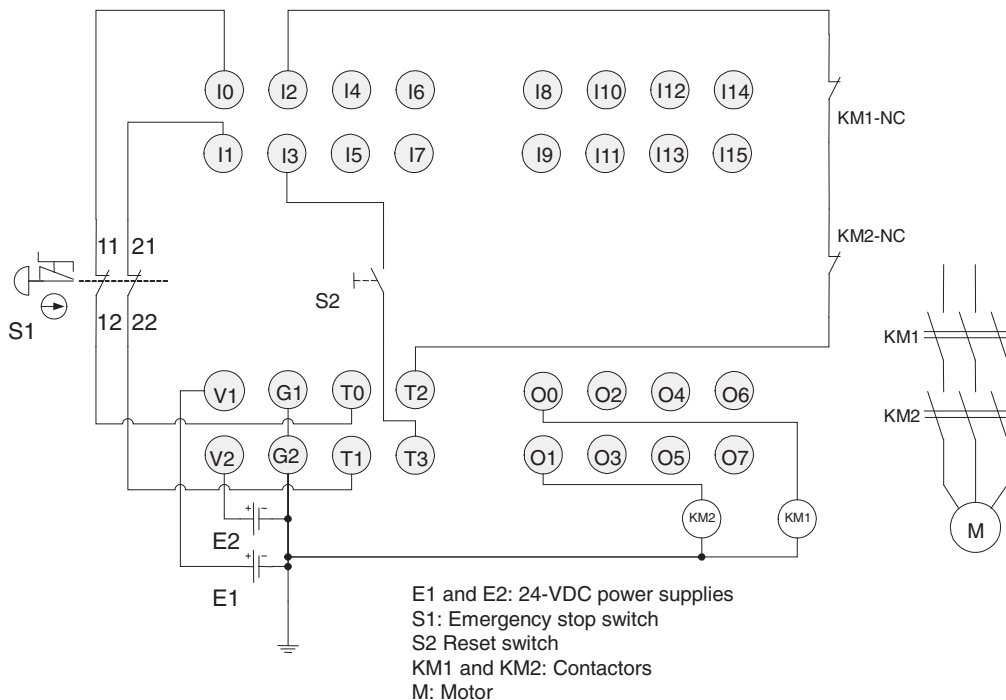

Note Connect a 24-VDC power supply to terminals V0 and G0 (power supply terminals for internal circuits).

Note This example shows the terminal layout for an NE1A-SCPU01(-V1) or NE1A-SCPU01-EIP Controller.

Example of Connecting Limit Switches (for a Safety Gate)

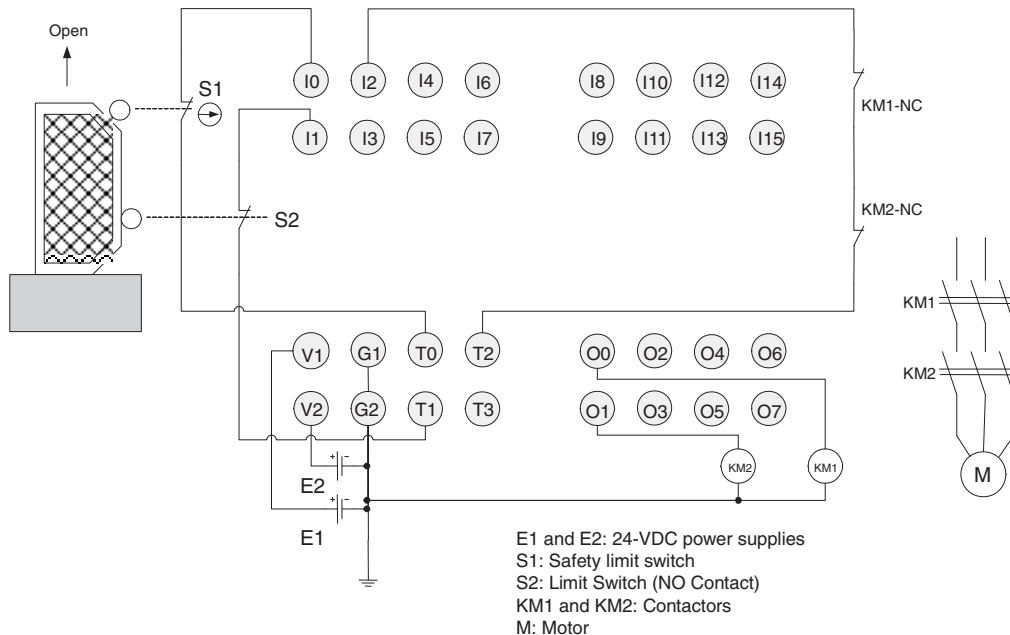

Note Connect a 24-VDC power supply to terminals V0 and G0 (power supply terminals for internal circuits).

Note This example shows the terminal layout for an NE1A-SCPU01(-V1) or NE1A-SCPU01-EIP Controller.

Example of Connecting Two-hand Control Switches

Observe the following precautions in applications of two-hand control switches.

- When connecting the switch, connect NO terminals to safety input terminals with even numbers (IN0 and IN2 in the following example) and connect NC terminals to safety input terminals with odd numbers (IN1 and IN3 in the following example).
- Set the safety Input terminals to single channels. (If you use the I/O Wizard, select a Two Hand Switch.)
- For dual-channel monitoring, use the Two-hand Control function block.

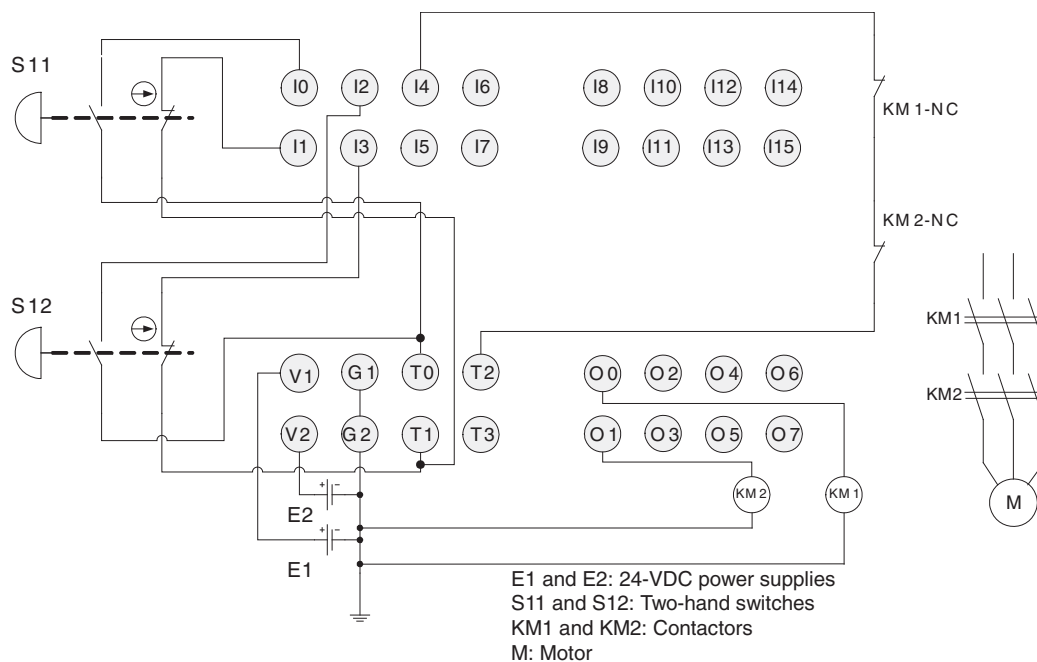

Note Connect a 24-VDC power supply to terminals V0 and G0 (power supply terminals for internal circuits).

Note This example shows the terminal layout for an NE1A-SCPU01(-V1) or NE1A-SCPU01-EIP Controller.

The input terminal settings for the above application are shown below. These are set either with the I/O Wizard or by editing the device parameters directly.

Setting Example

- Individual Settings for the Safety Input Terminals

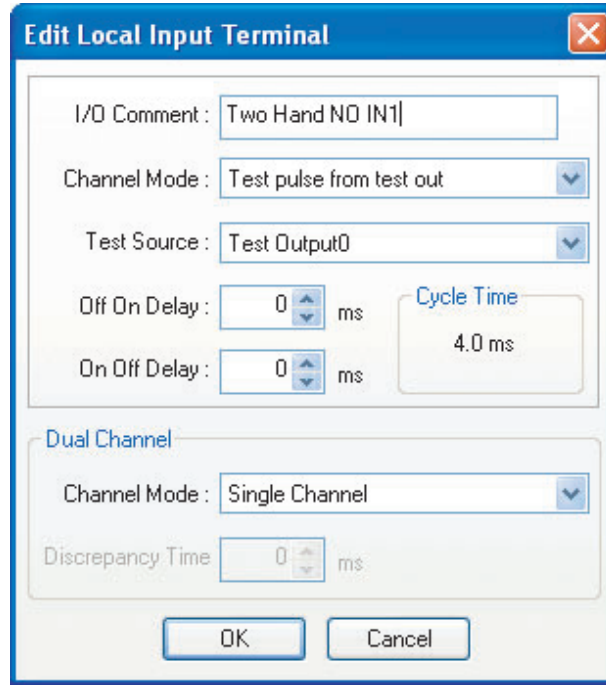

- Safety Input Terminal Settings

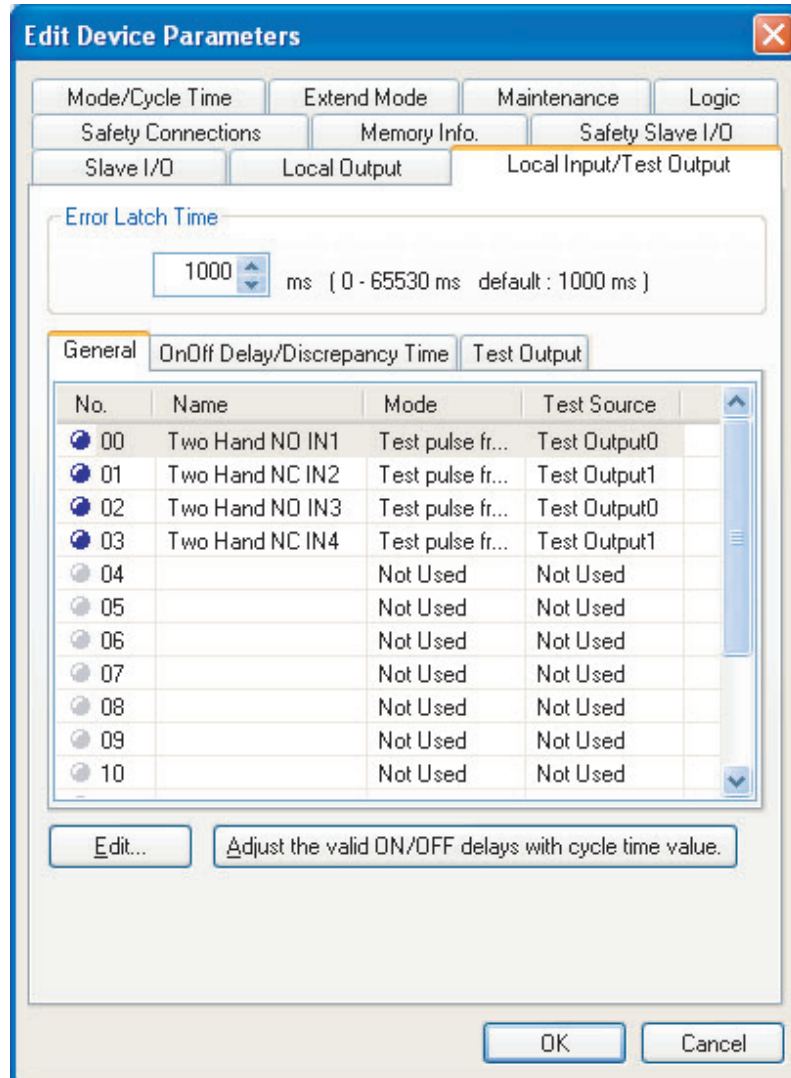

- Test Output Settings

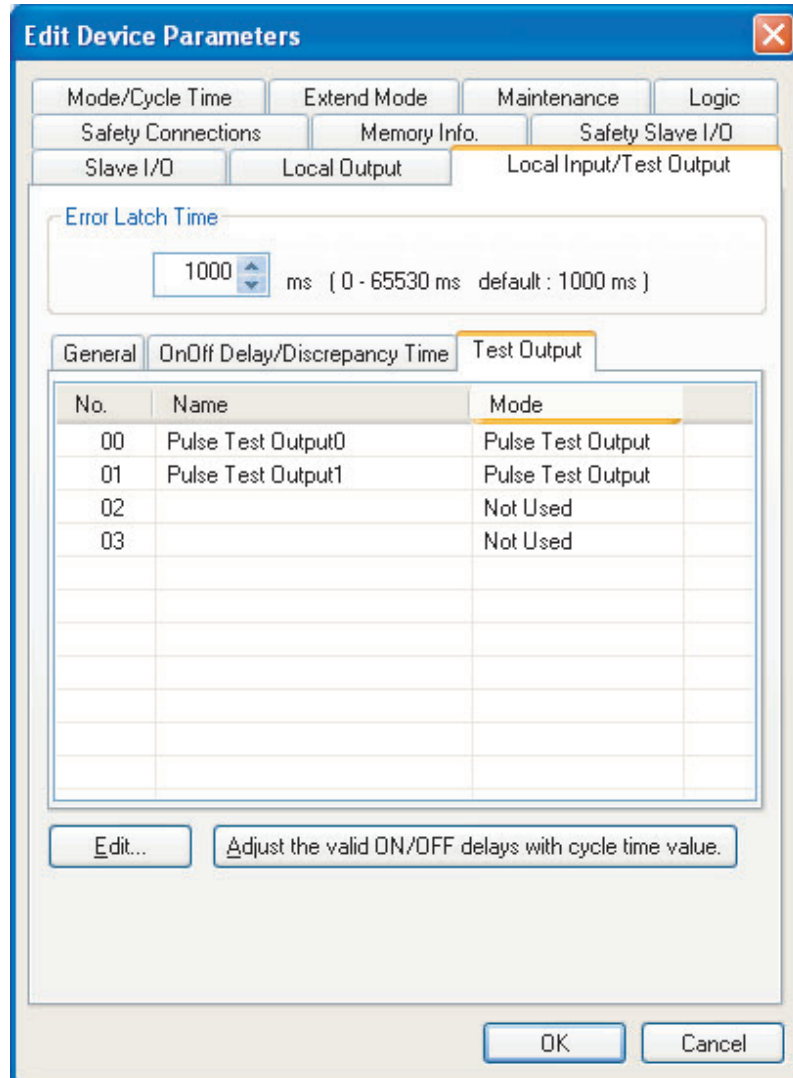

Example of Connecting a Light Curtain

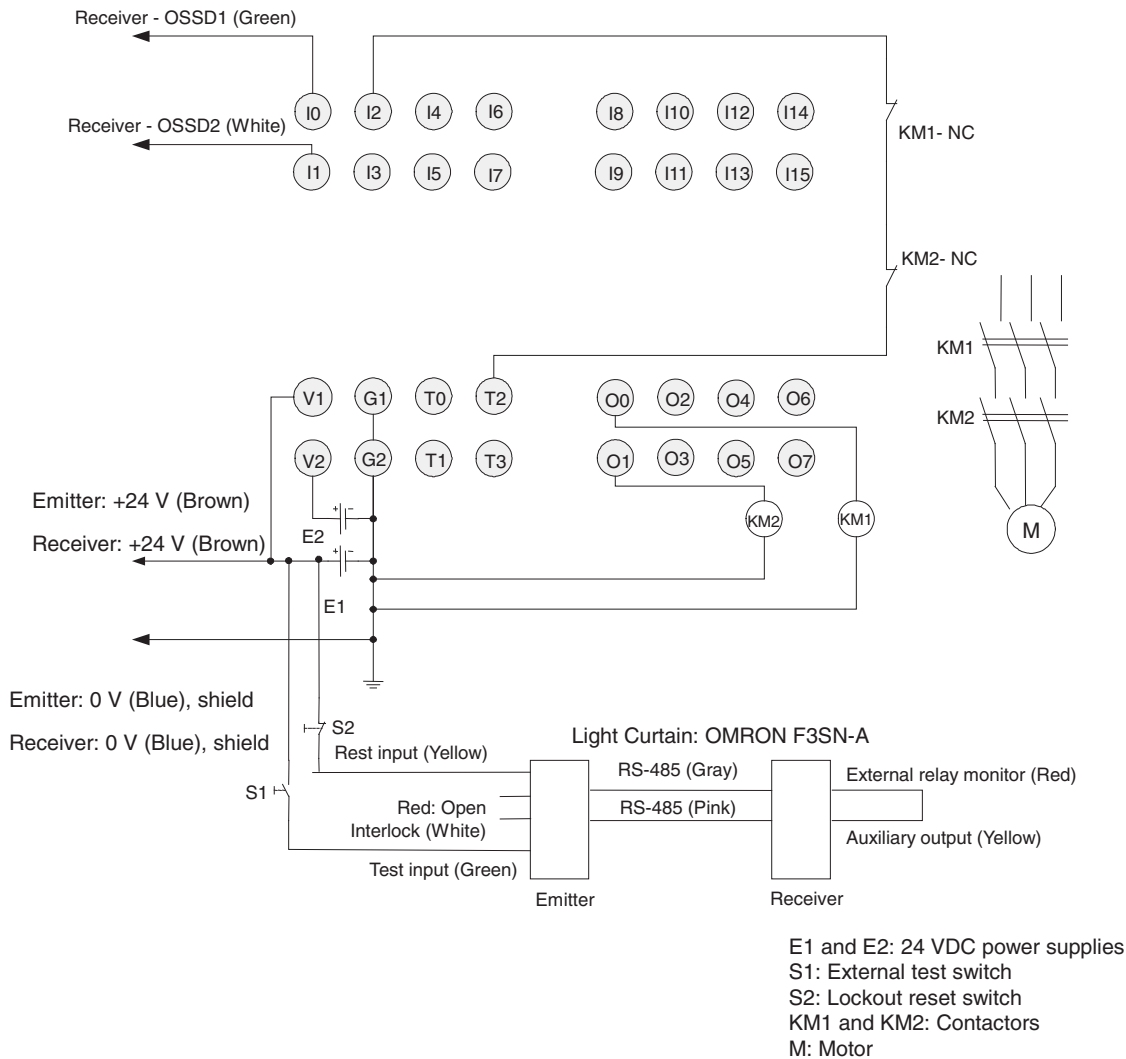

Note Connect a 24-VDC power supply to terminals V0 and G0 (power supply terminals for the internal circuits).

Note This example shows the terminal layout for an NE1A-SCPU01(-V1) or NE1A-SCPU01-EIP Controller.

Example of Connecting a User Mode Switch

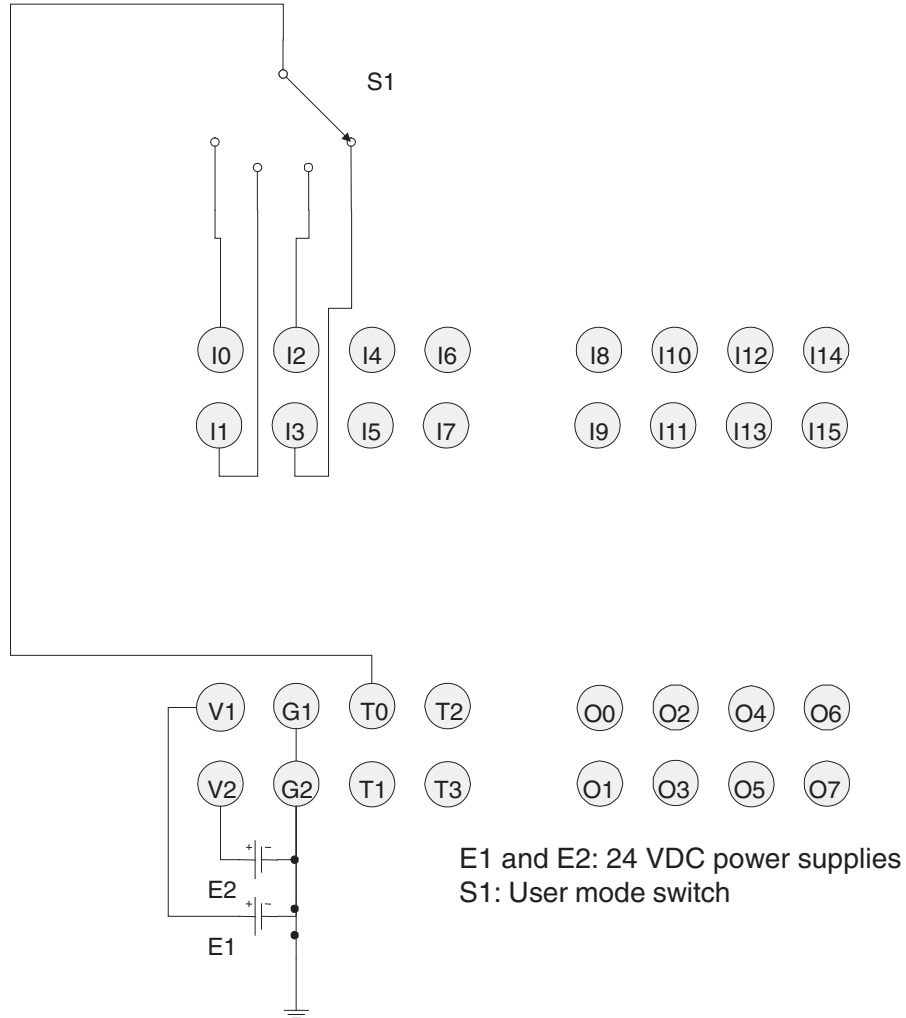

Note Connect a 24-VDC power supply to terminals V0 and G0 (power supply terminals for internal circuits).

Note This example shows the terminal layout for an NE1A-SCPU01(-V1) or NE1A-SCPU01-EIP Controller.

3-2-4 DeviceNet Wiring

Wire the DeviceNet communications cable as shown in the following diagram.

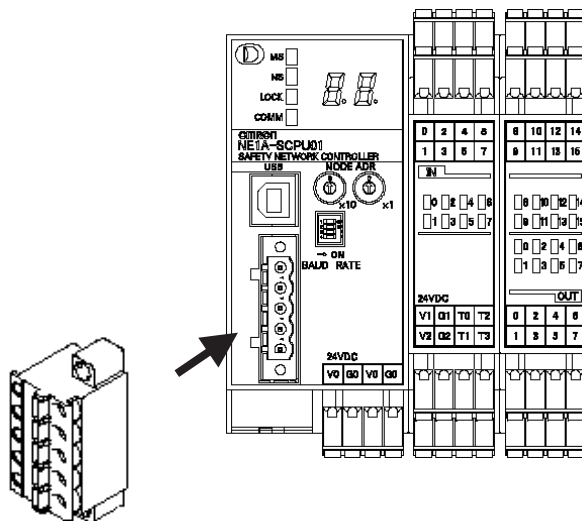

Stickers are placed on the communication connectors based on the color of each communications wire. By matching the communications wire colors with the connector sticker colors, you can check to see if wires are in the correct locations. The colors of the wires are as follows:

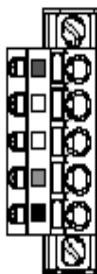

Color	Description
Red	V+
White	Signal (CAN H)
-	Drain
Blue	Signal (CAN L)
Black	V-

- IMPORTANT**
- Turn OFF the power supply to the NE1A-series Controller, to all nodes on the network, and to communications lines before starting any wiring operations.
 - Tighten the DeviceNet connector to the appropriate torque (0.25 to 0.3 N·m).
 - Separate the DeviceNet communications cables from high-voltage/current lines.
 - Use DeviceNet-compliant thin or thick cables for the communications cables. Do not use flat cables.

Note Refer to the *DeviceNet Operation Manual (W267)* for further information on wiring.

3-2-5 Wiring the USB Connector

A computer is connected to use the Network Configurator. Use a commercially available USB-A to USB-B Male/Male cable to make the connection.

IMPORTANT Use a USB cable of 3 meters max.

3-2-6 Ethernet (EtherNet/IP) Network Installation

Basic Installation Precautions

- Take the greatest care when installing the Ethernet System, being sure to follow ISO 8802-3 specifications. You must obtain a copy of these specifications and be sure you understand them before attempting to install an Ethernet System.
- Unless you are already experienced in installing communications systems, we strongly recommend that you employ a professional to install your system.
- Do not install Ethernet equipment near sources of noise. If a noisy environment is unavoidable, take adequate measures against noise interference, such as installing network components in grounded metal cases or using optical cable in the system.

Recommended Network Devices

The following table shows the devices recommended for use with the NE1A-series Controller.

Part	Maker	Model number	Inquires
Switching Hub	OMRON	W4S1-03B W4S1-05B W4S1-05C	OMRON Corporation
	Cisco Systems, Inc.	Consult the manufacturer.	Cisco Systems, Inc. Main Corporate HQ
	Contec USA, Inc.	Consult the manufacturer.	CONTEC USA Inc.
	Phoenix Contact	Consult the manufacturer.	Phoenix Contact USA Customer Service
Twisted-pair cable	100BASE-TX		
	Fujikura	F-LINK-E 0.5mm × 4P	Fujikura America, Inc.
	EtherNet/IP compliant cable		---
Connectors (Modular plug)	STP Plug		
	Panduit Corporation	MPS588	Panduit Corporation US Headquarters
Boots	Tsuko Company	MK boot (IV) LV	Tsuko Company Japan Headquarters

Note

- Ask the switching hub manufacturer for setting procedures for the switching hub.
- Install the switching hub so that its environmental resistance capabilities are not exceeded.
Ask the switching hub manufacturer for information on the environmental resistance of the switch hub.

Precautions

Precautions on Laying Twisted-pair Cable

- Noise resistance may be reduced by ground loops, which can occur due to improper shield connections and grounding. Ground the shield at one location, as shown in the following diagram.
- Do not connect a shield at the NE1A-series Controller connector.
- If a cable connects two hubs, connect the shields at only one end.

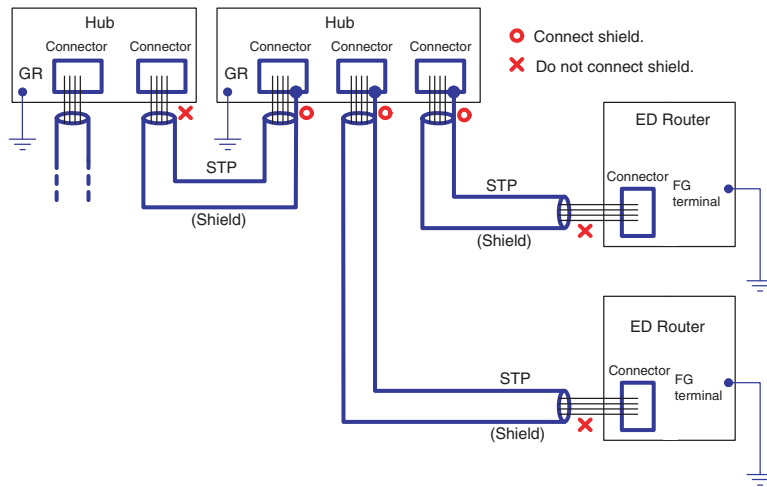

- Press the cable connector in firmly until it locks into place at both the switching hub and the NE1A-series Controller.
- Do not lay the twisted-pair cable together with high-voltage lines.
- Do not lay the twisted-pair cable near devices that generate noise.
- Do not lay the twisted-pair cable in locations subject to high temperatures or high humidity.
- Do not lay the twisted-pair cable in locations subject to excessive dirt and dust or to oil mist or other contaminants.
- Do not ground the switching hub in the same location as a drive-system component such as an inverter.
- Always use a dedicated power supply for the switching hub's power supply. Do not use the same power supply used for other equipment, such as an I/O power supply, motor power supply, or control power supply.
- Before installation, check the switching hub's environment-resistance specifications, and use a switching hub appropriate for the ambient conditions. Contact the switching hub manufacturer for details on switching hub's environment-resistance specifications.
- Connect two hubs to each other as follows: Connect an MDI port to an MDI-X port with a straight cable; connect two MDI ports with a cross cable; and connect two MDI-X ports with a cross cable.

Note It is very difficult to distinguish cross cables and straight cables by appearance. Incorrect cables will cause communications to fail. We recommend using cascade connections with straight cables whenever possible.

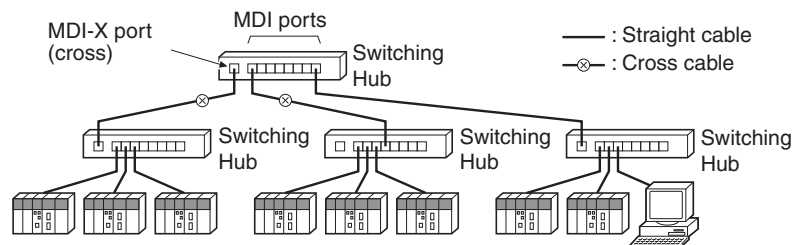

- Some switching hubs can automatically distinguish between MDI and MDI-X. When this kind of switching hub is being used, straight cable can be used between switching hubs.

Switching Hub Installation Environment Precautions

Switching Hub Connection Methods

Note NE1A-series Controller link settings must match the communications mode settings of connected switching hubs. If they do not match, links will be unstable and normal communications will not be possible. For EtherNet/IP I/O communications (tag data link communications) with an EtherNet/IP standard originator, it is recommended that auto-negotiation or 100M full-duplex communications be set for the Controller and the switching hubs.

NE1A-series Controller Switching hub		Auto-negotiation	10 Mbps		100 Mbps	
			Full	Half	Full	Half
Auto-negotiation		Recommended	Not connectible	Connectible	Not connectible	Connectible
10 Mbps	Full	Not connectible	Connectible	Not connectible	Not connectible	Not connectible
	Half	Connectible	Not connectible	Connectible	Not connectible	Not connectible
100 Mbps	Full	Not connectible	Not connectible	Not connectible	Recommended	Not connectible
	Half	Connectible	Not connectible	Not connectible	Not connectible	Connectible

Ethernet Connectors

The following standards and specifications apply to the connectors for the Ethernet twisted-pair cable.

- Electrical specifications: Conforming to IEEE802.3 standards.
- Connector structure: RJ45 8-pin Modular Connector (conforming to ISO 8877)

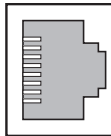

Connector pin	Signal name	Abbr.	Signal direction
1	Transmission data +	TD+	Output
2	Transmission data –	TD–	Output
3	Reception data +	RD+	Input
4	Not used.	---	---
5	Not used.	---	---
6	Reception data –	RD–	Input
7	Not used.	---	---
8	Not used.	---	---
Hood	Frame ground	FG	---

Connecting the Cable

Caution Turn OFF the power to the NE1A-series Controller before connecting or disconnecting twisted-pair cable.

Caution Allow enough space for the bending radius of the twisted-pair cable as shown in below.

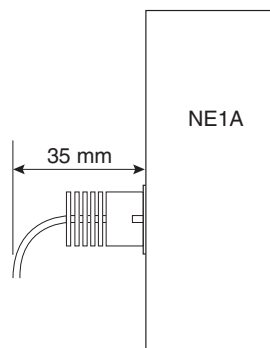

- 1,2,3...**
1. Lay the twisted-pair cable.
 2. Connect the cable to the switching hub. Be sure to press in the cable until it locks into place. This procedure should only be performed by qualified personnel.
 3. Connect the twisted-pair cable to the connector on the NE1A-series Controller.
Be sure to press the connectors (both the switching hub side and Ethernet side) until they lock into place.

SECTION 4

DeviceNet Communications Functions

4-1	Initial Setting	70
4-1-1	Hardware Setup	70
4-1-2	Software Settings	72
4-2	Network Status Indication	73
4-3	Remote I/O Allocations	74
4-3-1	Remote I/O Area Allocation Overview	74
4-3-2	Remote I/O Area Attributes	75
4-3-3	Remote I/O Area Data Configuration	76
4-4	Safety Master Function	88
4-4-1	Safety I/O Communications as Safety Master	88
4-4-2	Safety I/O Connection Settings	89
4-4-3	Stopping/Resetting Communications after an Error Unit Ver. 1.0 or Later	91
4-5	Safety Slave Function	94
4-5-1	Safety I/O Communications as Safety Slave	94
4-5-2	Creating I/O Data (Safety Slave I/O) to Use as Safety Slave	95
4-6	Standard Slave Function	98
4-6-1	Standard I/O Communications as Standard Slave	98
4-6-2	Creating I/O Data (Slave I/O) to Use as Standard Slave	98

4-1 Initial Setting

4-1-1 Hardware Setup

Node Address Setting

Set the DeviceNet node address using the rotary switches on the front of the NE1A-series Controller.



Method	Two-digit decimal number
Range	0 to 63

Note The node address is set to 63 at the factory.

Any node address in the setting range can be used as long as the same address is not used by another node. If a value between 64 and 99 is set on the rotary switches, the node address can be set using a software setting on the Network Configurator.

Software Setting

Use the following procedure to set the node address using the Network Configurator.

1. Turn OFF the power and then set the rotary switches to a number between 64 and 99 (software setting).
2. Turn ON the power. The NE1A-series Controller will operate using the previous node address (factory set to 63).
3. Reset to the default settings using the Network Configurator's RESET command.
The configuration information held in the device will be initialized.
4. Set the node address from the Network Configurator.

From here on, the NE1A-series Controller will operate with the node address set in the software setting.

IMPORTANT

- Turn OFF power to the NE1A-series Controller before setting the node addresses.
- Do not change the rotary switches while the power is ON. The NE1A-series Controller will detect this as a change in the configuration and will switch to Abort State.
- Use a small flat-blade screwdriver to set the rotary switches, being careful not to scratch them.

Note A node address duplication error will occur if the same address is set for more than one node. Communications will not start if this error occurs.

Baud Rate Setting

The DeviceNet baud rate is set using the DIP switch on the front of the NE1A-series Controller. The baud rates settings are shown in the following table:



Pin				Baud rate
1	2	3	4	
OFF	OFF	OFF	OFF	125 kbit/s
ON	OFF	OFF	OFF	250 kbit/s
OFF	ON	OFF	OFF	500 kbit/s
ON	ON	OFF	OFF	Software setting
ON or OFF	ON or OFF	ON	OFF	
ON or OFF	ON or OFF	ON or OFF	ON	Automatic baud rate detection

Note The baud rate is set to 125 kbit/s at the factory.

Software Setting

The Network Configurator can be used to set the baud rate. The procedure is as follows:

1. Turn OFF the power and change the DIP switch to the “software setting.”
2. Turn ON the power. When power is turned ON, the NE1A-series Controller will operate at the previous baud rate (default setting: 125 kbit/s).
3. Reset to the default settings using the Network Configurator’s RESET command.
The configuration information held in the device will be initialized.
4. Set the baud rate from the Network Configurator.
5. Reset the NE1A-series Controller by cycling the power or using the NE1A-series Controller RESET command from the Network Configurator. The NE1A-series Controller will then operate with the baud rate set from the Network Configurator, i.e., the software setting.

Automatic Baud Rate Detection

The NE1A-series Controller’s baud rate can be set automatically to match the baud rate of the master on the network. The baud rate must be set in at least one Safety Master or Standard Master on the network. After turning ON the power, the baud rate is set when establishing communications, and the baud rate setting is stored until the next time power is turned ON.

IMPORTANT

- Turn OFF power to the NE1A-series Controller before setting the DIP switch.
- Do not change the DIP switch setting while the power supply is ON. The NE1A-series Controller will detect this as a change in the configuration and will switch to ABORT State.
- The baud rate must be the same for all nodes (masters and slaves) on the network.

4-1-2 Software Settings

Disabling DeviceNet Communications (Standalone)

When DeviceNet Communications are disabled, the NE1A-series Controller stops all DeviceNet communications and operates as a Standalone Controller. The default is to have DeviceNet communications enabled (normal mode).

Make the setting from the Network Configurator. After the setting has been made, a reset command will be sent from the Network Configurator to the NE1A-series Controller to enable the setting.

Setting	Description
Enabled (Normal Mode)	DeviceNet communications enabled.
Disabled (Standalone Mode)	DeviceNet communications disabled. The NE1A-series Controller will operate as a Standalone Controller. "nd" will be displayed on the 7-segment display.

IMPORTANT

- When DeviceNet communications are disabled, connect the NE1A-series Controller to the Network Configurator via a USB connection or via EtherNet/IP (for Controllers that support EtherNet/IP).
- When DeviceNet communications are disabled, operation using the Network Configurator can be performed via a USB connection or via EtherNet/IP (for Controllers that support EtherNet/IP).

4-2 Network Status Indication

Network status is displayed on the NS/NS D indicator on the NE1A-series Controller. Refer to *2-1-2 Indicator/Display Areas* for details.

Note Error contents are shown through combinations of the MS and NS indicators, and seven-segment display. For the meanings of displays, refer to *SECTION 12 Troubleshooting*.

4-3 Remote I/O Allocations

4-3-1 Remote I/O Area Allocation Overview

The remote I/O areas used in Safety Masters/Slaves and Standard Masters/Slaves are automatically allocated in the NE1A-series Controller's I/O memory according to settings made from the Network Configurator. I/O of the destination communications slave and the I/O area for an NE1A-series slave are displayed as I/O tags. Using I/O tags allows a user to program without being conscious of the NE1A-series Controller's memory addresses.

I/O of the registered slave is displayed as I/O tags.

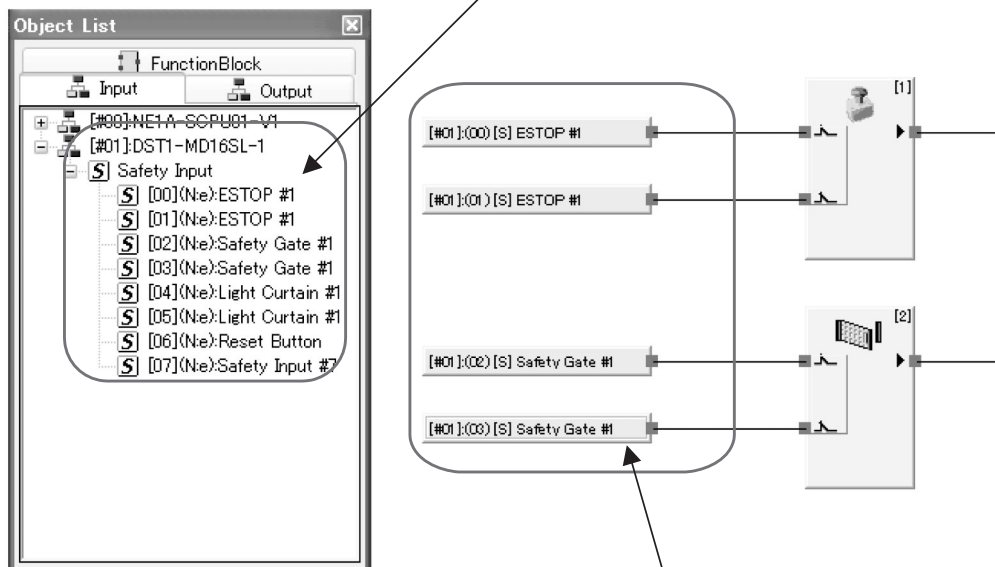

Programming with I/O tags

4-3-2 Remote I/O Area Attributes

Remote I/O Area Attributes

The NE1A-series Controller's remote I/O area has the following attributes.

All values in the safety remote I/O area will be cleared if the operating mode is changed. If a communications error occurs, all data for the connection for which the error occurred will be cleared.

	Mode change		Communications error	Power ON
	RUN to Idle	RUN or Idle to Configuration		
Safety remote I/O area (DeviceNet Safety)	Cleared (safety state)	Cleared (safety state)	Cleared for connection (safety state)	Cleared (safety state)
Standard remote I/O area (DeviceNet)	Depends on Slave I/O area hold setting.	Cleared	Depends on Slave I/O area hold setting.	Cleared

Note Refer to *SECTION 10 Operating Modes and Power Supply Interruptions* for details on each operating mode.

Slave I/O Area Hold Setting

Setting	Description	Default	Validity
Clear	The slave output area (inputs to a user application program) is cleared when a communications (connection) error occurs. The slave input area (outputs to a Standard Master) is cleared when the operating mode is changed to IDLE Mode.	Clear	When power supply is cycled
Hold	The last data in the slave output area (inputs to a user application program) is held when a communications (connection) error occurs. The last data in the slave input area (outputs to a Standard Master) is held when the operating mode is changed to IDLE Mode. Values are cleared, however, when a critical error or abort occurs or when the power supply is turned ON again.		

4-3-3 Remote I/O Area Data Configuration

The Network Configurator can be used to specify the data transferred by the NE1A-series Controller as Safety Slave or Standard Slave input data. This section describes the data that can be set, the setting method, and the data configuration.

Configuration of Data To Be Transferred

The Pre-Ver. 1.0 NE1A-series Controllers can combine status data and I/O data and transfer them as remote I/O data.

NE1A-series Controllers with unit version 1.0 or later (including Controllers that support EtherNet/IP) can combine status data, local I/O monitor data, and I/O data and transfer them as remote I/O data.

The data that is transferred is determined by the configuration. The data is normally configured of status data, local I/O monitor data, and I/O data, in that order. The status data can be collected in the PLC to create a monitoring system. The data can also be configured of only status data, only local I/O monitor data, or only I/O data.

Sample 1: Transmitting both Status Data and I/O Tags as Safety Slave Inputs

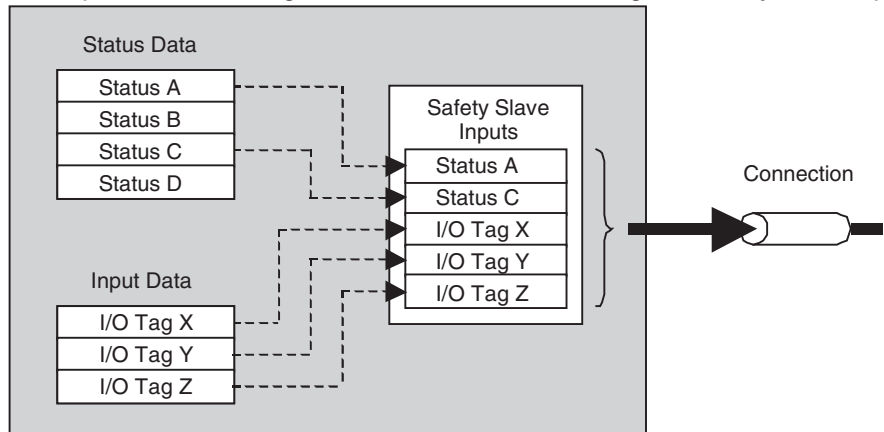

Sample 2: Transmitting Only I/O Tags as Safety Slave Inputs

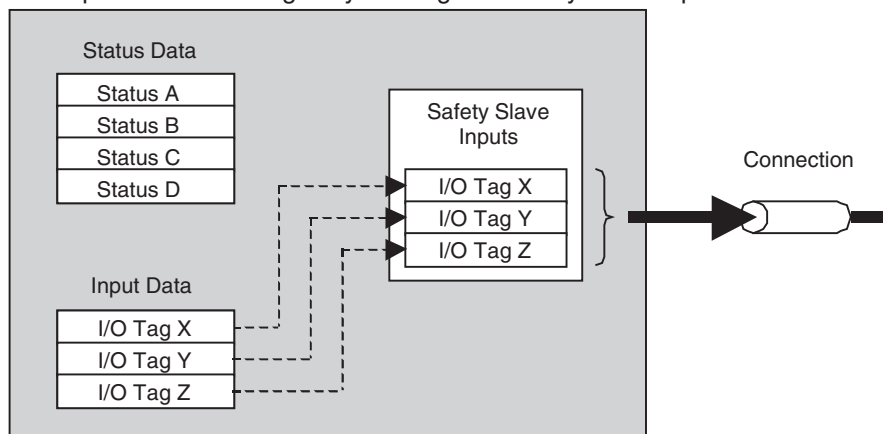

Sample 3: Transmitting Only Status Data as Standard Slave Inputs

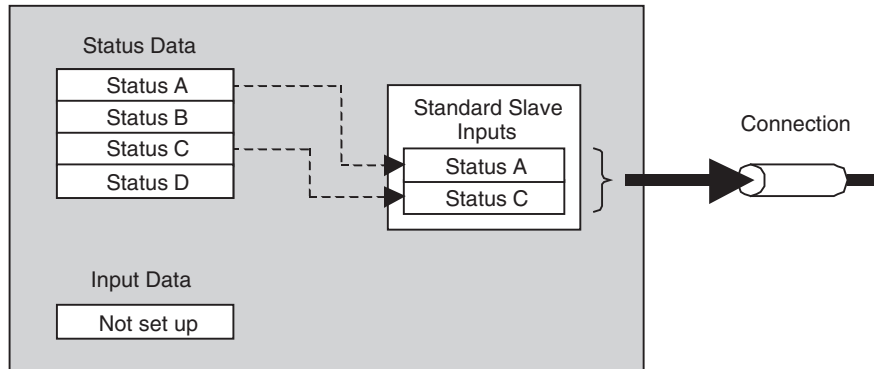

Data That Can Be Set and Example Arrangements

The following table shows the data that can be set.

- Pre-Ver. 1.0 NE1A-series Controllers

Data type	Name/format	Data size	Setting method using Network Configurator	Attribute
Status	General Status	Byte	Set using checkbox.	Non-safety
	Local Input Status	Word	Set using checkbox.	Safety
	Local Output Status	Byte	Set using checkbox.	Safety
	Test Output/Muting Lamp Status	Byte	Set using checkbox.	Non-safety
I/O tags	BOOL I/O Tags	Byte	User registered.	Safety
	BYTE I/O Tags	Byte	User registered.	Safety
	WORD I/O Tags	Word	User registered.	Safety
	DWORD (Double Word) I/O Tags	Double word	User registered.	Safety

- NE1A-series Controllers with Unit Version 1.0 or Later (Including Controllers that Support EtherNet/IP)

Data type	Name/format	Data size	Setting method using Network Configurator	Attribute
Status	General Status	Byte	Set using checkbox.	Non-safety
	Local I/O Status 1 to N (See note 1.)	Byte	Set using checkbox.	Safety
	Local Output Status	Byte	Set using checkbox.	Safety
	Test Output/Muting Lamp Status 1 to M (See note 1.)	Byte	Set using checkbox.	Non-safety
Local I/O monitor	Local Input Monitor 1 to N (See note 1.)	Byte	Set using checkbox.	Safety
	Local Output Monitor	Byte	Set using checkbox.	Non-safety
I/O tags	BOOL I/O Tags	Byte	User registered.	Safety
	BYTE I/O Tags	Byte	User registered.	Safety
	WORD I/O Tags	Word	User registered.	Safety
	DWORD (Double Word) I/O Tags	Double word	User registered.	Safety

Note For the NE1A-SCPU01(-V1)/NE1A-SCPU01-EIP, N = 2 and M = 1. For the NE1A-SCPU02/NE1A-SCPU02-EIP, N = 5 and M = 2. The sizes of the local input status, test output/muting lamp status, and local input monitor status data can be specified in bytes.

IMPORTANT The measures required for handling data as safety data in the data generation process will not be executed for status and I/O tag data items with a non-safety attribute. Therefore do not use those items to configure a safety system.

Moreover, even if the attribute for an item is “safety,” it will become “non-safety” for data input using standard I/O communications or for I/O tags connected with standard devices. Therefore, those items must also not be used to configure a safety system.

If the above data is combined, the I/O data will be configured as follows:

1. When status data is set, the status is allocated at the beginning of the remote I/O area in the order shown below. (Status areas that are not set are not reserved, i.e., no unassigned areas are left.)

General Status

↓

Local Input Status

↓

Local Output Status

↓

Test Output/Muting Lamp Status

2. When the local I/O monitor data is set (Controllers with unit version 1.0 or later only, including Controllers that support EtherNet/IP), the local I/O monitor data is attached after the other status data in the following order. (When local I/O monitor data is not set, the data will be shifted forward and that local I/O monitor area will not be reserved. This area does not exist in Pre-Ver. 1.0 Controllers.)

Local Input Monitor

↓

Local Output Monitor

3. After the status data and local I/O monitor data, user-registered I/O tags are allocated in the remote I/O area in the order of registration. At this time, free areas are not reserved and all valid data is allocated with no unassigned areas.

Examples of settings from the Network Configurator are shown below, along with the remote I/O area arrangements.

Settings from Network Configurator (Unit Version 1.0 or Later, Including Controllers that Support EtherNet/IP)



The following table shows the remote I/O area arrangement when the above settings are made.

Byte	Bit 7	Bit 6	Bit 5	Bit 4	Bit 3	Bit 2	Bit 1	Bit 0
0	General Status (1 byte)							
1	Local Input Status 1 (1 byte)							
2	Local Input Status 2 (1 byte)							
3	Local Output Status (1 byte)							
4	Test Output/Muting Lamp Status (1 byte)							
5	Byte A (1 byte)							
6	Word B (2 bytes)							
7								

Setting Example 2: Settings from Network Configurator (Unit Version 1.0 or Later, Including Controllers that Support EtherNet/IP)



The following table shows the remote I/O area arrangement when the above settings are made.

Byte	Bit 7	Bit 6	Bit 5	Bit 4	Bit 3	Bit 2	Bit 1	Bit 0
0	Local Input Status 1 (1 byte)							
1	Local Input Status 2 (1 byte)							
2	Local Output Status (1 byte)							
3	Bool C (1 byte)							
4	Dword D (4 bytes)							
5								
6								
7								

Setting Example 3: Settings from Network Configurator (Controllers with Unit Version 1.0 or Later, Including Controllers that Support EtherNet/IP)

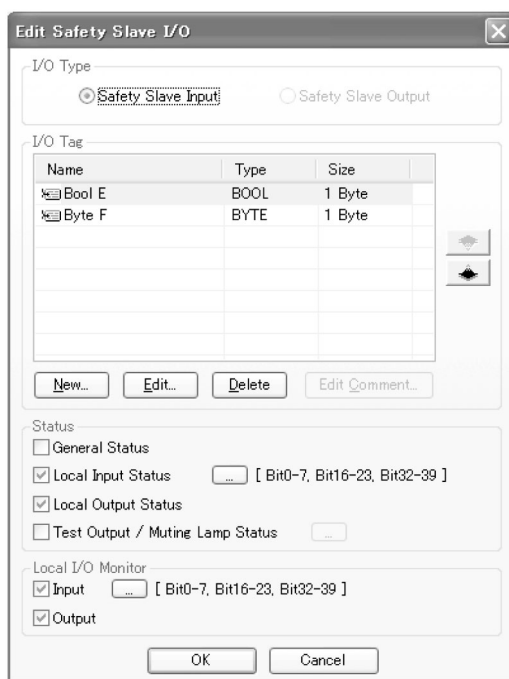

Byte	Bit 7	Bit 6	Bit 5	Bit 4	Bit 3	Bit 2	Bit 1	Bit 0
0	Local Input Status 1 (1 byte)							
1	Local Input Status 3 (1 byte)							
2	Local Input Status 5 (1 byte)							
3	Local Output Status (1 byte)							
4	Local Input Monitor 1 (1 byte)							
5	Local Input Monitor 3 (1 byte)							
6	Local Input Monitor 5 (1 byte)							
7	Local Output Monitor (1 byte)							
8	Bool E (1 byte)							
9	Byte F (1 byte)							

Bit Arrangements for Each Type of Data

The bit arrangements for status data and I/O tag settings are shown below.

Status Details

The following tables show the status details.

General Status (1 Byte)		Attribute: Non-safety Data
Bit	Content	Description
0	Input Power Supply Voltage Status OFF: Normal power supply is ON. ON: Power supply voltage error or power supply is OFF.	Indicates the status of the power supply voltage for inputs. This bit is OFF when local input power supply voltage (V1, G1) is being applied normally, or when local inputs are not being used.
1	Output Power Supply Voltage Status OFF: Normal power supply is ON. ON: Power supply voltage error or power supply is OFF.	Indicates the status of the power supply voltage for outputs. This bit is OFF when local output power supply voltage (V2, G2) is being applied normally, or when local outputs are not being used.
2	Standard I/O Communications Error Status OFF: No error ON: Error	Indicates if there is any error in standard I/O communications. “Error” indicates that an error has been detected in one or more connections. This bit is OFF when communications are not established or when normal communications are in progress. For Controllers that support EtherNet/IP, the status of this bit is an OR of the DeviceNet or EtherNet/IP standard communications status.
3	Standard I/O Communications Status OFF: I/O communications stopped or error ON: I/O communications in progress	Indicates whether standard I/O communications are in progress. This bit is ON if normal communications are in progress for all connections. Example: This bit is ON when two Slave I/O blocks are set and communications are established for only one of them and not the other. This bit is OFF, however, when communications are normal for one and a communications error occurs for the other. For Controllers that support EtherNet/IP, the status of this bit is an AND of the DeviceNet or EtherNet/IP standard communications status.
4	Safety I/O Communications Error Status OFF: No error ON: Error	Indicates if there is any error in Safety I/O communications. This bit is OFF when communications are not established (i.e., when d□ is not displayed at the 7-segment display) or while normal communications are in progress. ON when a communications error occurs at even one connection (i.e., when d5, d6, or dA is displayed at the 7-segment display).
5	Safety I/O Communications Status OFF: I/O communications stopped or error ON: I/O communications in progress	Indicates whether Safety I/O communications are in progress. When the NE1A-series Controller is Operating as a Safety Master Only This bit is OFF when a communications error occurs at even one connection (i.e., when d5, d6, or dA is displayed at the 7-segment display). This bit is ON when all Safety Master I/O communications are normal. When the NE1A-series Controller is Operating as a Safety Master and a Safety Slave This bit is ON when all Safety Master I/O communications are normal and there is no error in any Safety Slave communications (i.e., when dA is not displayed at the 7-segment display). OFF at all other times.

Bit	Content	Description
6	RUN Status OFF: Not RUN Mode ON: RUN Mode	Indicates the operating mode of the NE1A-series Controller.
7	Normal Status OFF: Error ON: Normal	Indicates the status of the NE1A-series Controller. This flag will indicate an error when any of the errors indicated in the error details (<i>12-4-2 Error Information Details</i>) occurs.

Example: Monitoring NE1A-series Controller Standard I/O Communications Error and Status Flags from the PLC

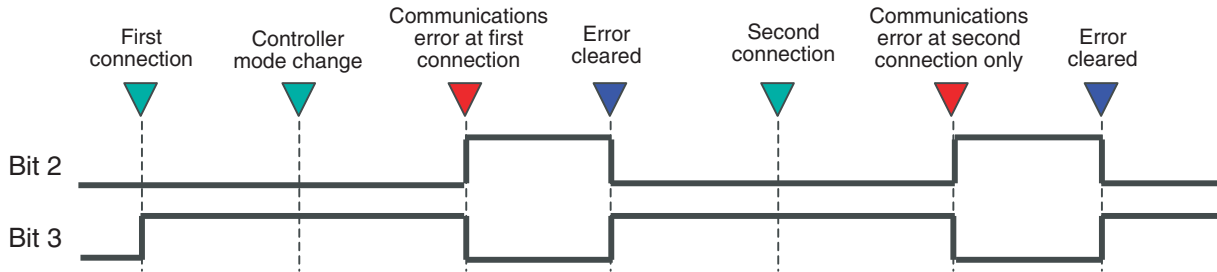

When the NE1A-series Controller is Operating as a Safety Master Only

- Example: Monitoring NE1A-series Controller Safety I/O Communications Error and Status Flags from the PLC (when a dA Error Occurs)

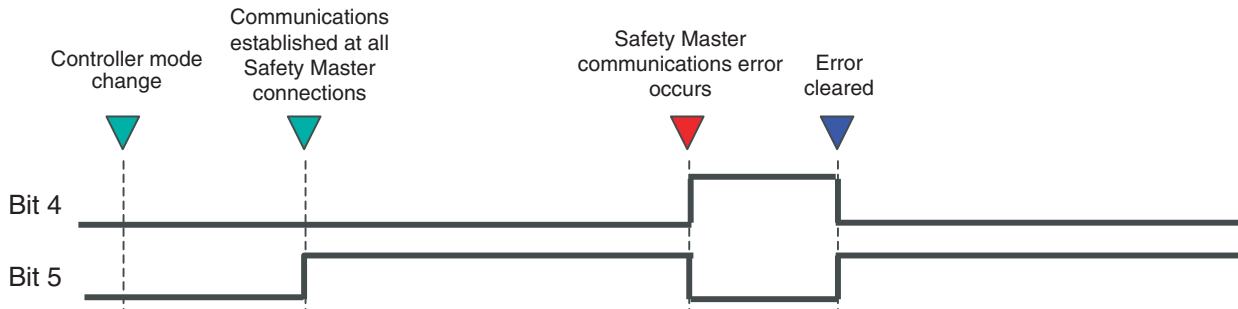

- Example: Monitoring NE1A-series Controller Safety I/O Communications Error and Status Flags from the PLC (when d5 and d6 Errors Occur)

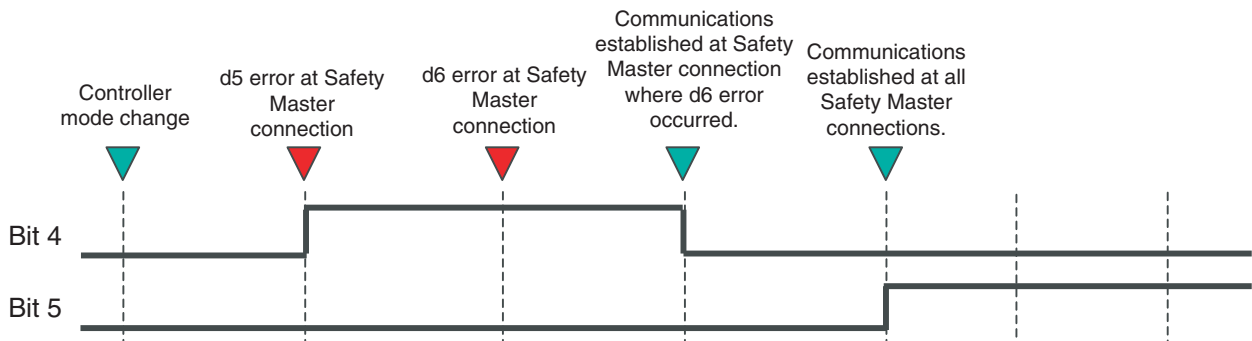

When the NE1A-series Controller is Operating as a Safety Master and a Safety Slave

- Example: Monitoring NE1A-series Controller Safety I/O Communications Error and Status Flags from the PLC (when a dA Error Occurs)

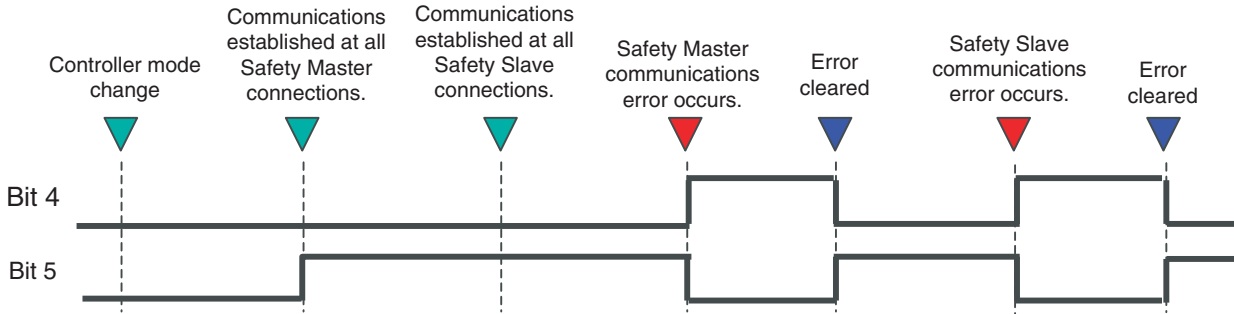

- Example: Monitoring NE1A-series Controller Safety I/O Communications Error and Status Flags from the PLC (when d5 and d6 Errors Occur)

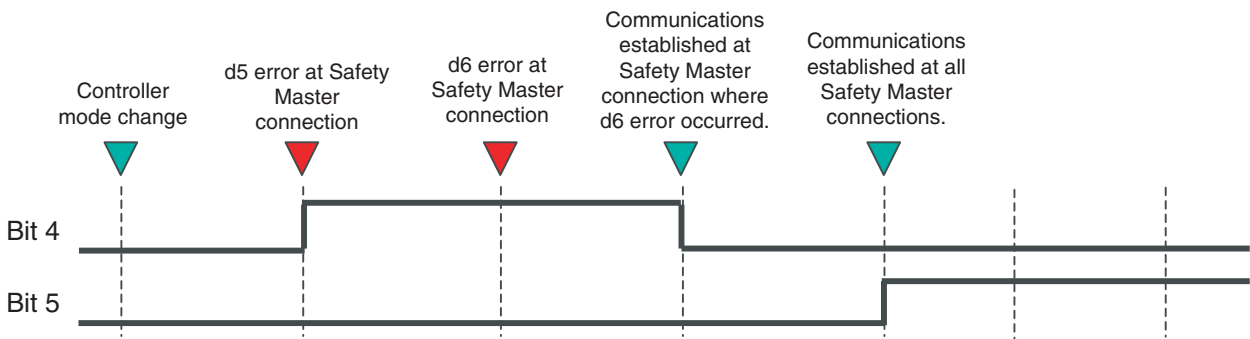

Example: Monitoring NE1A-series Run Status and Normal Status Flags from the PLC

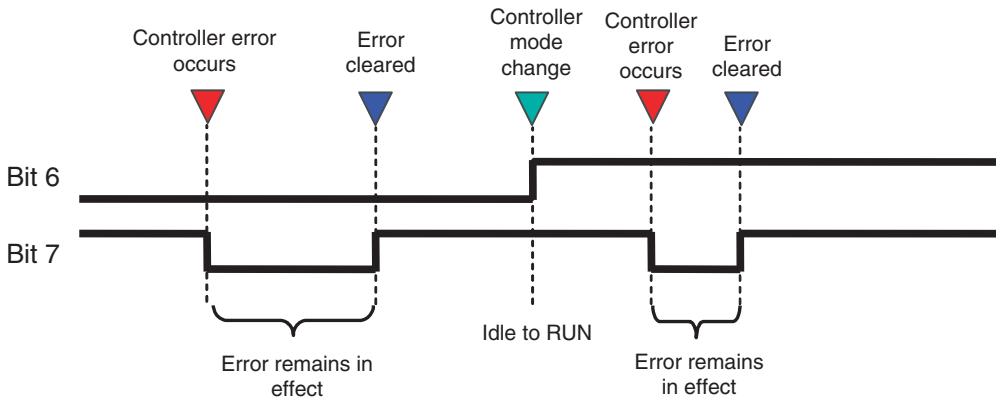

Note Be careful when monitoring general status from a Standard PLC, because all bits are regarded as OFF from the PLC ladder program before communications are established or while a communications error is in effect.

Example: Monitoring NE1A-series Run Status Flags from the PLC

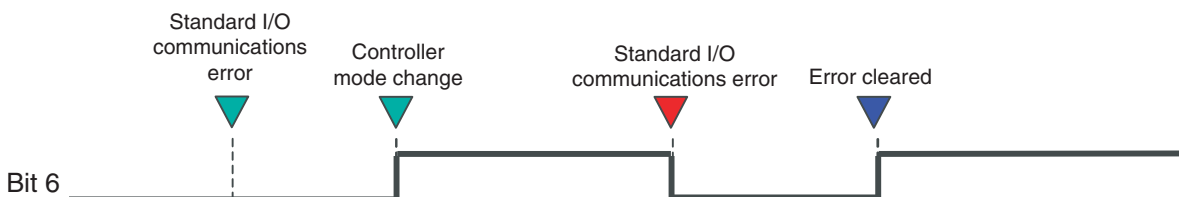

Local Input Status (2 Bytes, Pre-Ver. 1.0 Controllers)**Attribute: Safety Data**

Byte	Bit 7	Bit 6	Bit 5	Bit 4	Bit 3	Bit 2	Bit 1	Bit 0
0	Safety input terminal 7 status	Safety input terminal 6 status	Safety input terminal 5 status	Safety input terminal 4 status	Safety input terminal 3 status	Safety input terminal 2 status	Safety input terminal 1 status	Safety input terminal 0 status
1	Safety input terminal 15 status	Safety input terminal 14 status	Safety input terminal 13 status	Safety input terminal 12 status	Safety input terminal 11 status	Safety input terminal 10 status	Safety input terminal 9 status	Safety input terminal 8 status

ON: Normal, OFF: Error

Local Input Status 1 (1 Byte, Controllers with Unit Version 1.0 or Later, Including Controllers that Support EtherNet/IP)**Attribute: Safety Data**

Byte	Bit 7	Bit 6	Bit 5	Bit 4	Bit 3	Bit 2	Bit 1	Bit 0
0	Safety input terminal 7 status	Safety input terminal 6 status	Safety input terminal 5 status	Safety input terminal 4 status	Safety input terminal 3 status	Safety input terminal 2 status	Safety input terminal 1 status	Safety input terminal 0 status

ON: Normal, OFF: Error

Local Input Status 2 (1 Byte, Controllers with Unit Version 1.0 or Later, Including Controllers that Support EtherNet/IP)**Attribute: Safety Data**

Byte	Bit 7	Bit 6	Bit 5	Bit 4	Bit 3	Bit 2	Bit 1	Bit 0
0	Safety input terminal 15 status	Safety input terminal 14 status	Safety input terminal 13 status	Safety input terminal 12 status	Safety input terminal 11 status	Safety input terminal 10 status	Safety input terminal 9 status	Safety input terminal 8 status

ON: Normal, OFF: Error

Local Input Status 3 (1 Byte, NE1A-SCPU02 or NE1A-SCPU02-EIP)**Attribute: Safety Data**

Byte	Bit 7	Bit 6	Bit 5	Bit 4	Bit 3	Bit 2	Bit 1	Bit 0
0	Safety input terminal 23 status	Safety input terminal 22 status	Safety input terminal 21 status	Safety input terminal 20 status	Safety input terminal 19 status	Safety input terminal 18 status	Safety input terminal 17 status	Safety input terminal 16 status

ON: Normal, OFF: Error

Local Input Status 4 (1 Byte, NE1A-SCPU02 or NE1A-SCPU02-EIP)**Attribute: Safety Data**

Byte	Bit 7	Bit 6	Bit 5	Bit 4	Bit 3	Bit 2	Bit 1	Bit 0
0	Safety input terminal 31 status	Safety input terminal 30 status	Safety input terminal 29 status	Safety input terminal 28 status	Safety input terminal 27 status	Safety input terminal 26 status	Safety input terminal 25 status	Safety input terminal 24 status

ON: Normal, OFF: Error

Local Input Status 5 (1 Byte, NE1A-SCPU02 or NE1A-SCPU02-EIP)**Attribute: Safety Data**

Byte	Bit 7	Bit 6	Bit 5	Bit 4	Bit 3	Bit 2	Bit 1	Bit 0
0	Safety input terminal 39 status	Safety input terminal 38 status	Safety input terminal 37 status	Safety input terminal 36 status	Safety input terminal 35 status	Safety input terminal 34 status	Safety input terminal 33 status	Safety input terminal 32 status

ON: Normal, OFF: Error

Local Output Status (1 Byte)

Attribute: Safety Data

Byte	Bit 7	Bit 6	Bit 5	Bit 4	Bit 3	Bit 2	Bit 1	Bit 0
0	Safety output terminal 7 status	Safety output terminal 6 status	Safety output terminal 5 status	Safety output terminal 4 status	Safety output terminal 3 status	Safety output terminal 2 status	Safety output terminal 1 status	Safety output terminal 0 status

ON: Normal, OFF: Error

Test Output/Muting Lamp Status (1 Byte, Pre-Ver. 1.0 Controllers) Attribute: Non-safety

Byte	Bit 7	Bit 6	Bit 5	Bit 4	Bit 3	Bit 2	Bit 1	Bit 0
0	Test output terminal 3 disconnection detected status	Reserved			Test output terminal 3 status	Test terminal 2 status	Test output terminal 1 status	Test output terminal 0 status

ON: Normal, OFF: Error

Test Output/Muting Lamp Status 1 (1 Byte, Controllers with Unit Version 1.0 or Later, Including Controllers that Support EtherNet/IP) Attribute: Non-safety

Byte	Bit 7	Bit 6	Bit 5	Bit 4	Bit 3	Bit 2	Bit 1	Bit 0
0	Test output terminal 3 disconnection detected status	Reserved			Test output terminal 3 status	Test output terminal 2 status	Test output terminal 1 status	Test output terminal 0 status

ON: Normal, OFF: Error

Test Output/Muting Lamp Status 2 (1 Byte, NE1A-SCPU02 or NE1A-SCPU02-EIP) Attribute: Non-safety

Byte	Bit 7	Bit 6	Bit 5	Bit 4	Bit 3	Bit 2	Bit 1	Bit 0
0	Test output terminal 7 disconnection detected status	Reserved			Test output terminal 7 status	Test output terminal 6 status	Test output terminal 5 status	Test output terminal 4 status

ON: Normal, OFF: Error

Local Input Monitor 1 (1 Byte, Controllers with Unit Version 1.0 or Later, Including Controllers that Support EtherNet/IP) Attribute: Safety Data

Byte	Bit 7	Bit 6	Bit 5	Bit 4	Bit 3	Bit 2	Bit 1	Bit 0
0	Safety input terminal 7 monitor	Safety input terminal 6 monitor	Safety input terminal 5 monitor	Safety input terminal 4 monitor	Safety input terminal 3 monitor	Safety input terminal 2 monitor	Safety input terminal 1 monitor	Safety input terminal 0 monitor

ON: ON, OFF: OFF

Local Input Monitor 2 (1 Byte, Controllers with Unit Version 1.0 or Later, Including Controllers that Support EtherNet/IP)
Attribute: Safety Data

Byte	Bit 7	Bit 6	Bit 5	Bit 4	Bit 3	Bit 2	Bit 1	Bit 0
0	Safety input terminal 15 monitor	Safety input terminal 14 monitor	Safety input terminal 13 monitor	Safety input terminal 12 monitor	Safety input terminal 11 monitor	Safety input terminal 10 monitor	Safety input terminal 9 monitor	Safety input terminal 8 monitor

ON: ON, OFF: OFF

Local Input Monitor 3 (1 Byte, NE1A-SCPU02 or NE1A-SCPU02-EIP)

Attribute: Safety Data

Byte	Bit 7	Bit 6	Bit 5	Bit 4	Bit 3	Bit 2	Bit 1	Bit 0
0	Safety input terminal 23 monitor	Safety input terminal 22 monitor	Safety input terminal 21 monitor	Safety input terminal 20 monitor	Safety input terminal 19 monitor	Safety input terminal 18 monitor	Safety input terminal 17 monitor	Safety input terminal 16 monitor

ON: ON, OFF: OFF

Local Input Monitor 4 (1 Byte, NE1A-SCPU02 or NE1A-SCPU02-EIP)

Attribute: Safety Data

Byte	Bit 7	Bit 6	Bit 5	Bit 4	Bit 3	Bit 2	Bit 1	Bit 0
0	Safety input terminal 31 monitor	Safety input terminal 30 monitor	Safety input terminal 29 monitor	Safety input terminal 28 monitor	Safety input terminal 27 monitor	Safety input terminal 26 monitor	Safety input terminal 25 monitor	Safety input terminal 24 monitor

ON: ON, OFF: OFF

Local Input Monitor 5 (1 Byte, NE1A-SCPU02 or NE1A-SCPU02-EIP)

Attribute: Safety Data

Byte	Bit 7	Bit 6	Bit 5	Bit 4	Bit 3	Bit 2	Bit 1	Bit 0
0	Safety input terminal 39 monitor	Safety input terminal 38 monitor	Safety input terminal 37 monitor	Safety input terminal 36 monitor	Safety input terminal 35 monitor	Safety input terminal 34 monitor	Safety input terminal 33 monitor	Safety input terminal 32 monitor

ON: ON, OFF: OFF

Local Output Monitor (1 Byte)

Attribute: Non-safety

Byte	Bit 7	Bit 6	Bit 5	Bit 4	Bit 3	Bit 2	Bit 1	Bit 0
0	Safety output terminal 7 monitor	Safety output terminal 6 monitor	Safety output terminal 5 monitor	Safety output terminal 4 monitor	Safety output terminal 3 monitor	Safety output terminal 2 monitor	Safety output terminal 1 monitor	Safety output terminal 0 monitor

ON: ON, OFF: OFF

Note The results of appraising input data is given for the local input monitor status. The status may not be the same as the status of the connected input device if channel mode is set or an error occurs.

I/O Tag Details

The following tables show the I/O tag details.

BOOL

Byte	Bit 7	Bit 6	Bit 5	Bit 4	Bit 3	Bit 2	Bit 1	Bit 0
0	Open (=0)							User data Bit 0

BYTE

Byte	Bit 7	Bit 6	Bit 5	Bit 4	Bit 3	Bit 2	Bit 1	Bit 0
0	User data Bit 7	User data Bit 6	User data Bit 5	User data Bit 4	User data Bit 3	User data Bit 2	User data Bit 1	User data Bit 0

WORD

Byte	Bit 7	Bit 6	Bit 5	Bit 4	Bit 3	Bit 2	Bit 1	Bit 0
0	User data Bit 7	User data Bit 6	User data Bit 5	User data Bit 4	User data Bit 3	User data Bit 2	User data Bit 1	User data Bit 0
1	User data Bit 15	User data Bit 14	User data Bit 13	User data Bit 12	User data Bit 11	User data Bit 10	User data Bit 9	User data Bit 8

DWORD

Byte	Bit 7	Bit 6	Bit 5	Bit 4	Bit 3	Bit 2	Bit 1	Bit 0
0	User data Bit 7	User data Bit 6	User data Bit 5	User data Bit 4	User data Bit 3	User data Bit 2	User data Bit 1	User data Bit 0
1	User data Bit 15	User data Bit 14	User data Bit 13	User data Bit 12	User data Bit 11	User data Bit 10	User data Bit 9	User data Bit 8
2	User data Bit 23	User data Bit 22	User data Bit 21	User data Bit 20	User data Bit 19	User data Bit 18	User data Bit 17	User data Bit 16
3	User data Bit 31	User data Bit 30	User data Bit 29	User data Bit 28	User data Bit 27	User data Bit 26	User data Bit 25	User data Bit 24

Unused bits among the above user-registered I/O tags will be fixed at 0.

4-4 Safety Master Function

4-4-1 Safety I/O Communications as Safety Master

Safety I/O communications are used to exchange data automatically with Safety Slaves without user programming.

To perform safety I/O communications with other slaves, the following items are required:

1. Registration of slave devices in the NE1A-series Controller.
2. Safety I/O connection settings.

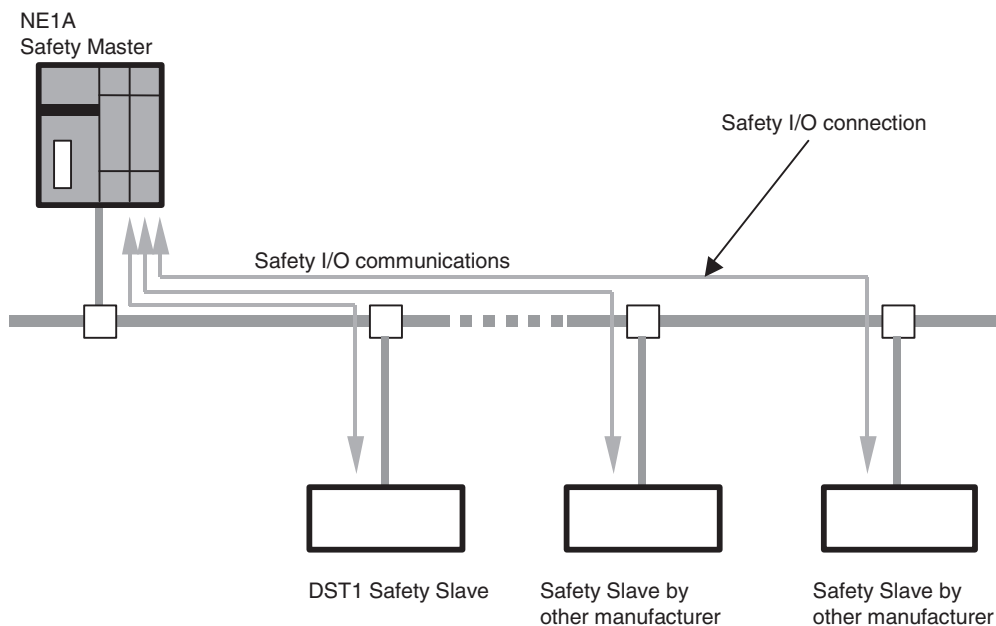

Safety Master Specifications

Safety I/O Connections	
Number of connections	Pre-Ver. 1.0 Controllers: 16 max. Controllers with unit version 1.0 or later, including Controllers that support EtherNet/IP: 32 max.
Maximum data size	16 bytes of input or 16 bytes of output (per connection)
Connection type	Single cast or multicast

Safety Slave Allocations

Safety Slaves that communicate with the NE1A-series Controller are allocated automatically in the Controller’s I/O memory based on the settings made from the Network Configurator. In the Logic Editor, slave I/O is displayed as I/O tags. Using these I/O tags allows a user to program without being aware of specific memory addresses in the NE1A-series Controller.

4-4-2 Safety I/O Connection Settings

Safety connections must be set in order to perform safety I/O communications between the NE1A-series Controller and the Safety Slaves. A “connection” is a logical communications path for a master and slave to communicate with each other.

Safety I/O connection settings include the following settings:

1. I/O connection settings (Selecting I/O data used in the slave.)
2. Open type setting
3. Connection type setting
4. EPI (data expected packet interval) setting

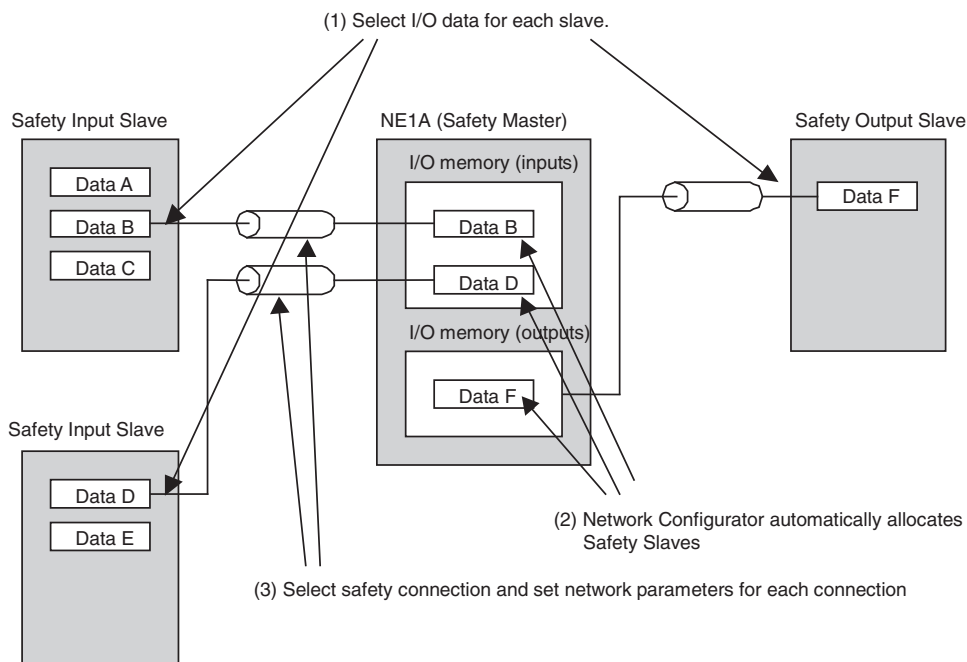

I/O Connection Settings

Some slaves have multiple I/O data (I/O assembly data) internally and the data to be communicated from them can be selected. Here, the data to allocated in the NE1A-series Controller can be specified from the data in the registered Safety Slave.

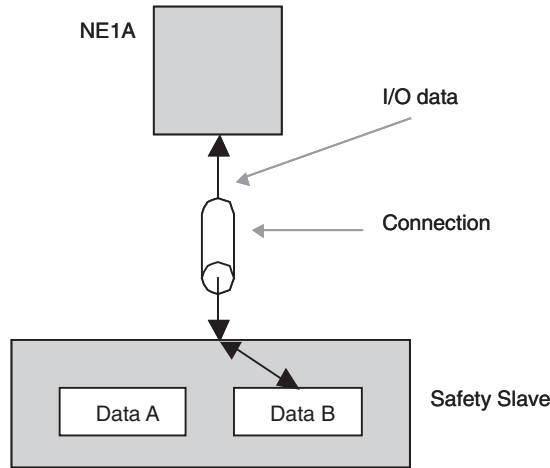

Open Type Setting

Select the open type that the NE1A-series Controller uses when establishing a connection.

Open type	Description
Configure the Safety Slave	Configures the Safety Slave when establishing the connection.
Check the Safety Signature	Checks that the configuration of the Safety Slave is correct by checking the safety signature when establishing the connection.
Open Only	Does not check that the configuration of Safety Slave is correct when establishing the connection.

⚠ WARNING

Serious injury may possibly occur due to loss of required safety functions. Serious injury may possibly occur due to loss of required safety functions. Always be sure that the Safety Master or Safety Slave has the correct configuration before setting the open type to *Open Only*.



Connection Type Setting

Select the safety connection type to use with Safety Slaves.
Either of the following two safety connections can be selected.

Connection type	Description
Multicast Connection	Multicast connections can be selected only for Safety Input Slaves. When a multicast connection is selected, the Safety Input Slave can transmit the input data to a maximum of 15 NE1A-series Safety Masters in multicast mode. NE1A-series Safety Masters that have the same I/O data type specified for I/O connections and the same EPI value are handled as the same multicast group. It is possible to select this connection even for just one NE1A-series Safety Master.
Single-cast Connection	With a single-cast connection, the Safety Master and Safety Slave perform 1:1 Safety I/O communications.

EPI (Data Expected Packet Interval) Setting

Set the interval to communicate safety data between the NE1A-series Safety Master and Safety Slaves. Devices that transmit data to network are monitored to confirm they can transmit the data within the set time interval and devices that receive data are monitored to confirm they can receive normal data within the data transmission interval using timers. If the data is not received, the connection is disconnected and a switch is made to the safety state.

Note

- The time set here affects the network reaction time.
Refer to *SECTION 11 Remote I/O Communications Performance and Local I/O Response Time* and to *Section 2 Constructing a Safety Network* in the *DeviceNet Safety System Configuration Manual* (Cat. No. Z905) for information on the network reaction time.
- The minimum set for the EPI is either the cycle time of the Safety Network Controller or the cycle time of the Safety Slaves (always 6 ms), whichever is greater. The minimum setting for the EPI will therefore be affected if the cycle time of the Safety Network Controller is longer than 6 ms.

4-4-3 Stopping/Resetting Communications after an Error**Unit Ver. 1.0 or Later**

With Controllers with unit version 1.0 or later (including Controllers that support EtherNet/IP), the user can specify whether to stop or continue I/O communications after the connection times out during safety I/O communications with the safety slave. If I/O communications are stopped because of a timeout error, the communications can be restarted from the user program or a Network Configurator.

With Pre-Ver. 1.0 Controllers, I/O communications are continued (automatic recovery).

Setting the Operating Mode after a Communications Error

One of the following modes can be selected to specify the Controller's operation when there is a connection timeout during safety I/O communications with the safety slave.

Mode after communications error	Description
Automatic recovery	Specify this mode to re-establish the safety I/O connection for a connection in which a safety I/O communications error has occurred. If the cause of the communications error is eliminated, safety I/O communications will restart automatically.

Mode after communications error	Description
Stop only the connection where the error occurred.	Specify this mode to keep safety I/O communications stopped on a connection in which a safety I/O communications error has occurred. I/O communications will continue for normal connections. To restart safety I/O communications for connections in which I/O communications have been stopped, use the Network Configurator to send a command to restart communications. It is also possible to write a logic routine in the user program in advance to turn ON the specified Safety I/O Communications Restart Flag and restart communications with a specified trigger bit.
Stop all connections	Specify this mode to stop safety I/O communications with all safety slaves stopped after a safety I/O communications error has occurred. To restart safety I/O communications with the safety slaves after I/O communications have been stopped, use the Network Configurator to send a command to restart communications. It is also possible to write a logic routine in the user program in advance to turn ON all of the Safety I/O Communications Restart Flags and restart communications with a specified trigger bit. This function is enabled when safety I/O communications are established with all Safety Slaves.

Resetting a Connection Stopped due to a Communications Error

When I/O communications have stopped in a connection due to a connection timeout, I/O communications can be restarted in the stopped connection by turning ON the Communications Reset Flag from the user program or sending a Communications Restart command from the Network Configurator. If the Controller communications mode is set to stop all connections after a communications error, communications cannot be restarted in a specified stopped connection. In this case, restart communications in all connections.

1. Restarting I/O Communications from the Network Configurator

After connecting online with the Network Configurator, select the Safety Master, right-click to display the popup menu, and select **Monitor** to display the Device Monitor Window. The following window will appear when the safety connection is selected.

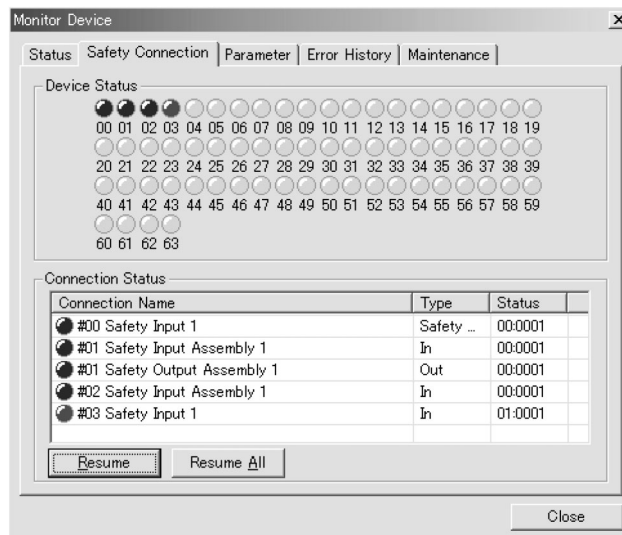

Communications can be restarted in a connection where an error occurred (evident from the connection status) by selecting that connection and clicking the **Resume** Button. If the **Resume All** Button is clicked, I/O communications will restart in all Slaves with which communications were stopped.

2. Restarting I/O Communications from the User Program

When the safety connection is set, the following user program output tags will be displayed for the connection.

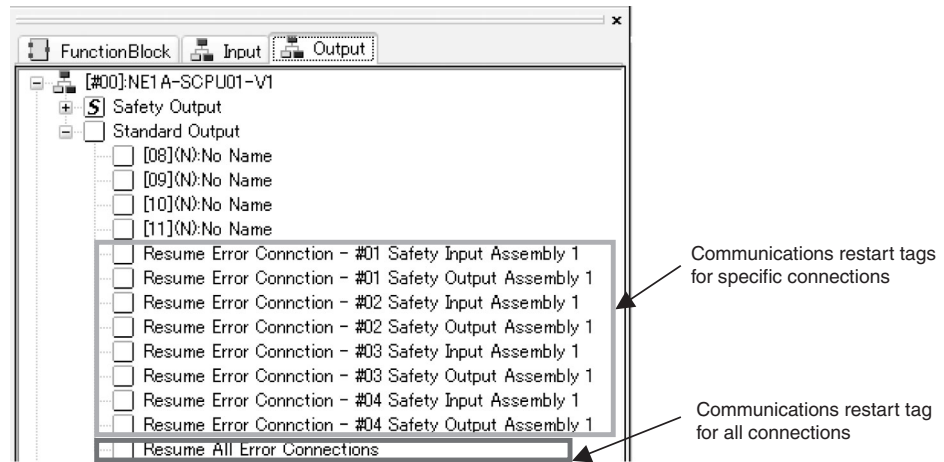

When these tags have been set in the user program in advance as I/O communications restart conditions, I/O communications can be restarted with these tags by turning ON (OFF → ON) the specified condition.

4-5 Safety Slave Function

4-5-1 Safety I/O Communications as Safety Slave

An NE1A-series Controller can function as a Safety Slave.

One NE1A-series Controller can function simultaneously as a Safety Master, Safety Slave, and Standard Slave.

The following steps are required in order for the NE1A-series Controller to perform safety I/O communications as a Safety Slave.

1. Creation of I/O data (safety slave I/O) to use as a Safety Slave
2. Registration in the Safety Master
3. Safety I/O connections settings in the Safety Master

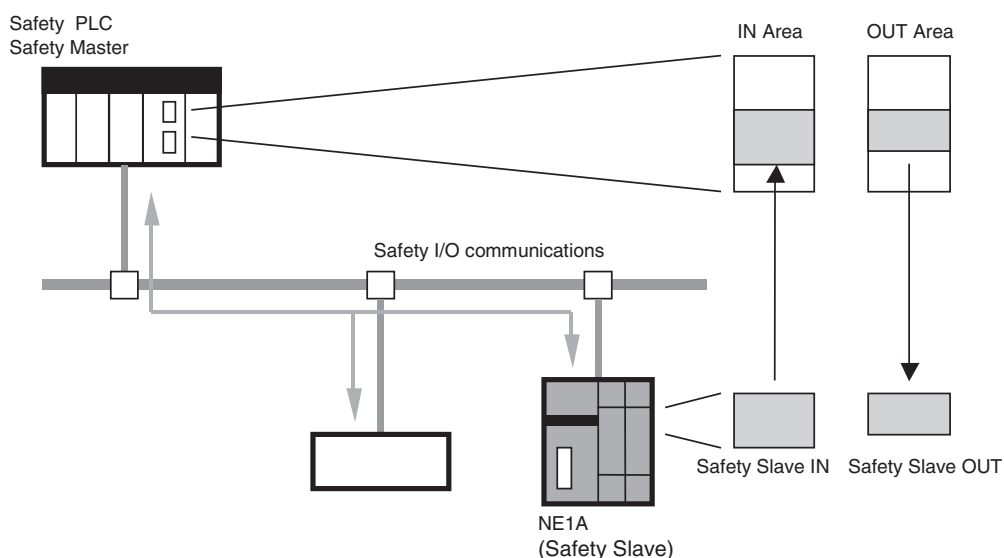

Safety Slave Specifications

Safety I/O Connections	
Number of connections	4 max.
Maximum data size	16 bytes of input or 16 bytes of output (per connection)
Connection type	Single cast or multicast (See note.)

Note Up to 15 masters total can be communicated with for one multicast connection.

4-5-2 Creating I/O Data (Safety Slave I/O) to Use as Safety Slave

The I/O data to be used by the Safety Slave must be created in order for the NE1A-series Controller to perform safety I/O communications as a Safety Slave. The memory block for this I/O data is called Safety Slave I/O.

- Up to four types of Safety Slave I/O can be created.
- The maximum data size for Safety Slave I/O is 16 bytes.
- The following status information can be included in I/O data if the I/O type of the Safety Slave I/O is Slave IN.
 - General Status
 - Local Input Status
 - Local Output Status
 - Test Output/Muting Lamp Status
- If the I/O type of the Safety Slave I/O is set to Slave IN for a NE1A-series Controller with unit version 1.0 or later (including Controllers that support EtherNet/IP), the following local I/O monitor data can also be included in the I/O data.
 - Local Input Monitor
 - Local Output Monitor

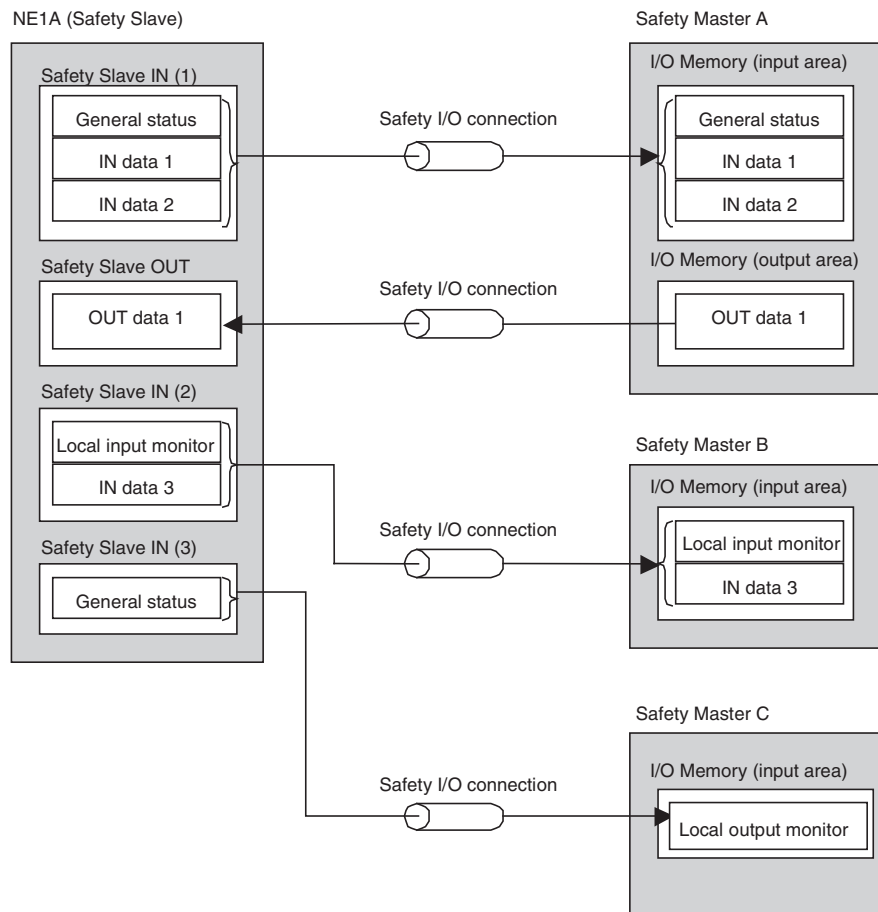

Safety Slave I/O Setting

Set the Safety Slave I/O as follows:

1. Select the I/O type.
2. Set the I/O tags.
3. Set additional status.
4. Set additional local I/O monitor data.

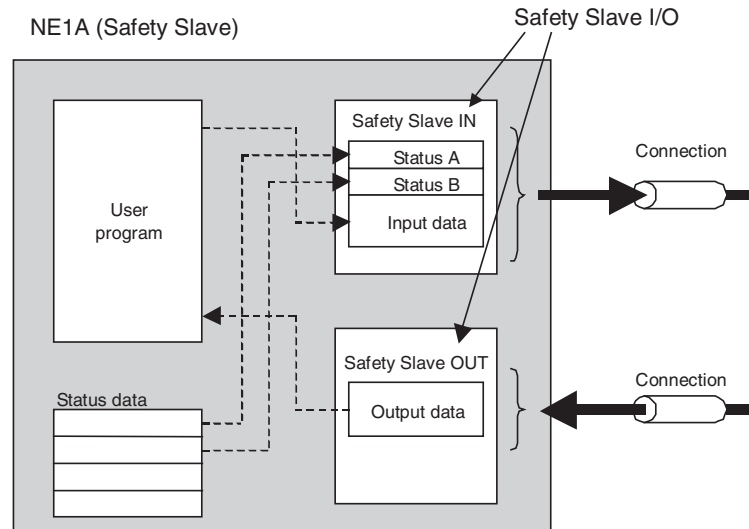

Selecting the I/O Type

I/O type	Description
Safety Slave IN	Data input from the network to the Safety Master.
Safety Slave OUT	Data output to the network from the Safety Master.

Setting I/O Tags

Set the input data blocks and output data blocks to use in the program for the Safety Slave I/O. Multiple data blocks can be set for Safety Slave I/O. The size of the data block can be selected from BOOL (1 byte), BYTE (1 byte), WORD (2 bytes), or DWORD (4 bytes). A maximum of 16 bytes, however, can be set for Safety Slave I/O.

I/O tags defined for data blocks can be used in the Logic Editor. Using I/O tags enables the user to program without being aware of the NE1A-series Controller’s specific memory addresses.

Setting Additional Status

When the I/O type of the Safety Slave I/O is Slave IN, the following status information can be added to the first line of the transmission data. Refer to 4-3-3 Remote I/O Area Data Configuration for details on each status.

Pre-Ver. 1.0 Controllers

Tag name	Data size	Attribute
General Status	Byte	Non-safety
Local Input Status	Word	Safety
Local Output Status	Byte	Safety
Test Output/Muting Lamp Status	Byte	Non-safety

Controllers with Unit Version 1.0 or Later, or Controllers that support EtherNet/IP with unit version 1.0 or later

Tag name	Data size	Attribute
General Status	Byte	Non-safety
Local Input Status 1 to N (See note.)	Byte	Safety
Local Output Status	Byte	Safety
Test Output/Muting Lamp Status 1 to M (See note.)	Byte	Non-safety

Note For the NE1A-SCPU01(-V1)/NE1A-SCPU01-EIP, N = 2 and M = 1. For the NE1A-SCPU02/NE1A-SCPU02-EIP, N = 5 and M = 2. The sizes of the local input status and test output/muting lamp status data can be specified in bytes.

Setting Local I/O Monitor Data

If the I/O type of the Safety Slave I/O is set to Slave IN for a NE1A-series Controller with unit version 1.0 or later (including Controllers that support EtherNet/IP), the following local I/O monitor information can be added to the transmission data after the status information. Refer to *4-3-3 Remote I/O Area Data Configuration* for details on the local I/O monitor information.

Local I/O Monitor	Data size	Attribute
Local Input Monitor 1 to N (See note.)	Byte	Safety
Local Output Monitor	Byte	Non-safety

Note For the NE1A-SCPU01(-V1)/NE1A-SCPU01-EIP, N = 2. For the NE1A-SCPU02/NE1A-SCPU02-EIP, N = 5. The size of the local input monitor data can be specified in bytes.

⚠ WARNING	
Serious injury may possibly occur due to loss of required safety functions. The necessary measures for safety data are not taken for data with the non-safety data attribute from NE1A-series Controller's internal status information allocated to the Safety Master. Therefore, do not use this data to configure the Safety Control System.	

4-6 Standard Slave Function

4-6-1 Standard I/O Communications as Standard Slave

An NE1A-series Controller can function as a Standard Slave. One NE1A-series Controller can function simultaneously as a Safety Master, Safety Slave, and Standard Slave.

The NE1A-series Controller’s internal status information is also included in the data allocated to the Standard Master, and so a monitoring system using a PLC can be established.

The following steps are required in order for an NE1A-series Controller to perform standard I/O communications as a Standard Slave.

1. Creation of I/O data (slave I/O) to use as a Standard Slave
2. Registration in the Standard Master
3. Connection settings in the Standard Master

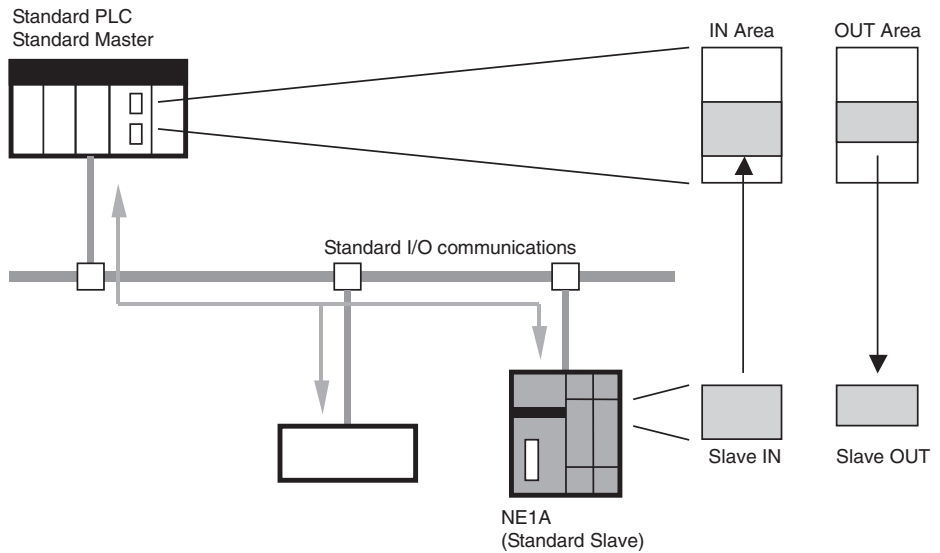

Standard Slave Specifications

Standard I/O Connections	
Number of connections	2 max.
Maximum data size	16 input bytes or 16 output bytes (per connection) (See note 1.)
Connection type	Poll, Bitstrobe, COS, or Cyclic

- Note**
- (1) The maximum data size is eight input bytes or zero outputs bytes when a Bitstrobe connection is selected.
 - (2) COS and cyclic connections cannot be used at the same time.
 - (3) When two Poll/COS or Poll/Cyclic connections are selected, the same output destination is used, so the maximum output data size is 16 bytes. For inputs, up to 32 bytes of data can be set for 2 connections.

4-6-2 Creating I/O Data (Slave I/O) to Use as Standard Slave

The I/O data to be used for the DeviceNet Slave must be created in order for an NE1A-series Controller to perform standard I/O communications as a Standard Slave. The memory blocks for this I/O data are called Slave I/O.

- Slave I/O blocks can be created for a maximum of 2 connections.
- The maximum data size for Slave I/O is 16 bytes.
- The following status information can be included in I/O data when the I/O type of the Slave I/O is slave input.
 - General Status
 - Local Input Status
 - Local Output Status
 - Test Output/Muting Lamp Status
- If the I/O type of the Safety Slave I/O is set to Slave IN for a NE1A-series Controller with unit version 1.0 or later (including Controllers that support EtherNet/IP), the following local I/O monitor data can also be included in the I/O data.
 - Local Input Monitor
 - Local Output Monitor

Setting Slave I/O

Set the Slave I/O as follows:

1. Select the connection type.
2. Set the I/O tags.
3. Set additional status.
4. Set additional local I/O monitor data.

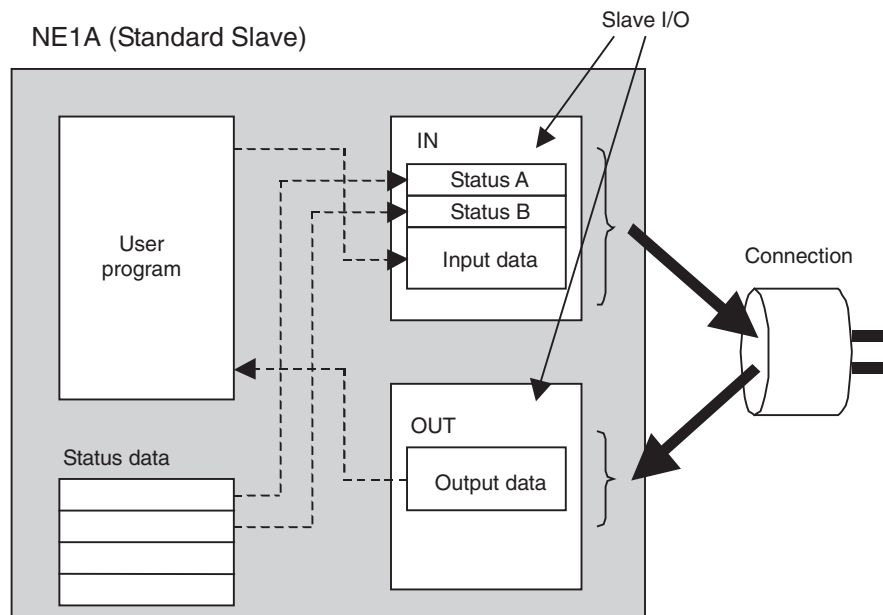

Selecting Connection Type

Any of the following 4 connection types can be selected. Output data cannot be set for Bitstrobe data because Bitstrobe data cannot be output from the Standard Master. Also, the maximum data size for Bitstrobe data input to Standard Master is 8 bytes. COS and cyclic connections cannot be used at the same time.

- Poll
- Bitstrobe
- COS
- Cyclic

Setting I/O Tags

Set the input data blocks and outputs data block to use for the selected connection. Multiple data blocks can be set for Slave I/O. The data block size can be selected from BOOL (1 byte), BYTE (1 byte), WORD (2 bytes), or DWORD (4 bytes). A maximum of 16 bytes, however, can be set for Slave I/O.

I/O tags defined for data blocks can be used in the Logic Editor. Using I/O tags enables the user to program without being aware of the specific memory addresses in the NE1A-series Controller.

Setting Additional Status

When the I/O type of a Slave I/O is Slave IN, the following status information can be added to the first line of the transmission data. Refer to *4-3-3 Remote I/O Area Data Configuration* for details on each status.

Pre-Ver. 1.0 Controllers

Tag Name	Data Size
General Status	Byte
Local Input Status	Word
Local Output Status	Byte
Test Output/Muting Lamp Status	Byte

Controllers with Unit Version 1.0 or Later, Including Controllers that Support EtherNet/IP

Tag Name	Data Size
General Status	Byte
Local Input Status 1 to N (See note.)	Byte
Local Output Status	Byte
Test Output/Muting Lamp Status 1 to N (See note.)	Byte

Note For the NE1A-SCPU01(-V1)/NE1A-SCPU01-EIP, N = 2 and M = 1. For the NE1A-SCPU02/NE1A-SCPU02-EIP, N = 5 and M = 2. The sizes of the local input status and test output/muting lamp status data can be specified in bytes.

Setting Local I/O Monitor Data

If the I/O type of the Safety Slave I/O is set to Slave IN for a NE1A-series Controller with unit version 1.0 or later (including Controllers that support EtherNet/IP), the following local I/O monitor information can be added to the transmission data after the status information. Refer to *4-3-3 Remote I/O Area Data Configuration* for details on the local I/O monitor information.

Local I/O Monitor	Data size
Local Input Monitor 1 to N (See note.)	Byte
Local Output Monitor	Byte

Note For the NE1A-SCPU01(-V1)/NE1A-SCPU01-EIP, N = 2. For the NE1A-SCPU02/NE1A-SCPU02-EIP, N = 5. The sizes of the local input status and local input monitor status data can both be specified in bytes.

 **WARNING**

Serious injury may possibly occur due to loss of required safety functions. The data attributes handled by standard I/O communications are non-safety data. The necessary measures for safety data are not taken for this data during data generation. Therefore, do not use this data to configure the Safety Control System.



SECTION 5

Ethernet Communications

5-1	Connecting to Ethernet	104
5-1-1	Setting the IP Address	104
5-1-2	TCP/IP Settings	105
5-2	EtherNet/IP Communications	108
5-2-1	Standard I/O Communications as Standard Target	108
5-2-2	Creating I/O Data (Target I/O) to Use as Standard Target	108
5-3	UDP/IP Message Communications.	112
5-3-1	Overview of Device Access Using UDP/ IP Message Communications	112
5-3-2	UDP/IP Message Format	112

5-1 Connecting to Ethernet

5-1-1 Setting the IP Address

You can use either of the following methods to set the IP address for an NE1A-series Controller that supports EtherNet/IP.

Method 1: Acquiring the IP Address from a BOOTP Server

(This is the default mode for NE1A-series Controllers that support EtherNet/IP.)

Use this setting method when it is possible to connect a BOOTP server to the network.

Method 2: Using the Network Configurator to Make the TCP/IP Settings

An NE1A-series Controller that supports EtherNet/IP will operate in the state shown below when power is turned ON while the IP address display switch is pressed.

Setting	Operating status
IP address	192.168.250.1
Subnet mask	255.255.255.0 (Class C mask status)
Default gateway	None (IP routing disabled)
Preferred DNS server	None
Alternate DNS server	None
Host name	None
Domain name	None
Baud rate	Auto-detect

Use this setting method when it is not possible to connect a BOOTP server to the network.

Method 1: Acquiring the IP Address from a BOOTP Server

The default mode for NE1A-series Controllers that support EtherNet/IP is for the Controller to be started with the IP address acquired from a BOOTP server. In this mode, the IP address can be automatically acquired from the BOOTP server.

Obtaining a BOOTP Server Running on a Personal Computer

The Rockwell Interactive BOOTP/DHCP Utility is the BOOTP server recommended by ODVA. It can be downloaded from the following site:

<http://www.ab.com/networks/bootp.html>

The MAC address may be required to set the BOOTP server. The MAC address is given on the nameplate on the front of the Unit.

Method 2: Using the Network Configurator to Make the TCP/IP Settings

When an NE1A-series Controller that supports EtherNet/IP is started with the IP address switch pressed, the default is for the Controller to be given a starting IP address of 192.168.250.1. After the Controller has started with this IP address, the Network Configurator can be used to make the TCP/IP settings, including the IP address. For details, refer to *5-1-2 TCP/IP Settings*.

IMPORTANT When an NE1A-series Controller that supports EtherNet/IP is started with the IP address switch pressed, the Controller will be given a fixed starting IP address of 192.168.250.1. When starting the Controller in this mode, set the IP address before executing any other operations.

5-1-2 TCP/IP Settings

Using the Network Configurator to Make the Settings

- 1,2,3...
1. Select **Programs - OMRON Network Configurator for DeviceNet Safety - Network Configurator** from the Windows Start Menu. The Network Configurator will start.
 2. Connect the Network Configurator online. (Select **Option - Select - Interface** to set the interface, and then select **Network - Connect**.)
 3. Select EtherNet/IP in the Network Configuration Window. (Example: Click the **EtherNet/IP_1** Tab.)
 4. Select **Tools - TCP/IP Settings**. The Setup TCP/IP Configuration Dialog Box will be displayed. The default settings are given in the dialog box shown below.

5. In the *Target IP Address*, set the present IP address for the applicable NE1A-series Controller.

- To change the IP address, select the *Use the following IP address* Option and set the IP address.



- Click the **Set to the Device** Button. The NE1A-series Controller will automatically begin using the updated settings for operation.

IMPORTANT Before downloading, confirm the device that is to be connected. If the node address (the IP address) is not set correctly, an unintended device may be connected and incorrect device parameters may be set.

IMPORTANT DNS is not supported for NE1A-series Controllers. In the TCP/IP settings, the *Do not use DNS* Option must be selected.

TCP/IP Setting Details

The NE1A-series Controller’s TCP/IP Configuration settings include the following settings.

- IP address
- Subnet mask
- Default gateway
- Baud rate

IP Address

Sets the NE1A-series Controller’s local IP address.

Default IP address = 192.168.250.1

Subnet Mask

For the subnet mask, all bits corresponding to the bits in the IP address used as either the net number or the subnet number are set to 1, and the bits corresponding to the host number are set to 0. These settings must be made when using an address conversion method other than the IP address table method.

If no subnet mask is set, or if an illegal value is set, the following values will be used depending on the IP address class.

Class	Subnet mask
Class A	255.0.0.0
Class B	255.255.0.0
Class C	255.255.255.0

With the default setting (0.0.0.0), a subnet mask corresponding to the IP address class is used.

The following table shows the various Unit settings when only the IP Address Display/Setting Area is set, and the other TCP/IP Configuration settings are left at their default values.

Setting	Operating status
IP address	Set with the Network Configurator.
Subnet mask	Set with the Network Configurator.
Default gateway	None (IP routing disabled)
Preferred DNS server	None
Alternate DNS server	None
Host name	None
Domain name	None
Baud rate	Auto-detect

Default Gateway

Sets the default gateway’s IP address.
When not using the default gateway, set 0.0.0.0.

Link Setting

Sets the communications baud rate.

Setting	Meaning
Auto (default)	The baud rate with the switching hub is detected automatically. If possible, the Unit operates in 100BASE-T (full duplex).
10 Mbps, Half Duplex	Operates in 10BASE-T, half duplex.
10 Mbps, Full Duplex	Operates in 10BASE-T, full duplex.
100 Mbps, Half Duplex	Operates in 100BASE-TX, half duplex.
100 Mbps, Full Duplex	Operates in 100BASE-TX, full duplex.

Note Adjust the link settings of the NE1A-series Controller to match the communications settings of the connected switching hub. If the settings do not match, the link will become unstable and prevent normal communications. NE1A link settings are not enabled immediately. After you set the links, cycle the power supply to or reset the NE1A Safety Network Controller. To reset the NE1A Safety Network Controller from the Network Configurator, first close the Setup TCP/IP Configuration Dialog Box, and then select the Controller in the Network Configuration Window and reset it. For EtherNet/IP I/O communications (tag data link communications) with an EtherNet/IP standard originator, it is recommended that auto-negotiation or 100M full-duplex communications be set for the Controller and the switching hubs.

NE1A-series Controller		Auto-negotiation	10 Mbps		100 Mbps	
Switching hub			Full	Half	Full	Half
Auto-negotiation		Recommended	Not connectible	Connectible	Not connectible	Connectible
10 Mbps	Full	Not connectible	Connectible	Not connectible	Not connectible	Not connectible
	Half	Connectible	Not connectible	Connectible	Not connectible	Not connectible
100 Mbps	Full	Not connectible	Not connectible	Not connectible	Recommended	Not connectible
	Half	Connectible	Not connectible	Not connectible	Not connectible	Connectible

5-2 EtherNet/IP Communications

5-2-1 Standard I/O Communications as Standard Target

An NE1A-series Controller can function as a Standard Target.

The NE1A-series Controller’s internal status information is also included in the data allocated to the Standard Originator, and so a monitoring system using a PLC can be established.

The following steps are required in order for an NE1A-series Controller to perform standard I/O communications as a Standard Target.

1. Creation of I/O data (Target I/O) to use as a Standard Target
2. Registration in the Standard Originator
3. Connection settings in the Standard Originator

For details on how to make the settings, refer to the *DeviceNet Safety System Configuration Manual* (Cat. No. Z905).

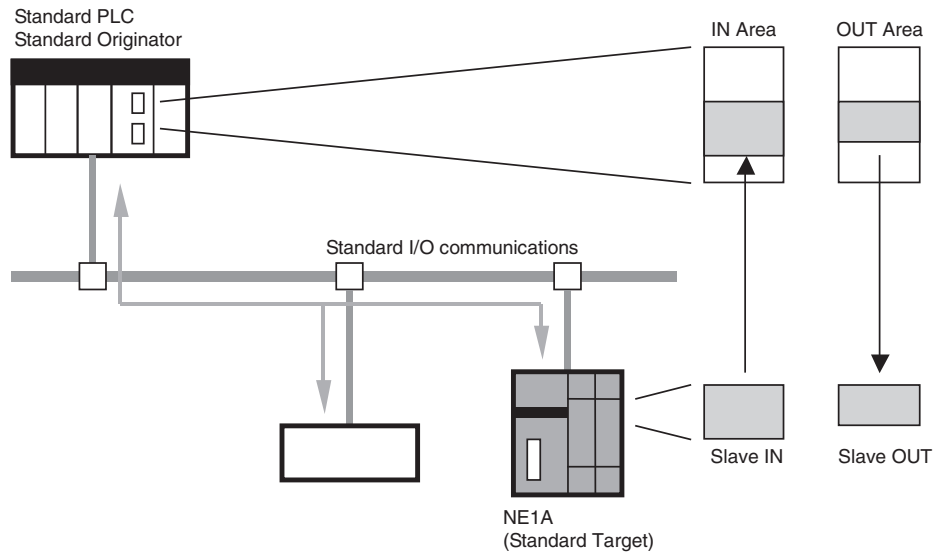

Standard Target Specifications

Standard I/O Connections	
Number of connections	2 max.
Maximum data size	128 input bytes or 16 output bytes per connection
Connection type	Point-to-point or multicast

IMPORTANT For an NE1A-series Controller, do not set a connection through an open network.

5-2-2 Creating I/O Data (Target I/O) to Use as Standard Target

The I/O data to be used for the Standard Target must be created in order for an NE1A-series Controller to perform standard I/O communications as a Standard Target.

- Target I/O blocks can be created for a maximum of 2 connections.
- The maximum data size for Target I/O is 128 input bytes or 16 output bytes.

- The following status information can be included in I/O data when the I/O type of the Target I/O is input.
 - General Status
 - Local Input Status
 - Local Output Status
 - Test Output/Muting Lamp Status
 - Local Input Monitor
 - Local Output Monitor
- When the I/O type of a Target I/O is Target IN, data for communications between this Unit and a Safety Slave performing DeviceNet Safety communications can be included in the I/O data.

IMPORTANT When connected to an OMRON CS/CJ-series EtherNet/IP Communications Unit, I/O communications for EtherNet/IP are set in 2-byte increments. When creating an odd number of bytes of I/O data, add one byte to the I/O tag to make it an even number.

Setting Target I/O

Set the Target I/O as follows:

1. Select the connection type.
2. Set the I/O tags.
3. Set additional status.
4. Set additional local I/O monitor data.
5. Set Safety I/O routing.

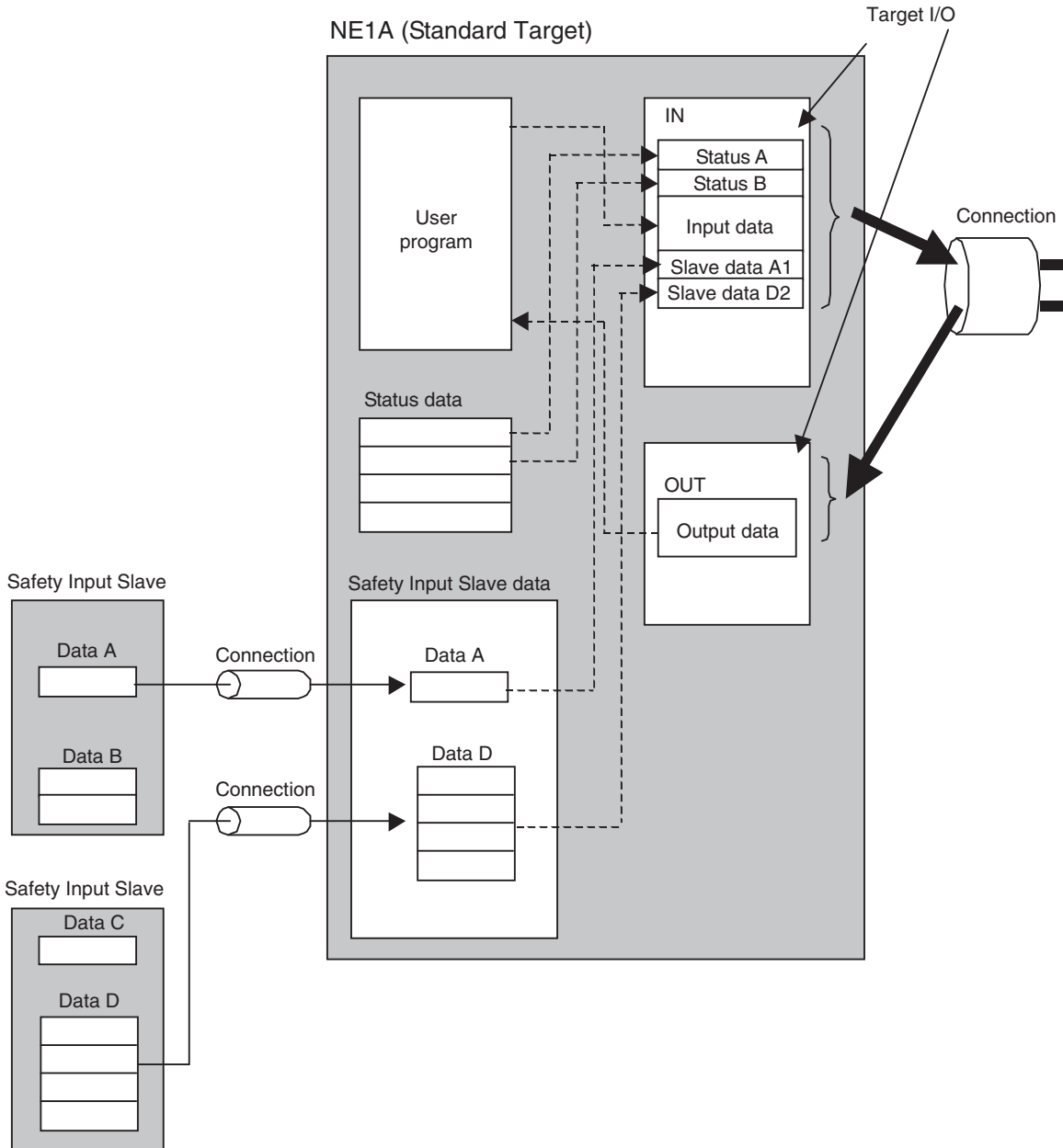

IMPORTANT If Safety Input Slave data is to be handled by the Originator using Target I/O communications, the data must be set for DeviceNet Safety I/O communications. For details on making the settings, refer to 4-4-2 Safety I/O Connection Settings.

Selecting the I/O Type

Any of the following 2 connection types can be selected.

- Point-to-point
- Multicast

Setting Additional Status

When the I/O type of a Target I/O is Target IN, the following status information can be added to the first line of the transmission data. The contents of the status are the same as for DeviceNet communications. Refer to *4-3-3 Remote I/O Area Data Configuration* for details on each status.

Tag Name	Data Size
General Status	Byte
Local Input Status 1 to N ^{*1}	Byte
Local Output Status	Byte
Test Output/Muting Lamp Status 1 to M ^{*1}	Byte

- *1 For the NE1A-SCPU01-EIP, N = 2 and M = 1. For the NE1A-SCPU02-EIP, N = 5 and M = 2. The sizes of the local input status and test output/muting lamp status data can be specified in bytes.

Setting Local I/O Monitor Data

If the I/O type of the Target I/O is set to Target IN for a NE1A-series Controller the following local I/O monitor information can be added to the transmission data after the status information. Refer to *4-3-3 Remote I/O Area Data Configuration* for details on the local I/O monitor information.

Local I/O Monitor	Data size
Local Input Monitor 1 to N ^{*1}	Byte
Local Output Monitor	Byte

- *1 For the NE1A-SCPU01-EIP, N = 2. For the NE1A-SCPU02-EIP, N = 5. The sizes of the local input status and local input monitor status data can both be specified in bytes.

Setting I/O Tags

Set the input data blocks and outputs data block to use for the selected connection. Multiple data blocks can be set for Target I/O. The data block size can be selected from BOOL (1 byte), BYTE (1 byte), WORD (2 bytes), or DWORD (4 bytes). A maximum of 16 input bytes or 16 output bytes, however, can be set for the Target I/O.

I/O tags defined for data blocks can be used in the Logic Editor. Using I/O tags enables the user to program without being aware of the specific memory addresses in the NE1A-series Controller.

Setting Safety I/O Routing

When the I/O type of a Target I/O is Target IN, data for communications between with a Safety Slave performing DeviceNet Safety communications can be added after the I/O tags.

WARNING

Serious injury may possibly occur due to loss of required safety functions. The data attributes handled by standard I/O communications are non-safety data. The necessary measures for safety data are not taken for this data during data generation. Therefore, do not use this data to configure the Safety Control System.



5-3 UDP/IP Message Communications

5-3-1 Overview of Device Access Using UDP/IP Message Communications

Devices on DeviceNet or DeviceNet Safety network can be accessed from general-purpose controllers (PLCs, computers, etc.) on Ethernet network using UDP/IP frame message communications via NE1A-series Controllers (Controllers with EtherNet/IP and unit version 1.1 or later).

This enables monitoring a DeviceNet or DeviceNet Safety control system via Ethernet from a machine controller or monitor computer that does not support a DeviceNet interface or an EtherNet/IP interface.

This enables easily adding a DeviceNet Safety control system to an existing system.

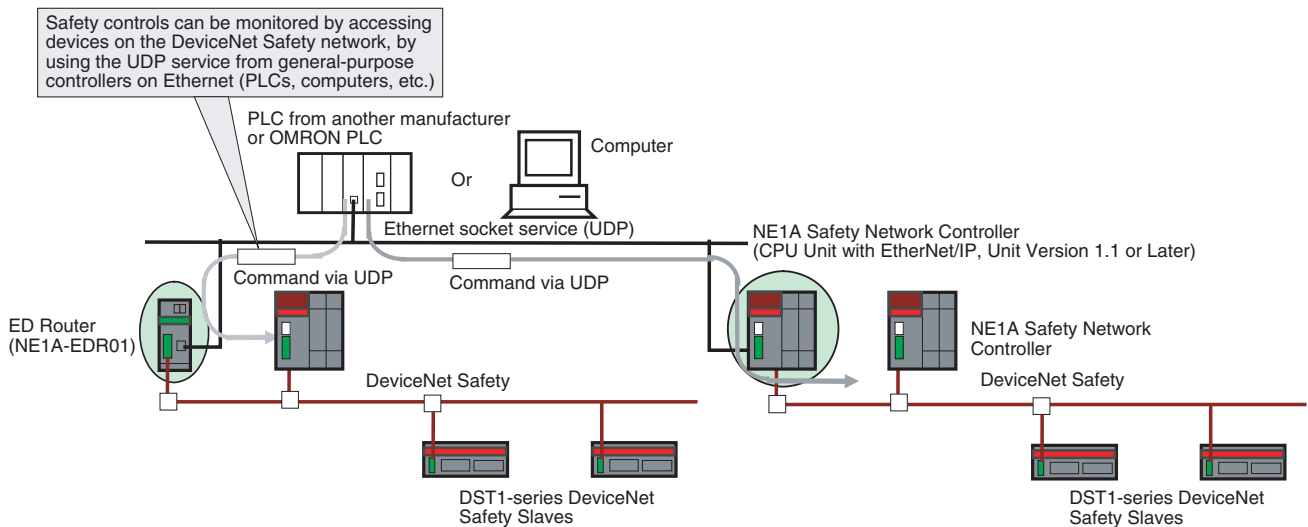

■ UDP/IP Message Communications Specifications

Only NE1A-series CPU Units with EtherNet/IP (unit version 1.1 or later) support the UDP/IP communications message service.

UDP/IP Message Communications	
Number of resources	Server: Four message buffers Client: None
Maximum message size	Command: 492 bytes Responses: 496 bytes
UDP port number	Always 64000 (FA00 hex)

5-3-2 UDP/IP Message Format

Command Format

The following format is used to send commands (i.e., UDP/IP messages) from a device on Ethernet. The least-significant byte for multi-byte parameters is in the lower address.

When the NE1A-series Controller (CPU Unit with EtherNet/IP, unit version 1.1 or later) receives a command from a device on Ethernet, an explicit message is sent to the destination node on DeviceNet. This is the same for a command addressed to the Controller with EtherNet/IP. Access it by using the node address on DeviceNet.

+0	Message sequence number	2 bytes
+2	Timeout monitor time	2 bytes
+4	Data size	2 bytes
+6	Destination node address	1 byte
+7	Service code	1 byte
+8	Class ID	2 bytes
+10	Instance ID	2 bytes
+12	Data	492 bytes max.

Parameter	Description
Message sequence number	Numbers are set to differentiate frames when there is more than one send frame. An arbitrary value is assigned by the device that sends the message. The same value is stored in the corresponding response. Setting range: 0 to 65535
Timeout monitor time	The timeout monitor time for the NE1A-series Controller (CPU Unit with EtherNet/IP, unit version 1.1 or later) to use for monitoring is set. The setting unit is 10 ms. The default value of 10 s is used if the setting is 0. The device that sends the message must monitor for timeouts using a longer time than the value that is set here. Setting range: 0 to 65535 (maximum: 655 s)
Data size	The data size from the destination node address to the end of the data is set. The unit is bytes. Setting range: 6 to 498
Destination node address	The address of the destination node on DeviceNet is set. Setting range: 0 to 63
Service code	The service code for the destination object is set. The service code that is set here is sent to the destination node as is.
Class ID	The class ID of the destination object is set. The class ID that is set here is sent to the destination node as is.
Instance ID	The instance ID of the destination object is set. The instance ID that is set here is sent to the destination node as is.
Data	The data is set here. The data that is set depends on the service code.

Note Refer to *Appendix 3: Explicit Messages* for details on the services that are provided by the NE1A-series Controller.

Response Format

When a response is returned from the destination device on the DeviceNet network, the NE1A-series Controller (CPU Unit with EtherNet/IP, unit version 1.1 or later) sends the response (i.e., a UDP/IP message) to the device on Ethernet that sent the command.

The response format is shown below.

+0	Message sequence number	2 bytes
+2	Data size	2 bytes
+4	Destination node address	1 byte
+5	Service code	1 byte
+6	Data	496 bytes max.

Parameter	Description
Message sequence number	The sequence number that was set when the command was sent is returned.
Data size	The data size from the destination node address to the end of the data is stored. The unit is bytes. Range: 2 to 498
Destination node address	The node address of the designation device on DeviceNet (the send destination address) is stored.
Service code	The service code for the destination object that was set when the command was sent is stored. For a normal response, the most-significant bit in the requested service code is turned ON. For an error response, 94 hex is stored.
Data	The response data is stored. If there is an error response, the following data is returned. <ul style="list-style-type: none"> • General Error Code (1 byte) • Additional Error Code (1 byte)

SECTION 6

Explicit Message Communications

6-1	Receiving Explicit Messages	116
6-1-1	Overview.....	116
6-1-2	NE1A-series Controller I/O Area Read	116
6-2	Sending Explicit Messages	124
6-2-1	Overview.....	124
6-2-2	Procedure	124
6-2-3	Restrictions.....	125

6-1 Receiving Explicit Messages

6-1-1 Overview

Sending explicit messages from the Standard Master to the NE1A-series Controller enables reading or writing any specified data or parameters of the Controller. The Controller operates according to the command sent from the master and returns a response. This function can be used with both DeviceNet and EtherNet/IP.

The following example describes the I/O area read service provided by the Controller.

How to use read/write messages for EtherNet/IP target I/O areas is also described (newly supported for CPU Units with EtherNet/IP, unit version 1.1 or later).

- Note**
- Refer to *Appendix 3: Explicit Messages* for details on the services that are available.
 - The format shown here for explicit messages is the format used on the network. Refer to the operation manual of the Standard Master for specific setting methods for each Standard Master.

6-1-2 NE1A-series Controller I/O Area Read

Reads the NE1A-series Controller’s local I/O or the Safety Slave I/O area allocated to the Controller from the master.

Command Format

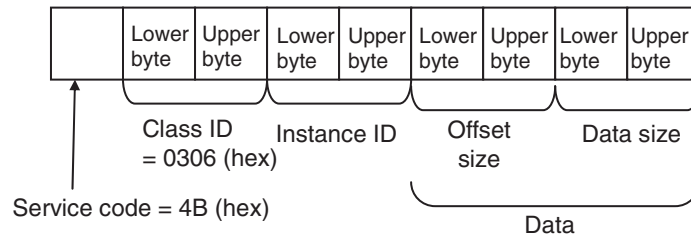

Response Format

- Normal Response to Explicit Message

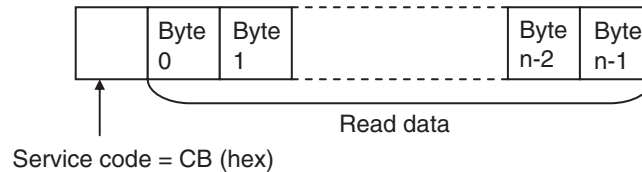

- Error Response to Explicit Message

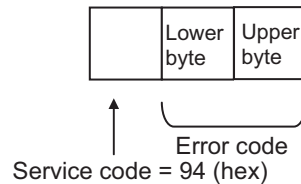

Service Code (Command/Response)

For commands, 4B hex is specified. For responses, the upper bit is turned ON, and CB hex is returned.

Class ID (Command)

0306 hex.

Instance ID (Command)

Explicit message	Service	Instance ID
Read Local Input Area	Read	0001 hex
Read Local Output Area	Read	0002 hex
Read Safety Remote Input Area	Read	0005 hex
Read Safety Remote Output Area	Read	0006 hex

Data (Command)

Offset size Specifies the address from which to start reading. This is an offset in bytes from the first line of the area.

Data size Specifies in number of bytes to read (1 to 48 bytes)

Range Local Input Area: 0 or 1 (Pre-Ver. 1.0 Controllers)
 0 or 1 (NE1A-SCPU01(-V1), NE1A-SCPU01-EIP)
 0 to 5 (NE1A-SCPU02, NE1A-SCPU02-EIP)

Local Output/Test Output Area: 0 or 1

Safety Remote Input Area: 0 to 511

Safety Remote Output Area: 0 to 511

The I/O addresses of memory information that has been read can be checked on the Memory Info. Tab Page of the Edit Device Parameters Dialog Box for the NE1A-series Controller.

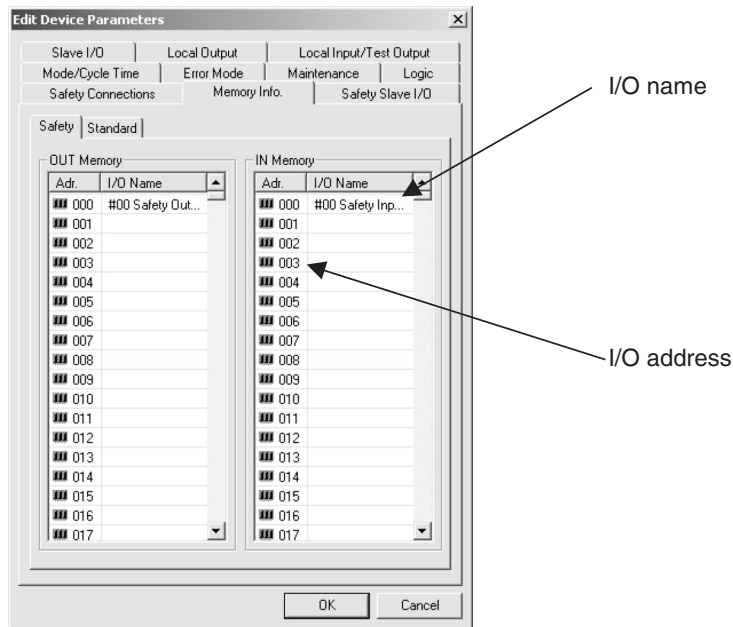

Read Data (Response)

The I/O data from the specified area is returned.

The address offsets and bit assignments for reading the local inputs, local outputs, and test outputs are given in the following tables.

• Local Inputs (6 Bytes)

Offset (bytes)	Bit 7	Bit 6	Bit 5	Bit 4	Bit 3	Bit 2	Bit 1	Bit 0
+0	Safety input terminal No.7	Safety input terminal No.6	Safety input terminal No.5	Safety input terminal No.4	Safety input terminal No.3	Safety input terminal No.2	Safety input terminal No.1	Safety input terminal No.0
+1	Safety input terminal No.15	Safety input terminal No.14	Safety input terminal No.13	Safety input terminal No.12	Safety input terminal No.11	Safety input terminal No.10	Safety input terminal No.9	Safety input terminal No.8
+2	Reserved				Safety input terminal No.19	Safety input terminal No.18	Safety input terminal No.17	Safety input terminal No.16
+3	Safety input terminal No.27	Safety input terminal No.26	Safety input terminal No.25	Safety input terminal No.24	Safety input terminal No.23	Safety input terminal No.22	Safety input terminal No.21	Safety input terminal No.20
+4	Safety input terminal No.35	Safety input terminal No.34	Safety input terminal No.33	Safety input terminal No.32	Safety input terminal No.31	Safety input terminal No.30	Safety input terminal No.29	Safety input terminal No.28
+5	Reserved				Safety input terminal No.39	Safety input terminal No.38	Safety input terminal No.37	Safety input terminal No.36

Note For the NE1A-SCPU01(-V1) or NE1A-SCPU01-EIP, status can be read for 16 terminals, i.e., safety input terminals No. 0 to 15. For the NE1A-SCPU02 or NE1A-SCPU02-EIP, status can be read for 40 terminals, safety input terminals No. 0 to 39.

• Local Outputs and Test Outputs (2 Bytes)

Offset (bytes)	Bit 7	Bit 6	Bit 5	Bit 4	Bit 3	Bit 2	Bit 1	Bit 0
0	Safety output terminal No.7	Safety output terminal No.6	Safety output terminal No.5	Safety output terminal No.4	Safety output terminal No.3	Safety output terminal No.2	Safety output terminal No.1	Safety output terminal No.0
1	Test output terminal No.7	Test output terminal No.6	Test output terminal No.5	Test output terminal No.4	Test output terminal No.3	Test output terminal No.2	Test output terminal No.1	Test output terminal No.0

Note For the NE1A-SCPU01(-V1) or NE1A-SCPU01-EIP, test output status can be read for 4 terminals, i.e., test output terminals No. 0 to 3. For the NE1A-SCPU02 or NE1A-SCPU02-EIP, test output status can be read for 8 terminals, i.e., test output terminals No. 0 to 7.

Error Code (Response)

The following error codes defined in DeviceNet may be returned.

Response code	Error name	Cause
08FF	Service not supported	Error in the service code.
13FF	Not enough data	The data is shorter than the specified size.
15FF	Too much data	The data is longer than the specified size.
16FF	Object does not exist	The specified class ID or instance ID is not supported.
20FF	Invalid parameter	The specified operation command data is not supported.

6-1-3 Reading NE1A EtherNet/IP Target I/O Areas

With an NE1A-series Controller with EtherNet/IP (unit version 1.1 or later), standard I/O communications targets can be set for EtherNet/IP to read EtherNet/IP standard I/O areas from explicit message clients without using a dedicated EtherNet/IP standard originator.

Command Format

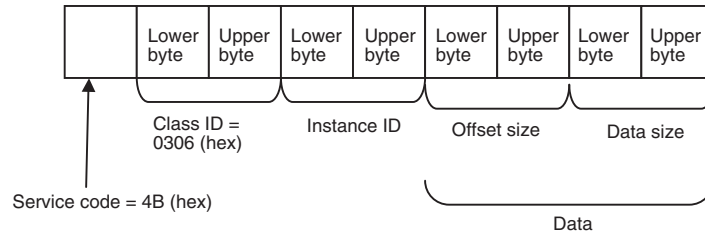

Response Format

- Normal Response to Explicit Message

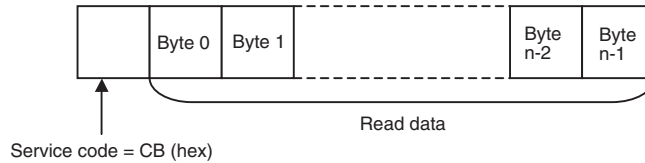

- Error Response to Explicit Message

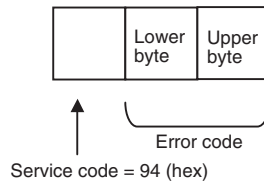

Service Code (Command/Response)

For commands, specify 4B hex.
For responses, the upper bit is turned ON, and CB hex is returned.

Class ID (Command)

Specify 306 hex as the class ID.

Instance ID (Command)

The instance ID specifies the area to read.

Explicit message	Service	Instance ID
Read EtherNet/IP Target Output 1 Area	Read	0010 hex
Read EtherNet/IP Target Output 2 Area	Read	0011 hex
Read EtherNet/IP Target Input 1 Area	Read	0012 hex
Read EtherNet/IP Target Input 2 Area	Read	0013 hex

Data (Command)

Offset size: Specifies the address from which to start reading.
This is an offset in bytes from the first line of the area.

Data size: Specifies the number of bytes to read.
(1 to 128 bytes)

Range: EtherNet/IP Target Output 1/2 Area: 0 to 15
EtherNet/IP Target Input 1/2 Area: 0 to 127

The I/O addresses to read can be checked on the Network Configurator on the EtherNet/IP Target I/O Tab Page of the Edit Device Parameters Dialog Box for the NE1A-series Controller.

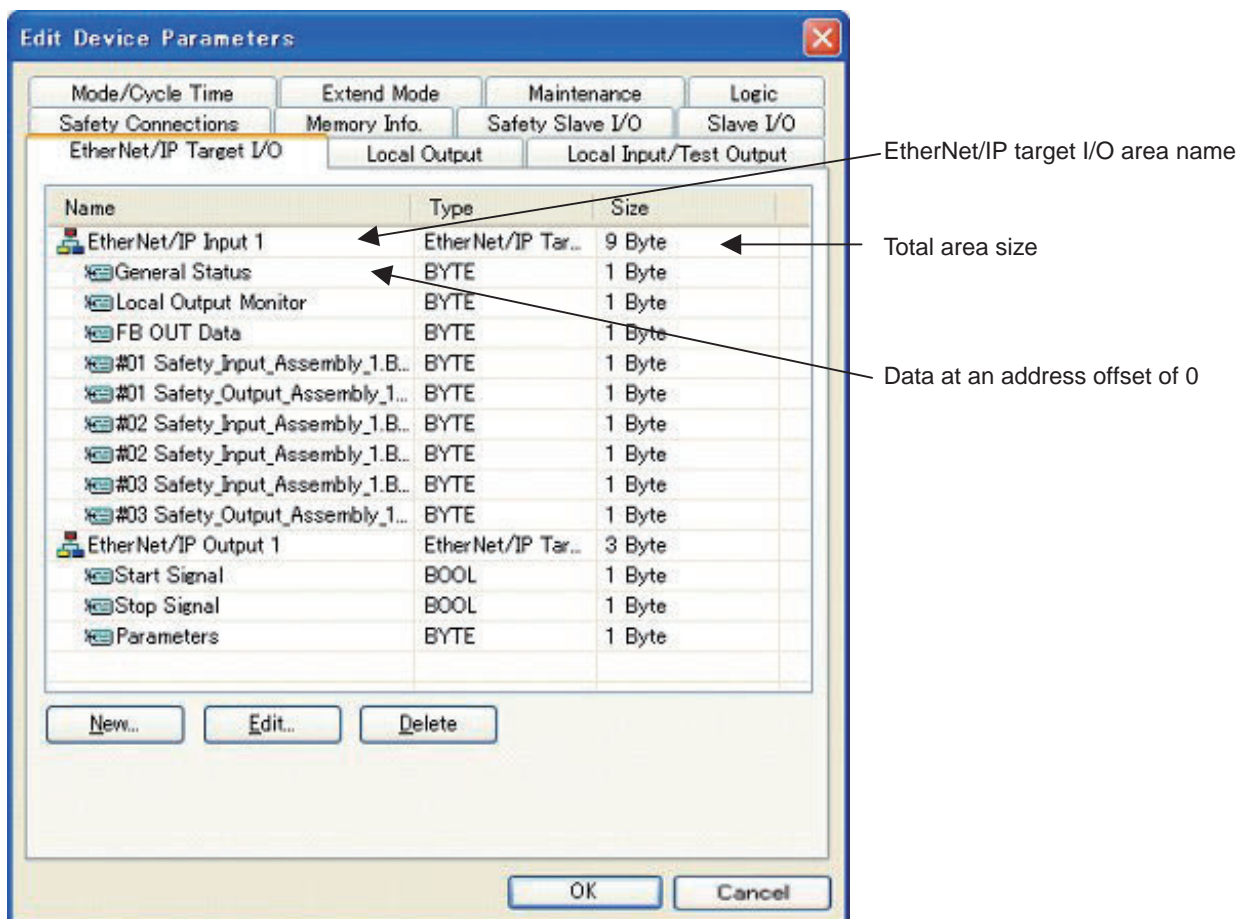

Read Data (Response)

The I/O data from the specified area is returned.

Error Code (Response)

The following error codes may be returned.

Response code	Error name	Cause
0CFF	Object state conflict	The specified EtherNet/IP target I/O is not set.
10FF	Device state conflict	The device is not in IDLE mode or RUN mode.
13FF	Not enough data	The data is shorter than the specified size.
15FF	Too much data	The data is longer than the specified size.
20FF	Invalid parameter	Reading was attempted for a specified EtherNet/IP target area address that is out of range.

6-1-4 Writing NE1A EtherNet/IP Target I/O Areas

With an NE1A-series CPU Unit with EtherNet/IP (unit version 1.1 or later), standard I/O communications targets can be set for EtherNet/IP to write EtherNet/IP standard I/O areas from explicit message clients without using a dedicated EtherNet/IP standard originator.

If the EtherNet/IP standard I/O area is being used in communications with the EtherNet/IP standard originator, writing the I/O area will end in an error because I/O communications are given priority.

Note To perform exclusive control to prevent more than one client from writing the same EtherNet/IP target output area at the same time, refer to *Appendix 5: Exclusive Control of Writing NE1A EtherNet/IP Target I/O Areas*.

Command Format

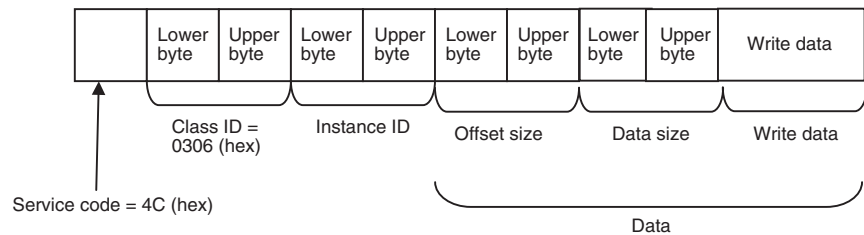

Response Format

- Normal Response to Explicit Message

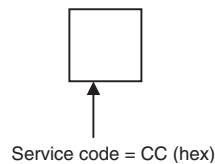

- Error Response to Explicit Message

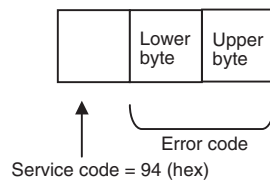

Service Code (Command/Response)

For commands, specify 4C hex.
 For responses, the upper bit is turned ON, and CC hex is returned.

Class ID (Command)

Specify 306 hex as the class ID.

Instance ID (Command)

The instance ID specifies the area to write.

Explicit message	Service	Instance ID
Write EtherNet/IP Target Output 1 Area	Write	0010 hex
Write EtherNet/IP Target Output 2 Area	Write	0011 hex

Data (Command)

Offset size: Specifies the address from which to start writing.
 This is an offset in bytes from the first line of the area.

Data size: Specifies the number of bytes to write.
 (1 to 16 bytes)

Range: EtherNet/IP Target Output 1/2 Area 0 to 15

Write data: The amount of data that is specified for the data size is specified.

The I/O addresses to write can be checked on the Network Configurator on the EtherNet/IP Target I/O Tab Page of the Edit Device Parameters Dialog Box for the NE1A-series Controller.

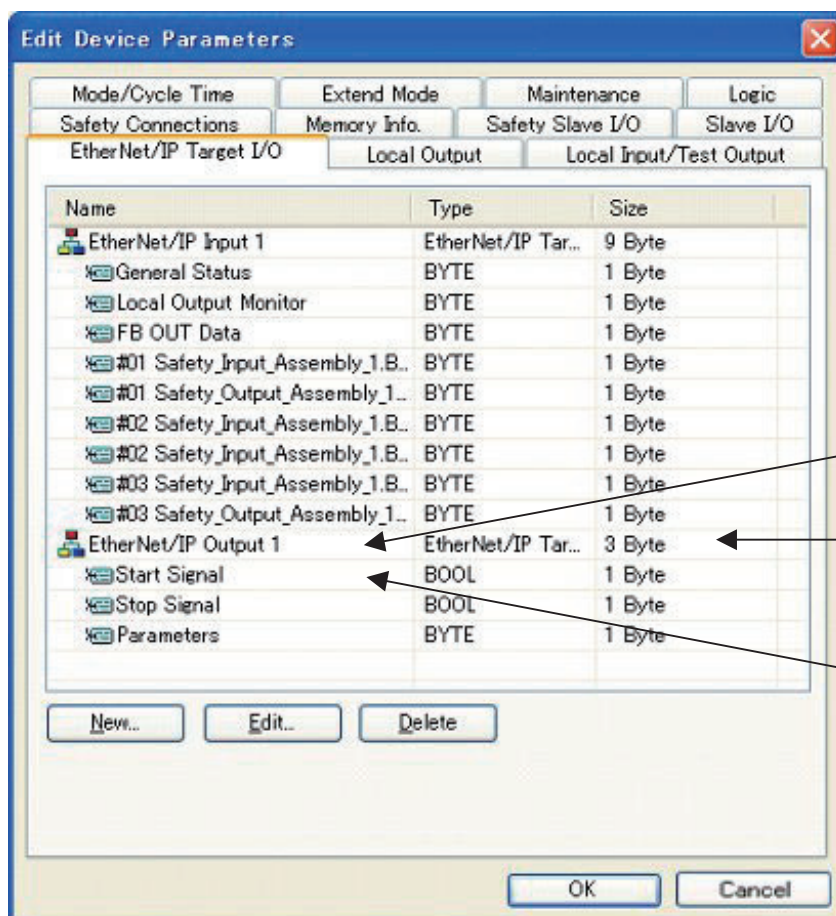

EtherNet/IP target I/O area name

Total area size

Data at an address offset of 0

Error Code (Response)

The following error codes may be returned.

Response code	Error name	Cause
0CFF	Object state conflict	The specified EtherNet/IP target I/O is not set. The specified EtherNet/IP target I/O area is being used for I/O communications with the standard originator.
10FF	Device state conflict	The device is not in IDLE mode or RUN mode.
13FF	Not enough data	The data is shorter than the specified size.
15FF	Too much data	The data is longer than the specified size.
20FF	Invalid parameter	Writing was attempted for a specified EtherNet/IP target area address that is out of range. An attempt was made to write to an EtherNet/IP target input area when the specified size of write data was not received.

6-2 Sending Explicit Messages

6-2-1 Overview

An NE1A-series Controller can send explicit messages from a user program. This function can be used only with DeviceNet.

User-registered messages are sent over the network when user-specified trigger conditions are met. This can be used to notify monitoring and control devices or as a method for specifying outputs to display devices.

When sending an explicit message, set the send conditions in the Logic Editor.

With an NE1A-series Controller, up to 32 bytes of explicit message data can be sent, as shown below.

Explicit Message Data Format

Parameter name	Data size
Destination node address	1 byte
Service code	1 byte
Class ID	2 bytes
Instance ID	2 bytes
Service data	0 to 26 bytes

For information on service codes, class IDs, instance IDs, and service data, refer to the manual for the destination device of the message.

6-2-2 Procedure

Set the conditions using the following procedure.

1. **Trigger Address Setting**
Set the condition for sending the explicit message. The explicit message will be sent when the set address turns ON.
2. **Send Condition Setting**
Set the send conditions for the explicit message. The number of retries can also be set.
3. **Creating a Send Message**
Check the object specifications at the destination node and create a send message based on the explicit message format.

6-2-3 Restrictions

- One address can be set in the user program for the trigger address.
- The NE1A-series Controller's internal I/O memory is sent as a response to an explicit message. Explicit messages can be sent from a user program in the Controller, but internal information in the Controller cannot be used as send message data.
- Response data to explicit messages cannot be used in an NE1A-series Controller's user programs.
- Sending an explicit message command is possibly to the nodes on the same DeviceNet network.

⚠ WARNING

Serious injury may possibly occur due to loss of required safety functions. Do not use explicit message data as safety data.

The necessary measures for safety communications are not taken for explicit message communications.

**Note**

- Refer to DeviceNet specifications for details on explicit message parameters.
- Contact the ODVA to obtain copies of the DeviceNet specification. ODVA's URL: <http://www.odva.org/>

SECTION 7 I/O Control

7-1	Common Functions	128
7-1-1	I/O Comment Function	128
7-1-2	I/O Power Monitor	129
7-1-3	Contact Operation Counter Unit Ver. 1.0 or Later	129
7-1-4	Total ON Time Monitor Function Unit Ver. 1.0 or Later	131
7-2	Safety Inputs	135
7-2-1	Overview.	135
7-2-2	Input Channel Mode Setting	136
7-2-3	Test Source Setting	136
7-2-4	Input ON/OFF Delays.	136
7-2-5	Dual Channel Mode Setting	137
7-2-6	Error Handling	139
7-3	Test Outputs	140
7-3-1	Test Output Mode Setting	140
7-3-2	Error Handling	140
7-4	Safety Outputs.	141
7-4-1	Overview.	141
7-4-2	Output Channel Mode Setting	141
7-4-3	Dual Channel Mode Setting	141
7-4-4	Error Handling	142

7-1 Common Functions

7-1-1 I/O Comment Function

An optional name consisting of up to 32 characters can be registered in the NE1A-series Controller for each I/O terminal using the Network Configurator. These I/O comments can be used in the Function List of the Logic Editor as I/O tags, enabling easy conceptualization of what is actually being controlled and simplifying programming.

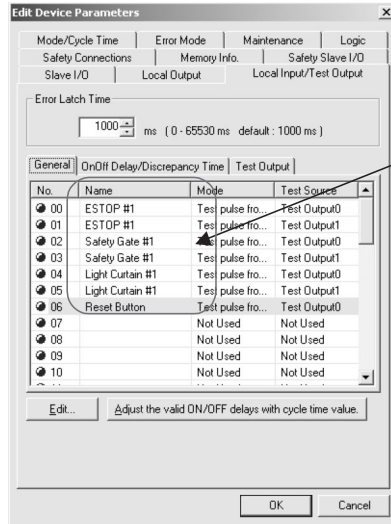

Set the I/O comments.

The set comments are registered as I/O tags in the Function List of the Logic Editor.

Programming is possible using I/O tags.

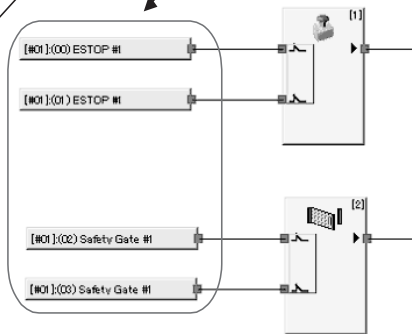
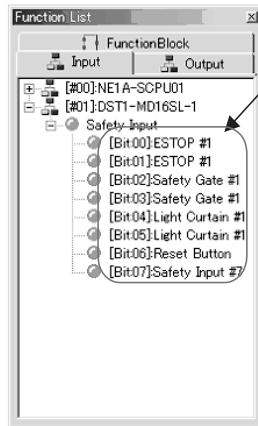

7-1-2 I/O Power Monitor

The I/O power supply input can be monitored to confirm if it is normal. If an I/O terminal on the NE1A-series Controller is set to any setting other than *Not Used* and the normal power supply voltage is not input, the following items will be displayed on the 7-segment display:

- Power supply for input not input normally: P4
- Power supply for output not input normally: P5

I/O power supply status can also be monitored in the General Status in DeviceNet I/O communications.

7-1-3 Contact Operation Counter **Unit Ver. 1.0 or Later**

Overview

This function can be used with Controllers with unit version 1.0 or later (including Controllers that support EtherNet/IP). It counts the number of OFF → ON operations at a local input, test output, or local output and stores the count internally in non-volatile memory.

- Count range: 0 to 4,294,967,295 operations (stored as 00000000 to FFFFFFFF Hex)
- Count units: Operations
- Resolution: Depends on the cycle time.

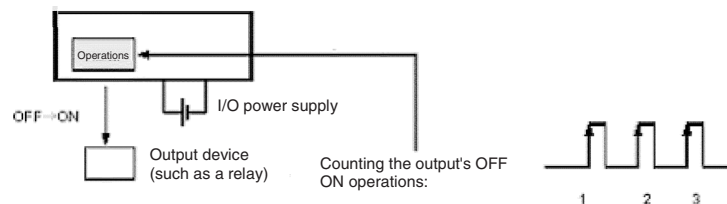

This information can be monitored using the Network Configurator or explicit messaging.

- Note**
- (1) The Contact Operation Counter function (Count) and Total ON Time Monitor function (Time) cannot be used simultaneously on one bit. Select one of these functions with the Maintenance Counter Mode Choice setting.
 - (2) When the Maintenance Counter Mode Choice setting is changed, the collected data (operations count or total ON time) will be cleared.
 - (3) These functions do not operate when the I/O power supply is OFF.

Setting the Contact Operations Alarm Threshold with the Network Configurator

The maintenance mode (Maintenance Counter Mode Choice) and alarm threshold (Threshold Maintenance Counter) can be set for each local input, test output, and local output terminal.

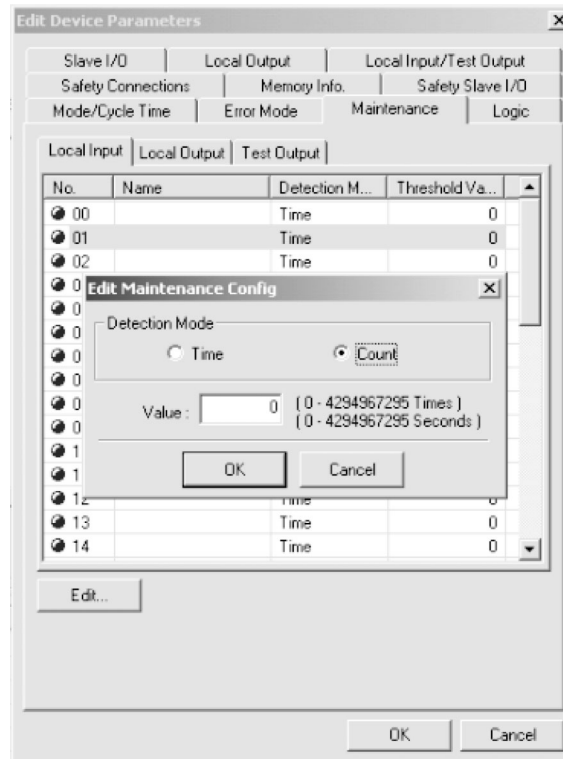

If the alarm threshold (Threshold Maintenance Counter) is set to 0, the Controller will not compare the count or time PV to the alarm threshold SV.

Monitoring Operations from the Network Configurator

Any of the following methods can be used to monitor the number of contact operations in the local input status, test output status, or local output status.

1. Select the device and select **Device – Maintenance information** from the menu bar.
2. Select the device and click the toolbar's **Maintenance** Button.
3. Select the device, right-click that device, and select **Maintenance information** from the popup menu.
4. Select the device, select **Device – Monitor** from the menu bar, and click the **Maintenance** Tab in the displayed window.
5. Select the device, click the toolbar's **Device Monitor** Button, and click the **Maintenance** Tab in the displayed window.
6. Select the device, right-click that device, select **Monitor** from the popup menu, and click the **Maintenance** Tab in the displayed window.

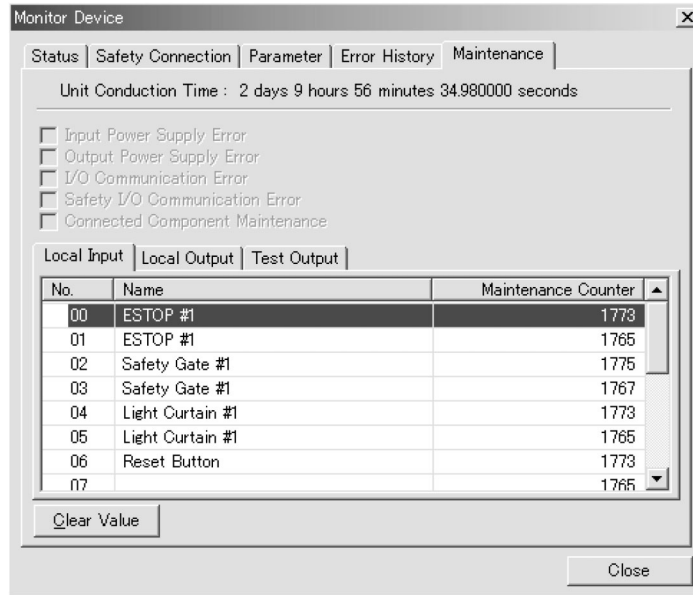

Each I/O point's accumulated contact operations count can be cleared. To clear the count, select the contact operations count to be cleared and click the **Clear Value** Button.

7-1-4 Total ON Time Monitor Function **Unit Ver. 1.0 or Later**

Overview

This function can be used with Controllers with unit version 1.0 or later (including Controllers that support EtherNet/IP). It times how long a local input, test output, or local output is ON and stores that total ON time internally in non-volatile memory.

- Count time: 0 to 4,294,967,295 s (stored as 00000000 to FFFFFFFF hex)
- Count units: Seconds

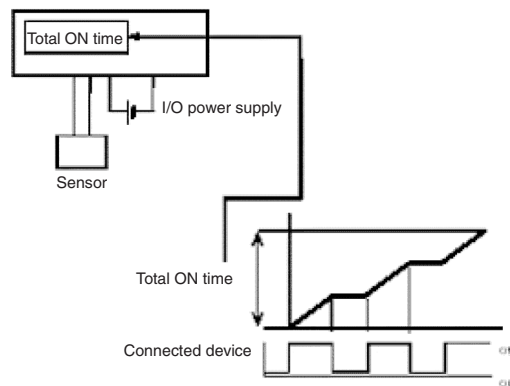

This information can be monitored using the Network Configurator or explicit messaging.

- Note**
- (1) The Total ON Time Monitor function (Time) and Contact Operation Counter function (Count) cannot be used simultaneously on one bit. Select one of these functions with the Maintenance Counter Mode Choice setting.
 - (2) When the Maintenance Counter Mode Choice setting is changed, the collected data (operations count or total ON time) will be cleared.
 - (3) These functions do not operate when the I/O power supply is OFF.
 - (4) The Total ON Time Monitor function checks whether the connected device is ON at about 1-s intervals. This function may not count the total ON time precisely if the device is ON for intervals of less than 1 second.

■ **Calculating the Total ON Time with 0.5-s ON Pulses**

In figure A, the bit is actually ON for $0.5\text{ s} \times 3 = 1.5\text{ s}$, but the bit is ON just once when the status is checked, so the total ON time is measured as 1 s.

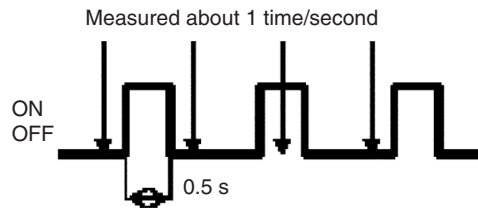

Figure A

In figure B, the bit is actually ON for $0.5\text{ s} \times 3 = 1.5\text{ s}$, but the bit is ON twice when the status is checked, so the total ON time is measured as 2 s.

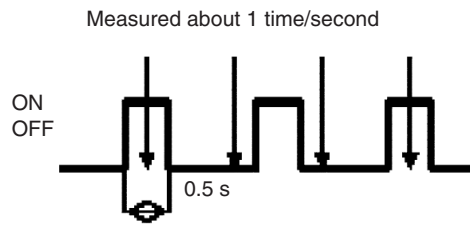

Figure B

■ **Calculating the Total ON Time with 1.5-s ON Pulses**

In figure C, the bit is actually ON for $1.5\text{ s} \times 2 = 3\text{ s}$, but the bit is ON four times when the status is checked, so the total ON time is measured as 4 s.

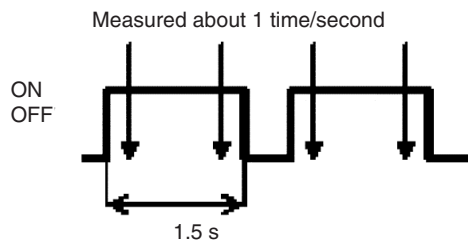
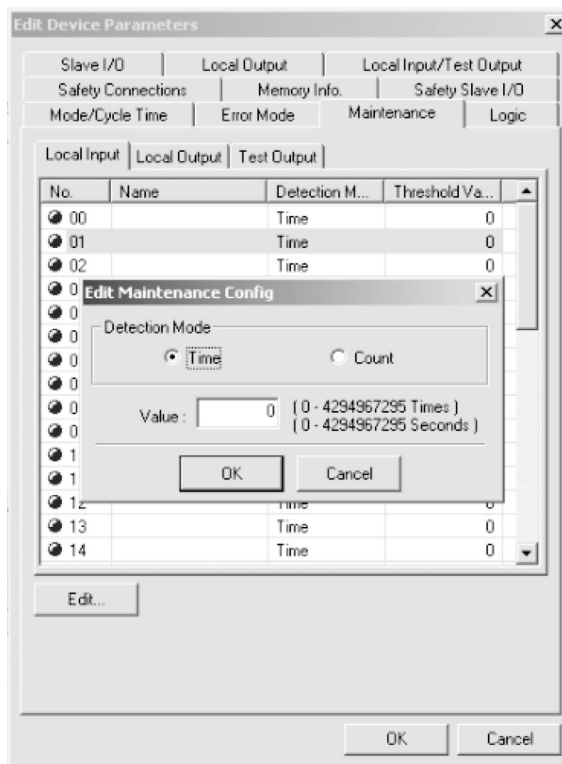

Figure C

Setting the Total ON Time Alarm Threshold with the Network Configurator

The maintenance mode (Maintenance Counter Mode Choice) and alarm threshold (Threshold Maintenance Counter) can be set for each local input, test output, and local output terminal.



If the alarm threshold (Threshold Maintenance Counter) is set to 0, the Controller will not compare the count or time PV to the alarm threshold SV.

Monitoring the Total ON Time from the Network Configurator

Any of the following methods can be used to monitor the total ON time in the local input status, test output status, or local output status.

1. Select the device and select **Device – Maintenance information** from the menu bar.
2. Select the device and click the toolbar's **Maintenance** Button.
3. Select the device, right-click that device, and select **Maintenance information** from the popup menu.
4. Select the device, select **Device – Monitor** from the menu bar, and click the **Maintenance** Tab in the displayed window.
5. Select the device, click the toolbar's **Device Monitor** Button, and click the **Maintenance** Tab in the displayed window.
6. Select the device, right-click that device, select **Monitor** from the popup menu, and click the **Maintenance** Tab in the displayed window.

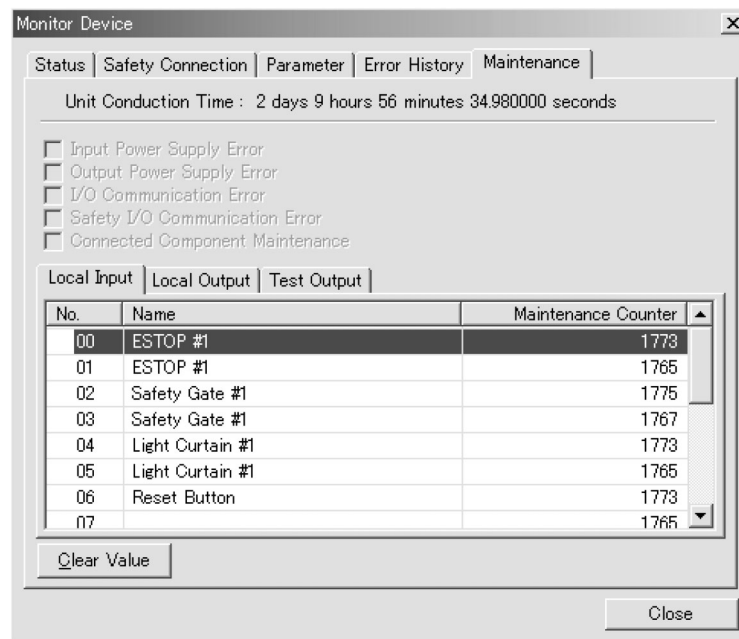

Each I/O point's accumulated total ON time can be cleared. To clear the time, select the total ON time to be cleared and click the **Clear Value** Button.

7-2 Safety Inputs

7-2-1 Overview

The NE1A-SCPU01(-V1) or NE1A-SCPU01-EIP is equipped with 16 safety input terminals.

The NE1A-SCPU02 or NE1A-SCPU02-EIP is equipped with 40 safety input terminals.

By selecting the setup and wiring based on the types of input devices to be connected or the safety level to be achieved, the NE1A-series Controller can flexibly handle various applications. For example, an NE1A-series Controller's safety inputs can be used as described below.

Connecting to Contact Output Safety Devices

The NE1A-series Controller's test output signal (a pulse output) is input by connecting to a contact output device. Input signal line errors can then be detected by inputting the test output signal.

- Short circuits to the power supply line (positive side)
- Earth faults
- Short circuits between input signals

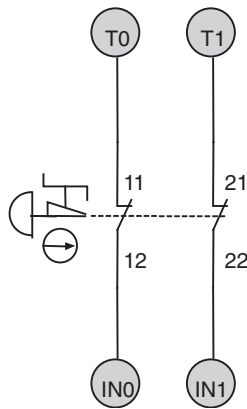

Connecting Semiconductor Output Safety Devices

The output from a 24-VDC semiconductor, such as the OSSD output from a Light Curtain, is input. Errors in the OSSD output signal line (i.e., the NE1A-series Controller's input signal line) is detected at the external connection device.

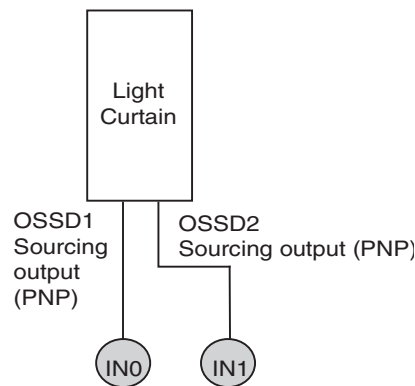

7-2-2 Input Channel Mode Setting

The input channel mode of local safety inputs is set based on the type of external device to be connected.

Channel Mode	Description
Not used	Input not connected to an external device.
Test pulse from test output	Connects a contact output safety device with a test output. When this mode is selected, select the test output terminal to use as the test source and set the test output mode to <i>Pulse Test Output</i> . This enables detection of short circuits with the power supply line (positive side), earth faults, and short circuits with other input signal lines.
Used as safety input	Used when connecting to safety devices with a semiconductor output, such as a Light Curtain.
Used as standard input	Input connected to a standard (non-safety) device.

7-2-3 Test Source Setting

Select the test output terminal to use as the test source for the safety input when the input channel mode is set to *Test pulse from test output*. If short circuit detection between input wiring lines is necessary, specify a different test output terminal.

Examples:

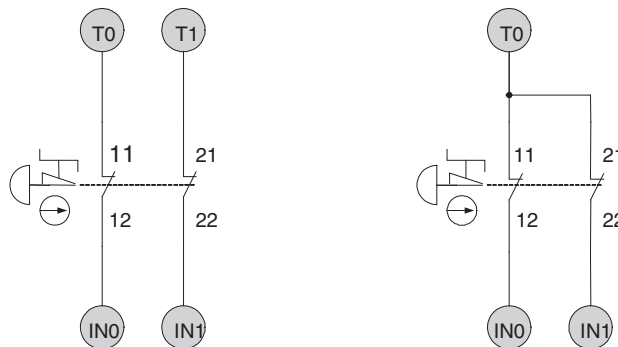

Circuit in Which Short Circuit Detection between Input Signals Is Required.

Circuit in Which Short Circuit Detection between Input Signals Is Not Required.

Note With the NE1A-SCPU02 or NE1A-SCPU02-EIP, terminals T0 to T3 can be selected as the test sources for IN0 to IN19. Terminals T4 to T7 can be selected as the test sources for IN20 to IN39.

7-2-4 Input ON/OFF Delays

For the NE1A-series Controller’s local safety inputs, input ON/OFF delays can be set in increments of multiples of the Controller’s cycle time between 0 and 126 ms. Setting a larger value helps to reduce influence from external device chattering.

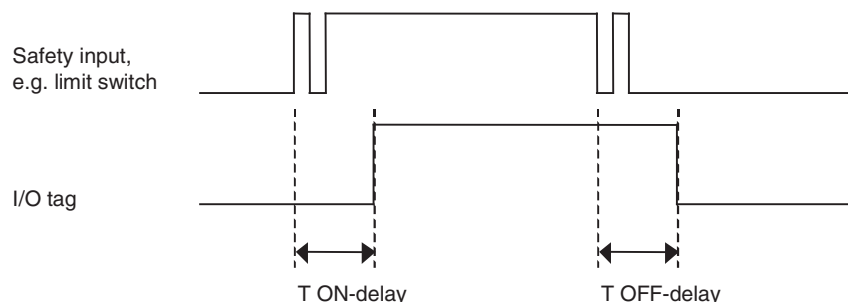

IMPORTANT Both input ON delays and OFF delays must be added to the I/O response performance. This will affect the safety distance calculation. For further details, refer to *SECTION 11 Remote I/O Communications Performance and Local I/O Response Time*.

7-2-5 Dual Channel Mode Setting

An NE1A-series Controller's local safety input terminals can be set to Dual Channel Mode. Setting Dual Channel Mode enables the following.

- The status of the two inputs can be evaluated and reflected in I/O tags.
- The discrepancy time between changes in the status of the two inputs can be evaluated.

Channel mode	Description
Single Channel	Used as an independent safety input terminal.
Dual Channel Equivalent	Used as a Dual Channel Equivalent Input with the paired safety input.
Dual Channel Complementary	Used as a Dual Channel Complementary Input with the paired safety input.

Reflecting Input Status in Input I/O Tags

The status input to the safety input terminals is reflected in the I/O tags according to the channel mode as shown in the following tables.

Channel mode	Input to safety input terminal	Input Tag	Meaning of status
	IN (x)	IN (x)	
Single Channel	0	0	Inactive (OFF)
	1	1	Active (ON)

X = 0 to 15 (NE1A-SCPU01(-V1) or NE1A-SCPU01-EIP)
 X = 0 to 39 (NE1A-SCPU02 or NE1A-SCPU02-EIP)

Channel Mode	Input to safety input terminal		Input Tag		Meaning of status
	IN (n)	IN (n+1)	IN (n)	IN (n+1)	
Dual Channel Equivalent	0	0	0	0	Inactive (OFF)
	0	1	0	0	Discrepant
	1	0	0	0	Discrepant
	1	1	1	1	Active (ON)
Dual Channel Complementary	0	0	0	1	Discrepant
	0	1	0	1	Inactive (OFF)
	1	0	1	0	Active (ON)
	1	1	0	1	Discrepant

n = Even number

Input Discrepancy Time Evaluation

For two inputs set in Dual Channel Mode, the time is monitored from a change in the value of one input to a change in the value of the other input (discrepancy time). When the value of the other input does not change within the set discrepancy, it is regarded as an error. The set discrepancy time can be set in increments of 10 ms between 0 (invalid) and 65,530 ms.

The discrepancy time cannot be set in Single Channel Mode.

Normal Operation for Dual Channel Equivalent Inputs

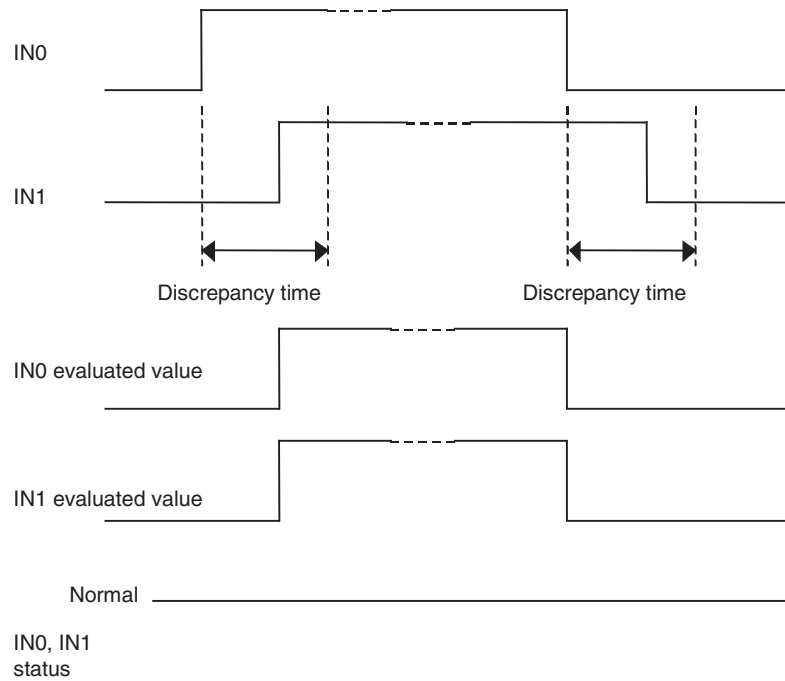

Error Operation for Dual Channel Equivalent Inputs (Discrepancy error)

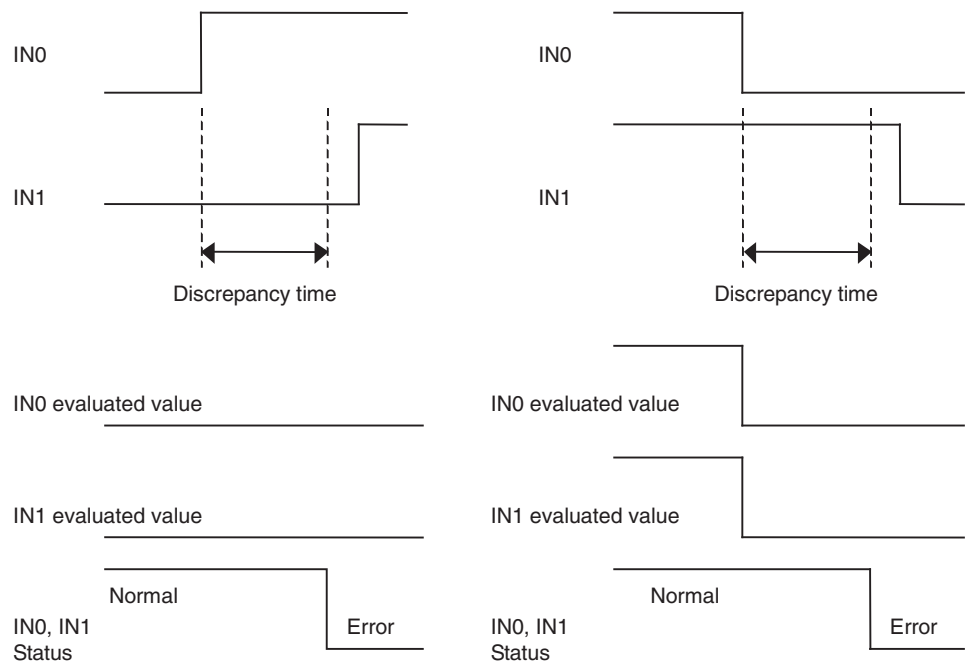

Note The NE1A-series Controllers supports function blocks with functionality equivalent to Dual Channel Mode. If Dual Channel Mode is set in a function block, then the safety input terminal can be set to Single Channel Mode.

7-2-6 Error Handling

Behavior on Error Detection

Behavior in Single Channel Mode

The following operations are performed if an error is detected during self-diagnosis.

- I/O tags corresponding to safety input terminals for which errors have been detected are made inactive.
- The LED indicator of the safety input terminal with the error lights red.
- The error appears in the error history.
- The NE1A-series Controller continues to operate.

Behavior in Dual Channel Mode

The following operations are performed if a discrepancy error is detected.

- I/O tags corresponding to safety input terminal pairs for which errors have been detected are made inactive.
- Both LED indicators of the safety input terminals with the error light red.
- The errors appear in the error history.
- The NE1A-series Controller continues to operate.

The following operations are performed if an error is detected in one of the two inputs.

- I/O tags corresponding to safety input terminal pairs for which errors have been detected are made inactive.
- The LED indicator of the safety input with the error lights red, and the LED indicator of the other input flashes red.
- The errors appear in the error history.
- The NE1A-series Controller continues to operate.

Error Latch Time Setting

The time to latch the error state when an error occurs in a safety input circuit can be set. The error state will continue until the error latch time passes even if the cause of the error is momentarily removed. When monitoring errors from a monitoring system, take the monitoring interval into account when setting the error latch time.

The error latch time can be set in increments of 10 ms between 0 and 65,530 ms. The default is 1,000 ms.

Resetting Errors

All conditions below are necessary to recover from an error that has occurred in a safety input.

- The cause of the error must be removed.
- The error latch time must have passed.
- The input signal must return to an inactive state and there must be no error condition detected. (e.g., by pressing the emergency stop button or opening a door).

7-3 Test Outputs

7-3-1 Test Output Mode Setting

The NE1A-SCPU01(-V1) or NE1A-SCPU01-EIP is equipped with four test output terminals.

The NE1A-SCPU02 or NE1A-SCPU02-EIP is equipped with eight test output terminals.

The following settings are supported for the test outputs.

Channel mode	Description
Not used	The corresponding test output terminal is not used.
Standard output	Connected to the input for indicator light or a PLC. Used as a monitor output.
Pulse test output	Connected in combination with a safety input terminal and contact output device. The test output terminal outputs a pulse for circuit diagnosis. Pulses are output to each test output terminal at a different time.
Muting lamp output	Can be set as the output for a muting lamp. When the output is ON, disconnection of the muting lamp can be detected. With the NE1A-SCPU01(-V1) or NE1A-SCPU01-EIP, only the T3 terminal can be set to this mode. With the NE1A-SCPU02 or NE1A-SCPU02-EIP, the T3 or T7 terminal can be set to this mode.

7-3-2 Error Handling

Behavior on Error Detection

The following operations are performed if an error is detected during self-diagnosis:

- The output terminals for which errors have been detected will be made inactive without intervention from the user program.
- The error will be recorded in the error history.
- The NE1A-series Controller will continue to operate.

Error Latch Time Setting

The time to latch the error state when an error occurs in a safety input terminal or test output terminal can be set. The error state will continue until the error latch time passes even if the cause of the error is momentarily removed. When monitoring errors from a monitoring system, take the monitoring interval into account when setting the error latch time. The error latch time can be set in increments of 10 ms between 0 and 65,530 ms. The default is 1,000 ms.

Resetting Errors

Errors detected at test output terminals will be automatically reset after the error latch time. Leaving the short-circuit state as is may result in failure due to increased temperatures. If an external load short circuit occurs, remove the cause immediately.

7-4 Safety Outputs

7-4-1 Overview

NE1A-series Controllers are equipped with eight safety output terminals.

By selecting the setup and wiring based on the types of external devices to be connected or the safety level to be achieved, the NE1A-series Controller can flexibly handle various applications.

The following output signal line errors can be detected for the NE1A-series Controllers.

- Contact with the power supply line (positive side, only when the output is OFF)
- Ground faults

If the diagnostic pulse output is enabled, the following errors can be detected.

- Contact with the power supply line (positive side, when the output is ON or OFF)
- Ground faults
- Short circuits between output lines

7-4-2 Output Channel Mode Setting

Set the output channel mode based on the type of external device to be connected.

Channel mode	Description
Not Used	Output not connect to an output device.
Safety	A test pulse is not output when the output is ON. Short circuits with the power supply line (when the output is OFF) and ground faults can be detected.
Safety Pulse Test	A test pulse is output when the output is ON. This enables detecting short circuits with the power supply line (positive side) (when the output is ON or OFF), ground faults, and short circuits between output signals.

IMPORTANT If a safety pulse output is set, an OFF pulse signal (pulse width: 580 μ s) will be output to diagnose the output circuit when the safety output turns ON. Check the input response time of the control device connected to the NE1A-series Controller to be sure that this output pulse will not cause malfunctions.

7-4-3 Dual Channel Mode Setting

The NE1A-series Controller's Local safety output terminals can be set to Dual Channel Mode. Setting Dual Channel Mode enables the following.

- An error will be detected if the two outputs from a user program are not equivalent.
- If an error is detected in one of the two output circuits, both outputs to the external device will become inactive.

Channel mode	Description
Single Channel	Used as an independent safety output.
Dual Channel	Used as a Dual Channel Output with the paired safety output terminal. The output can be turned on when both the output and the paired safety output are normal.

Reflecting Output Data from Output I/O Tags to Safety Output Terminals

Output I/O tag data is reflected in the safety output terminals according to the channel mode, as shown in the following tables.

Channel Mode	Output tag		Safety output terminal	The meaning of status
	OUT (x)		OUT (x)	
Single Channel	0		0	Inactive (OFF)
	1		1	Active (ON)

X = 0-7

Channel Mode	Output tag		Safety output terminal		The meaning of status
	IN (n)	IN (n+1)	OUT (n)	OUT (n+1)	
Dual Channel	0	0	0 (OFF)	0 (OFF)	Inactive (OFF)
	0	1	0 (OFF)	0 (OFF)	Violation at Safety Output (OFF)
	1	0	0 (OFF)	0 (OFF)	Violation at Safety Output (OFF)
	1	1	1 (ON)	1 (ON)	Active (ON)

n = even numbers

7-4-4 Error Handling

Behavior on Error Detection

Behavior in Single Channel Mode

The following operations are performed if an error is detected during self-diagnosis.

- The safety output which the error was detected becomes inactive without depending on the user program.
- The LED indicator of the safety output terminal with the error lights red.
- The error appears in the error history.
- The NE1A-series Controller continues to operate.

Behavior in Dual Channel Mode

The following operations are performed if an error is detected in one of the two outputs.

- Both outputs to the external device become inactive without depending on a user program.
- The LED indicator of the safety output terminal with the error lights red, and LED indicator of the other output flashes red.
- The error appears in the error history.
- The NE1A-series Controller continues to operate.

The following operations are performed if the two outputs from the user program to output I/O tags are equivalent.

- Both outputs to the external device become inactive without depending on a user program.
- The LED indicators of the paired safety output terminals light red.
- The error appears in the error history.
- The NE1A-series Controller continues to operate.

Error Latch Time Setting

The time to latch the error state when an error occurs in a safety output circuit can be set. The error state will continue until the error latch time passes even if the cause of the error is momentarily removed. When monitoring errors from a monitoring system, take the monitoring interval into account when setting the error latch time.

The error latch time can be set in increments of 10 ms between 0 and 65,530 ms. The default is 1,000 ms.

Resetting Errors

All conditions below are necessary to recover from an error that has occurred in a safety output.

- The cause of the error must be removed.
- Error latch time must have passed.
- The output signals to the output I/O tags from the user application that correspond to the safety output terminals must go inactive.

Note If the Dual Channel Mode is set for two outputs to implement redundant circuits and an error is detected for one of the outputs, the other output can be made to go inactive without relying on the user program. If the redundant circuits are implemented using two outputs in Single Channel Mode, the user program must be used to detect the error (using the External Device Monitoring function block).

SECTION 8

Programming

8-1	Outline of Programming	146
8-1-1	Outline	146
8-1-2	Programming Basics	146
8-1-3	Program Capacity	148
8-2	Function Block Overview	149
8-2-1	Supported Function Blocks	149
8-3	Function Block Editing	150
8-3-1	Function Block Parameter Settings	150
8-3-2	I/O Settings	153
8-4	Command Reference: Logic Functions	155
8-4-1	NOT	155
8-4-2	AND	155
8-4-3	OR	158
8-4-4	Exclusive OR (EXOR)	160
8-4-5	Exclusive NOR (EXNOR)	161
8-4-6	Reset Set Flip-Flop (RS-FF) Unit Ver. 1.0 or Later	161
8-4-7	Comparator Unit Ver. 1.0 or Later	163
8-5	Command Reference: Function Blocks	166
8-5-1	Reset	166
8-5-2	Restart	169
8-5-3	Emergency Stop Pushbutton Monitoring (E-Stop)	171
8-5-4	Light Curtain Monitoring	174
8-5-5	Safety Gate Monitoring	176
8-5-6	Two-hand Control	181
8-5-7	OFF-delay Timer	184
8-5-8	ON-delay Timer	185
8-5-9	User Mode Switch	186
8-5-10	External Device Monitoring (EDM)	188
8-5-11	Routing	189
8-5-12	Muting Unit Ver. 1.0 or Later	190
8-5-13	Enable Switch Monitoring (Enable Switch) Unit Ver. 1.0 or Later	206
8-5-14	Pulse Generator Unit Ver. 1.0 or Later	208
8-5-15	Counter Unit Ver. 1.0 or Later	210
8-5-16	Multi Connector Unit Ver. 1.0 or Later	212

8-1 Outline of Programming

8-1-1 Outline

The NE1A-series Safety Network Controller is programmed by starting a Logic Editor from the Network Configurator. As shown below, the Logic Editor consists of a Function List where function blocks, I/O tags, and other programming elements are registered and a workspace where programming is actually performed.

Programming is achieved using the function blocks, I/O tags, and other programming elements are registered in the function list.

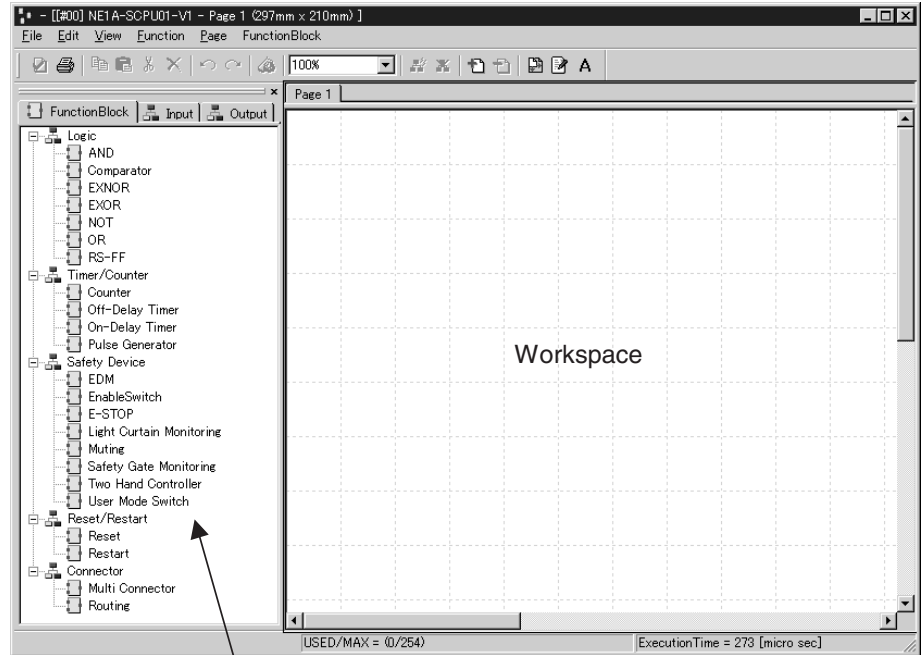

Function List

8-1-2 Programming Basics

Programs are created from logic functions and function blocks, which indicate commands, input tags, which indicate data input sources, and output tags, which indicate data output destinations. The I/O are connected with connection lines.

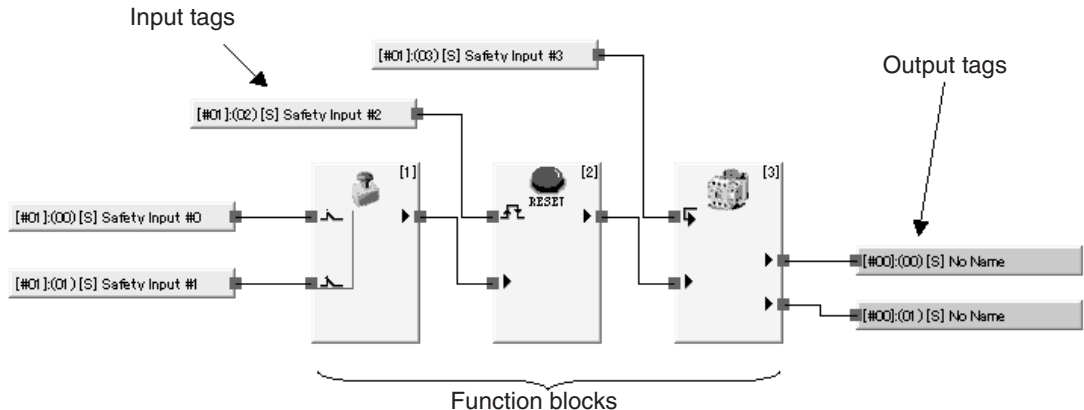

■ Input Tags

Input tags reflect the status of inputs in the following I/O areas.

- Input area from the NE1A-series Controller's local terminals
- Input area from safety slaves registered as communications partners
- I/O area reflected from Safety Master data
- I/O area reflected from Standard Master data
- Local input status **Unit Ver. 1.0 or Later**
- Local output status **Unit Ver. 1.0 or Later**
- Test output status **Unit Ver. 1.0 or Later**
- Muting lamp status **Unit Ver. 1.0 or Later**
- General Unit status **Unit Ver. 1.0 or Later**
- I/O area reflecting data from EtherNet/IP Standard Originators (Only Controllers that Support EtherNet/IP)

Note Controllers that support EtherNet/IP are included among Controllers with unit version 1.0 or later.

Input tags used in the Logic Editor include the following information.

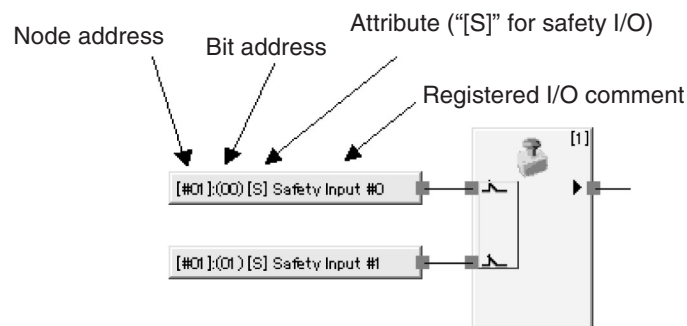

■ Output Tags

Output tags reflect the status of inputs in the following I/O areas.

- Output area from the NE1A-series Controller's local terminals
- Output area from safety slaves registered as communications partners
- I/O area reflected from Safety Master data
- I/O area reflected from Standard Master data
- Special area for restarting safety I/O communications
Unit Ver. 1.0 or Later
- I/O area reflecting data to EtherNet/IP Standard Originators (Only Controllers that Support EtherNet/IP)

Note Controllers that support EtherNet/IP are included among Controllers with unit version 1.0 or later.

Output tags used in the Logic Editor include the following information.

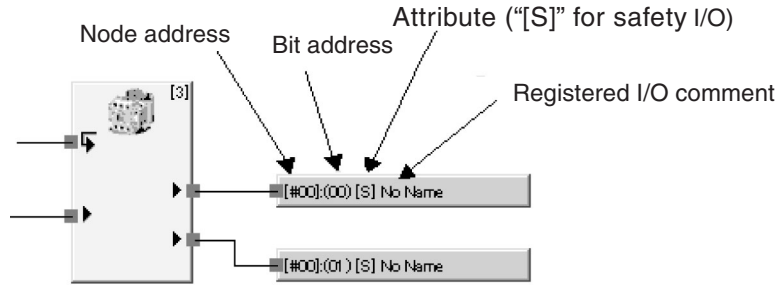

WARNING	
Serious injury may possibly occur due to loss of required safety functions. Always verify that the safety-related signals used in safety-related logic meet applicable standards and regulations. Input only safety input signals to function blocks. It is the user's responsibility to verify that the proper sources for signals used in conjunction with these function blocks and the overall safety logic implementation adhere to relevant safety standards and regulations.	
Serious injury may possibly occur due to loss of required safety functions. When implementing safety-related functions, you must verify that the control strategy and risk reduction techniques you are using adhere to local, regional, and national regulations. Consult these regulations and industry standards to determine the requirements that may apply to your application.	

8-1-3 Program Capacity

The following table shows the maximum size of user program that can be used in the NE1A-series Controllers.

Model	Total number of logic functions and function blocks
Pre-Ver. 1.0 Controllers	128
Controllers with unit version 1.0 or later (including Controllers that support Ether-Net/IP)	254

8-2 Function Block Overview

User programming for the NE1A-series Controller is accomplished using function blocks. Various safety applications can be achieved by using the function blocks described in this section to program operation to be compliant with safety standards.

8-2-1 Supported Function Blocks

The following tables show which logic functions and function blocks are supported in each NE1A-series Controller.

Logic Functions

Name	Notation in function list	Compatible unit versions
NOT	NOT	All
AND	AND	All
OR	OR	All
Exclusive OR	EXOR	All
Exclusive NOR	EXNOR	All
Reset Set Flip-flop	RS-FF	Unit version 1.0 or later (including Controllers that support EtherNet/IP)
Comparator	Comparator	

Function Blocks

Name	Notation in function list	Compatible unit versions
Reset	Reset	All
Restart	Restart	All
Emergency Stop Pushbutton Monitoring	E-STOP	All
Light Curtain Monitoring	Light Curtain Monitoring	All
Safety Gate Monitoring	Safety Gate Monitoring	All
Two-hand Controller	Two Hand Controller	All
OFF-Delay Timer	Off-Delay Timer	All
ON-Delay Timer	On-Delay Timer	All
User Mode Switch	User Mode Switch	All
External Device Monitoring	EDM	All
Routing	Routing	All
Muting	Muting	Unit version 1.0 or later (including Controllers that support EtherNet/IP)
Enable Switch	Enable Switch	
Pulse Generator	Pulse Generator	
Counter	Counter	
Multi Connector	Multi Connector	

8-3 Function Block Editing

Editing of function blocks can be used to set parameters, add optional I/O, and add comments according to the application.

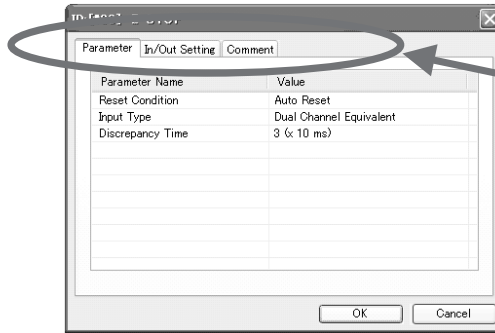

Tabs:
Function block parameters
Out point Setting, In/Out
Settings Comments

8-3-1 Function Block Parameter Settings

The following parameters can be set for function blocks depending on the user application. The parameters that can be set will vary from function block to function block.

- Input type
- Discrepancy time
- Synchronization time
- Function test

Input Type Settings

- Single Channel
- Dual Channel Equivalent
- Dual Channel Complementary
- Dual Channel Equivalent (2 Pairs)
- Dual Channel Complementary (2 Pairs)

The following truth tables outline the internal evaluations performed by the NE1A-series Controller for each type of input signal. In the tables, 0 indicates OFF and 1 indicates ON.

Setting: Single Channel

Input 1 (NC)	Output Enable
0	0
1	1

Setting: Dual Channel Equivalent

Input 1 (NC)	Input 2 (NC)	Output Enable
0	0	0
0	1	0
1	0	0
1	1	1

Setting: Dual Channel Complementary

Input 1 (NC)	Input 2 (NO)	Output Enable
0	0	0
0	1	0
1	0	1
1	1	0

Setting: Dual Channel Equivalent (2 Pairs)

Input 1 (NC)	Input 2 (NC)	Input 3 (NC)	Input 4 (NC)	Output Enable
0	0	0	0	0
0	0	0	1	0
0	0	1	0	0
0	0	1	1	0
0	1	0	0	0
0	1	0	1	0
0	1	1	0	0
0	1	1	1	0
1	0	0	0	0
1	0	0	1	0
1	0	1	0	0
1	0	1	1	0
1	1	0	0	0
1	1	0	1	0
1	1	1	0	0
1	1	1	1	1

Setting: Dual Channel Complementary (2 Pairs)

Input 1 (NC)	Input 2 (NO)	Input 3 (NC)	Input 4 (NO)	Output Enable
0	0	0	0	0
0	0	0	1	0
0	0	1	0	0
0	0	1	1	0
0	1	0	0	0
0	1	0	1	0
0	1	1	0	0
0	1	1	1	0
1	0	0	0	0
1	0	0	1	0
1	0	1	0	1
1	0	1	1	0
1	1	0	0	0
1	1	0	1	0
1	1	1	0	0
1	1	1	1	0

Discrepancy Time

If the function block input type is set to Dual Channel Equivalent or Dual Channel Complementary, the discrepancy time (i.e., the time between changes in the inputs) can be evaluated.

The time between when one of the dual-channel inputs changes until the other one changes is monitored. If the second dual-channel input does not change before the discrepancy time expires, an error will occur and the Output Enable output from the function block will not turn ON.

Dual channel mode	Input signals		Input signal status
	Input 1	Input 2	
Dual Channel Equivalent • Input 1: NC • Input 2: NC	0	0	Inactive
	0	1	Discrepant
	1	0	Discrepant
	1	1	Active
Dual Channel Complementary • Input 1: NC • Input 2: NO	0	0	Discrepant
	0	1	Inactive
	1	0	Active
	1	1	Discrepant

The dual channel modes can be used to detect faults in safety devices and safety device wiring monitored by the function block.

The time between changes in the inputs will not be monitored if the discrepancy time is set to 0.

The discrepancy time is evaluated both when the input signals go from active to inactive and from inactive to active.

■ **Normal Operation Example for Dual Channel Equivalent Setting**

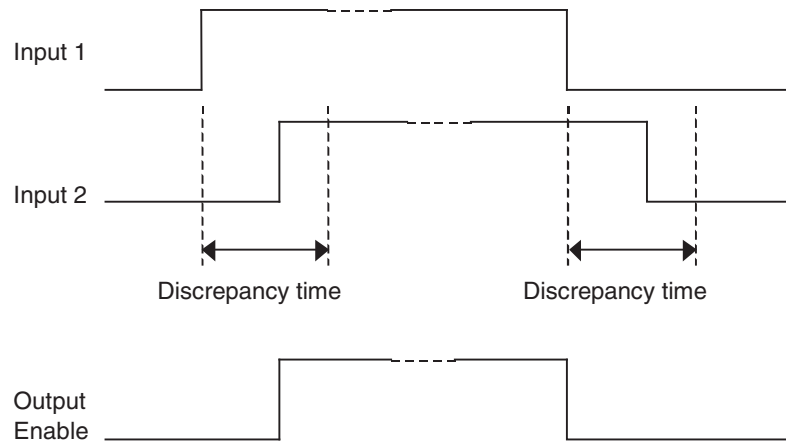

Discrepancy Normal
 Error _____

■ Discrepancy Error Operation Example for Dual Channel Equivalent Setting

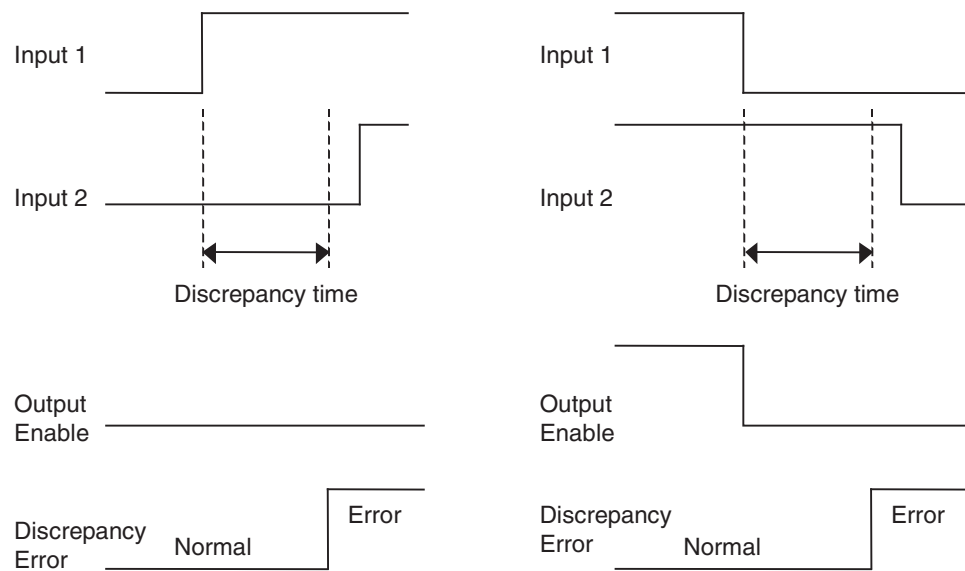

Synchronization Time Setting

If the function block input type is set to Dual Channel Equivalent (2 Pairs) or Dual Channel Complementary (2 Pairs) for the Safety Gate Monitoring function block, the synchronization time (i.e., the time between changes in the input pairs) can be evaluated.

The time between when one of the input pairs changes until the other one changes is monitored. If the second input pair does not change before the synchronization time expires, an error will occur and the Output Enable output from the function block will not turn ON. The time between changes in the input pairs will not be monitored if the synchronization time is set to 0.

Function Tests

Function tests are supported when using the Safety Gate Monitoring function block.

If the function test is enabled when the NE1A-series Controller is started, a safety gate test must be performed when the function test request signal is input from the machine.

8-3-2 I/O Settings

Input and Output Size Settings

The number of inputs and outputs for logic functions can be increased.

Output Points Setting

Optional outputs from function blocks can be enabled.

Fault Present Setting

Fault Present is a diagnostic status bit supported in some function blocks by selecting the checkbox located on the In/Out Setting or Out Point Tab Page of the function block properties. If the *Fault Present* checkbox is selected, an additional Fault Present output will be displayed on the function block.

Example: Safety Gate Monitoring Function Block (SGATE)

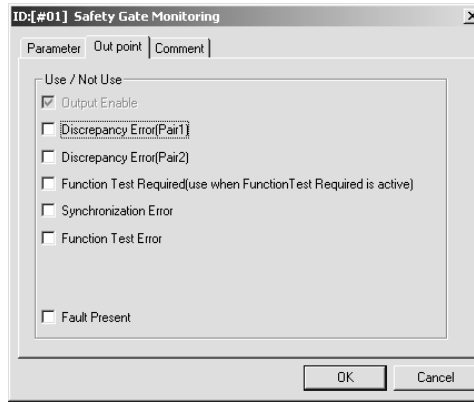

Out Point Tab Page in the Safety Gate Monitoring Function Block Editing Dialog Box

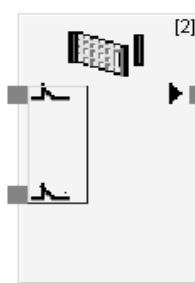

Safety Gate Monitoring Function Block with Default Settings

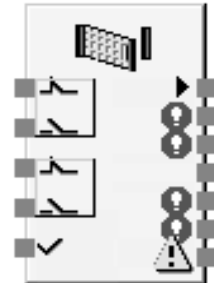

Safety Gate Monitoring Function Block with Maximum Inputs and Outputs Enabled

8-4 Command Reference: Logic Functions

8-4-1 NOT

Diagram

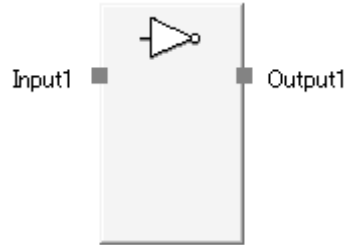

General Description

The output will be the inverse of the input.

Truth Table

Input 1	Output 1
0	1
1	0

0: OFF, 1: ON

8-4-2 AND

Diagram

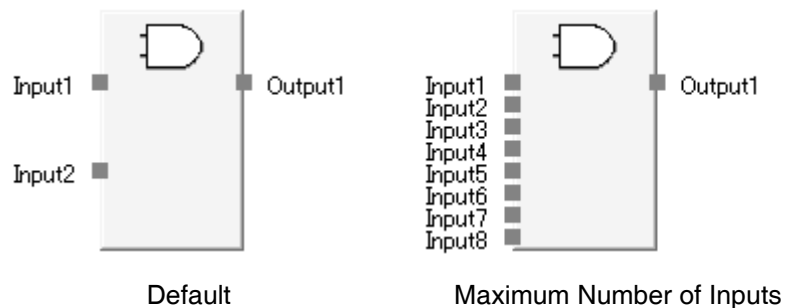

General Description

An AND of the input conditions will be output. Up to eight input conditions can be evaluated.

Optional Input Settings

The number of inputs can be increased on the In/Out Setting Tab Page in the function block property dialog box.

Parameter	Setting range	Default setting
Number of inputs	1 to 8	2

Truth Tables**Truth Table for One-input AND Evaluation**

Input 1	Output 1
0	0
1	1

0: OFF, 1: ON

Truth Table for Two-input AND Evaluation

Input 1	Input 2	Output 1
0	x	0
x	0	0
1	1	1

0: OFF, 1: ON, x: Either ON or OFF

Truth Table for Three-input AND Evaluation

Input 1	Input 2	Input 3	Output 1
0	x	x	0
x	0	x	0
x	x	0	0
1	1	1	1

0: OFF, 1: ON, x: Either ON or OFF

Truth Table for Four-input AND Evaluation

Input 1	Input 2	Input 3	Input 4	Output 1
0	x	x	x	0
x	0	x	x	0
x	x	0	x	0
x	x	x	0	0
1	1	1	1	1

0: OFF, 1: ON, x: Either ON or OFF

Truth Table for Five-input AND Evaluation

Input 1	Input 2	Input 3	Input 4	Input 5	Output 1
0	x	x	x	x	0
x	0	x	x	x	0
x	x	0	x	x	0
x	x	x	0	x	0
x	x	x	x	0	0
1	1	1	1	1	1

0: OFF, 1: ON, x: Either ON or OFF

Truth Table for Six-input AND Evaluation

Input 1	Input 2	Input 3	Input 4	Input 5	Input 6	Output 1
0	x	x	x	x	x	0
x	0	x	x	x	x	0
x	x	0	x	x	x	0
x	x	x	0	x	x	0
x	x	x	x	0	x	0
x	x	x	x	x	0	0
1	1	1	1	1	1	1

0: OFF, 1: ON, x: Either ON or OFF

Truth Table for Seven-input AND Evaluation

Input 1	Input 2	Input 3	Input 4	Input 5	Input 6	Input 7	Output 1
0	x	x	x	x	x	x	0
x	0	x	x	x	x	x	0
x	x	0	x	x	x	x	0
x	x	x	0	x	x	x	0
x	x	x	x	0	x	x	0
x	x	x	x	x	0	x	0
x	x	x	x	x	x	0	0
1	1	1	1	1	1	1	1

0: OFF, 1: ON, x: Either ON or OFF

Truth Table for Eight-input AND Evaluation

Input 1	Input 2	Input 3	Input 4	Input 5	Input 6	Input 7	Input 8	Output 1
0	x	x	x	x	x	x	x	0
x	0	x	x	x	x	x	x	0
x	x	0	x	x	x	x	x	0
x	x	x	0	x	x	x	x	0
x	x	x	x	0	x	x	x	0
x	x	x	x	x	0	x	x	0
x	x	x	x	x	x	0	x	0
x	x	x	x	x	x	x	0	0
1	1	1	1	1	1	1	1	1

0: OFF, 1: ON, x: Either ON or OFF

8-4-3 OR

Diagram

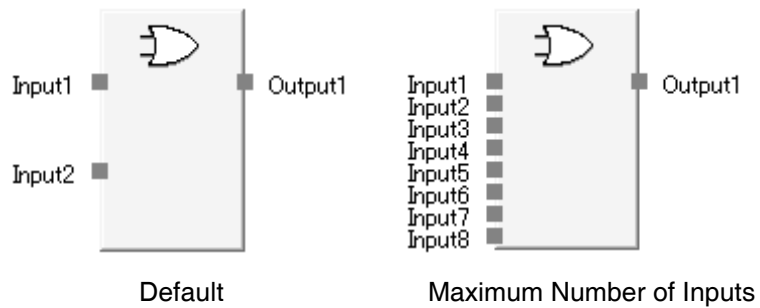

General Description

An OR of the input conditions will be output. Up to eight input conditions can be evaluated.

Optional Input Setting

The number of inputs can be increased on In/Out Setting Tab Page in the function block property dialog box.

Parameter	Setting range	Default setting
Number of inputs	1 to 8	2

Truth Table

Truth Table for One-input OR Evaluation

Input 1	Output 1
0	0
1	1

0: OFF, 1: ON

Truth Table for Two-input OR Evaluation

Input 1	Input 2	Output 1
0	0	0
1	x	1
x	1	1

0: OFF, 1: ON, x: Either ON or OFF

Truth Table for Three-input OR Evaluation

Input 1	Input 2	Input 3	Output 1
0	0	0	0
1	x	x	1
x	1	x	1
x	x	1	1

0: OFF, 1: ON, x: Either ON or OFF

Truth Table for Four-input OR Evaluation

Input 1	Input 2	Input 3	Input 4	Output 1
0	0	0	0	0
1	x	x	x	1
x	1	x	x	1
x	x	1	x	1
x	x	x	1	1

0: OFF, 1: ON, x: Either ON or OFF

Truth Table for Five-input OR Evaluation

Input 1	Input 2	Input 3	Input 4	Input 5	Output 1
0	0	0	0	0	0
1	x	x	x	x	1
x	1	x	x	x	1
x	x	1	x	x	1
x	x	x	1	x	1
x	x	x	x	1	1

0: OFF, 1: ON, x: Either ON or OFF

Truth Table for Six-input OR Evaluation

Input 1	Input 2	Input 3	Input 4	Input 5	Input 6	Output 1
0	0	0	0	0	0	0
1	x	x	x	x	x	1
x	1	x	x	x	x	1
x	x	1	x	x	x	1
x	x	x	1	x	x	1
x	x	x	x	1	x	1
x	x	x	x	x	1	1

0: OFF, 1: ON, x: Either ON or OFF

Truth Table for Seven-input OR Evaluation

Input 1	Input 2	Input 3	Input 4	Input 5	Input 6	Input 7	Output 1
0	0	0	0	0	0	0	0
1	x	x	x	x	x	x	1
x	1	x	x	x	x	x	1
x	x	1	x	x	x	x	1
x	x	x	1	x	x	x	1
x	x	x	x	1	x	x	1
x	x	x	x	x	1	x	1
x	x	x	x	x	x	1	1

0: OFF, 1: ON, x: Either ON or OFF

Truth Table for Eight-input OR Evaluation

Input 1	Input 2	Input 3	Input 4	Input 5	Input 6	Input 7	Input 8	Output 1
0	0	0	0	0	0	0	0	0
1	x	x	x	x	x	x	x	1
x	1	x	x	x	x	x	x	1
x	x	1	x	x	x	x	x	1
x	x	x	1	x	x	x	x	1
x	x	x	x	1	x	x	x	1
x	x	x	x	x	1	x	x	1
x	x	x	x	x	x	1	x	1
x	x	x	x	x	x	x	1	1

0: OFF, 1: ON, x: Either ON or OFF

8-4-4 Exclusive OR (EXOR)

Diagram

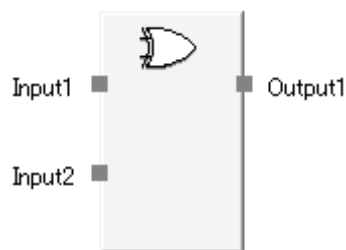

General Description

An exclusive OR of the input conditions will be output.

Truth Table

Truth Table for Exclusive OR Evaluation

Input 1	Input 2	Output 1
0	0	0
0	1	1
1	0	1
1	1	0

0: OFF, 1: ON

8-4-5 Exclusive NOR (EXNOR)

Diagram

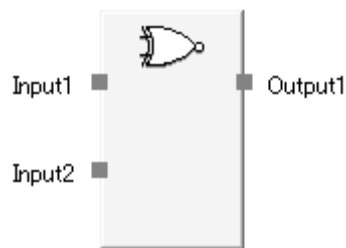

General Description

An exclusive NOR of the input conditions will be output.

Truth Table

Truth Table for Exclusive NOR Evaluation

Input 1	Input 2	Output 1
0	0	1
0	1	0
1	0	0
1	1	1

0: OFF, 1: ON

8-4-6 Reset Set Flip-Flop (RS-FF) Unit Ver. 1.0 or Later

Diagram

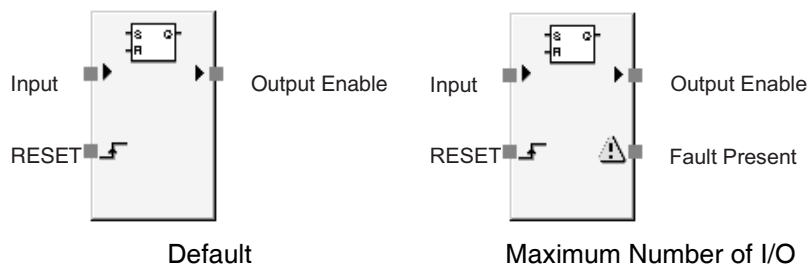

General Description

This function can be used with Controllers with unit version 1.0 or later (including Controllers that support EtherNet/IP).

When the input condition to the Reset Set Flip-Flop function block is turned ON, that ON status is maintained (latched) in the function block and the ON output is maintained at the Output Enable signal.

The ON status is maintained in the function block, so the Output Enable signal stays ON even if the input condition goes from ON to OFF.

The signal maintained in the function block is turned OFF when the function block's RESET condition is turned ON.

Fault Present Output Setting

A Fault Present output can also be used in programming.

To enable this output, select the Fault Present checkbox on the Out Point Tab Page of the function block properties dialog box.

Error Handling and Error Resetting

Error condition	Behavior for error detection		Resetting the error condition
	Output Enable	Fault Present	
Input and Reset are active simultaneously.	OFF (safety state)	ON	Make one of the signals inactive.

Timing Table

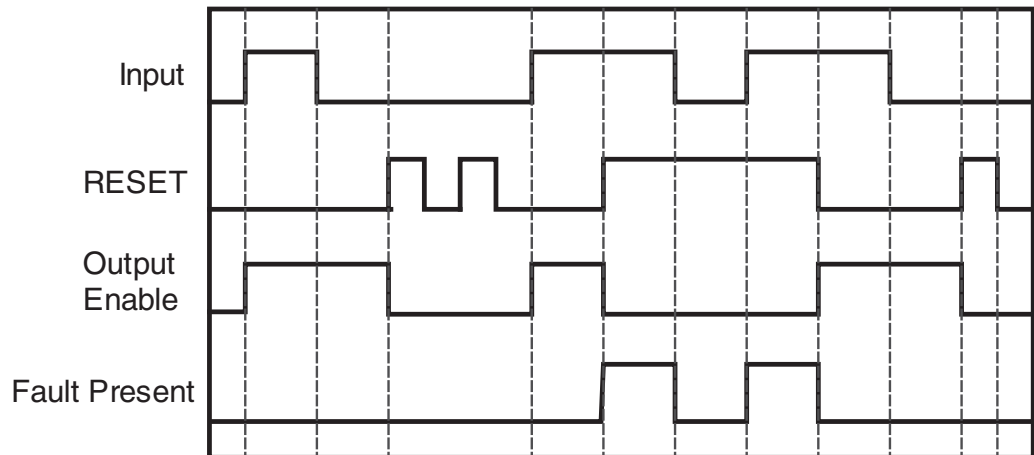

8-4-7 Comparator **Unit Ver. 1.0 or Later**

Diagram

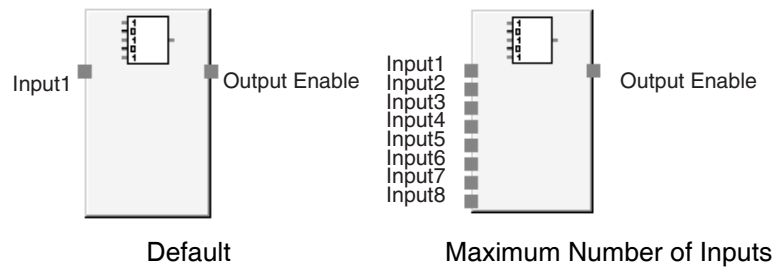

General Description

This function can be used with unit version 1.0 or later (including Controllers that support EtherNet/IP).

The Comparator function block compares the specified input signals (up to 8 inputs) with the comparison data set in the Configurator, and turns ON the Output Enable signal when all of the input signals match the comparison data.

The Output Enable signal will be turned OFF when the input signals no longer match the comparison data.

From 1 to 8 inputs can be set for the input signals.

Set Parameters

Parameter	Setting range	Default setting
Comparison Data	00000000 to 11111111 (Individual bits correspond to Input 1 to Input 8)	00000001 (Input 1 is ON.)

Optional Input Settings

The number of inputs can be increased on the In/Out Setting Tab Page in the function block property dialog box.

Parameter	Setting range	Default setting
Number of inputs	1 to 8	1

Truth Table

■ **Truth Table for Comparator Evaluation (CD = Comparison Data):**

Input signals to Comparator								Output signals from Comparator
Input 1	Input 2	Input 3	Input 4	Input 5	Input 6	Input 7	Input 8	Output Enable
≠ CD for Input 1	x	x	x	x	x	x	x	0
x	≠ CD for Input 2	x	x	x	x	x	x	0
x	x	≠ CD for Input 3	x	x	x	x	x	0
x	x	x	≠ CD for Input 4	x	x	x	x	0
x	x	x	x	≠ CD for Input 5	x	x	x	0
x	x	x	x	x	≠ CD for Input 6	x	x	0
x	x	x	x	x	x	≠ CD for Input 7	x	0
x	x	x	x	x	x	x	≠ CD for Input 8	0
= CD for Input 1	= CD for Input 2	= CD for Input 3	= CD for Input 4	= CD for Input 5	= CD for Input 6	= CD for Input 7	= CD for Input 8	1

0: OFF; 1: ON

Note “= CD for Input n” indicates that the Comparator input signals are the same as the comparison data.
 “≠ CD for Input n” indicates that the Comparator input signals are not the same as the comparison data.
 ”x” indicates that the status is not applicable (the input signals and comparison data may or may not be the same).

Timing Chart

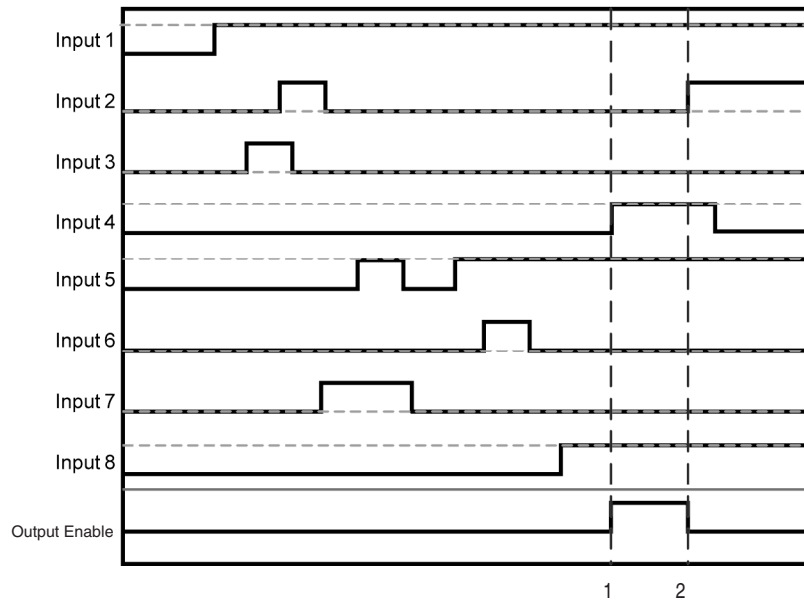

The horizontal broken lines in the above diagram represent the comparison data for each input.

1. Output Enable turns ON when all of the input signals match the comparison data.
2. Output Enable turns OFF when any of the input signals does not match the comparison data.

8-5 Command Reference: Function Blocks

8-5-1 Reset

Diagram

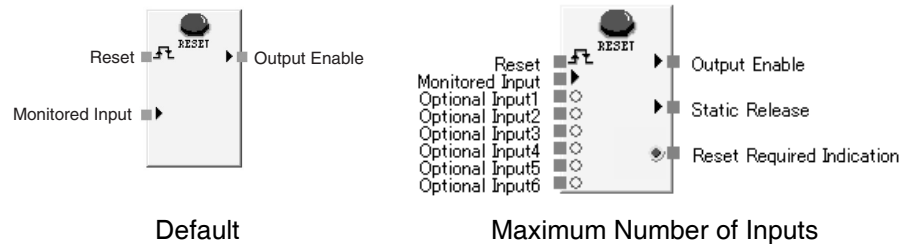

General Description

The Output Enable signal will turn ON if the Reset signal is correctly input while the input condition to the Reset function block is ON.

This function block can be used to prevent the machine from automatically reset, e.g., when the power to the NE1A-series Controller is turned ON, when the operating mode is changed (from IDLE Mode to RUN Mode), or when a signal from a safety input device turns ON.

Conditions for Output Enable Turning ON

- The Monitored Input and all enabled optional inputs must be ON. And the Reset signal must be input correctly.

Conditions for Static Release Turning ON

The Monitored Input and all enabled optional inputs must be ON.

Conditions for Reset Required Indication Turning ON

If the following condition is met, the Reset Required Indication will become a 1-Hz pulse output.

- The Monitored Input and all enabled optional inputs must be ON.
- And Output Enable must be OFF.

If the Reset Signal is set to Low-High-Low, the Reset Required Indication will turn ON when the next condition is met.

- The Reset signal turns ON.

Set Parameters

The Reset Signal can be set in NE1A-series Controllers with unit version 1.0 or later (including Controllers that support EtherNet/IP).

Parameter	Setting range	Default setting
Reset Signal	<ul style="list-style-type: none"> • Low-High-Low • Rising Edge Unit Ver. 1.0 or Later 	Low-High-Low

Low-High-Low

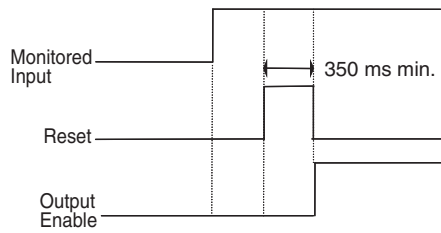

Rising Edge

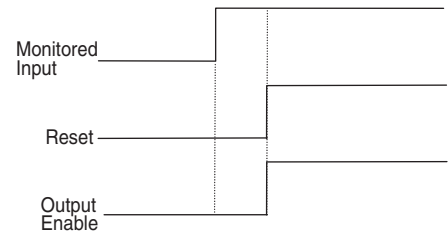

Number of Inputs Setting

The number of inputs can be increased on the In/Out Setting Tab Page in the function block property dialog box.

Parameter	Setting range	Default setting
Number of inputs	2 to 8 (Optional Input Settings)	2

Optional Output Settings

The outputs shown below can be used in the program. To enable either of these outputs, select the checkbox on the Out Point Tab Page of the function block properties dialog box.

- Static Release
- Reset Required Indication

Timing Chart

Reset Signal set to Low-High-Low:

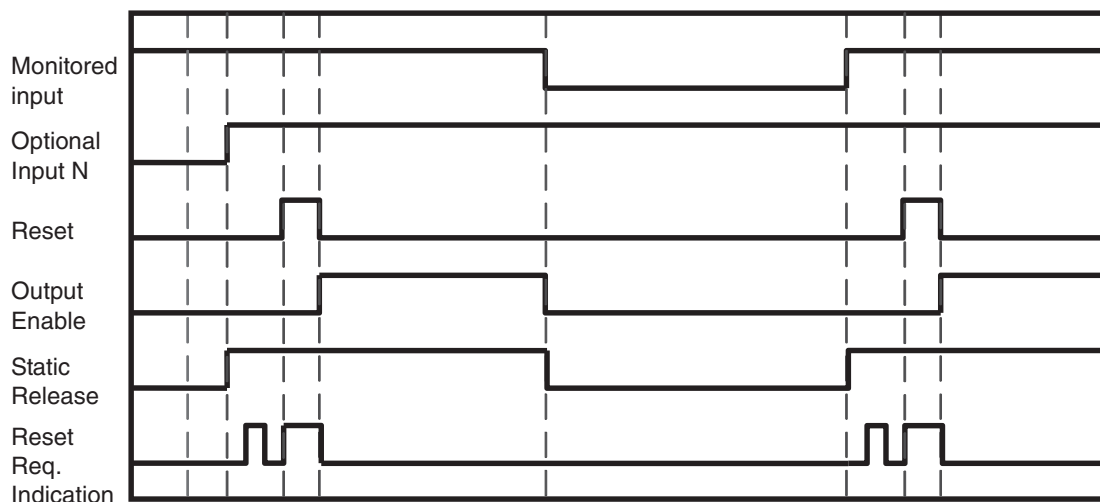

Idle to RUN

Reset Signal set to Rising Edge: **Unit Ver. 1.0 or Later**

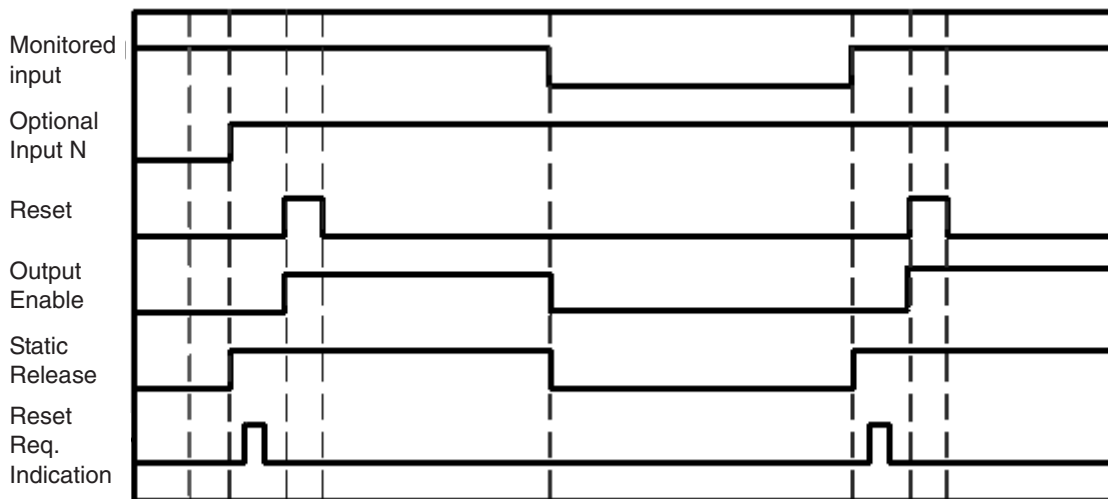

Idle to RUN

8-5-2 Restart

Diagram

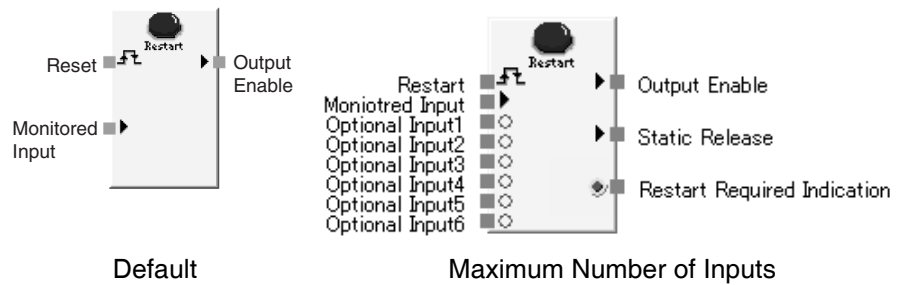

General Description

The Output Enable signal will turn ON if the Reset signal is correctly input while the input condition to the Restart function block is ON.

This function block can be used to prevent the machine from automatically restarting, e.g., when the power to the NE1A-series Controller is turned ON, when the operating mode is changed (from IDLE Mode to RUN Mode), or when a signal from a safety input device turns ON.

Functionally, the Reset function block and the Restart function block are equivalent.

Conditions for Output Enable Turning ON

- The Monitored Input and all enabled optional inputs must be ON. And the Reset signal must be input correctly.

Conditions for Static Release Turning ON

The Monitored Input and all enabled optional inputs must be ON.

Conditions for Restart Required Indication Turning ON

If the following condition is met, the Restart Required Indication will become a 1-Hz pulse output.

- The Monitored Input and all enabled optional inputs must be ON. And Output Enable must be OFF.

If the Reset Signal is set to Low-High-Low, the Restart Required Indication will turn ON when the next condition is met.

- The Restart signal must be ON.

Set Parameters

The Restart Signal can be set in NE1A-series Controllers with unit version 1.0 or later (including Controllers that support EtherNet/IP).

Parameter	Setting range	Default setting
Reset Signal	<ul style="list-style-type: none"> • Low-High-Low • Rising Edge Unit Ver. 1.0 or Later 	Low-High-Low

Low-High-Low

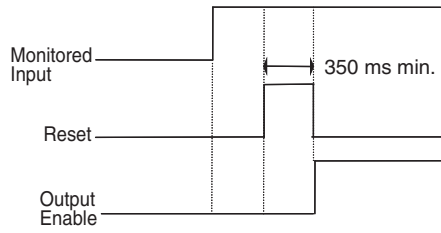

Rising Edge

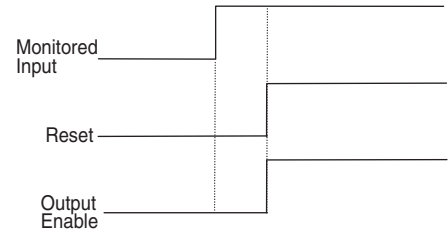

Number of Inputs Setting

The number of inputs can be increased on the In/Out Setting Tab Page in the function block property dialog box.

Parameter	Setting range	Default setting
Number of inputs	2 to 8 (Optional Input Settings)	2

Optional Output Settings

The outputs shown below can be used in the program. To enable either of these outputs, select the checkbox on the Out Point Tab Page of the function block properties dialog box.

- Static Release
- Restart Required Indication

Timing Chart

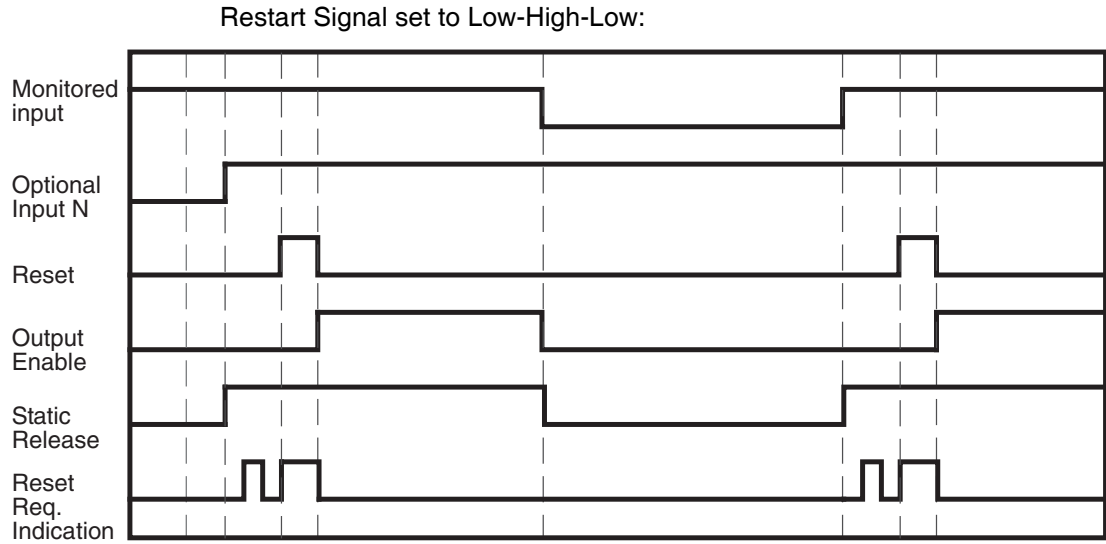

Idle to RUN

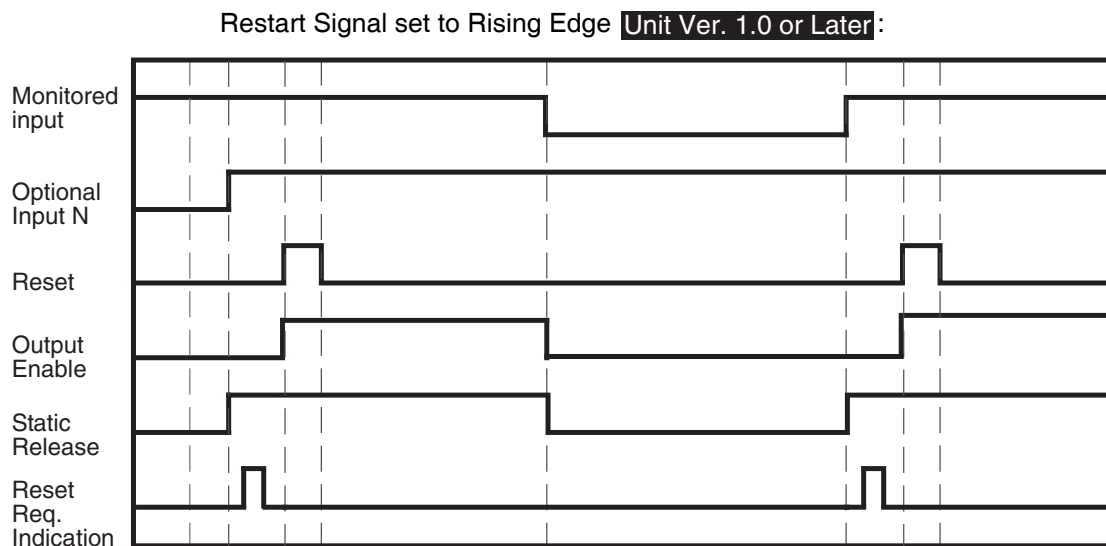

Idle to RUN

8-5-3 Emergency Stop Pushbutton Monitoring (E-Stop)

Diagram

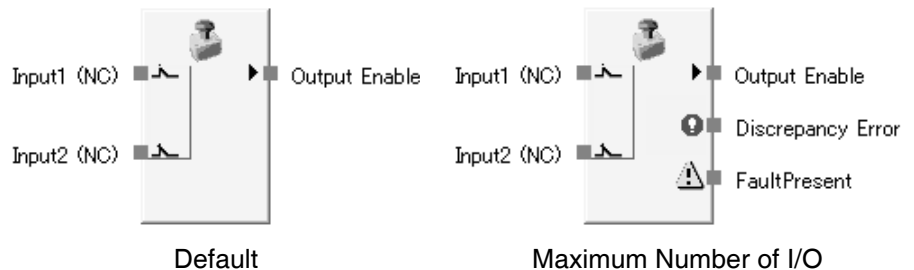

General Description

The Emergency Stop Pushbutton Monitoring function block allows the user to monitor an emergency stop pushbutton switch.

The Output Enable signal will turn ON if the input from the emergency pushbutton being monitored is active. The Output Enable signal will turn OFF if the input is inactive or if an error is detected for the function block.

IMPORTANT A manual reset function is required for emergency stop applications. When using the Emergency Stop Pushbutton Monitoring function block, you must also use the Reset function block. Refer to *A-1-1 Emergency Stop Application* for a Programming Example.

Set Parameters

Parameter	Setting range	Default setting
Input Type	Single Channel Dual Channel Equivalent Dual Channel Complementary	Dual Channel Equivalent
Discrepancy Time	0 to 30 s in 10-ms increments A discrepancy time check will not be performed if 0 is set.	30 ms

The discrepancy time must be equal to or greater than the NE1A-series Controller’s cycle time.

Optional Output Setting

The following error output can also be used in programming. To enable this optional output, select the checkbox on the Out Point Tab Page of the function block properties dialog box.

- Discrepancy Error

Fault Present Output Setting

A Fault Present output can also be used in programming. To enable this output, select the Fault Present checkbox on the Out Point Tab Page of the function block properties dialog box.

Truth Tables

Setting: Single Channel

Input 1 (NC)	Output Enable
0	0
1	1

0: OFF, 1: ON

Setting: Dual Channel Equivalent

Input 1 (NC)	Input 2 (NC)	Output Enable
0	0	0
0	1	0
1	0	0
1	1	1

0: OFF, 1: ON

Setting: Dual Channel Complementary

Input 1 (NC)	Input 2 (NO)	Output Enable
0	0	0
0	1	0
1	0	1
1	1	0

0: OFF, 1: ON

Error Handling and Error Resetting

Error condition	Behavior for error detection			Resetting the error condition
	Output Enable	Fault Present	Error output	
Discrepancy error	OFF (safety state)	ON	Discrepancy Error output: ON	Remove the cause of the error and then do the following: 1. Make the inputs inactive and then active again. 2. Or change the NE1A-series Controller's operating mode to IDLE Mode and then back to RUN Mode.

Timing Chart

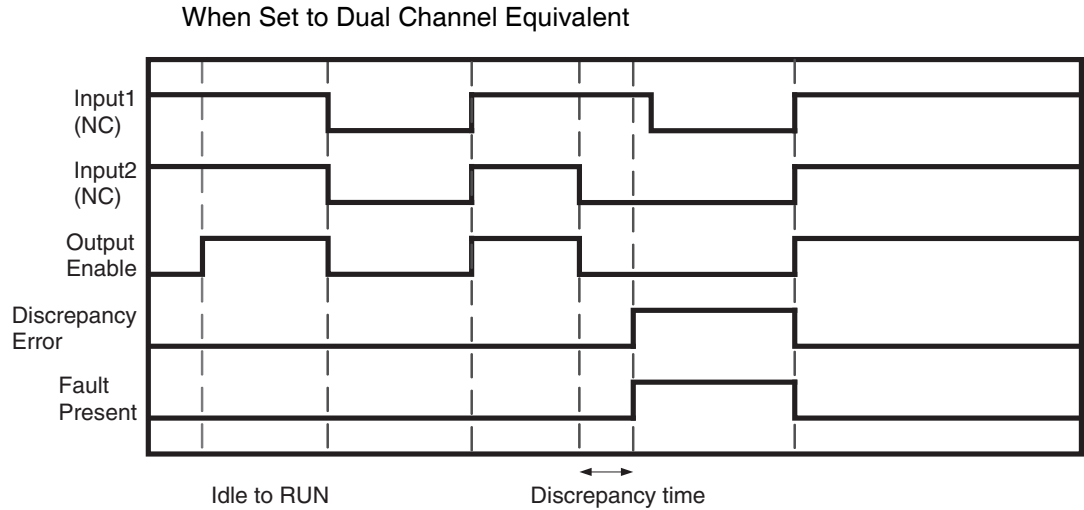

8-5-4 Light Curtain Monitoring

Diagram

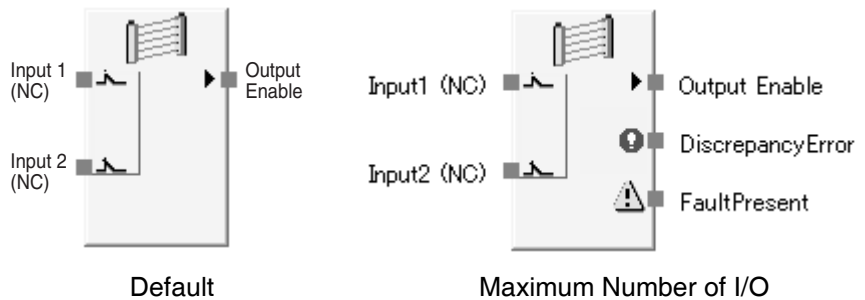

General Description

The Light Curtain Monitoring function block monitors a type-4 safety light curtain.

The Output Enable signal will turn ON if the input from the safety light curtain being monitored is active. The Output Enable signal will turn OFF if the input is inactive or if an error is detected for the function block.

Set Parameters

Parameter	Setting range	Default setting
Input type	Dual Channel Equivalent Dual Channel Complementary	Dual Channel Equivalent
Discrepancy time	0 to 30 s in 10-ms increments A discrepancy time check will not be performed if 0 is set.	30 ms

The discrepancy time must be equal to or greater than the NE1A-series Controller's cycle time.

Optional Output Setting

The following error output can also be used in programming. To enable this optional output, select the checkbox on the Out Point Tab Page of the function block properties dialog box.

- Discrepancy Error

Fault Present Output Setting

Fault Present output can also be used in programming. To enable this output, select the Fault Present checkbox on the Out Point Tab Page of the function block properties dialog box.

Truth Tables

Setting: Dual Channel Equivalent

Input 1 (NC)	Input 2 (NC)	Output Enable
0	0	0
0	1	0
1	0	0
1	1	1

0: OFF, 1: ON

Setting: Dual Channel Complementary

Input 1 (NC)	Input 2 (NO)	Output Enable
0	0	0
0	1	0
1	0	1
1	1	0

0: OFF, 1: ON

Error Handling and Error Resetting

Error condition	Behavior for error detection			Resetting the error condition
	Output Enable	Fault Present	Error output	
Discrepancy error	OFF (safety state)	ON	Discrepancy Error output: ON	Remove the cause of the error and then do the following: 1. Make the inputs inactive and then active again. 2. Or change the NE1A-series Controller's operating mode to IDLE Mode and then back to RUN Mode.

Timing Chart

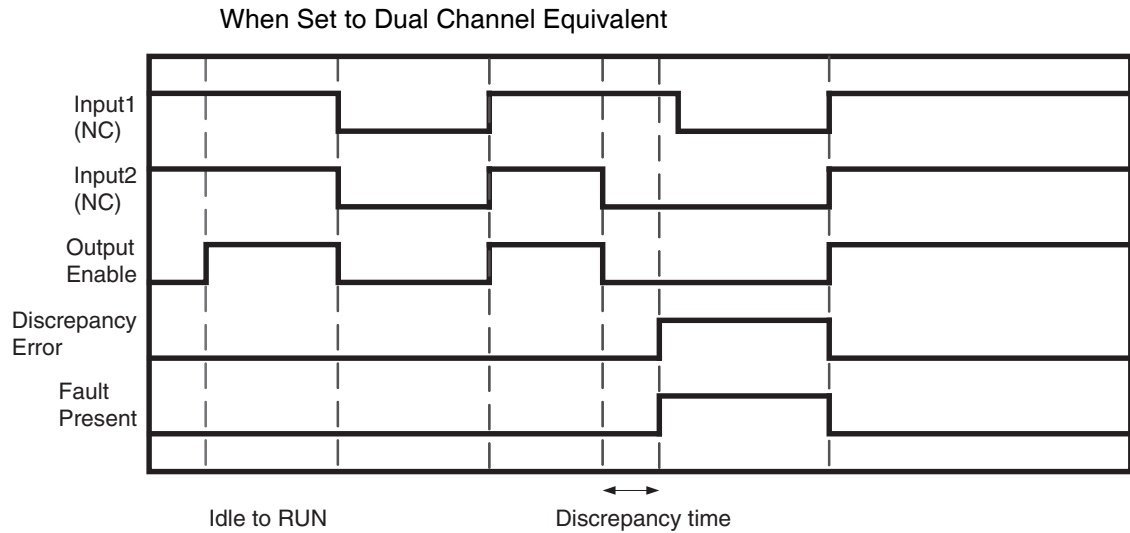

8-5-5 Safety Gate Monitoring

Diagram



General Description

The Safety Gate Monitoring function block monitors the status of a safety gate. Safety gate status is monitored using an input signal from a safety door switch or safety limit switch connected to the door.

The Output Enable signal will turn ON if the input from the switch being monitored is active. The Output Enable signal will turn OFF if the input is inactive or if an error is detected for the function block.

Function Tests

For some safety gate applications, safeguarding devices require physical verification that the device continues to operate properly (e.g., required for Category 2 safety gate applications).

If the function test is enabled for the Safety Gate Monitoring function block, a safety gate test in which the safety gate must be opened and then closed again can be added as a condition for turning ON the Output Enable signal.

If enabled, the safety gate test must be executed under the following conditions.

1. **Startup**
The safety gate test must be executed when the NE1A-series Controller is started (i.e., when the Controller’s operating mode changes from IDLE Mode to RUN Mode). If the test ends normally, the Output Enable signal will turn ON.
2. **Function Test Request from the Machine**
The safety gate test must be executed after the NE1A-series Controller detects the Function Test Signal from the machine turn ON and before the Function Test Signal turns ON again. If the Function Test Signal turns ON a second time before the safety gate test is completed normally, a function test error will occur, the Output Enable signal will turn OFF, and the Function Test Error signal will turn ON.
3. **Error Detected in Safety Gate Monitoring Function Block**
The safety gate test must be executed if a function test error, discrepancy error, or other function block error occurs (after removing the cause of the error).

The Function Test Required Signal from the Safety Gate Monitoring function block will turn ON when a safety gate test is required and it will remain ON until the safety gate test has been completed normally.

Set Parameters

Parameter	Setting range	Default setting
Input Type	Single Channel Dual Channel Equivalent (1 pair) Dual Channel Complementary (1 pair) Two Dual Channel Equivalent (2 pairs) Two Dual Channel Complementary (2 pairs)	Dual Channel Equivalent (1 pair)
Function Test	No Function Test/Function Test Required	No function test
Discrepancy Time Pair 1	0 to 30 s in 10-ms increments A discrepancy time check will not be performed if 0 is set.	30 ms
Discrepancy Time Pair 2		
Synchronization Time	0 to 30 s in 10-ms increments A synchronization time check will not be performed if 0 is set.	300 ms

The discrepancy time and synchronization time must be equal to or greater than the NE1A-series Controller’s cycle time.

Optional Output Settings

The following outputs can also be used in programming. To enable any of these optional outputs, select the checkbox on the Out Point Tab Page of the function block properties dialog box.

- Discrepancy Error Pair 1
- Discrepancy Error Pair 2
- Function Test Required Signal
- Synchronization Error
- Function Test Error

Fault Present Output Setting

Fault Present output can also be used in programming. To enable this output, select the Fault Present checkbox on the Out Point Tab Page of the function block properties dialog box.

Truth Tables

Setting: Single Channel

Input 1 (pair 1-NC)	Output Enable
0	0
1	1

0: OFF, 1: ON

Setting: Dual Channel Equivalent (1 Pair)

Input 1 (pair 1-NC)	Input 2 (pair 1-NC)	Output Enable
0	0	0
0	1	0
1	0	0
1	1	1

0: OFF, 1: ON

Setting: Dual Channel Complementary (1 Pair)

Input 1 (pair 1-NC)	Input 2 (pair 1-NO)	Output Enable
0	0	0
0	1	0
1	0	1
1	1	0

0: OFF, 1: ON

Setting: Two Dual Channel Equivalent (2 Pairs)

Input 1 (pair 1-NC)	Input 2 (pair 1-NC)	Input 3 (pair 2-NC)	Input 4 (pair 2-NC)	Output Enable
0	0	0	0	0
0	0	0	1	0
0	0	1	0	0
0	0	1	1	0
0	1	0	0	0
0	1	0	1	0
0	1	1	0	0
0	1	1	1	0
1	0	0	0	0
1	0	0	1	0
1	0	1	0	0
1	0	1	1	0
1	1	0	0	0
1	1	0	1	0
1	1	1	0	0
1	1	1	1	1

0: OFF, 1: ON

Setting: Two Dual Channel Complementary (2 Pairs)

Input 1 (pair 1-NC)	Input 2 (pair 1-NO)	Input 3 (pair 2-NC)	Input 4 (pair 2-NO)	Output Enable
0	0	0	0	0
0	0	0	1	0
0	0	1	0	0
0	0	1	1	0
0	1	0	0	0
0	1	0	1	0
0	1	1	0	0
0	1	1	1	0
1	0	0	0	0
1	0	0	1	0
1	0	1	0	1
1	0	1	1	0
1	1	0	0	0
1	1	0	1	0
1	1	1	0	0
1	1	1	1	0

0: OFF, 1: ON

Error Handling and Error Resetting

Error condition	Behavior for error detection			Resetting the error condition
	Output Enable	Fault Present	Error output	
Discrepancy error at pair 1	OFF (safety state)	ON	Discrepancy Error Pair 1: ON	1. Function Test Disabled Remove the cause of the error and then make the inputs in active and then active again (See note.), or change the NE1A-series Controller's operating mode to IDLE Mode and then back to RUN Mode. 2. Function Test Required If Function Test Required is active: Remove the cause of the error and then make the inputs active, inactive, and then active again (i.e., perform the safety gate test). If Function Test Required is inactive: Remove the cause of the error and then make the inputs in active and then active again.
Discrepancy error at pair 2			Discrepancy Error Pair 2: ON	
Function test error Safety gate test was not performed normally between Function Test signals.			Function Test Error: ON	
Synchronization error			Synchronization Test Error: ON	

Note If a discrepancy error occurs in one of the pairs when set to Dual Channel Equivalent (2 pairs) or Dual Channel Complementary (2 pairs), to reset the error make input pairs 1 and 2 both inactive and then active.

Timing Charts

Single Channel, Function Test Set to Enabled

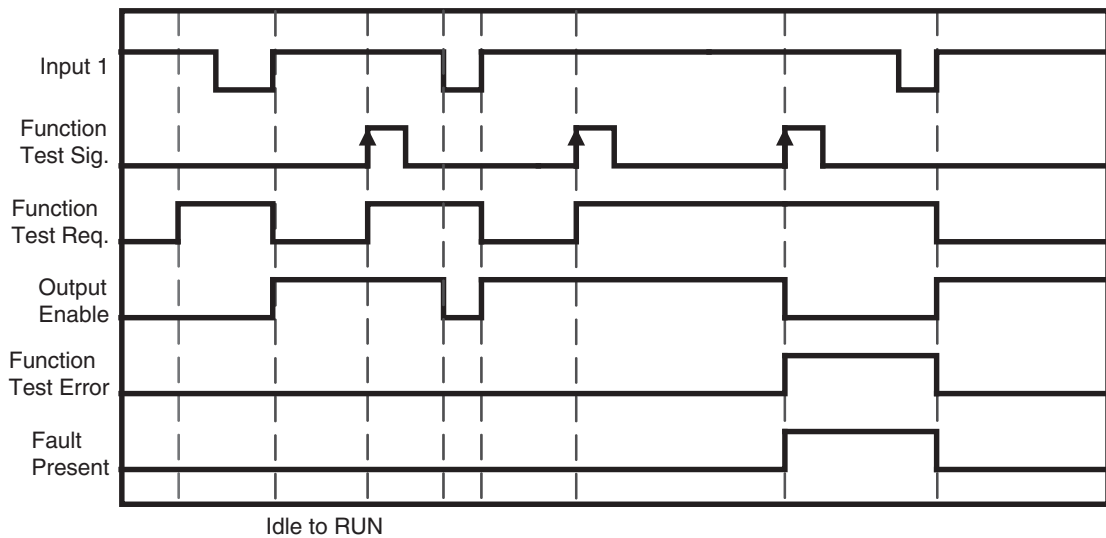

Dual Channel Equivalent, Function Test Set to Disabled

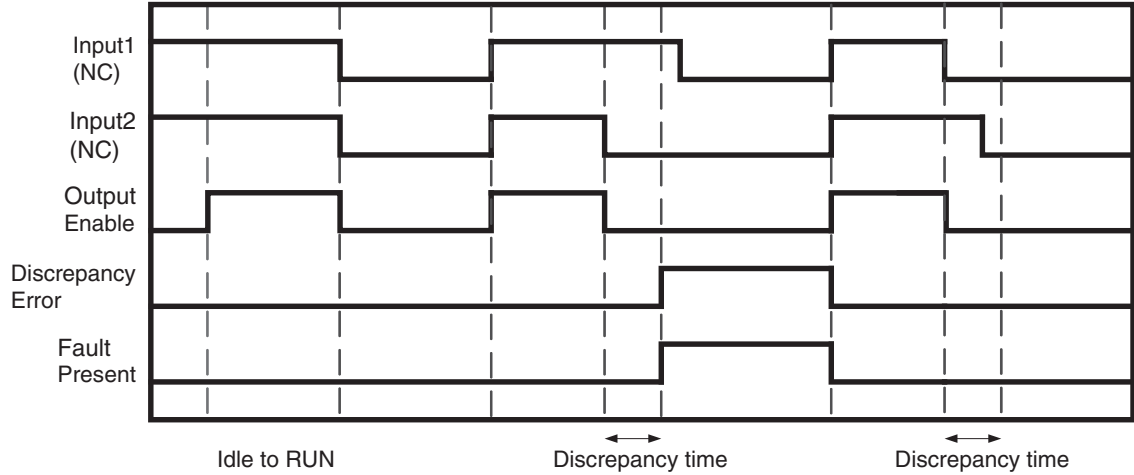

Dual Channel Equivalent (2 pairs), Function Test Set to Disabled

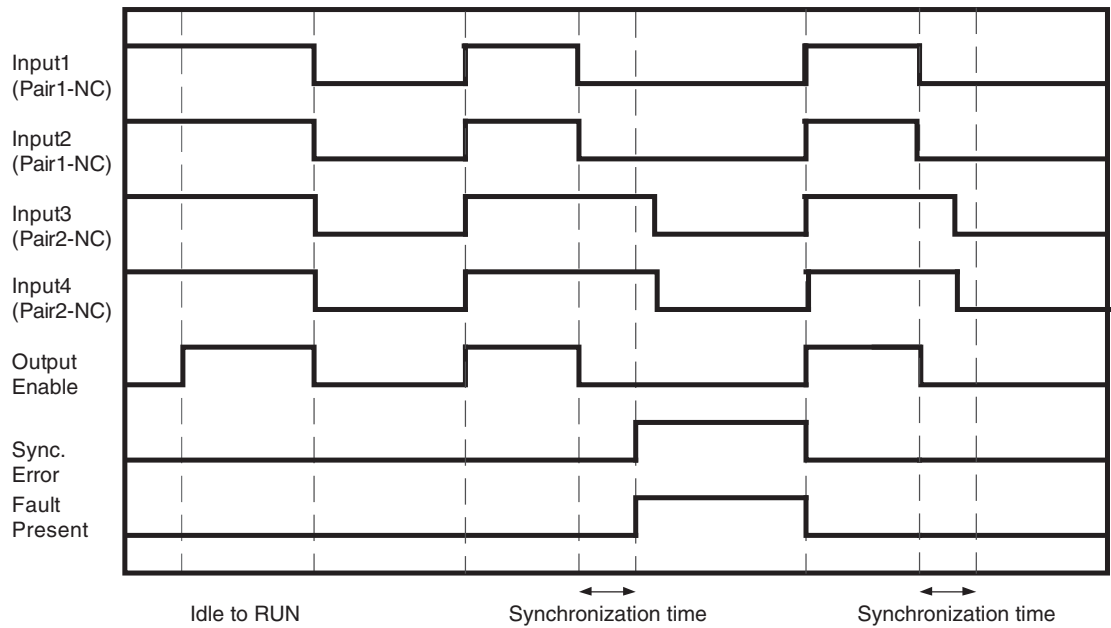

8-5-6 Two-hand Control

Diagram

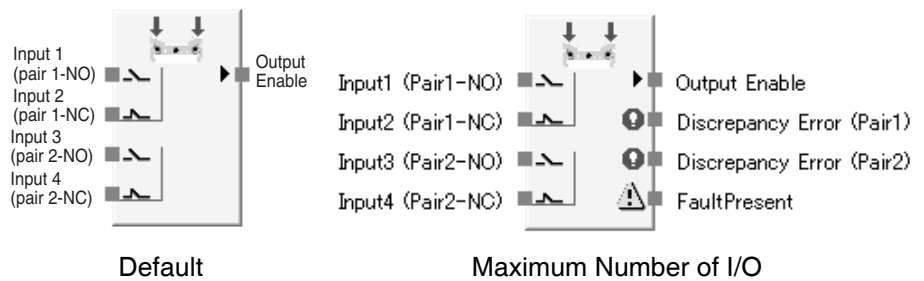

General Description

The Two-hand Control function block enables monitoring the status of a two-hand switch.

The Two-hand Control function block can be used with a suitable 2-hand switch to meet the requirements of type III C in EN 574, *Two-hand Control Devices, Functional Aspect – Principle for Design*.

The Output Enable signal will turn ON only if both inputs from the two-hand switch are active and satisfy the requirements of EN 574. The Output Enable signal will turn OFF if the inputs from the two-hand switch do not satisfy the requirements of EN 574, an input is inactive, or if an error is detected for the function block.

Set Parameters

Parameter	Setting range	Default setting
Discrepancy Time Pair 1	0 to 500 ms in 10-ms increments	30 ms
Discrepancy Time Pair 2	A discrepancy time check will not be performed if 0 is set.	

The discrepancy times must be equal to or greater than the NE1A-series Controller’s cycle time.

Optional Output Settings

The following error outputs can also be used in programming. To enable either of these optional outputs, select the checkbox on the Out Point Tab Page of the function block properties dialog box.

- Discrepancy Error Pair 1
- Discrepancy Error Pair 2

Fault Present Output Setting

Fault Present output can also be used in programming. To enable this output, select the Use Fault Present checkbox on the Out Point Tab Page of the function block properties dialog box.

Truth Table

Input 1 (Pair 1-NO)	Input 2 (Pair 1-NC)	Input 3 (Pair 2-NO)	Input 4 (Pair 2-NC)	Output Enable
0	0	0	0	0
0	0	0	1	0
0	0	1	0	0
0	0	1	1	0
0	1	0	0	0
0	1	0	1	0
0	1	1	0	0
0	1	1	1	0
1	0	0	0	0
1	0	0	1	0
1	0	1	0	1
1	0	1	1	0
1	1	0	0	0
1	1	0	1	0
1	1	1	0	0
1	1	1	1	0

0: OFF, 1: ON

Error Handling and Error Resetting

Error condition	Behavior for error detection			Resetting the error condition
	Output Enable	Fault Present	Error output	
Discrepancy Error at Pair 1	OFF (safety state)	ON	Discrepancy Error Pair 1: ON	Remove the cause of the error and then do the following: 1. Make the both input pair 1 and pair 2 inactive and then active again. 2. Or change the NE1A-series Controller's operating mode to IDLE Mode and then back to RUN Mode.
Discrepancy Error at Pair 2			Discrepancy Error Pair 2: ON	

Note The Output Enable signal will not turn ON if the synchronization time requirement is not met (i.e., operation inputs for both hands must be completed within 500 ms), but this is **not** considered an error.

Timing Chart

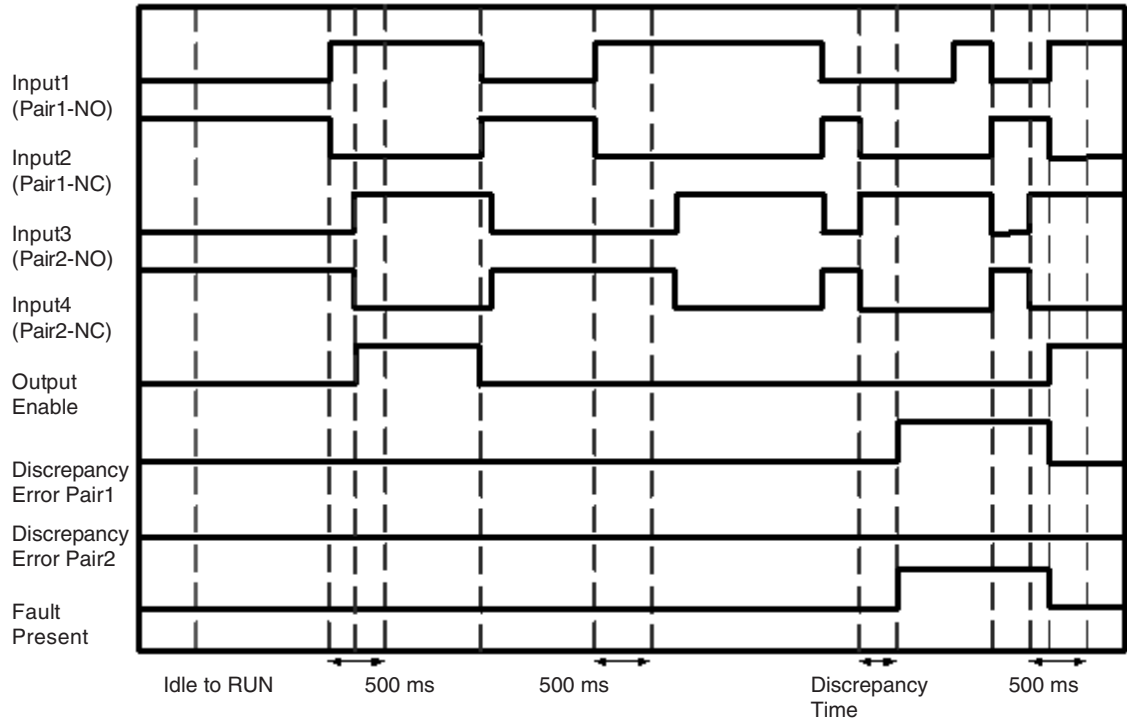

8-5-7 OFF-delay Timer

Diagram

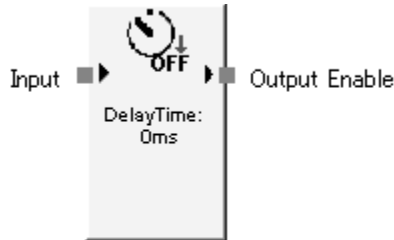

General Description

The OFF-delay Timer function block performs a timer operation for an OFF delay set in 10-ms increments. The range for this delay is from 0 ms to 300 s.

Set Parameters

Parameter	Setting range	Default setting
Delay Time	0 to 300 s in 10-ms increments	0 ms

The delay time must be equal to or greater than the NE1A-series Controller's cycle time.

Timing Chart

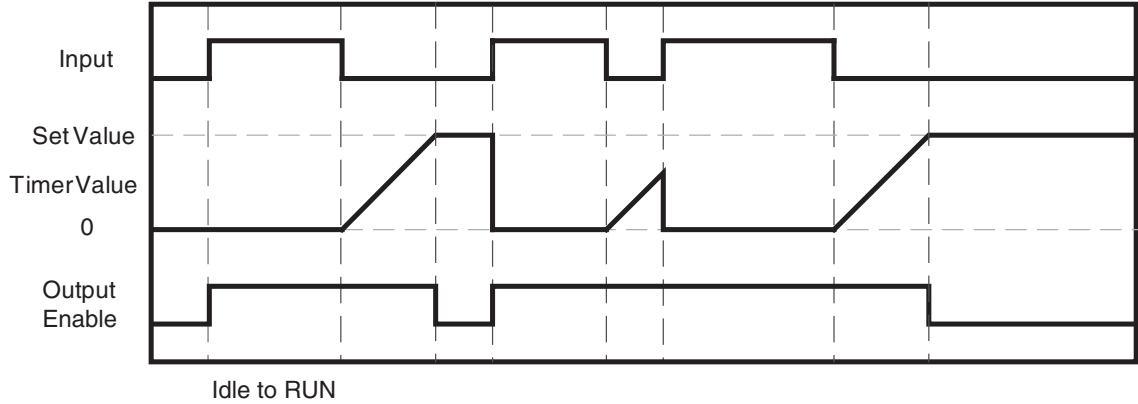

8-5-8 ON-delay Timer

Diagram

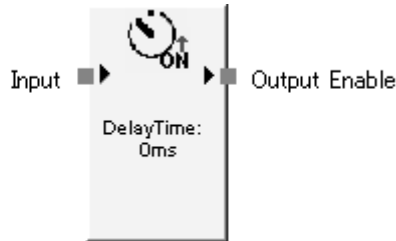

General Description

The ON-delay Timer function block performs a timer operation for an ON delay set in 10-ms increments. The range for this delay is from 0 ms to 300 s.

Set Parameters

Parameter	Setting range	Default setting
Delay Time	0 to 300 s in 10-ms increments	0 ms

The delay time must be equal to or greater than the NE1A-series Controller's cycle time.

Timing Chart

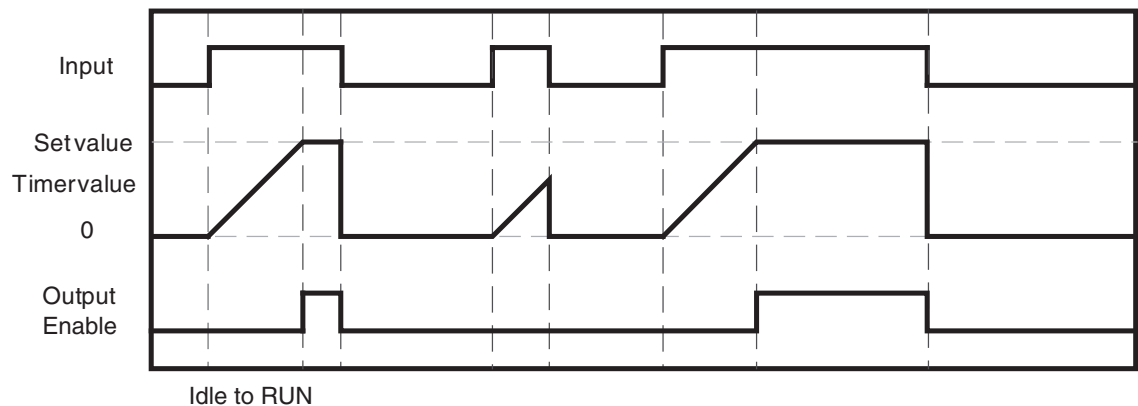

8-5-9 User Mode Switch

Diagram

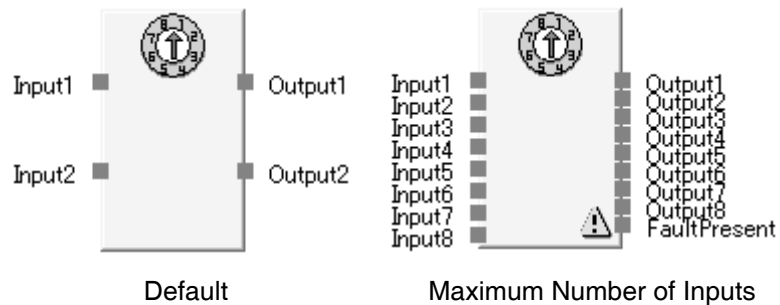

General Description

The User Mode Switch function block is used to monitor an operating mode switch in the user system or device.

The operating mode switch that can be connected with this function block must be a 1-of-N type switch (i.e., one of N contacts is ON). The function block supports a maximum of eight inputs and corresponding outputs.

The output corresponding to the input that is active is turned ON. If an error is detected for the function block, however, all outputs will turn OFF.

Optional Output Settings

The number of I/O can be increased on the In/Out Setting Tab Page in the function block property dialog box.

Parameter	Setting range	Default setting
Number of inputs	2 to 8	2
Number of outputs	2 to 8	2

Fault Present Output Setting

Fault Present output can also be used in programming.

To enable this output, select the Fault Present checkbox on the In/Out Setting Tab Page of the function block properties dialog box.

Truth Table

Inputs								Outputs							
1	2	3	4	5	6	7	8	1	2	3	4	5	6	7	8
1	0	0	0	0	0	0	0	1	0	0	0	0	0	0	0
0	1	0	0	0	0	0	0	0	1	0	0	0	0	0	0
0	0	1	0	0	0	0	0	0	0	1	0	0	0	0	0
0	0	0	1	0	0	0	0	0	0	0	1	0	0	0	0
0	0	0	0	1	0	0	0	0	0	0	0	1	0	0	0
0	0	0	0	0	1	0	0	0	0	0	0	0	1	0	0
0	0	0	0	0	0	1	0	0	0	0	0	0	0	1	0
0	0	0	0	0	0	0	1	0	0	0	0	0	0	0	1

0: OFF, 1: ON

Error Handling and Error Resetting

Error condition	Behavior for error detection		Resetting the error condition
	Output	Fault Present	
More than one input was ON for more than 2 s	OFF (safety state)	ON	Remove the cause of the error. (Correct system so that only 1 contact is ON.)
All inputs were OFF for more than 2 s			

Note If more than one input is ON, the output corresponding to the first input to turn ON will turn ON for 2 s. If more than one input turns ON in the same NE1A-series Controller cycle, then all outputs will turn OFF.

Timing Chart

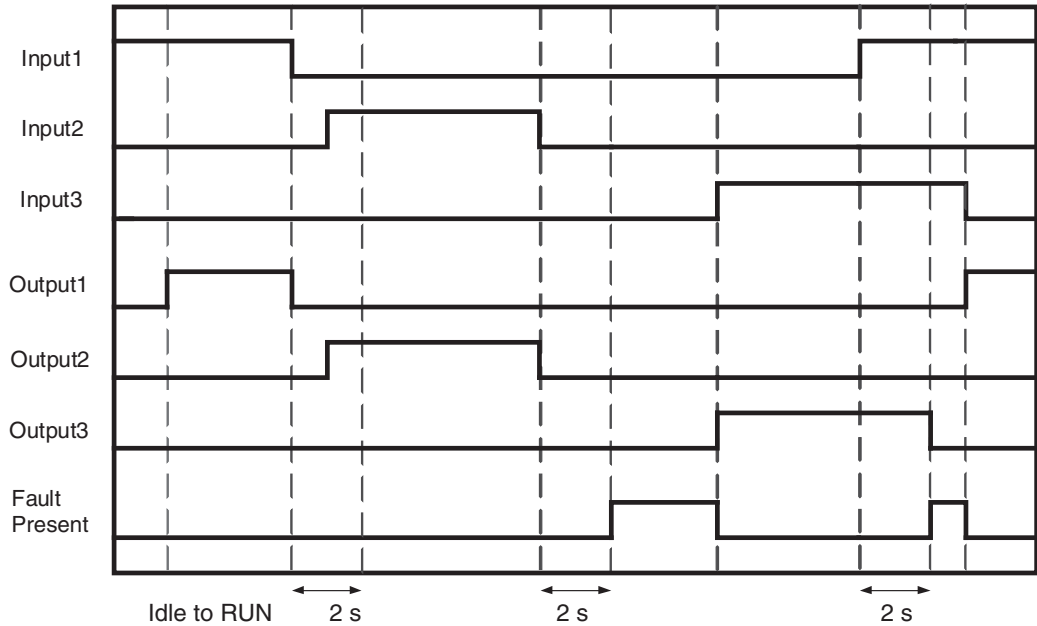

8-5-10 External Device Monitoring (EDM)

Diagram

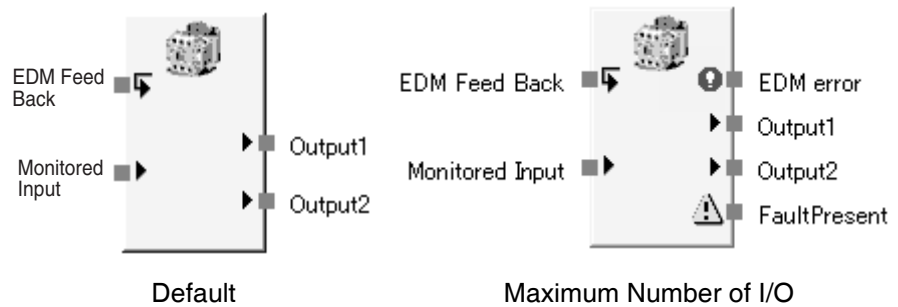

General Description

The External Device Monitoring function block evaluates the input signal and the status of an external device and outputs safety outputs to an external device.

If the input signal turns ON, the Output 1 and Output 2 signals will turn ON. When this occurs, the status of the feedback signal must change within the specified time. If the input signal turns OFF, the Output 1 and Output 2 signals will turn OFF. When this occurs, the status of the feedback signal must change within the specified time.

If the status of the feedback signal does not change within the specified maximum feedback time, an EDM error will occur, the Output 1 and Output 2 signals will turn OFF, and the EDM Error signal will turn ON.

Set Parameters

Parameter	Setting range	Default setting
Maximum Feedback Time (T_{EDM})	100 to 1000 ms in 10-ms increments	300 ms

The Maximum Feedback Time must be equal to or greater than the cycle time of the NE1A-series Controller.

The network response time must be taken into consideration when inputting the feedback signal from a remote device.

Optional Output Settings

The following outputs can also be used in programming. To enable either of these optional outputs, select the checkbox on the Out Point Tab Page of the function block properties dialog box.

- EDM error
- Output 2

Fault Present Output Setting

Fault Present output can also be used in programming. To enable this output, select the Fault Present checkbox on the Out Point Tab Page of the function block properties dialog box.

Error Handling and Error Resetting

Error condition	Behavior for error detection			Resetting the error condition
	Outputs 1 and 2	Fault Present	Error output	
EDM feedback time error	OFF (safety state)	ON	EDM Error output: ON	Remove the cause of the error and turn ON the safety input.

Timing Chart

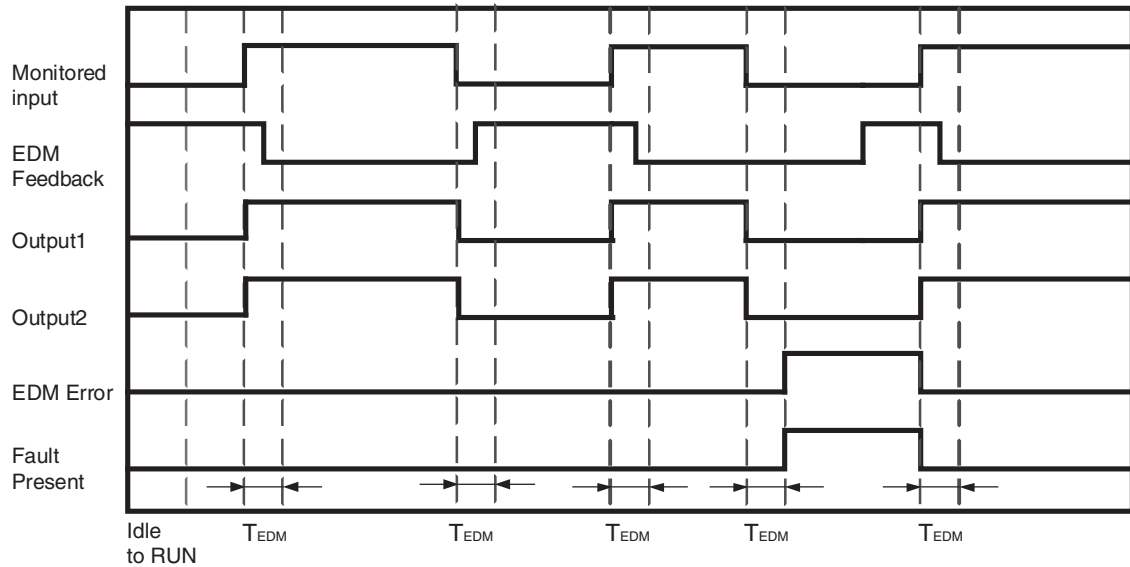

8-5-11 Routing

Diagram

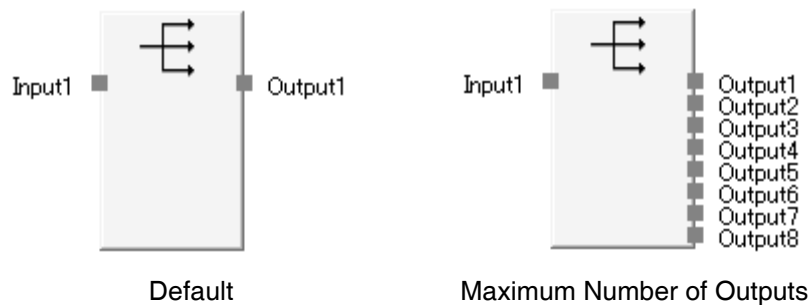

General Description

The Routing function block routes one input signal to a maximum of eight output signals. It is used to output a signal to more than one output tag.

Optional Output Settings

The number of outputs can be increased on the In/Out Setting Tab Page in the function block property dialog box.

Parameter	Setting range	Default setting
Number of outputs	1 to 8	1

Truth Table

Truth Table for Routing Evaluation

Input 1	Output 1	Output 2	Output 3	Output 4	Output 5	Output 6	Output 7	Output 8
0	0	0	0	0	0	0	0	0
1	1	1	1	1	1	1	1	1

0: OFF, 1: ON

8-5-12 Muting Unit Ver. 1.0 or Later

Diagram

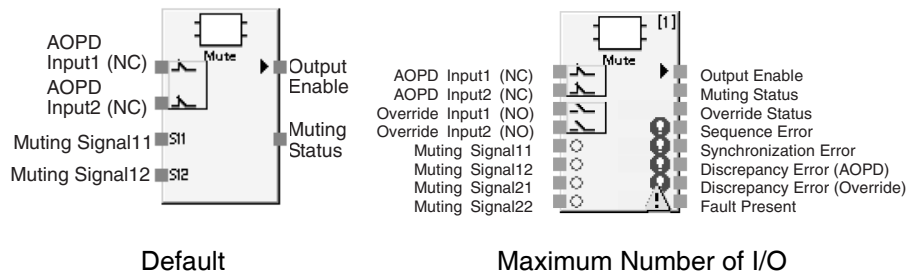

General Description

This function can be used with unit version 1.0 or later (including Controllers that support EtherNet/IP).
 The Muting function block provides both muting and override functions.

Muting

Muting can be used to temporarily disable safety functions, e.g., so that workpieces or palettes can pass through the detection area of a light curtain. The Muting function block temporarily disables the input signal (AOPD input) of a light curtain while the muting condition is met and keeps the Output Enable signal turned ON even if the light curtain is interrupted until the muting end condition is met.

Supported Muting Applications

Any of the following four muting modes can be selected to enable typical muting applications.

Muting Mode	Application
Parallel Muting with 2 Sensors	This mode is suitable for applications at a conveyor entrance. Use this mode when two Retro-reflective Photoelectric Sensors are set up as the muting sensors with intersecting detection zones.
Sequential Muting (Forward Direction)	This mode is suitable for applications at a conveyor entrance. Use this mode when four Through-beam Photoelectric Sensors are set up as the muting sensors.
Sequential Muting (Both Directions)	This mode is suitable for applications at a conveyor entrance or exit. Use this mode when four Through-beam Photoelectric Sensors are set up as the muting sensors.
Position Detection	This mode is suitable for applications in which the operator sets the workpiece and then the workpiece is moved to the processing area by a turn table or workpiece conveyor robot. Muting is enabled by detecting that the robot is in a safe location using a limit switch or other device. Use this mode to temporarily disable the light curtain when the operator sets the workpiece at the conveyor entrance.

Muting Starting, Ending, and Stopping Conditions

Starting Condition

If an input is normally received for the Muting Signal when the Muting function block is in a normal state, the AOPD input is ON (the light curtain is not obstructed), and the Output Enable is ON, muting status will be enabled and Muting Status will turn ON.

Ending Condition

Muting status will be cleared and Muting Status will turn OFF when the following conditions occur.

Muting Mode	Ending condition
Position Detection	Muting Signal 11 turns OFF.
Parallel Muting with 2 Sensors	Muting Signal 11 or 12 turns OFF.
Sequential Muting (Forward Direction)	Muting Signal 11, 12, and 21 turn OFF.
Sequential Muting (Both Directions)	Input Sequences Muting Signal 11, 12, and 21 turn OFF.
	Output Sequences Muting Signal 12, 21, and 22 turn OFF.

Stopping Condition

Muting status will be stop and Muting Status will turn OFF when the following conditions occur.

- The maximum muting time expires.
- A discrepancy error occurs for the AOPD input.
- A discrepancy error occurs for the override input.

Muting status will be resumed when the muting starting condition is met again.

Note In the explanation above, the muting sensors are ON when the workpiece is detected and OFF when it is not detected.

Note When the operating mode of the NE1A-series Controller switches from Idle to Run, input data from the slaves will be OFF until communications are established. If slave data is used for the AOPD input, Fault Present and Sequence Error will turn ON immediately after entering RUN Mode. When the AOPD input turns ON, Fault Present will turn OFF. When the muting starting condition is met, Sequence Error will turn OFF.

Override Function

The override function can be used, for example, to force a machine to operate to remove an object that has stopped in the detection area of the light curtain. The override function enables turning ON the Output Enable signal even when the muting starting condition has not been met.

Override Starting and Stopping Conditions

Starting Conditions

The override will be started when all of the following conditions are met and Output Enable, Muting Status, and Override Status will turn ON.

- At least one of the muting signals is ON (i.e., the muting sensor is detecting a workpiece).
- The AOPD input is inactive (i.e., the lighting curtain is obstructed).
- The override input is active.

Ending Condition

The override will be stopped when any of the following conditions is met and Muting Status and Override Status will turn OFF.

- All of the muting signals are ON (i.e., the muting sensor is not detecting a workpiece).
- The maximum override time has expired.
- The override input is inactive.

Set Parameters

Parameter	Setting range	Default setting
Input Type of AOPD	<ul style="list-style-type: none"> • Dual Channel Equivalent (NC/NC) • Dual Channel Complementary (NC/NO) 	Dual Channel Equivalent
Discrepancy Time (AOPD)	0 to 500 ms in 10-ms increments (See note.) A discrepancy time check will not be performed if 0 is set.	30 ms
Input Type of Override	<ul style="list-style-type: none"> • Single Channel • Dual Channel Equivalent (NO/NO) • Dual Channel Complementary (NC/NO) • Not used. 	Not used.
Discrepancy Time (Override)	0 to 500 ms in 10-ms increments (See note.) A discrepancy time check will not be performed if 0 is set.	30 ms
Max. Override Time	500 ms to 127.5 s in 500-ms increments	60 s
Muting Mode	Position detection Parallel Muting with 2 Sensors Sequential Muting (Forward Direction) Sequential Muting (Both Directions)	Parallel Muting with 2 Sensors
Max Muting Time	0 ms to 127.5 s in 500-ms increments The muting time will be unlimited if 0 is set.	60 s
Synchronization Time (See note 2.)	30 ms to 3 s in 10-ms increments (See note 1.)	3 s

- Note**
- (1) The timer SV must be longer than the NE1A-series Controller's cycle time.
 - (2) Sets the time between Muting Signal 11 and Muting Signal 12 or between Muting Signal 21 and Muting Signal 22.

Optional Output Settings

The following outputs can also be used in programming. To enable any of these optional outputs, select the checkbox on the Output Point Tab Page of the function block properties dialog box.

- Override Status
- Synchronization Error
- Sequence Error
- Discrepancy Error (AOPD)
- Discrepancy Error (Override)

Fault Present Output Setting

A Fault Present output can also be used in programming.

To enable this output, select the Fault Present checkbox on Output Point Tab Page of the function block properties dialog box.

Error Handling and Error Resetting

Synchronization Error

A synchronization error can be detected in any mode other than Position Detection Mode.

A synchronization error will occur and Synchronization Error will turn ON when the time difference between input signals for the muting signals (i.e., muting sensors) exceeds the synchronization time that has been set. If the AOPD input turns OFF (i.e., if the light curtain is obstructed) while there is a synchronization error, Output Enable will turn OFF and Fault Present will turn ON.

The condition for a synchronization error are give for each muting mode in the following table.

Muting Mode	Condition for synchronization error
Position Detection	Not detected.
Parallel Muting with 2 Sensors	The time difference between muting signal 11 and muting signal 12 has exceeded the set value of the synchronization time.
Sequential Muting (Forward Direction)	The time difference between muting signal 11 and muting signal 12 has exceeded the set value of the synchronization time.
Sequential Muting (Both Directions)	Input Sequence The time difference between muting signal 11 and muting signal 12 has exceeded the set value of the synchronization time.
	Output Sequence The time difference between muting signal 21 and muting signal 22 has exceeded the set value of the synchronization time.

Sequence Error

A sequence error will occur and Sequence Error will turn ON when the detection order of muting signals (i.e., muting sensors)

If the AOPD input turns OFF (i.e., if the light curtain is obstructed) while there is a sequence error, Output Enable will turn OFF and Fault Present will turn ON.

The following table lists the conditions for sequence errors for each muting mode.

Muting Mode	Normal sequence	Error sequence that may cause an error
Position Detection	AOPD input turning OFF is detected while muting signal 11 is ON.	AOPD input turning OFF is detected while muting signal 11 is OFF.
Parallel Muting with 2 Sensors	Muting signal 11 is detected, and then muting signal 12 is detected.	<ul style="list-style-type: none"> • Muting signal 12 is detected before muting signal 11 is detected. • Muting signals 11 and 12 are detected simultaneously. • AOPD turns OFF before the normal sequence is detected.
Sequential Muting (Forward Direction)	Muting signal 11 is detected, and then muting signal 12 is detected.	<ul style="list-style-type: none"> • Muting signal 12 is detected before muting signal 11 is detected. • Muting signals 11 and 12 are detected simultaneously. • AOPD turns OFF before the normal sequence is detected. • Muting signal 21 or 22 is detected before muting signal 11 is detected. • Muting signal 21 or 22 is detected before muting signal 12 is detected.
Sequential Muting (Both Directions)	Input Sequence Muting signal 11 is detected, and then muting signal 12 is detected.	<ul style="list-style-type: none"> • Muting signal 12 is detected before muting signal 11 is detected. • Muting signals 11 and 12 are detected simultaneously. • AOPD turns OFF before the normal sequence is detected. • Muting signal 21 or 22 is detected before muting signal 11 is detected. • Muting signal 21 or 22 is detected before muting signal 12 is detected.
	Output Sequence Muting signal 22 is detected, and then muting signal 21 is detected.	<ul style="list-style-type: none"> • Muting signal 12 or 21 is detected before muting signal 22 is detected. • Muting signals 21 and 22 are detected simultaneously. • AOPD turns OFF before the normal sequence is detected. • Muting signal 11 or 12 is detected before muting signal 21 is detected. • Muting signal 11 or 12 is detected before muting signal 22 is detected.

Note All muting signals must turn OFF before the normal sequence.

Resetting Errors

Error	Operation when error occurs			Resetting
	Output Enable	Fault Present	Error output	
Discrepancy error during AOPD input	OFF (safe state)	ON	Discrepancy Error (AOPD): ON	<ul style="list-style-type: none"> Change the light curtain input pair (AOPD inputs 1 and 2) from inactive to active. Change the NE1A-series Controller to IDLE Mode and then return it to RUN Mode.
Discrepancy error during override input			Discrepancy Error (Override): ON	
Synchronization error	ON (See note.)	OFF (See note.)	Synchronization Error: ON	<ul style="list-style-type: none"> The error will be reset the next time a normal muting status is enabled. Change the NE1A-series Controller to IDLE Mode and then return it to RUN Mode.
Sequence error			Sequence Error: ON	

Note If the AOPD input turns OFF (i.e., light curtain obstructed) while there is a synchronization or sequence error, Output Enable will turn OFF and Fault Present will turn ON.

Example Muting System Configurations

■ Parallel Muting with 2 Sensors

In this example, two Retro-reflective Photoelectric Sensors are set up as the muting sensors with intersecting detection zones.

Use this configuration when the workpiece length (L) is not fixed or not long enough.

Block Diagram

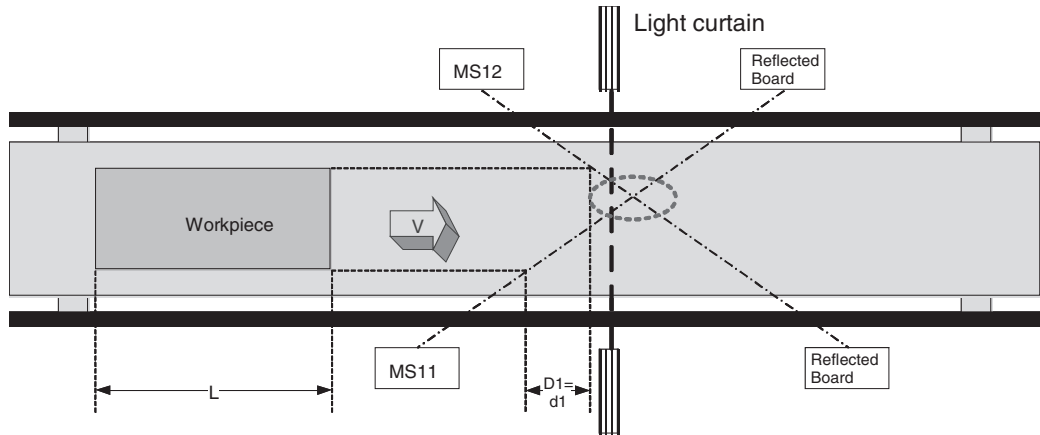

MS11: Muting sensor connected to Muting Signal 11

MS12: Muting sensor connected to Muting Signal 12

Note The intersection of the two sensors must be after the light curtain.

Muting Sequence

1. In the block diagram above, the light is not interrupted between MS11 and MS12 and the light curtain, so the Output Enable signal is ON.
2. As the workpiece moves to the right and MS11 and MS12 go ON in order, muting is enabled.
3. As the workpiece continues advancing, the Output Enable signal is kept ON even if the light curtain is obstructed.

4. As the workpiece continues advancing, the light from MS11 is no longer interrupted by the workpiece, the muting status is cleared and the Muting Status will go OFF.

Setup Distances

The following formula shows the minimum distance of D1 required for the muting sensors to provide effective muting function operation:

$$\text{Formula 1: } D1 < L$$

L: Length of the workpiece

The following formula shows the maximum distance of d1 required for the muting sensors to provide effective muting function operation:

$$\text{Formula 2: } V \times T1_{\min} < d1 < V \times T1_{\max}$$

V: Transit speed of the workpiece

T1min: NE1A-series Controller cycle time

T1max: Synchronization time setting time

The default setting is 3 s.

D1 must satisfy formula 1 and d1 must satisfy formula 2 in order for the muting function to be operate effectively. These distance settings must prevent a passing person from enabling the muting function. Also, the light curtain and muting sensors must be setup so that a workpiece passes by all of the muting sensors before the next workpiece arrives at the muting sensors.

■ **Timing Chart**

Normal Operation

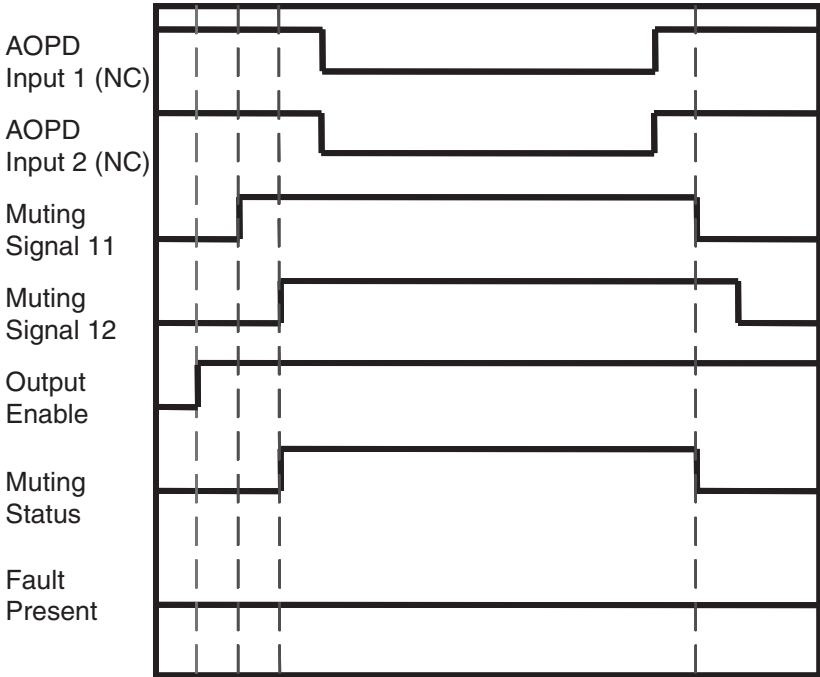

Idle to RUN
Synchronization time

Synchronization Error

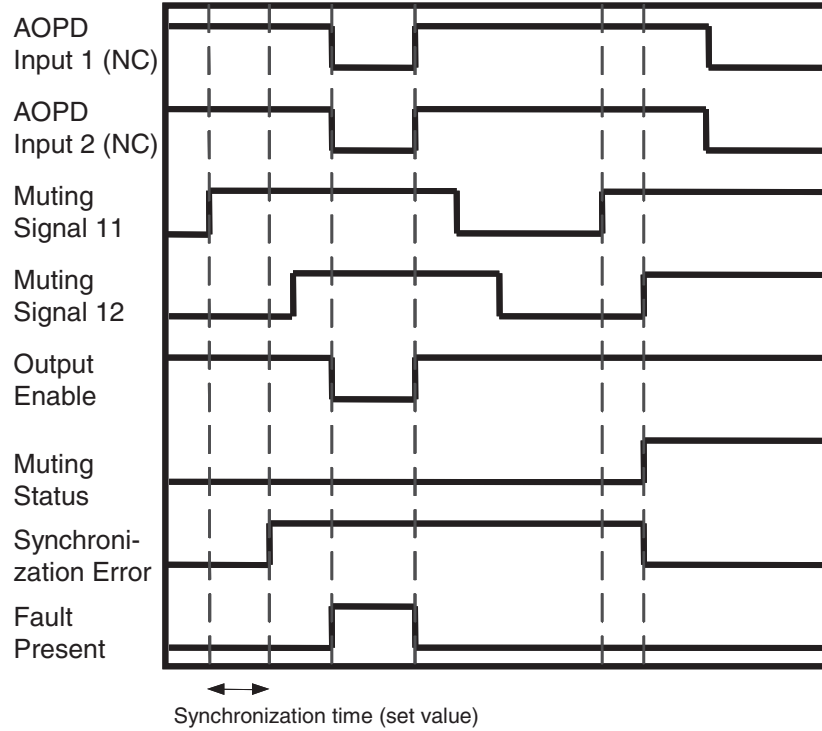

Sequence Error

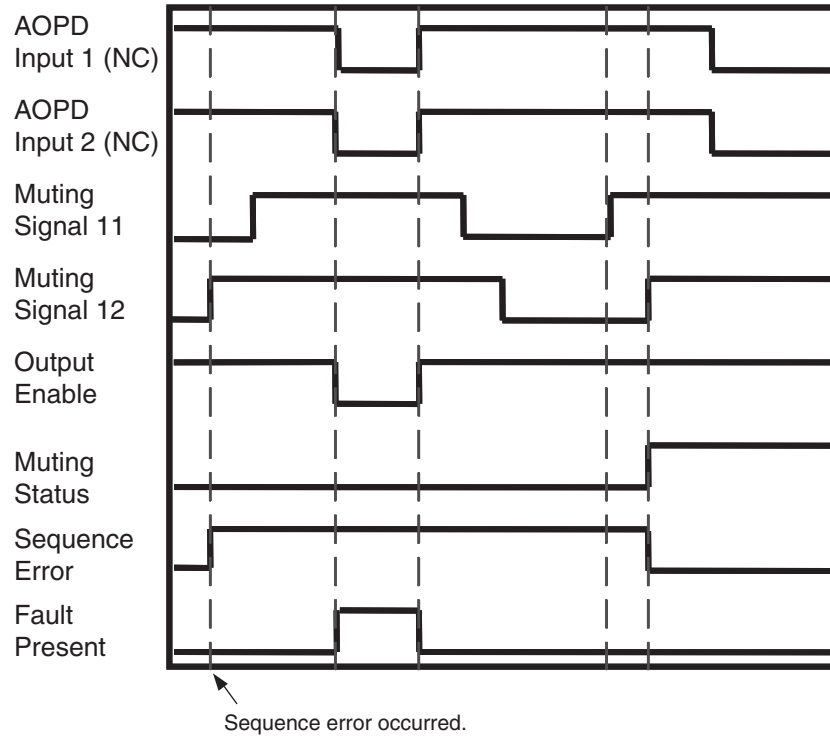

■ Sequential Muting (Forward Direction)

In this example, four Through-beam Photoelectric Sensors are set up as the sensors with intersecting detection zones.

Use this configuration when the length of the workpiece being transported is longer than a fixed length.

Block Diagram

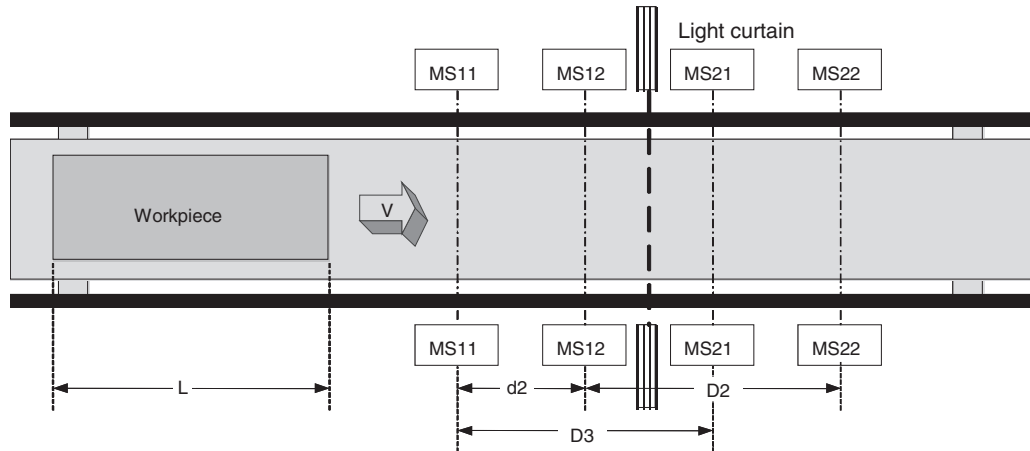

- MS11: Muting sensor connected to Muting Signal 11
- MS12: Muting sensor connected to Muting Signal 12
- MS21: Muting sensor connected to Muting Signal 21
- MS22: Muting sensor connected to Muting Signal 22

Muting Sequence

1. In the block diagram above, the light is not interrupted between MS11, MS12, MS21, and MS22 and the light curtain, so the Output Enable signal is ON.
2. As the workpiece moves to the right and MS11 and MS12 go ON in order, muting is enabled, and the Muting Status goes ON.
3. As the workpiece continues advancing, the Output Enable signal is kept ON even if the light curtain is obstructed.
4. As the workpiece continues advancing, light from MS21 is no longer interrupted by the workpiece, the muting status is cleared, and the Muting Status goes OFF.

Setup Distances

The following formulae show the minimum distances of D2 and D3 required for the muting sensors to provide effective muting function operation:

Formula 3: $D2 < L$

Formula 4: $D3 < L$

L: Length of the workpiece

The following formula shows the maximum distance of d2 required for the muting sensors to provide effective muting function operation:

Formula 5: $V \times T1min < d2 < V \times T1max$

V: Transit speed of the workpiece

T1min: NE1A-series Controller cycle time

T1max: Synchronization time setting time

The default setting is 3 s.

D2 must satisfy formula 3, D3 must satisfy formula 4, and d5 must satisfy formula 5 in order for the muting function to operate effectively. These distance settings must prevent a passing person from enabling the muting function. Also, the light curtain and muting sensors must be setup so that a workpiece passes by all of the muting sensors before the next workpiece arrives at the muting sensors.

■ **Timing Chart**

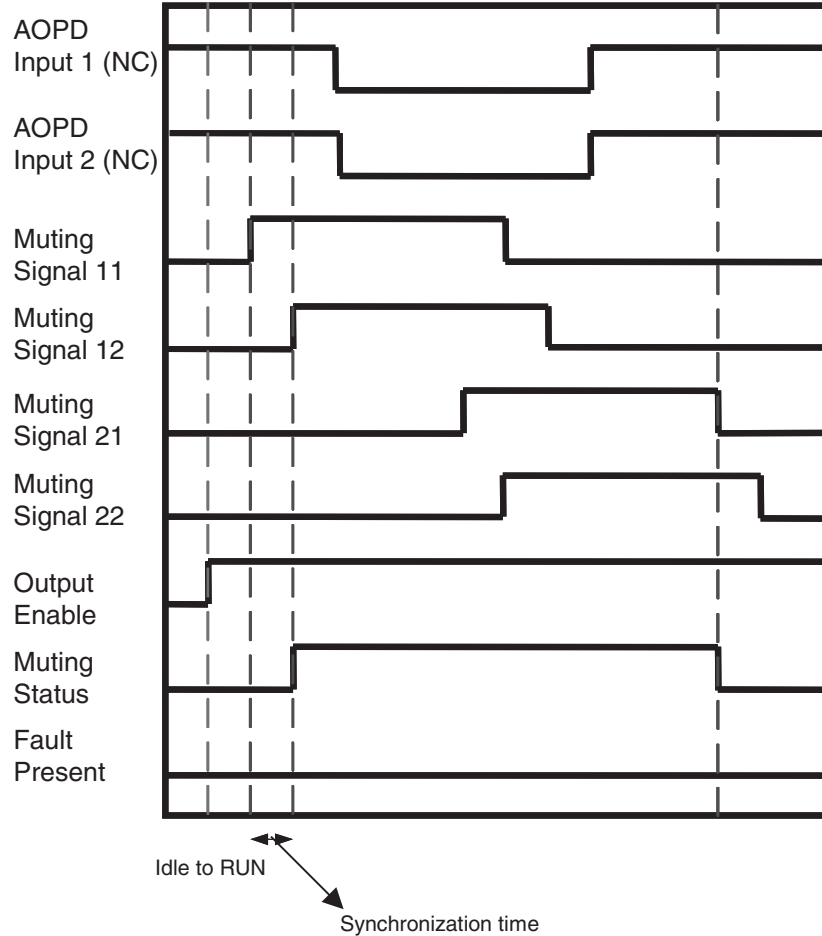

■ Sequential Muting (Both Direction)

Block Diagram

1. Entrance

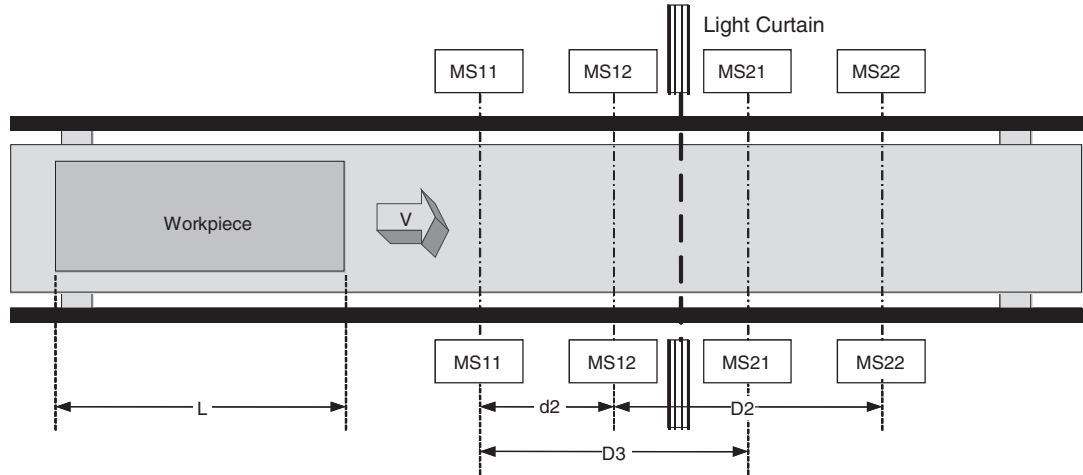

2. Exit

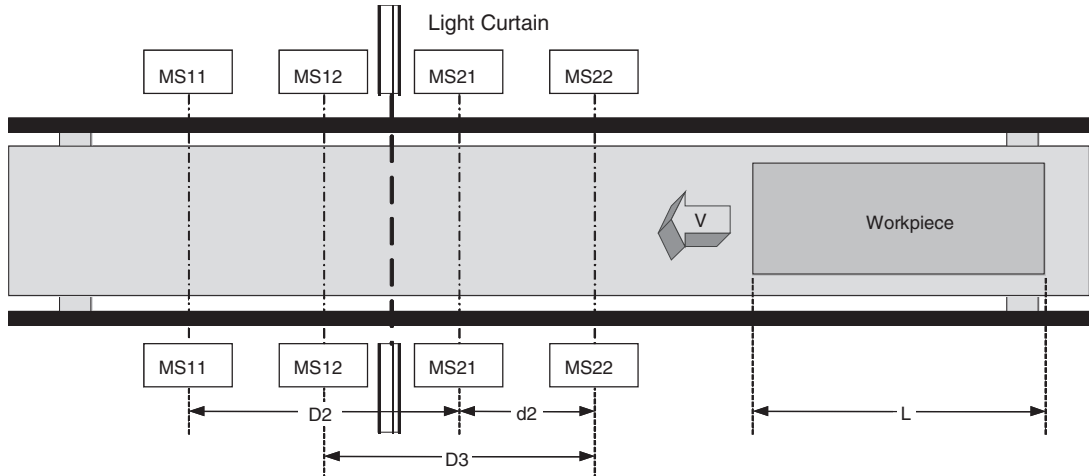

MS11: Muting sensor connected to Muting Signal 11

MS12: Muting sensor connected to Muting Signal 12

MS21: Muting sensor connected to Muting Signal 21

MS22: Muting sensor connected to Muting Signal 22

Muting Sequence

1. In the block diagram above, the light is not interrupted between MS11, MS12, MS21, and MS22 and the light curtain, so the Output Enable signal is ON.
2. For the entrance, as the workpiece moves to the right and MS11 and MS12 go ON in order (MS22 and MS21 go ON in order at the exit), muting is enabled, and the Muting Status goes ON.
3. As the workpiece continues advancing, the Output Enable signal is kept ON even if the light curtain is obstructed.
4. As the workpiece continues advancing, the workpiece is no longer detected by MS21 at the entrance (MS12 at the exit), the muting status is cleared, and the Muting Status goes OFF.

Setup Distances

The setup distance requirements are the same as for *Sequential Muting (Forward Direction)*.

■ **Timing Chart**

Entrance

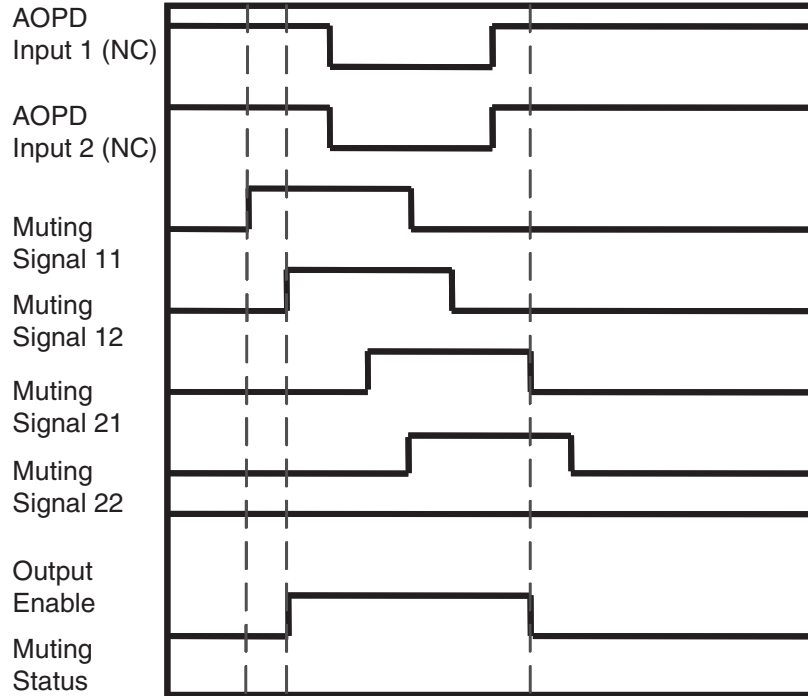

↔
Synchronization time

Time-difference Input Pattern 2: Exit

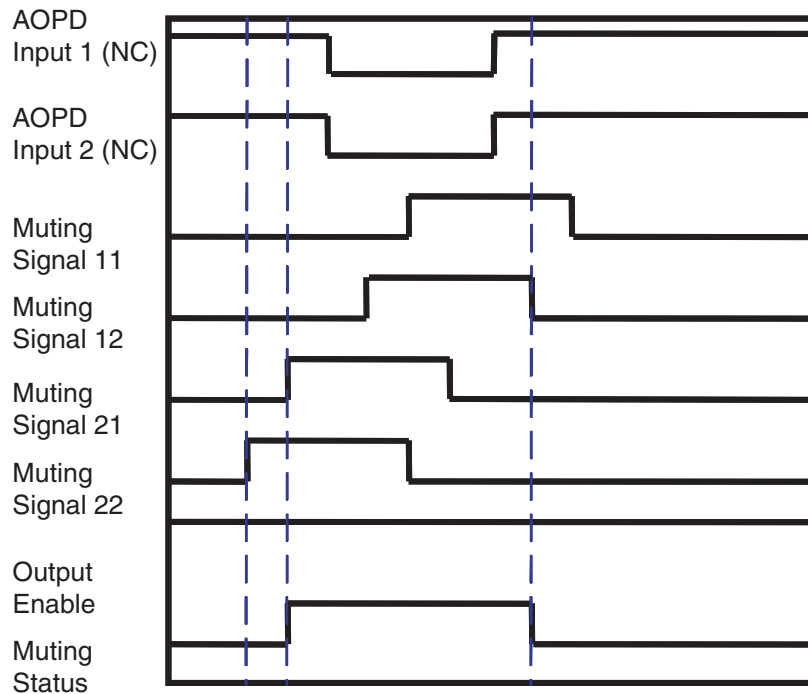

↔
Synchronization time

■ Position Detection

In this application, the workpiece is mounted on a machine turntable surrounded by a guard fence. The operator can disable the light-interruption signal of the light curtain safety function in order to set a workpiece on the turntable when he is on the opposite side of the machine’s dangerous area.

Block Diagram

Machine’s Dangerous Area is on the Operator’s Side (Figure 1):

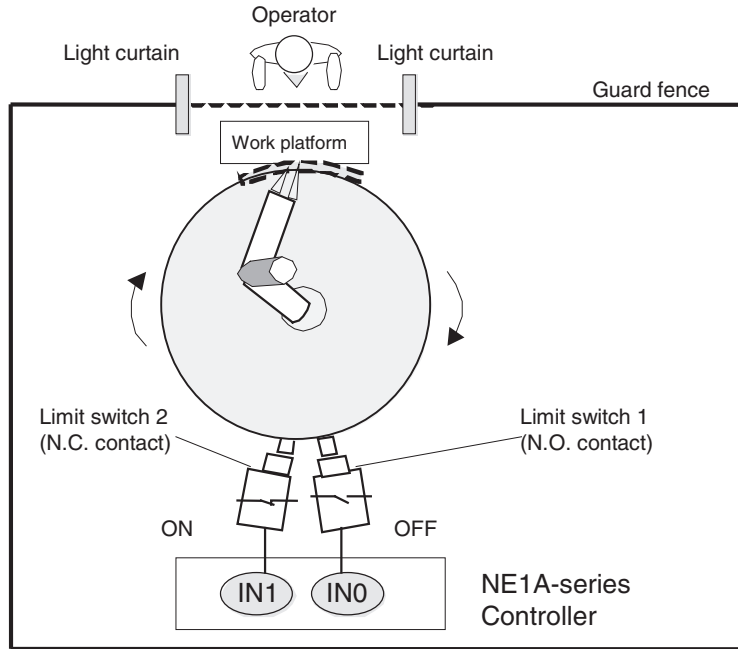

Machine’s Dangerous Area is on the Opposite Side of the Operator (Figure 2):

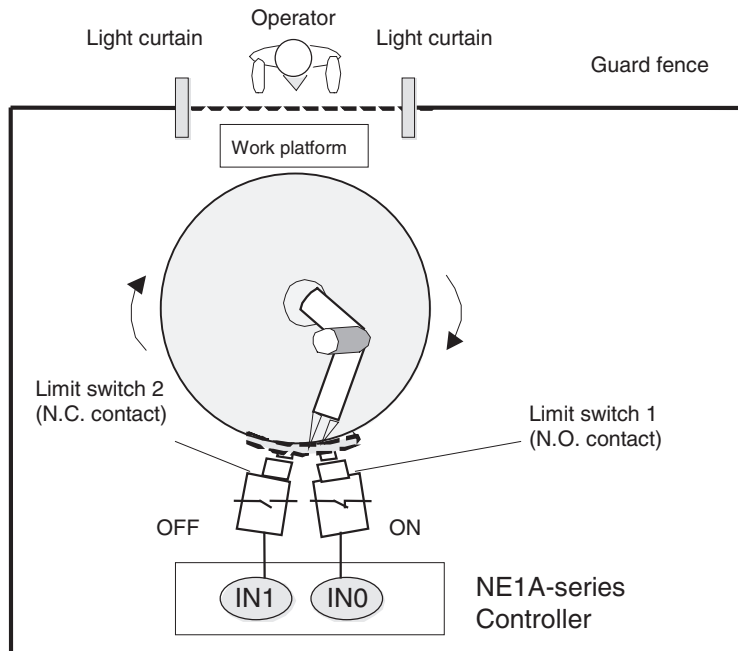

Note In the above example, limit switch 1 is wired to IN0 on the NE1A-series Controller and limit switch 2 is wired to IN1. Set the dual channel mode for local input in the NE1A-series Controller to dual channel complementary.

Program Example

Limit switches 1, 2 connected to IN0, IN1 on the NE1A-series Controller is connected to Muting Signal 11 of the Muting function block.

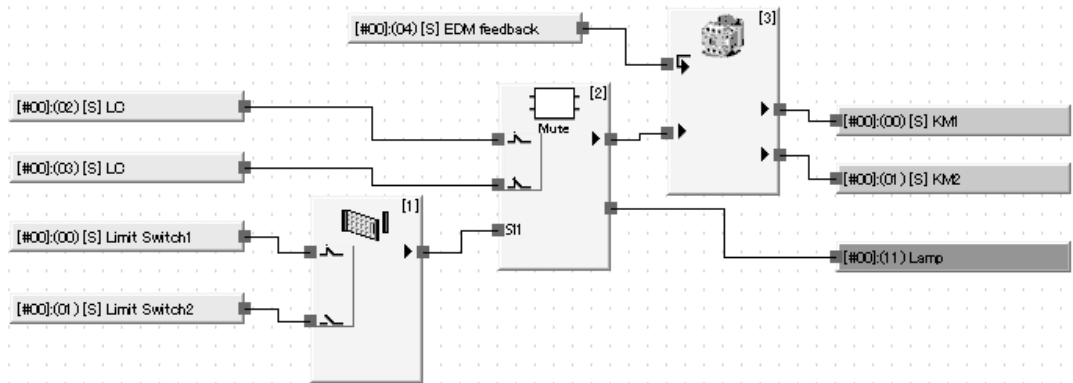

- Note**
- (1) Limit switches 1 and 2 are set to the dual channel complementary setting for local inputs to evaluate the input data from the two switches.
 - (2) The Safety Door Monitoring function block is used as a substitute for the Limit Switch function block. The input type for the Safety Door Monitoring function block is set as Dual Channel Complementary (1 pair).

Muting Sequence

1. In figure 1 above, N.O. limit switch 1 is OFF and N.C. limit switch 2 is ON. In addition, the light curtain is not obstructed, so the Output Enable signal is ON. Muting Signal 11, which inputs the dual channel complementary signal for limit switches 1 and 2, goes OFF.
2. As the robotic arm rotates, limit switch 1 goes ON and limit switch 2 goes OFF as shown in figure 2. Muting Signal 11, which inputs the dual channel complementary signal for limit switches 1 and 2, goes ON, so muting is enabled, and the Muting Status goes ON.
3. At this point, the Output Enable signal is kept ON even if the light curtain is obstructed so the operator can access the work platform.
4. When the operator completes his task and the light curtain is unobstructed as the robotic arm rotates, Muting Signal 11 goes OFF, the muting status is cleared, and the Muting Status goes OFF.

■ Timing Chart

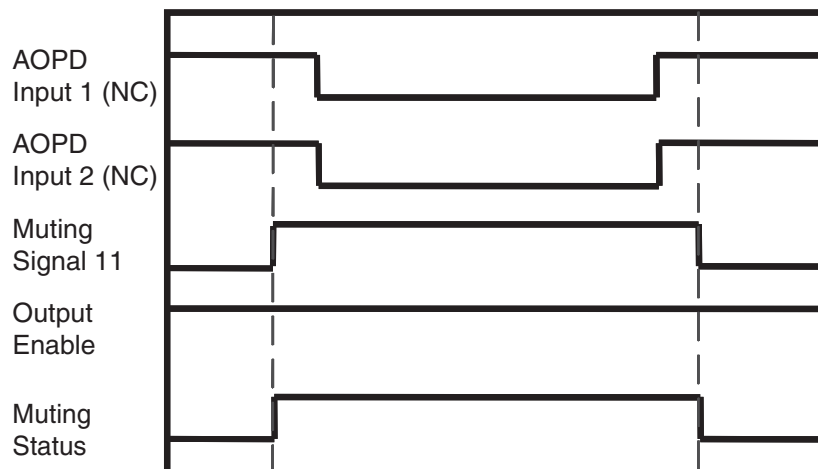

Override Function

The Override function can turn ON the safety output ON even though the light-interruption signal of the light curtain is inactive. If a workpiece gets jammed during transit as shown in the following diagram, the system cannot be returned to normal operation without forcibly removing the workpiece. In a situation like this, the Override function can be used to move the workpiece out of the light curtain detection zone.

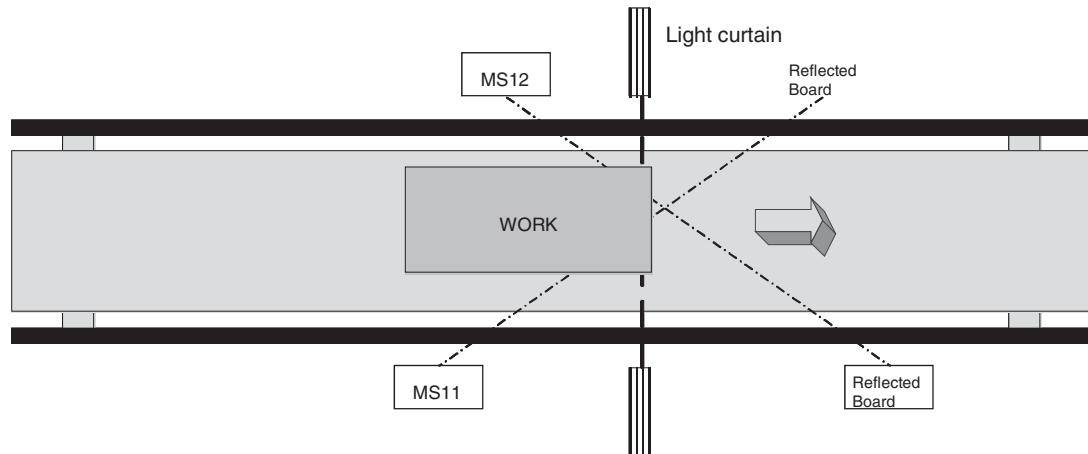

MS11: Muting sensor connected to Muting Signal 11

MS12: Muting sensor connected to Muting Signal 12

Override Sequence

1. In the block diagram above, the Output Enable signal is OFF.
2. When the Override Input goes ON, the Override function starts and the Override Status goes ON. As long as the Override inputs are ON, the muting status is forcibly enabled, and both the Muting Status and Output Enable signals are ON.
3. When the workpiece moves to the right until it is no longer detected by the MS12, the muting status forced by the Override function will be cleared, and both the Muting Status and Override Status will go OFF.

■ **Timing Chart**

Normal Operation of the Override Function (Muting Mode: Parallel Muting with 2 Sensors)

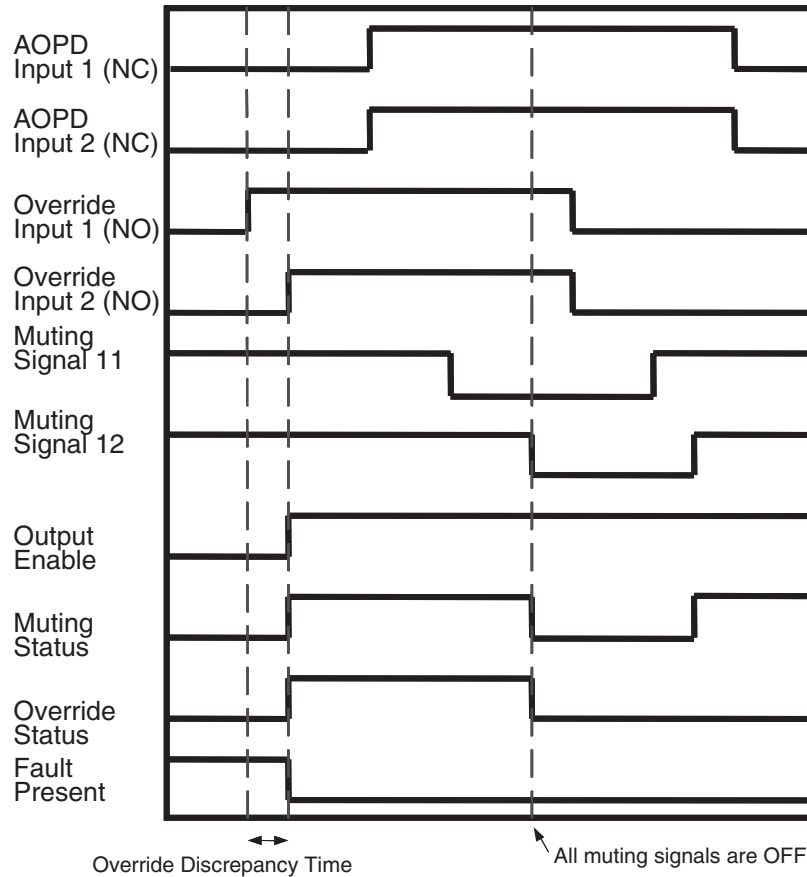

8-5-13 Enable Switch Monitoring (Enable Switch) Unit Ver. 1.0 or Later

Diagram

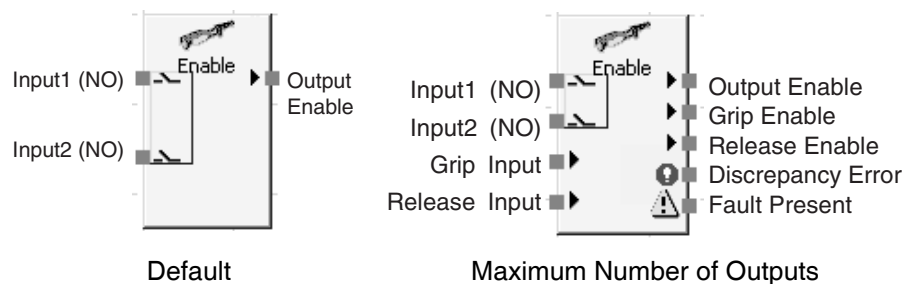

General Description

This function can be used with unit version 1.0 or later (including Controllers that support EtherNet/IP).

The Enable Switch function block monitors the status of the enable-switch device.

The Output Enable signal is ON when the input from the monitored enable-switch device is active. The Output Enable signal is OFF when the input is not active or an error is detected in the function block.

In addition, if the enable-switch device is the type that outputs a grip signal and release signal, the device's Grip Input and Release Input signal status can be monitored. The received Grip Input and Release Input signals do not affect the status of the Output Enable signal.

Set Parameters

Parameter	Setting range	Default setting
Input Type	Single Channel Dual Channel Equivalent	Dual Channel Equivalent
Discrepancy Time	0 to 30 s in 10-ms increments A discrepancy time check will not be performed if 0 is set.	30 ms

The timer SV must be longer than the NE1A-series Controller's cycle time.

Number of I/O Points Setting

The Grip Input and Release Input can be enabled and disabled on the In/Out Setting Tab Page in the function block property dialog box.

Parameter	Setting range	Default setting
Number of inputs	2 to 4 (Optional Input Settings) 2: Grip and Release Inputs disabled. 3: Grip Input enabled. 4: Relate Input enabled.	2

Optional Output Setting

The following outputs can also be used in programming. To enable any of these optional outputs, select the corresponding checkbox on the Out Point Tab Page of the function block properties dialog box.

- Grip Enable
- Release Enable
- Discrepancy Error

Fault Present Output Setting

A Fault Present output can also be used in programming.

To enable this output, select the Fault Present checkbox on the Out Point Tab Page of the function block properties dialog box.

Error Handling and Error Resetting

Error condition	Behavior for error detection			Resetting the error condition
	Output Enable	Fault Present	Error output	
Discrepancy Error	OFF (safety state)	ON	Discrepancy Error: ON	Remove the cause of the error and then do one of the following: 1. Make the input inactive and then active again. 2. Change the NE1A-series Controller's operating mode to IDLE Mode and then back to RUN Mode.

Timing Charts

Normal Operation and Discrepancy Error:

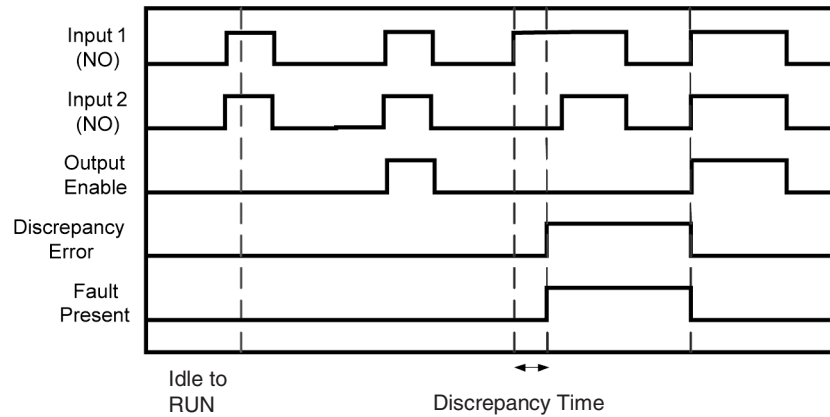

Grip Signal and Release Signal:

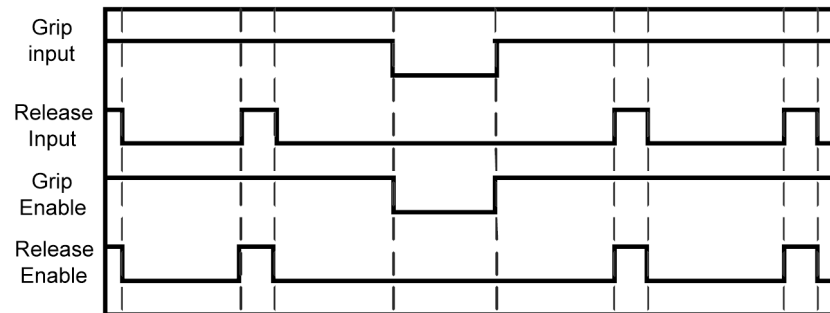

8-5-14 Pulse Generator **Unit Ver. 1.0 or Later**

Diagram

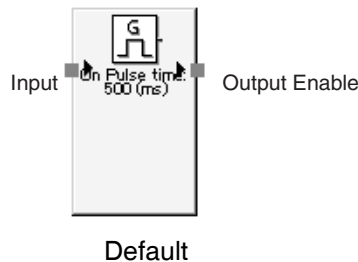

General Description

This function can be used with Controllers with unit version 1.0 or later (including Controllers that support EtherNet/IP).

The Pulse Generator function block generates an ON/OFF pulse output at the Output Enable signal while the function block's Input signal is ON.

The pulse's ON time and OFF time can be set independently between 10 ms and 3 s, in 10-ms increments. When the ON time is set to 100 ms and the OFF time is set to 500 ms, the signal will repeatedly be turned ON for 100 ms and then OFF for 500 ms.

Note The output pulse width will have an error equivalent to the cycle time. For example, if the cycle time is 7 ms and the pulse width is set to 100 ms, the output pulse will be from 93 to 107 ms.

Set Parameters

Parameter	Setting range	Default setting
On Pulse Time	10 ms to 3 s in 10-ms increments	500 ms
Off Pulse Time	10 ms to 3 s in 10-ms increments	500 ms

The timer SV must be longer than the NE1A-series Controller's cycle time.

Timing Chart

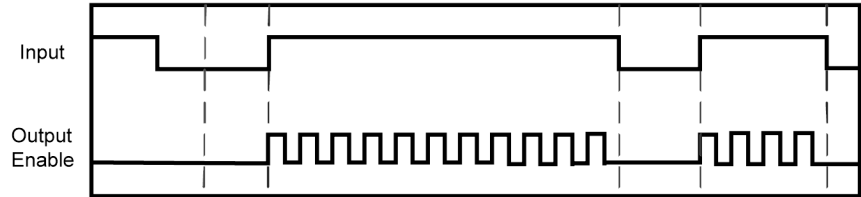

Idle to RUN

8-5-15 Counter **Unit Ver. 1.0 or Later**

Diagram

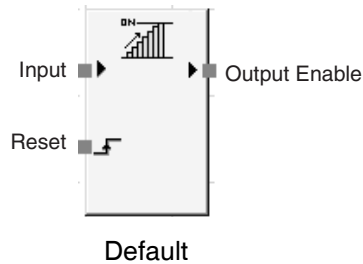

General Description

This function can be used with Controllers with unit version 1.0 or later (including Controllers that support EtherNet/IP).

The Counter function block counts the input pulses at Input and turns ON the Output Enable signal when the count reaches a set value (SV) set with the Network Configurator. The function counts the number of OFF-to-ON transitions in the input signal.

To detect pulses in the input signal, the input pulse's OFF time and ON time must be longer than the cycle time.

■ Counting Methods (Count Type)

The Count Type can be set to Down counter or Up counter (decrementing or incrementing counter).

With a Down (decrementing) counter, the preset SV is the counter's initial value and the counter decrements the count by 1 each time that an input pulse is detected. The Output Enable signal is turned ON when the count reaches 0.

With an Up (incrementing) counter, the counter's initial value is 0 and the counter increments the count by 1 each time that an input pulse is detected. The Output Enable signal is turned ON when the count reaches the preset SV.

The count value (present value) is saved in the function block work area and can be monitored from the Network Configurator.

■ Reset Methods (Reset Condition)

The Reset Condition used to reset the input count (PV) can be set to Manual Reset or Auto Reset.

When the reset condition is set to Auto Reset and the input count reaches the SV, the Output Enable signal is turned ON and remains ON as long as the input signal is ON. When the input signal goes OFF, the input count is reset.

When the reset condition is set to Manual Reset, the input count is reset and the Output Enable signal is turned OFF when the Reset signal goes ON. Input pulses will not be counted while the Reset signal is ON. Counting will be continued when the Reset signals turns OFF.

Set Parameters

Parameter	Setting range	Default setting
Reset Condition	Auto Reset Manual Reset	Manual Reset
Count Type	Down counter (decrementing counter) Up counter (incrementing counter)	Down counter (decrementing counter)
Counter	1 to 65,535 (count)	1 (count)

Timing Charts

1. Auto Reset

Incrementing counter:

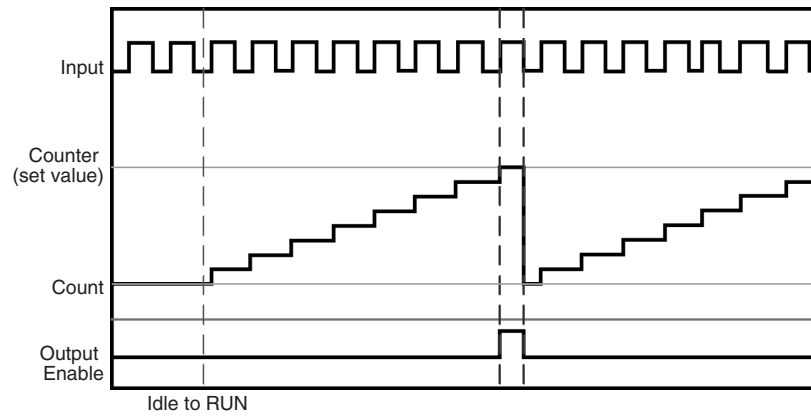

Decrementing counter:

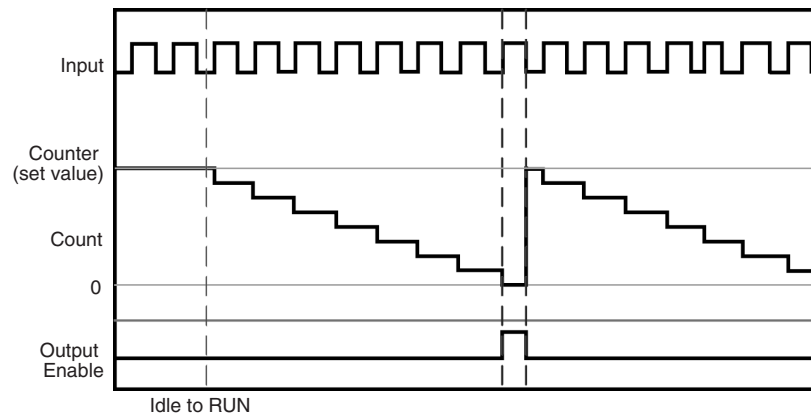

2. Manual Reset

Decrementing counter:

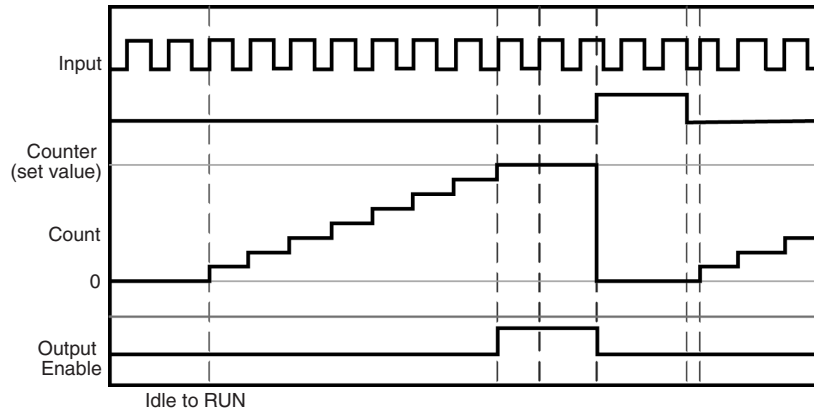

Decrementing counter:

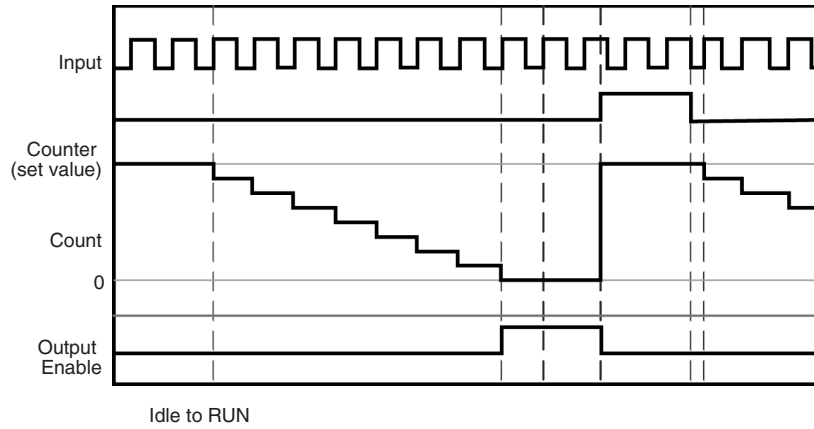

8-5-16 Multi Connector **Unit Ver. 1.0 or Later**

Diagram

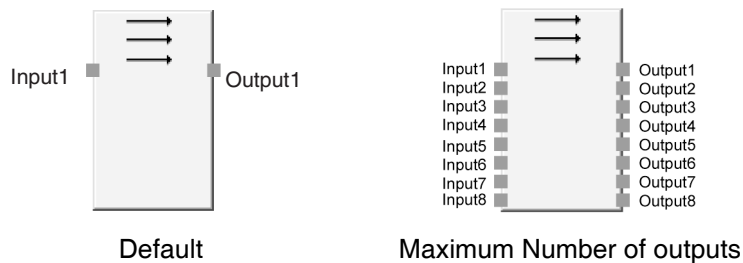

General Description

This function can be used with Controllers with unit version 1.0 or later (including Controllers that support EtherNet/IP).

The Multi Connector function outputs input signals (up to 8 inputs) to output signals (up to 8 outputs).

The input signals and output signals are associated one-to-one from number 1 to 8. The status of other input signals has no effect.

Optional Output Settings

The number of outputs can be increased on the In/Out Setting Tab Page in the function block property dialog box.

Parameter	Setting range	Default setting
Number of inputs	1 to 8	1

Truth Tables

■ **Multi Connector Truth Table:**

Input								Output							
1	2	3	4	5	6	7	8	1	2	3	4	5	6	7	8
0	x	x	x	x	x	x	x	0	x	x	x	x	x	x	x
1	x	x	x	x	x	x	x	1	x	x	x	x	x	x	x
x	0	x	x	x	x	x	x	x	0	x	x	x	x	x	x
x	1	x	x	x	x	x	x	x	1	x	x	x	x	x	x
x	x	0	x	x	x	x	x	x	x	0	x	x	x	x	x
x	x	1	x	x	x	x	x	x	x	1	x	x	x	x	x
x	x	x	0	x	x	x	x	x	x	x	0	x	x	x	x
x	x	x	1	x	x	x	x	x	x	x	1	x	x	x	x
x	x	x	x	0	x	x	x	x	x	x	x	0	x	x	x
x	x	x	x	1	x	x	x	x	x	x	x	1	x	x	x
x	x	x	x	x	0	x	x	x	x	x	x	x	0	x	x
x	x	x	x	x	1	x	x	x	x	x	x	x	1	x	x
x	x	x	x	x	x	0	x	x	x	x	x	x	x	0	x
x	x	x	x	x	x	1	x	x	x	x	x	x	x	1	x
x	x	x	x	x	x	x	0	x	x	x	x	x	x	x	0
x	x	x	x	x	x	x	1	x	x	x	x	x	x	x	1

0: OFF, 1: ON, x: Either ON or OFF

SECTION 9 Other Functions

9-1	Configuration Lock	216
9-2	Reset	217
9-2-1	Reset Types	217
9-2-2	Reset Type and NE1A-series Controller Status	218
9-3	Access Control with Password	219
9-3-1	Scope of Access Control	219
9-3-2	Lost Password	219

9-1 Configuration Lock

The configuration data saved in the NE1A-series Controller can be locked using the Network Configurator to protect the data after downloading and verifying the configuration data. Once the configuration is locked, the configuration data cannot be changed until it is unlocked.

The following occurs when the configuration lock is set.

- The LOCK LED indicator on the front face of NE1A-series Controller lights yellow. (When unlocked, the indicator will flash yellow.)



- On the Network Configurator, the icon indicating the LOCK status is displayed.

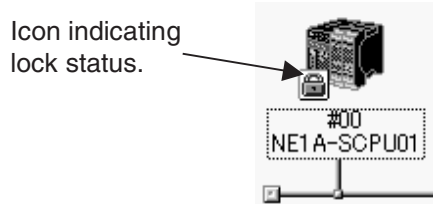

9-2 Reset

9-2-1 Reset Types

The Network Configurator can reset the NE1A-series Controller in the following three ways. A password is required to enter reset.

Reset type	Configuration data	Error history
Emulate cycling power	Settings before the reset are retained.	Log before the reset is retained.
Return to the default configuration, and then emulate cycling power. (Initialize all data.)	Initialization (Default)	Initialized. (All data cleared.)
Return to the default configuration except to preserve the following parameters, and then emulate cycling power. (Retain specified data.)	Depends on user specifications.	Initialized. (All data cleared.)

Configuration data includes device parameters, such as those for DeviceNet communications (Safety/Standard), EtherNet/IP communications settings (for Controllers that support EtherNet/IP), and I/O settings, as well as the user program and passwords.

The NE1A-series Controller stores this data in its nonvolatile memory. Some information, however, cannot be changed once it is set. Select the corresponding reset type to return the information to the default parameter settings.

Depending on the type of reset that is used, however, maintenance data such as the total ON times, contact operation counter monitor settings, or monitor values for the contacts of the local inputs, test outputs, and local outputs will not be cleared.

Refer to *DeviceNet Safety System Configuration Manual* (Cat. No. Z905) for the configurable parameters.

IMPORTANT When a Controller that supports EtherNet/IP is reset to its default settings, the IP address will be cleared and the IP address will then be acquired from the BOOTP server. If you wish to keep the same IP address, then select the *Node Address (Software Set)* Checkbox before resetting the Controller.

9-2-2 Reset Type and NE1A-series Controller Status

Depending on the reset type and NE1A-series Controller's status, reset might not be possible.

Reset type	NE1A-series Controller's status			
	RUN and configuration locked. - MS indicator lit green - LOCK indicator lit	RUN and configuration unlocked. - MS indicator lit green - LOCK indicator flashing	Not RUN, and configuration locked. - MS not lit green - LOCK indicator lit	Not RUN, and configuration unlocked. - MS not lit green - LOCK indicator flashing or OFF
Emulate cycling power	Able to reset	Able to reset	Able to reset	Able to reset
Return to the default configuration, and then emulate cycling power.	Unable to reset	Able to reset	Unable to reset	Able to reset
Return to the default configuration except to preserve the following parameters, and then emulate cycling power.	Unable to reset	Able to reset	Unable to reset	Able to reset

Note Resetting is not possible after a safety I/O connection has been established.

9-3 Access Control with Password

The NE1A-series Controller can register a password in its nonvolatile memory. The password can be used to prevent unexpected or unauthorized access to the Controller from a person other than a user (i.e., a safety manager). No password is set by default; the user needs to register one.

Use the Network Configurator to set or change the password for the NE1A-series Controller. For information on procedures for setting the password using the Network Configurator, refer to *3-6 Device Password Protection* in the *DeviceNet Safety System Configuration Manual* (Cat. No. Z905).

9-3-1 Scope of Access Control

The following operations require the user to enter a password. The NE1A-series Controller does not perform the following operations unless the password matches.

- Downloading configuration data
- Locking or unlocking the configuration
- Executing the NE1A-series Controller reset service
- Changing the operating mode
- Changing the password

9-3-2 Lost Password

Contact OMRON if you lose your password and it has been set for NE1A-series Controller devices.

SECTION 10

Operating Modes and Power Supply Interruptions

10-1	NE1A-series Controller Operating Modes	222
10-1-1	Operating Mode Overview	222
10-1-2	Confirming the Operating Mode	223
10-1-3	Functions Supported in Each Operating Mode.	224
10-1-4	Operating Mode Setting at Startup	225
10-1-5	Operating Mode Changes	225
10-1-6	Program Execution Delay (Unit Version 2.0 or Later or CPU Unit with EtherNet/IP, Unit Version 1.1 or Later)	225
10-2	Behavior for Power Supply Interruptions.	227
10-2-1	Behavior in Voltage Drop	227
10-2-2	Automatic Recovery from Voltage Drops	227

10-1 NE1A-series Controller Operating Modes

10-1-1 Operating Mode Overview

The following modes are supported by the NE1A-series Controller.

SELF-DIAGNOSTIC Mode

The NE1A-series Controller performs self-diagnosis internally. This is required to ensure safety functions.

CONFIGURING Mode

CONFIGURING Mode exists while waiting for the completion of configuration from the Network Configurator. The NE1A-series Controller switches to Configuring Mode when it is not yet configured after initialization has been completed or when there is an error in the configuration data.

IDLE Mode

IDLE Mode exists while waiting for RUN Mode after initialization has been completed.

Non-safety-related control (standard I/O communications, message communications, etc.) is supported.

RUN Mode

Safety control (user program, safety I/O communications, safety I/O refresh control) and non-safety-related control (standard I/O communications, message communications, etc.) are both supported.

ABORT State

The NE1A-series Controller switches to Abort Mode if the Controller's switch setting is changed after the configuration has been completed. The Controller stops all functions except for message communications and puts them in the safety state.

When Controller's switch settings must be changed due to user system changes, reset the Controller to the default settings. Refer to *SECTION 9 Other Functions* for the reset function.

CRITICAL ERROR State

The NE1A-series Controller switches to this state if a critical error occurs. The Controller stops all functions and puts them in the safety state.

10-1-2 Confirming the Operating Mode

Confirming with the MS Indicator

The user can confirm the operating mode using the MS indicator on the front of the NE1A-series Controller.

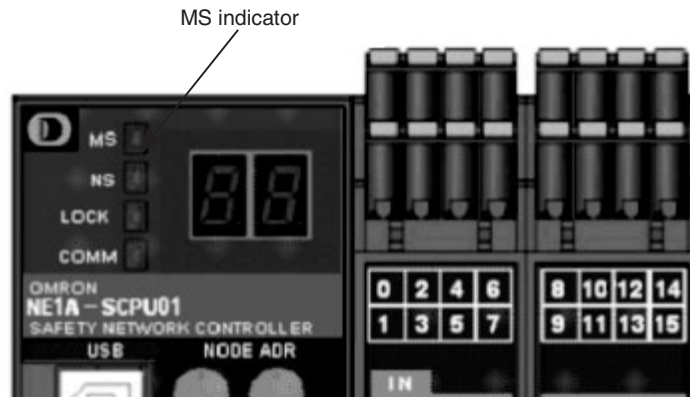

Indicator name	Color	State	Meaning
MS	Green		RUN Mode
			IDLE Mode
	Red		Critical error
			Abort
	Green/red		Self-diagnosis, waiting for TUNID setting, or waiting for configuration.
	-		Power is not supplied.

: ON : Flashing : OFF

Confirming with the Operating Mode Flag

The user can determine whether the NE1A-series Controller's operating mode is RUN Mode or not by checking bit 6 (Operating Mode Flag) of the Unit General Status.

10-1-3 Functions Supported in Each Operating Mode

The following table shows the conditions in each NE1A-series Controller mode and operations supported from the Network Configurator in each mode.

Operating mode	Safety functions			Standard functions		Operations from Network Configurator (See note 1.)				
	User program	Safety I/O communications	Local I/O control (including test outputs)	Standard I/O communications	Message communications	Configuration	Configuration lock/ unlock	Reset	Changing password	Online monitor
RUN	Supported	Supported	Refreshed	Supported	Supported	Supported (See note 3.)	Supported	Supported (See note 4.)	Supported	Supported
IDLE	Stopped	Stopped	Safety State	Supported (See note 2.)	Supported	Supported (See note 3.)	Supported	Supported (See note 4.)	Supported	Supported
CONFIGURING	Stopped	Stopped	Safety State	Stopped	Supported	Supported	Not supported	Supported	Supported	Supported
ABORT	Stopped	Stopped	Safety State	Stopped	Supported	Not supported	Not supported	Supported (See note 4.)	Supported	Supported
CRITICAL ERROR	Stopped	Stopped	Safety State	Stopped	Stopped	Not supported	Not supported	Not supported	Not supported	Not supported
INITIALIZATION	Stopped	Stopped	Safety State	Stopped	Stopped	Not supported	Not supported	Not supported	Not supported	Not supported

- Note**
- (1) A password could be required for operations from the Network Configurator.
For details, refer to *SECTION 9 Other Functions*.
 - (2) When the operating mode of the NE1A-series Controller is changed from RUN to IDLE, input data to the Master depends on the hold setting of the Standard I/O Area. For details, refer to *SECTION 4 DeviceNet Communications Functions* and *SECTION 5 Ethernet Communications*.
 - (3) Depends on the configuration lock setting. For details, refer to *SECTION 9 Other Functions*.
 - (4) Depends on reset types and the configuration lock setting. For details, refer to *SECTION 9 Other Functions*.

10-1-4 Operating Mode Setting at Startup

The user can select the NE1A-series Controller's operating mode from the following two modes at startup, after the normal completion of configuration.

Operating mode on startup	Description
Normal Mode	The NE1A-series Controller starts in IDLE Mode after configuration has been completed. To switch to RUN Mode, use the Network Configurator to change the mode at every startup.
Automatic Execution Mode	When this mode is selected and the following operations are performed, the NE1A-series Controller starts up in RUN Mode thereafter. <ul style="list-style-type: none"> • Configuration lock • Power supply interruptions after switching to RUN Mode.

IMPORTANT When the power supply is interrupted in IDLE Mode, the NE1A-series Controller will not start in RUN Mode at the next startup even though Automatic Execution Mode is set and the configuration is locked. Make sure to turn OFF the power supply in RUN Mode.

10-1-5 Operating Mode Changes

NE1A-series Controller operating modes can be changed using the Network Configurator.

A password may be required to change the operating mode.

- IDLE Mode → RUN Mode
- RUN Mode → IDLE Mode

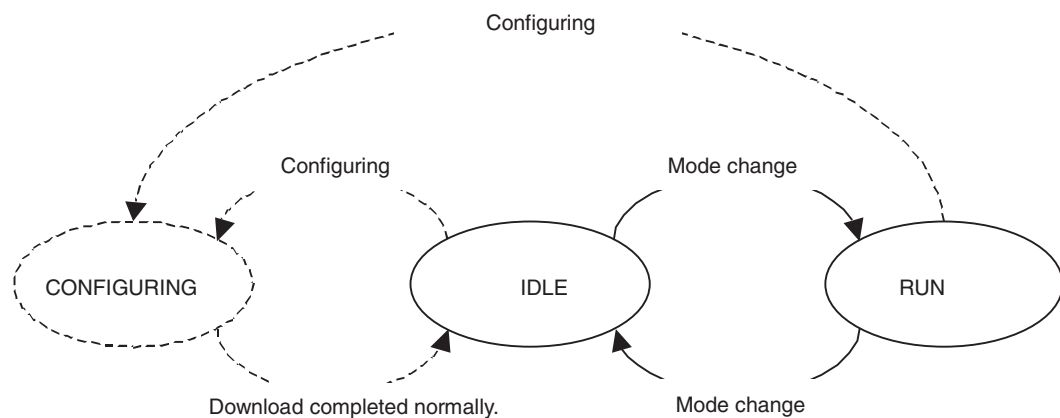

10-1-6 Program Execution Delay (Unit Version 2.0 or Later or CPU Unit with EtherNet/IP, Unit Version 1.1 or Later)

When the NE1A-series Controller starts safety I/O communications in RUN Mode, it must establish safety connections in order with each safety slave that has been registered. Safety I/O communications are thus delayed by a few seconds or tens of seconds over program execution. During this time, safety I/O data will be OFF, possibly causing logic errors if safety I/O data is used for dual-channel complementary inputs to function blocks or the EDM feedback input to an EDM function block.

With unit version 2.0 or later (including Controllers that support EtherNet/IP), program execution can be delayed to help prevent logic errors. If the program execution delay, program execution will be delayed until safety I/O communications have started.

The program execution delay function is enabled on the Extend Mode Tab Page of the Edit Device Parameter Dialog Box.

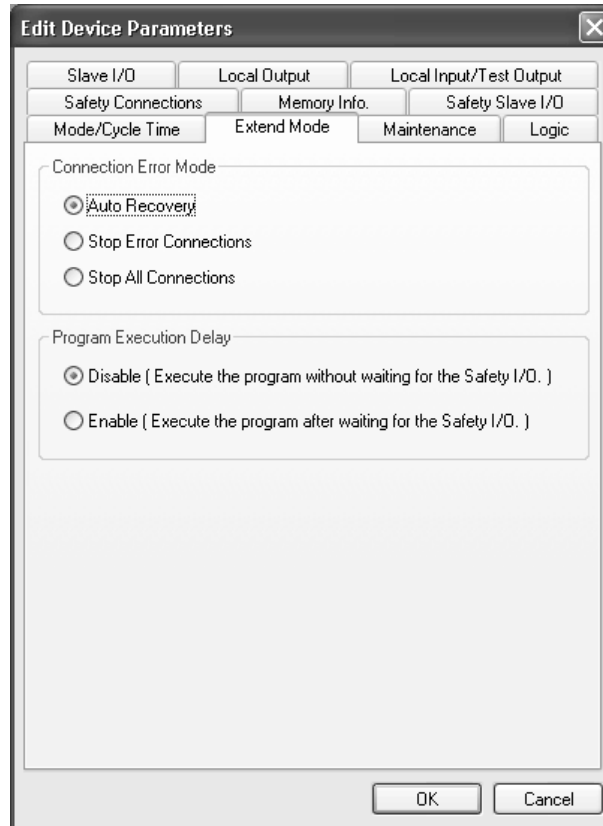

- Note**
- (1) Function block logic errors may still occur even if the program execution delay function is enabled. Test the system before starting actual operation.
 - (2) The maximum program execution delay is 20 seconds. Program execution will start in 20 seconds even if all safety I/O communications have not started normally due to problems in the network, settings, or communications.
 - (3) Program execution will start if there are not changes in connection status for 5 seconds even if safety I/O communications have not started normally.

10-2 Behavior for Power Supply Interruptions

10-2-1 Behavior in Voltage Drop

Low Power Supply Voltage for the Internal Circuits

If the power supply voltage for the internal circuit drops to 85% of the rated voltage or lower, the NE1A-series Controller will turn OFF the outputs.

Low Power Supply Voltage for I/O Circuits

If the power supply voltage for input drops to 85% of the rated voltage or lower when the power supply voltage for the internal circuit is normal, the NE1A-series Controller will continue operation but will stop refreshing inputs. Similarly, if the power supply voltage for output drops to 85% of the rated voltage or lower, the Controller will continue operation but will stop refreshing outputs.

The I/O power supply monitor function of the NE1A-series Controller can be used to monitor the I/O power supply voltage to confirm if it is normal.

10-2-2 Automatic Recovery from Voltage Drops

Power Supply Voltage for the Internal Circuits

If the power supply is recovered (to 85% of the rated voltage or more) because of a fluctuation in the power supply voltage, the following might occur:

1. Operation will automatically restart or
2. A critical error will occur, which will require cycling the power supply to restart operation.

These operations occur because the NE1A-series Controller's operation becomes unstable and it detects a self-diagnosis error. Operation (1) occurs if the power supply to the Controller is completely stopped because the power supply voltage is 85% of the rated voltage or lower, and operation (2) occurs if the power supply fluctuates around the lower operation limit of the internal power/voltage detection circuit.

Power Supply Voltage for the I/O Circuits

I/O refreshing is automatically restarted when the power supply is recovered (to 85% of the rated voltage or more). The I/O power monitor error is also automatically canceled.

SECTION 11

Remote I/O Communications Performance and Local I/O Response Time

11-1	Outline.....	230
11-2	Operational Flow and Cycle Time	231
11-3	Startup Time	232
11-4	I/O Refresh Cycle Time and Network Reaction Time	234
11-5	Reaction Time.....	237
11-5-1	Reaction Time Concepts.....	237
11-5-2	Calculating the Reaction Time	237
11-5-3	Verifying the Reaction Time.....	242

11-1 Outline

The NE1A-series Controller's remote I/O communications performance and local I/O response time are described in this section.

The calculations shown here are assumed to satisfy the following conditions:

- The configuration is correct.
- The power has been turned ON, the NE1A-series Controller's self-diagnostic function has been completed, and the NE1A-series Controller is in RUN Mode.
- The necessary Safety Slaves have been added to the system.

11-2 Operational Flow and Cycle Time

The NE1A-series Controller's operations are outlined here.

The NE1A-series Controller initializes itself internally when the power is turned ON. Unless there are errors, the Controller then cyclically executes system processing, DeviceNet, EtherNet/IP, and USB communications processing, I/O refreshing, and the user program. When DeviceNet communications disable (Standalone) is set, DeviceNet processing is omitted from the cyclic execution.

In Standalone Controller mode, the Controller cyclically executes all but the DeviceNet processes. The cycle time depends on the scale of the user program and the configuration of DeviceNet remote I/O communications.

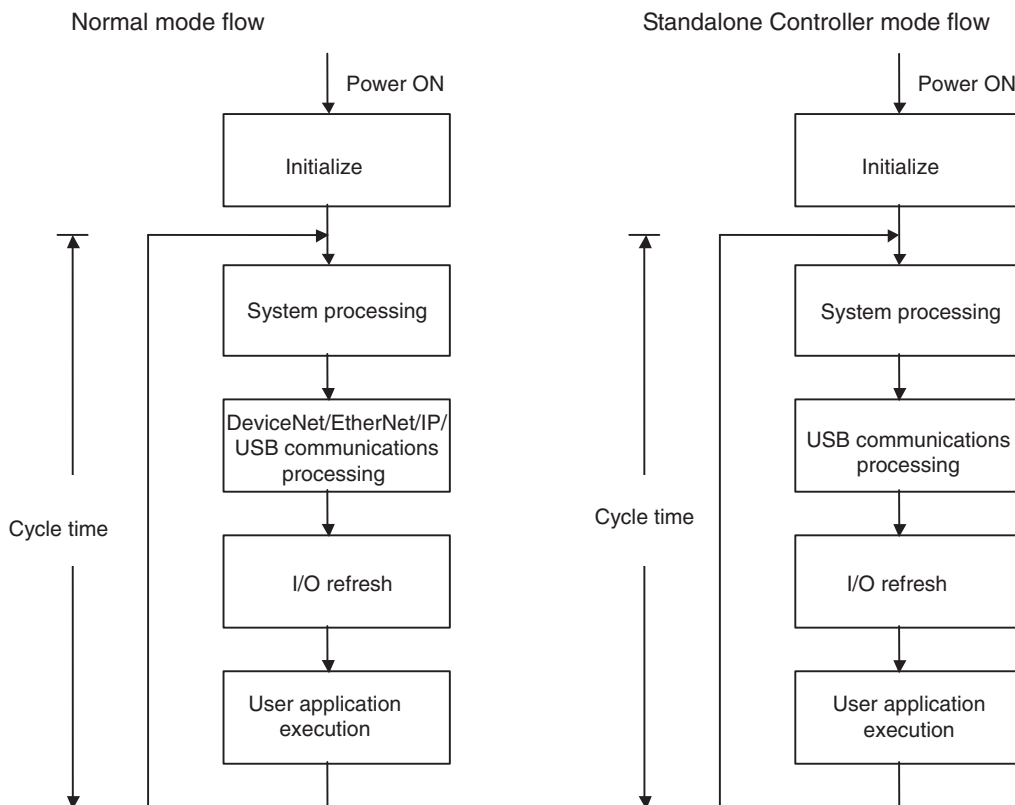

The cycle time is expressed by the following formula.

$$\begin{aligned} \text{NE1A-series Controller cycle time} = & \text{System processing time} \\ & + \text{DeviceNet, EtherNet/IP, or USB communications processing time} \\ & + \text{I/O refresh time} \\ & + \text{User application execution time} \end{aligned}$$

The cycle time of the NE1A-series Controller is set in 1-ms increments according to the configuration. The cycle time can be checked from the Network Configurator, on the Mode/Cycle Time Tab Page of the Edit Device Parameters Window.

IMPORTANT For a Controller that supports EtherNet/IP, the maximum cycle time is 60 ms. If a cycle time of more than 60 ms is set, correct the connection settings and user applications and change the system configuration so that the cycle time will be less than 60 ms.

11-3 Startup Time

Initialization Time

The NE1A-series Controller performs initialization when the power is turned ON. During initialization, the Controller performs self-diagnosis of the hardware that is required to execute safety functions. The following table shows the times required to complete initialization from when the power is turned ON.

Model	Unit version	Initialization time
NE1A-SCPU01	None	6 s
NE1A-SCPU01-V1	1.0	7 s
	2.0	9 s
NE1A-SCPU02	1.0	9 s
	2.0	9 s
NE1A-SCPU01-EIP	1.0/1.1	9 s
NE1A-SCPU02-EIP	1.0/1.1	9 s

Time Until Start of Program Execution Depending on Unit Version

Unit Version 1.0

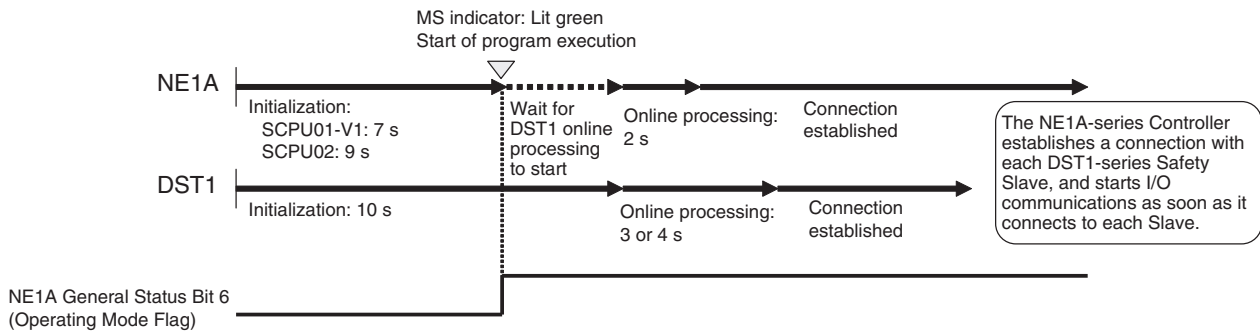

Unit Version 2.0

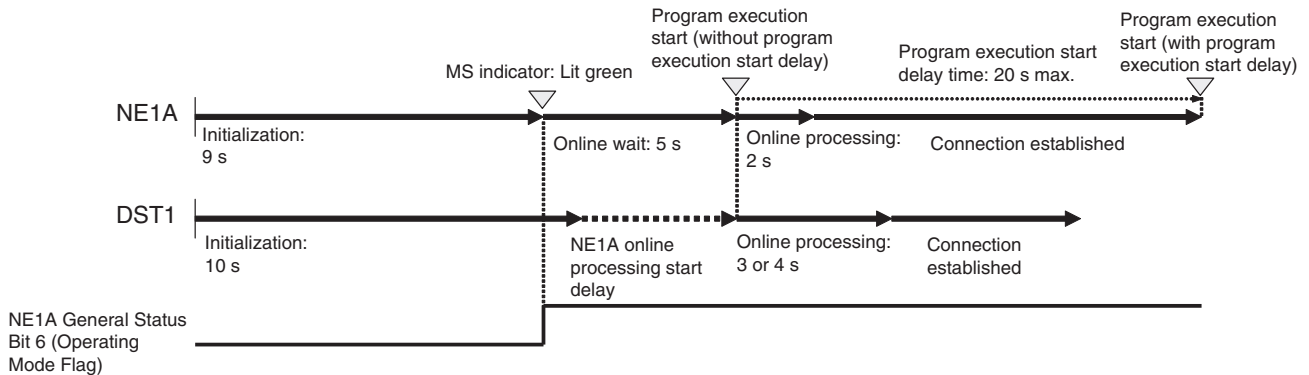

Note

- (1) With NE1A-series Controllers with unit version 2.0 (including Controllers that support EtherNet/IP), an online delay time of 5 s is added after the initialization has been completed to allow time for other devices to start.
- (2) After the initialization has been completed, the NE1A-series Controller checks for duplicated addresses on the DeviceNet network and then joins the network (i.e., goes online). After the Controller connects to the network, the NS indicator lights or flashes green. This processing takes a maximum of 2 s.

- (3) There is no online delay time or online processing time when DeviceNet communications are disabled (i.e., in Standalone Mode).
- (4) When the NE1A-series Controller is set for automatic execution when the power is turned ON, program execution is slower for unit version 2.0 (including Controllers that support EtherNet/IP) than for unit version 1.0. With a program in which a timer is started simultaneous with the start of NE1A-series Controller program execution, the time from when the power is turned ON until the timer times out is extended. Therefore, when changing from unit version 1.0 to 2.0 (including changing a Controller without EtherNet/IP to a Controller with EtherNet/IP), adjust the set value of the timer.

11-4 I/O Refresh Cycle Time and Network Reaction Time

The I/O refresh cycle time and network reaction time parameters are required to evaluate local I/O response and I/O communications performance for the NE1A-series Controller.

I/O Refresh Cycle Time

The I/O reaction time of the NE1A-series Controller is used when calculating the local I/O reaction time. The I/O refresh cycle time is set to the optimum value for the configuration from among the following settings: 3.5, 4.0, 4.5, 5.0, 5.5, 6.0, or 6.5 ms. The I/O refresh cycle time can be checked from the Network Configurator.

The I/O refresh cycle time of the NE1A-series Controller can be checked on the Mode/Cycle Time Tab Page of the Edit Device Parameters Window.

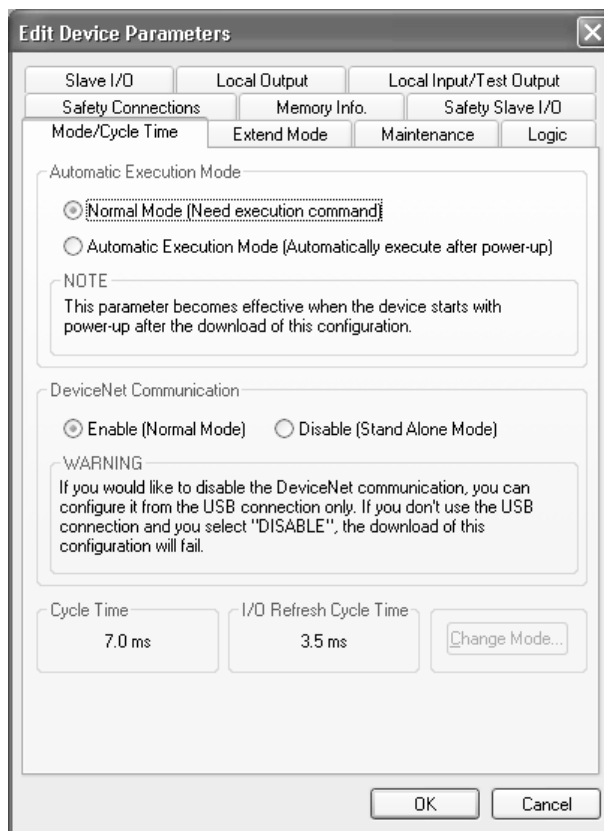

The network reaction time

The network reaction time of the NE1A-series Controller is used when calculating the remote I/O reaction time.

The network reaction time can be checked on the Safety Connections Tab Page of the Edit Device Parameters Window.

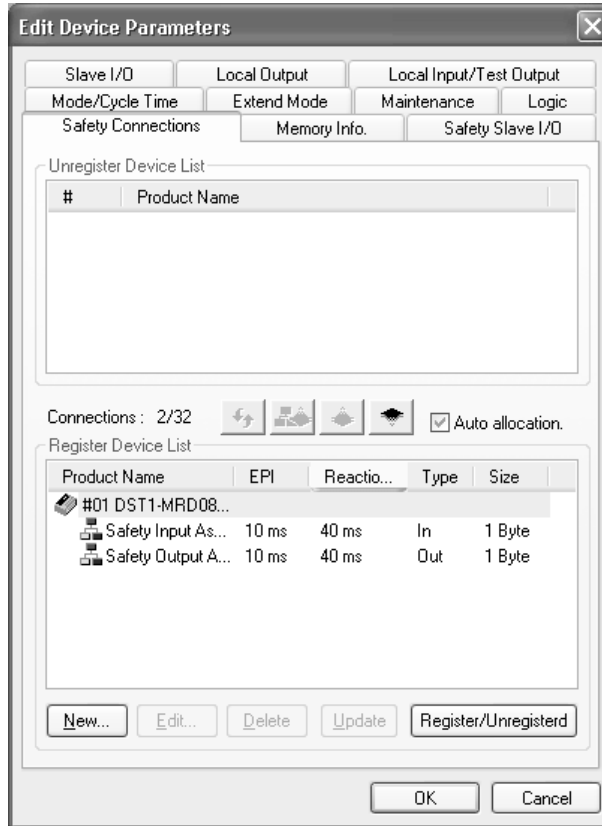

Note The minimum set for the EPI is either the cycle time of the Safety Network Controller or the cycle time of the Safety Slaves (always 6 ms), whichever is greater. The minimum setting for the EPI will therefore be affected if the cycle time of the Safety Network Controller is longer than 6 ms.

Edit Device Parameters

Slave I/O Local Output Local Input/Test Output

Safety Connections Memory Info. Safety Slave I/O

Mode/Cycle Time Extend Mode Maintenance Logic

Automatic Execution Mode

Normal Mode (Need execution command)

Automatic Execution Mode (Automatically execute after power-up)

NOTE

This parameter becomes effective when the device starts with power-up after the download of this configuration.

DeviceNet Communication

Enable (Normal Mode) Disable (Stand Alone Mode)

WARNING

If you would like to disable the DeviceNet communication, you can configure it from the USB connection only. If you don't use the USB connection and you select "DISABLE", the download of this configuration will fail.

Cycle Time: 7.0 ms I/O Refresh Cycle Time: 3.5 ms Change Mode...

OK Cancel

11-5 Reaction Time

11-5-1 Reaction Time Concepts

The reaction time is the time required to stop machine operation in a worst-case scenario considering the occurrence of faults and failures in the safety chain.

The reaction time is used to calculate the safety distance.

The reaction time is calculated for each safety chain. Some typical safety chains are shown below.

1. Local Input - Local Output

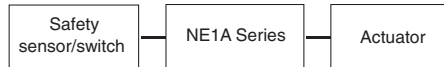

2. Remote Input - Local Output



3. Local Input/Remote Output

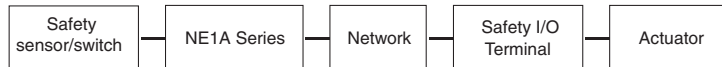

4. Remote Input/Remote Output

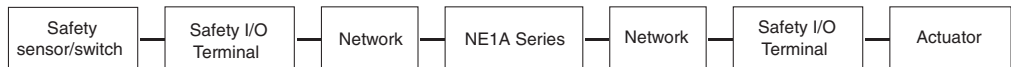

Note There is no I/O response time required in the reaction time when operation is normal. With the reaction time, the output shutoff time will be maintained even if there are faults or failures in devices or the network.

11-5-2 Calculating the Reaction Time

Elements of the Reaction Time

The elements of the reaction time are given below for each safety chain.

1. Local Input – Local Output

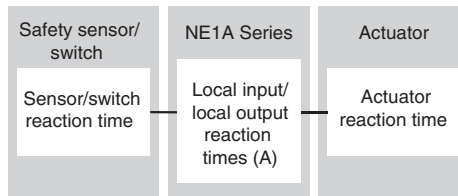

2. Remote Input – Local Output

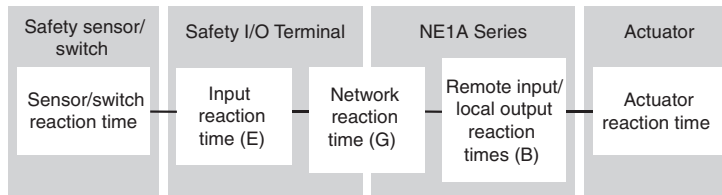

3. Local Input - Remote Output

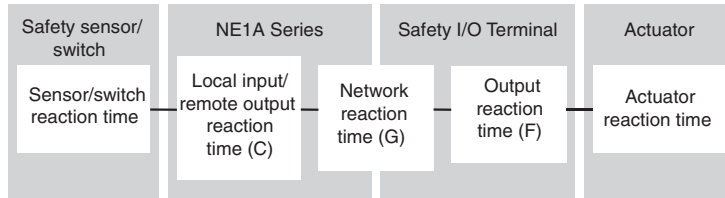

4. Remote Input - Remote Output

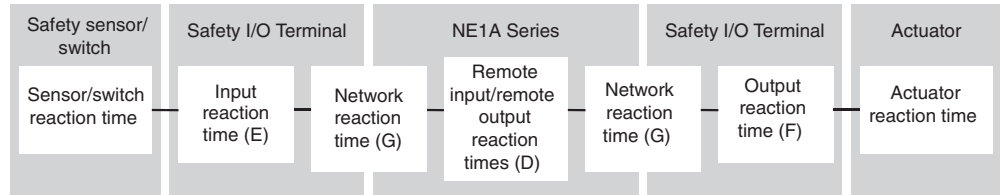

Reaction Time Calculation

	Item	Formula
A	Local input/local output reaction time (ms) at NE1A Series	= ON/OFF delay time + I/O refresh cycle + NE1A Series cycle time × 2 + 2.5
B	Remote input/local output reaction time (ms) at NE1A Series	= NE1A Series cycle time + 2.5
C	Local input/remote output reaction time (ms) at NE1A Series	= ON/OFF delay time + I/O refresh cycle + NE1A Series cycle time × 2
D	Remote input/remote output reaction time (ms) at NE1A Series	= NE1A Series cycle time
E	Input reaction time (ms) at Safety I/O Terminal	= ON/OFF delay time + Input reaction time
F	Output reaction time (ms) at Safety I/O Terminal	= Output reaction time
G	Network reaction time (ms)	= Result of Network Configurator calculation

IMPORTANT If an output from a function block is fed back to the input side of the same function block, the cycle time of the NE1A-series Controller must be added to the reaction time for the safety chain.

Reaction Time Calculation Examples

■ **Example 1: Local Input – Local Output**

The following example shows calculating the reaction time from a local input to a local output for the NE1A-SCPU01 configuration shown in the illustration.

NE1A-SCPU01 configuration:

- Program: 1 AND (2 inputs)
- Standard Slaves: 2 connections
- Safety Masters: None
- Safety Slaves: None

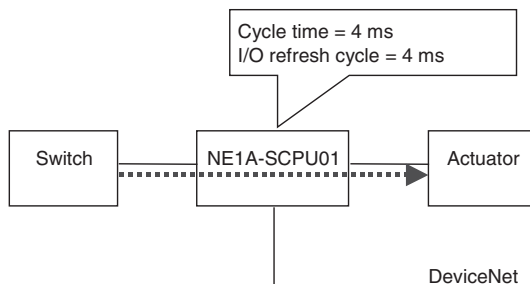

The cycle times read by the Network Configurator will be as follows:

- Controller cycle time = 4 ms
- I/O refresh cycle time = 4 ms

The cycle time of the NE1A-SCPU02 is 6 ms and the I/O refresh time is 6 ms. The reaction time is obtained using the following equation:

$$\begin{aligned}
 \text{Reaction time (ms)} &= \text{Switch reaction time} \\
 &+ \text{NE1A-SCPU01 local input/local output reaction time} \\
 &+ \text{Actuator reaction time} = \text{Switch reaction time} \\
 &+ \text{ON/OFF delay time (NE1A-SCPU01)} + 4 + 4 \times 2 + 2.5 \\
 &+ \text{Actuator reaction time} \\
 &= \mathbf{14.5 + \text{ON/OFF delay time (NE1A-series Controller)}} \\
 &\quad + \text{Switch reaction time} + \text{Actuator reaction time}
 \end{aligned}$$

Note Example 1 above shows the configuration for minimizing reaction time in the NE1A-series Controllers. The guideline for the minimum reaction time is 15 ms for the NE1A-SCPU01(-V1), 21 ms for the NE1A-SCPU02, 20 ms for the NE1A-SCPU01-EIP, and 28 ms for the NE1A-SCPU02-EIP. The Controller cannot be used when a reaction time lower than these values is required from the Controller by the user system.

■ **Example 2: Remote Input – Local Output**

The following example shows calculating the reaction time from a remote input to a local output for the NE1A-SCPU01 configuration shown in the illustration.

NE1A-SCPU01 configuration:

- Program: 1 Safety Gate Monitor, 1 Reset, 1 E-STOP, 1 AND, 1 External Device Monitor
- Standard Slaves: 2 connections
- Safety Master: 1 connection (EPI = 6 ms)
- Safety Slaves: None

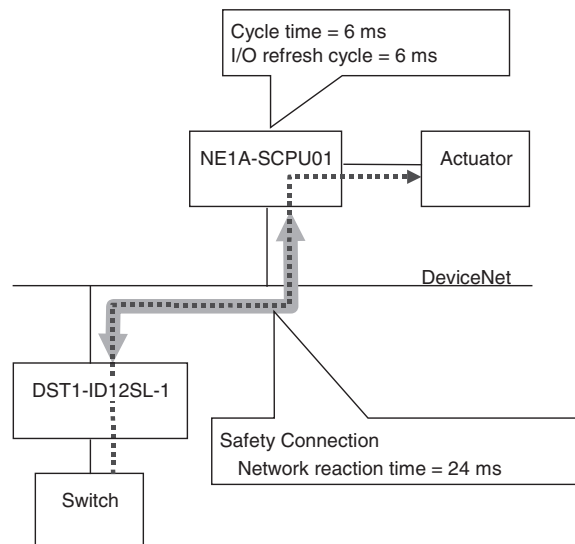

The cycle times read by the Network Configurator will be as follows:

- NE1A-SCPU01 cycle time = 6 ms
- I/O refresh cycle time = 6 ms

The network reaction time will be 24 ms based on a safety connection EPI of 6 ms. The reaction time is obtained using the following equation:

$$\begin{aligned}
 &\text{Reaction time (ms) = Switch reaction time} \\
 &+ \text{Safety I/O Terminal input reaction time} \\
 &+ \text{Network reaction time} \\
 &+ \text{NE1A-SCPU01 remote input/local output reaction time} \\
 &+ \text{Actuator reaction time} \\
 &= \text{Switch reaction time} \\
 &+ \text{ON/OFF delay time (DST1-ID12SL-1) + 16.2} \\
 &(\text{= Input reaction time of DST1-ID12SL-1}) \\
 &\quad + 24 \\
 &\quad + 6 + 2.5 \\
 &\quad + \text{Actuator reaction time} \\
 &= \underline{\underline{48.7 + \text{ON/OFF delay time (DST1-ID12SL-1)}}} \\
 &\quad + \underline{\underline{\text{Switch reaction time + Actuator reaction time}}}
 \end{aligned}$$

■ **Example 3: Local input - Remote output**

The following example shows calculating the reaction time from a local input to a remote output, for the NE1A-SCPU01 node 1 and node 2 configuration shown in the illustration.

NE1A-SCPU01 node 1 (#1) configuration:

- Program: 1 Safety Gate Monitor, 1 Reset, 1 E-STOP, 1 AND, 1 External Device Monitor
- Standard Slaves: 2 connections
- Safety Masters: None
- Safety Slave: 1 connection (EPI = 7 ms)

NE1A-SCPU01 node 2 (#2) configuration:

- Program: 1 Safety Gate Monitor, 1 Reset, 1 E-STOP, 1 AND, 1 External Device Monitor
- Standard Slaves: 2 connections
- Safety Masters: 3 connections (EPI = 7 ms)
- Safety Slaves: None

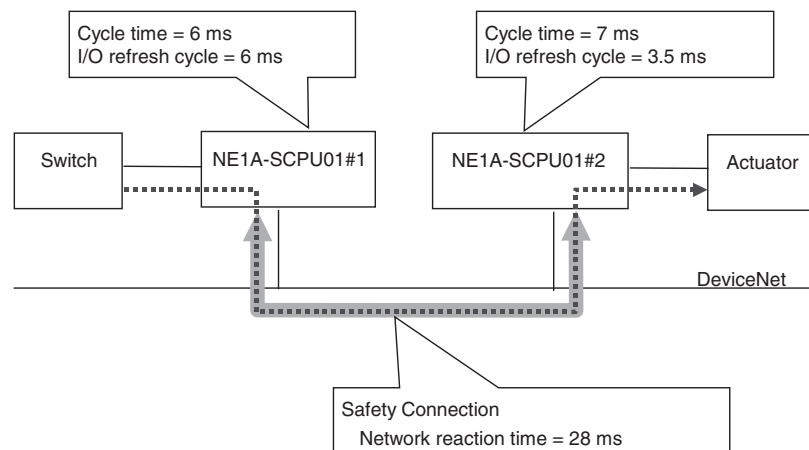

The node 1 (#1) cycle times read by the Network Configurator will be as follows:

- NE1A-SCPU01 cycle time = 6 ms
- I/O refresh cycle time = 6 ms

The node 2 (#2) cycle times will be as follows:

NE1A-SCPU01 cycle time = 7 ms

I/O refresh cycle time = 3.5 ms

The network reaction time will be 28 ms based on a safety connection EPI of 7 ms. The reaction time is obtained using the following equation:

$$\begin{aligned}
 &\text{Reaction time (ms) = Switch reaction time} \\
 &\quad + \text{NE1A-SCPU01 \#1 local input/remote output reaction time} \\
 &\quad + \text{Network reaction time} \\
 &\quad + \text{NE1A-SCPU01 \#2 remote input/local output reaction time} \\
 &\quad + \text{Actuator reaction time} \\
 &= \text{Switch reaction time} \\
 &\quad + \text{ON/OFF delay time (NE1A-SCPU01) + 6 + 6} \times 2 \\
 &\quad + 28 \\
 &\quad + 7 + 2.5 \\
 &\quad + \text{Actuator reaction time} \\
 &= \mathbf{55.5 + \text{ON/OFF delay time (NE1A-SCPU01)}} \\
 &\quad \mathbf{+ \text{Switch reaction time + Actuator reaction time}}
 \end{aligned}$$

■ **Example 4: Remote Input - Remote Output**

The following example shows calculating the reaction time from a remote input to a remote output, for the NE1A-SCPU01 configuration shown in the illustration.

NE1A-SCPU01 node configuration:

- Program: 1 Reset, 1 E-STOP, 1 External Device Monitor
- Standard Slaves: 2 connections
- Safety Masters: 3 connections (EPI = 6 ms)
- Safety Slaves: None

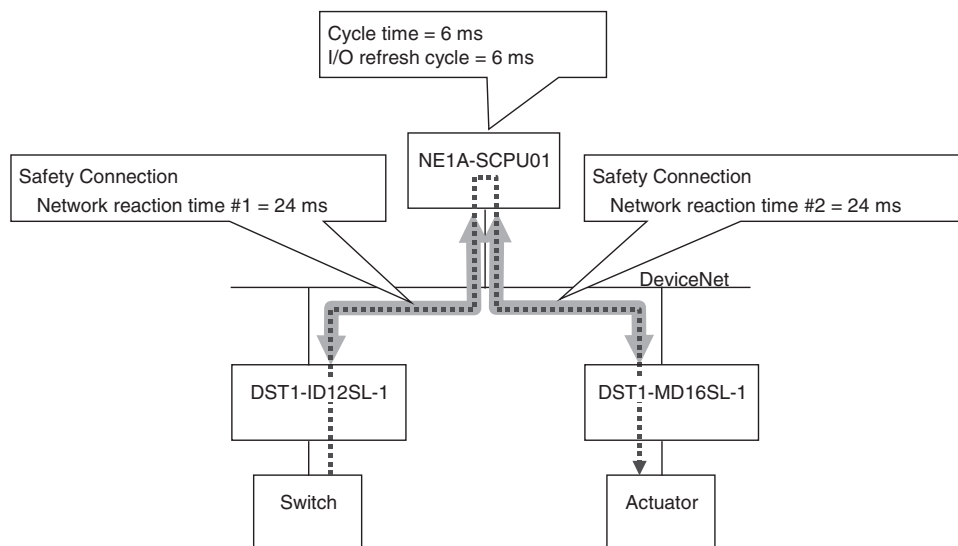

The cycle times read by the Network Configurator will be as follows:

NE1A-SCPU01 cycle time = 6 ms

I/O refresh cycle time = 6 ms

Network reaction times #1 and #2 will be 24 ms each, based on a safety connection EPI of 6 ms. The reaction times are obtained using the following equation:

$$\begin{aligned}
 &\text{Reaction time (ms)} = \text{Switch reaction time} \\
 &\quad + \text{Safety I/O Terminal input reaction time} \\
 &\quad + \text{Network reaction time \#1} \\
 &\quad + \text{NE1A-SCPU01 remote input/remote output reaction time} \\
 &\quad + \text{Network reaction time \#2} \\
 &\quad + \text{Safety I/O Terminal output reaction time} \\
 &\quad + \text{Actuator reaction time \#2} \\
 &= \text{Switch reaction time} \\
 &\quad + \text{ON/OFF delay time (DST1-ID12SL-1)} + 16.2 \\
 &\quad (= \text{Input reaction time of DST1-ID12SL-1}) \\
 &\quad + 24 \\
 &\quad + 6 \\
 &\quad + 24 \\
 &\quad + 6.2 (= \text{Output reaction time of DST1-MD16SL-1}) \\
 &\quad + \text{Actuator reaction time} \\
 &= \underline{\underline{76.4 + \text{ON/OFF delay time (DST1-ID12SL-1)}}} \\
 &\quad + \underline{\underline{\text{Switch reaction time} + \text{Actuator reaction time}}}
 \end{aligned}$$

11-5-3 Verifying the Reaction Time

Always confirm that the reaction time calculated for each safety chain satisfies the required specifications. If the reaction time exceeds the required specifications, consider the following items and correct the design of the network for that reaction time requirements are satisfied.

- The network reaction time can be reduced by shortening the EPI. This, however, will also reduce the network band that can be used for other connections.
- The cycle time of the NE1A-series Controller is automatically calculated based on the size of the program, the number of connections, and other factors. The cycle time can be reduced by using separate NE1A-series Controllers for safety chains that require high-speed reaction times.

WARNING

Serious injury may possibly occur due to loss of required safety functions. Check to make sure that the reaction times calculated for all safety chains meet the required specifications.



SECTION 12

Troubleshooting

12-1	Error Categories	244
12-2	Confirmation of Error State	245
12-3	Indicator/Display Status and Corrective Actions for Errors	246
12-4	Error History	253
12-4-1	Error History Table	253
12-4-2	Error Information Details	256
12-4-3	EtherNet/IP Error History	258
12-5	Errors When Downloading	260
12-5-1	Outline	260
12-5-2	Error Messages and Countermeasures	260
12-6	Errors When Resetting	263
12-6-1	Outline	263
12-6-2	Error Messages and Countermeasures	263
12-7	Errors When Changing Modes	264
12-7-1	Outline	264
12-7-2	Error Messages and Countermeasures	264
12-8	Connection Status Tables	265
12-8-1	Outline	265
12-8-2	Connection Status for DST1 Series	266
12-8-3	Connection Status for the NE1A-series Controller (Safety Slave Function)	268

12-1 Error Categories

NE1A-series Controller errors can be categorized into the following three categories:

Nonfatal Errors

The part where an error has occurred stops at each local I/O or safety I/O connection terminal and places it in the safety state. The Controller, however, continues in RUN Mode.

Abort Errors

The NE1A-series Controller completely stops safety functions and places them in the safety state when this error occurs. To enable checking the error state, explicit message communications or partial Network Configurator functions are supported.

Critical Error

The NE1A-series Controller completely stops its functions when this error occurs.

- Note** Refer to *12-5 Errors When Downloading* for setting errors that occur during configuration.
- Note** Refer to *12-6 Errors When Resetting* for errors that occur when resetting the NE1A-series Controller.
- Note** Refer to *12-7 Errors When Changing Modes* for errors that occur when changing the operating mode of the NE1A-series Controller.



12-2 Confirmation of Error State

Error details can be checked from the following two pieces of information:

- LED indicator status on the front of the NE1A-series Controller
- Reading the NE1A-series Controller's error history using the Network Configurator

12-3 Indicator/Display Status and Corrective Actions for Errors

Critical Errors









Indicators/display			Error history		Cause	Corrective actions
MS	NS	Seven-segment display	Name	Saved in nonvolatile memory		
■ OFF	■ OFF	OFF	None	Not supported	<ul style="list-style-type: none"> Noise level higher than expected. Critical hardware fault 	<p>Cycle the power supply and check operation.</p> <p>If the problem recurs, the NE1A-series Controller may be faulty.</p> <ul style="list-style-type: none"> Check whether there is any influence from noise, and take whatever corrective actions are required.
 Lit red	■ OFF	Left: H Right: ---	System Failure	As much saved as possible.	<ul style="list-style-type: none"> Before operation, the safety output terminal or test output terminal was short-circuited to 24 VDC. Noise impact more than expected. Critical hardware fault 	<ul style="list-style-type: none"> Check the external wiring for power supply short-circuiting at the output terminal. Check whether there is any influence from noise, and take whatever corrective actions are required. Turn the power OFF and back ON and check operation. If the problem recurs, the NE1A-series Controller may be faulty.
 Lit red	■ OFF	P6	System Failure	(See note.)	A safety output terminal or test output terminal shorted to 24-VDC before operation started.	<ul style="list-style-type: none"> Check the external wiring for power supply short-circuiting at the output terminal. Turn the power OFF and back ON and check operation. If the problem recurs, the NE1A-series Controller may be faulty.







Note Not applicable to Pre-Ver. 1.0 Controllers. Applicable to unit version 1.0 or later (including Controllers that support EtherNet/IP).

Abort Errors









Indicators/display			Error history		Cause	Corrective actions
MS	NS	Seven-segment display	Name	Saved in nonvolatile memory		
 Flashing red	---	E8↔ Node address of error	Switch Setting Mismatch	Yes	The node address and baud rate were changed after the normal completion of configuration download.	<ul style="list-style-type: none"> • Configure the switches properly. • Reset the configuration data.

Nonfatal Errors

Indicators/display			Error history		Cause	Corrective actions
NS	Seven-segment display	I/O	Name	Saved in nonvolatile memory		
 Lit red	F0↔ Node address of error	---	Duplicate MAC ID	See note 1.	Node address duplication (Same node address set for more than one node.)	<ul style="list-style-type: none"> • Check the node addresses of other nodes. • Switch ON the power supply again after reconfiguring without duplication.
 Lit red	F1↔ Node address of error	---	Bus Off	See note 1.	Bus Off (Communications cut off because of frequent data errors.)	<ul style="list-style-type: none"> • Check the following points and take corrective actions for each, then turn ON the power supply. • Make sure the baud rate is the same for all nodes. • Make sure the cable lengths (main/branch) are not too long. • Make sure the cable is not disconnected or loose. • Make sure terminating resistance is at both ends of the main line and only at both ends. • Make sure that there is not a lot of noise.
 Flashing red	L9↔ Master node address	---	Standard I/O Connection Timeout	See note 1.	Standard I/O connection timeout	<ul style="list-style-type: none"> • Check the following points: • Make sure the baud rate is the same for all nodes. • Make sure the cable lengths (main/branch) are not too long. • Make sure the cable is not disconnected or loose. • Make sure terminating resistance is at both ends of the main line and only at both ends. • Make sure that there is not a lot of noise.
 Flashing red	dA↔ Destination slave node address	---	Safety I/O Connection Timeout	See note 1.	Safety I/O connection timeout	
 Flashing red	d5↔ Destination slave node address	---	Nonexistent Slave Device	See note 1.	No slave	
 Flashing red	d6↔ Destination slave node address	---	Safety I/O Connection Establishment Failure	See note 1.	Safety I/O connection establishment error	<ul style="list-style-type: none"> • Check the slave device. • Make sure it is configured. • Make sure it is in a normal operational state.
 Flashing red	d6↔ Destination slave node address	---	Invalid Slave Device	See note 1.	Invalid slave device (verification error)	<ul style="list-style-type: none"> • Verify the slave device (select Device - Parameters - Compare) and connect a suitable slave device.
 OFF	E0↔ Node address of error	---	Network PS Voltage Low	See note 1.	Network power supply voltage low error	<ul style="list-style-type: none"> • Check the following points: • Make sure the power supply voltage is set within the specified range. • Make sure a cable or wire is not disconnected.

Indicators/display			Error history		Cause	Corrective actions
NS	Seven-segment display	I/O	Name	Saved in nonvolatile memory		
---	E2↔ Node address of error	---	Transmission Timeout	See note 1.	Transmission timeout	<p>Check the following points:</p> <ul style="list-style-type: none"> • Make sure the baud rate is the same for all nodes. • Make sure the cable lengths (main/branch) are not too long. • Make sure the cable is not disconnected or loose. • Make sure terminating resistance is at both ends of the main line and only at both ends. • Make sure that there is not a lot of noise.
	A0↔ Node address of error	---	Relevant Safety I/O communication stopped	Yes (See note 2.)	A safety I/O connection timed out, interrupting the relevant I/O connection.	<p>Check the following points:</p> <ul style="list-style-type: none"> • Make sure the baud rate is the same for all nodes. • Make sure the cable lengths (main/branch) are not too long. • Make sure the cable is not disconnected or loose. • Make sure terminating resistance is at both ends of the main line and only at both ends. • Make sure that there is not a lot of noise.
	A1↔ Node address of error	---	All Safety I/O communication stopped	Yes (See note 2.)	A safety I/O connection timed out, interrupting the relevant I/O connection.	
---	P1↔ Node address of error	Target terminal  lit red Paired terminal (Dual Setting)  flashing red	External Test Signal Failure at Safety Input	See note 1.	External wiring error in safety input.	<p>Check the following points:</p> <ul style="list-style-type: none"> • Make sure the input signal wire is not contacting the power source (positive side). • Make sure the input signal wire does not have an earth fault. • Make sure the input signal wire is not disconnected. • Make sure there is not a short circuit between input signal wires. • Make sure there is no failure in the connected devices. • Make sure the Discrepancy Time setting values are valid. <p>To recover from the above error state, the following conditions are required.</p> <p>Latch input error time must have passed and the root cause must have been removed.</p> <p>The target safety input terminal inputs must turn OFF.</p> <p>To change the discrepancy time, reconfiguration is required.</p>
---	P1↔ Node address of error	Target terminal (Dual Setting)  lit red	Discrepancy Error at Safety Input	See note 1.	Discrepancy error between 2 inputs at safety input.	
---	P1↔ Node address of error	Target terminal  lit red Paired terminal (Dual Setting)  flashing red	Internal Input Failure at Safety Input	See note 1.	Internal circuit failure at safety input.	

Indicators/display			Error history		Cause	Corrective actions
NS	Seven-segment display	I/O	Name	Saved in nonvolatile memory		
---	P2↔ Node address of error	No LED indicator	Overload Detected at Test Output	See note 1.	Overloading was detected at test output (when a test output terminal was set as a standard signal output).	Check whether the output signal wire has an earth fault or is over loaded.
---	P2↔ Node address of error	No LED indicator	Stuck-at-high Detected at Test Output	See note 1.	Stuck-on-high at test output (when a test output terminal was set as a standard signal output).	For the wires, check if the power supply source (positive side) is contacting the output signal wire. After the latch input error time has passed, turn OFF the input after the cause of the error has been removed. The error will be reset. If there is no fault with the wires, replace the unit.
--	P2↔ Node address of error	No LED indicator	Under Current Detected Using Muting Lamp	See note 1.	Disconnection of indicator light was detected at test output (when Terminal T3 is set as the muting lamp signal output)	Check whether the output signal wire is disconnected. If there is no error, check the indicator light.

Indicators/display			Error history		Cause	Corrective actions
NS	Seven-segment display	I/O	Name	Saved in nonvolatile memory		
---	P3↔ Node address of error	Target terminal  lit red Paired terminal (Dual Setting)  flashing red	Over Current Detected at Safety Output	See note 1.	Overcurrent was detected at safety output.	Check the following points: <ul style="list-style-type: none"> • Make sure there is no overcurrent for the output. • Make sure the output signal wire does not have an earth fault. • Make sure the output signal wire is not contacting the power source (positive side). • Make sure there is not a short circuit between output signal wires.
---	P3↔ Node address of error	Target terminal  lit red Paired terminal (Dual Setting)  flashing red	Short Circuit Detected at Safety Output	See note 1.	Short circuit was detected at safety output.	To recover from these errors, the following conditions are required: Latch input error time must have passed, and the root cause must have been removed. The output signal from the user application for the target safety output must turn OFF.
---	P3↔ Node address of error	Target terminal  lit red Paired terminal (Dual Setting)  flashing red	Stuck-at-high Detected at Safety Output	See note 1.	Stuck-on-high at safety output	
---	P3↔ Node address of error	Target terminal  lit red Paired terminal (Dual Setting)  flashing red	Cross Connection Detected at Safety Output	See note 1.	Short circuit was detected between output signal wires at safety output	
---	P3↔ Node address of error	Target terminal (Dual Setting)  lit red	Dual Channel Violation at Safety Output	See note 1.	Output data error at safety output	Check whether program output data (for two outputs) in the Dual Channel Mode are configured as equivalent channels.

Indicators/display			Error history		Cause	Corrective actions
NS	Seven-segment display	I/O	Name	Saved in nonvolatile memory		
---	P4↔ Node address of error	● All OFF	Input PS Voltage Low	See note 1.	I/O power (input) is not connected although a safety input terminal or test output terminal is used.	Check the following points: <ul style="list-style-type: none"> • Make sure the power supply voltage is set within the specified range. • Make sure a cable or wire is not disconnected.
---	P5↔ Node address of error	● All OFF	Output PS Voltage Low	See note 1.	I/O power (output) is not connected although a safety output terminal is used.	

- Note**
- (1) Not saved in Pre-Ver. 1.0 Controllers, but saved in Controllers with unit version 1.0 or later (including Controllers that support EtherNet/IP).
 - (2) These functions are not supported by Pre-Ver. 1.0 Controllers. The error information is saved in Controllers with unit version 1.0 or later (including Controllers that support EtherNet/IP).



Errors in Controllers that Support EtherNet/IP

Fatal Errors

Indicators/display			Error history		Cause	Corrective actions
NS	Seven-segment display	MS	Name	Saved in nonvolatile memory		
● OFF	UF	☉ Lit red	System Failure	Yes	EtherNet/IP adaptor hardware error	Turn the power OFF and back ON, and check operation. If the problem occurs again, it may be necessary to replace the Controller.

Nonfatal Errors

Indicators/display			Error history		Cause	Corrective actions
NS	Seven-segment display	MS	Name	Saved in nonvolatile memory		
☉ Lit red	F0↔n4	---	IP Address Duplication Error	Yes	IP address duplication error	The same IP address is set for another device on the network. Correct the settings so that there is no duplication, and then turn the power ON again.
● OFF	E3↔n4	---	Server Connection Error	Yes	BOOTP server connection error	Check the following points. <ul style="list-style-type: none"> • Make sure the cable is connected correctly. • Make sure the BOOTP server is operating normally.
● OFF	F2↔n4	---	Ethernet Basic Setting Error	Yes	Basic setting logic processing error	Correct the configuration. If the problem occurs again, replace the Controller.
● OFF	E9↔n4	☉ Lit red	Memory Access Error	Yes	EtherNet/IP memory error	Cycle the power supply. If the problem occurs again, replace the Controller.
● OFF	F4↔n4	☉ Lit red	Communications Controller Error	Yes	EtherNet/IP communications controller error	Cycle the power supply. If the problem occurs again, replace the Controller.

Indicators/display			Error history		Cause	Corrective actions
NS	Seven-segment display	MS	Name	Saved in nonvolatile memory		
 Flashing red	L9↔n4	---	Tag Data Link Error	Yes	EtherNet/IP standard target communications error	<p>Check the following points.</p> <ul style="list-style-type: none"> • Make sure the same communications settings are used for each node. • Make sure cables are not disconnected or bent. • Make sure power is supplied to the Originator.
 OFF	E1↔n4	---	Link OFF Error	Yes	Link OFF error	<p>Check the following points.</p> <ul style="list-style-type: none"> • Make sure the same communications settings are used for each node. • Make sure cables are not disconnected or bent. • Make sure power is supplied to the hub.
---	L8 ↔ Local node address	---	EtherNet/IP Standard Target Write Timeout	Yes	There was no refresh request within the set time after the access right to an EtherNet/IP standard target I/O area was acquired.	<p>Check the following items.</p> <ul style="list-style-type: none"> • Make sure the same communications settings are used for each node. • Make sure cables are not disconnected or loose. • Make sure power is supplied to the client. • Make sure that the client application is operating.

12-4 Error History

The error history records errors that the NE1A-series Controller detects in the total operating time of the Controller.

The error history can be read from the Network Configurator.

12-4-1 Error History Table

Error History Table

When an error is detected in a Pre-Ver. 1.0 NE1A-series Controller, the error is recorded in the error history table in the RAM of the Controller. The error history contains one record per error and can hold up to 20 records. If the error history table already contains 20 records, the oldest record is deleted and the new error data is stored.

When an error is detected in a NE1A-series Controller with unit version 1.0 or later (including Controllers that support EtherNet/IP), the error is recorded in the error history table in the RAM of the Controller. The error history contains one record per error and can hold up to 100 records. If the error history table already contains 100 records, the oldest record is deleted and the new error data is stored.

The following information is stored in the error history table:

- Status information when an error occurs
- The time when an error occurs (total operating time of the NE1A-series Controller)
- The node address where the error occurred or the error response value (when an explicit message is sent)

EtherNet/IP Error History Table

In addition to the error history table described above, the Controller has an EtherNet/IP error history table that holds up to 64 error records. If an error is recorded when the table already holds 64 error records, the oldest record is deleted and the newest record is stored.

IMPORTANT Check EtherNet/IP errors in the EtherNet/IP Error History Tab Page.

Error History Saving Area

The description of an error is recorded as an error history in the NE1A-series Controller's RAM, and if the error is critical, it is also saved in the nonvolatile memory. The error history recorded in nonvolatile memory is retained even when the power supply of the Controller is not supplied or restarted. The error history in the nonvolatile memory is copied to the RAM at the start of the Controller's power cycle.

The error history in RAM is read when reading the error history from the Network Configurator. When clearing the error history, however, the error history in both the RAM and nonvolatile memory are cleared.

Reading and Clearing the Error History Table

The error history can be displayed in realtime using the Error History Display function of the Network Configurator. The error history data can also be saved on the computer.

- Note**
- (1) The total operating time of the NE1A-series Controller is recorded as the accumulated time in 6-minutes increments while the power supply for the internal circuit is ON. The total operating time is cleared using a Control-

ler Reset Command addressed to the NE1A-series Controller to clear all or only specified variables to their default settings.

- (2) When the error history is read from the Network Configurator, the node address where the error occurred or the error response value is displayed as manufacturer-specific ALARM exception detail [7] 0x**.
- (3) When the NE1A-series Controller's error history is read from the Network Configurator, both the error status information and the node address where the error occurred or the error response value are displayed for each error history record.

The NE1A-series Controller's error histories are read by the Network Configurator as shown below.

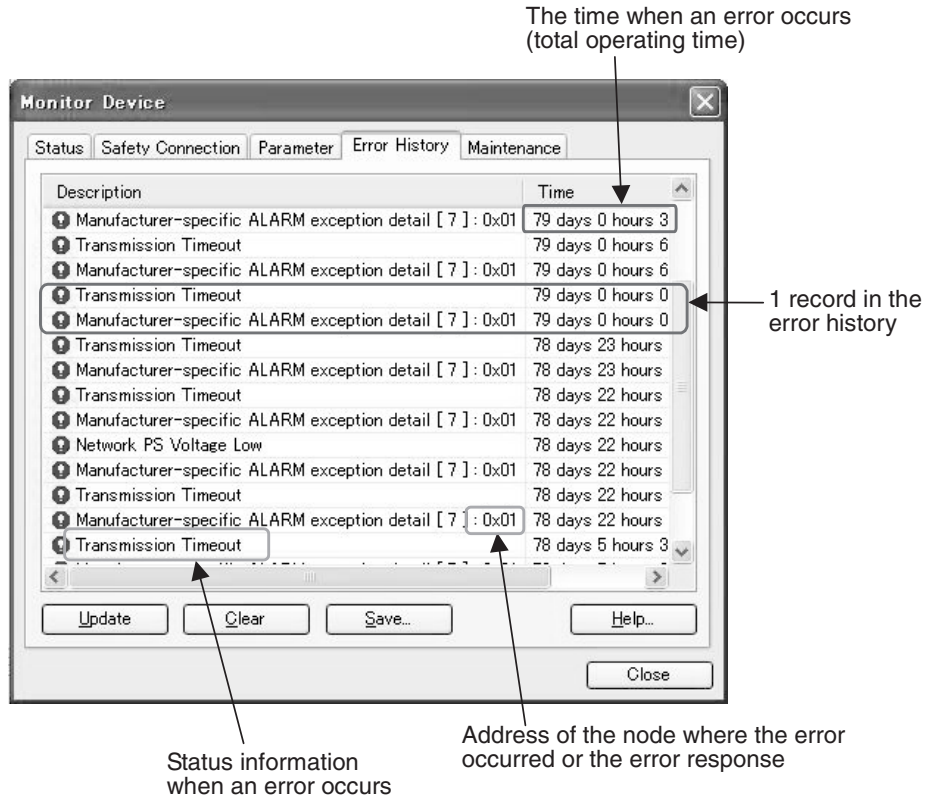

With Controllers that support EtherNet/IP, an EtherNet/IP Error History Tab can be selected in addition to the Error History Tab. This information appears as follows when read from the Network Configurator.

Time error occurred (total operation time)

Error information

The screenshot shows a software window titled "Monitor Device" with a tabbed interface. The "Error History" tab is active, displaying a table of error events. The table has four columns: "Time of Error", "Error Inf.", "Detailed.", and "Content". The "Content" column contains error descriptions such as "Link OFF error." and "Server connection error.". Below the table are buttons for "Update", "Clear", "Save...", "Help...", and "Close".

Time of Error	Error Inf..	Detailed..	Content
13 days 1 hours 36 ...	03D3	0000	Link OFF error.
12 days 3 hours 6 mi...	03C4	0401	Server connection error.
12 days 3 hours 6 mi...	03D3	0000	Link OFF error.
12 days 2 hours 54 ...	03C4	0401	Server connection error.
12 days 2 hours 54 ...	03D3	0000	Link OFF error.
12 days 2 hours 54 ...	03C4	0401	Server connection error.
12 days 2 hours 54 ...	03D3	0000	Link OFF error.
12 days 2 hours 54 ...	03C4	0401	Server connection error.
12 days 2 hours 53 ...	03D3	0000	Link OFF error.
11 days 23 hours 18 ...	03C4	0401	Server connection error.
11 days 23 hours 18 ...	03D3	0000	Link OFF error.
11 days 23 hours 12 ...	03C4	0401	Server connection error.
11 days 23 hours 12 ...	03D3	0000	Link OFF error.
11 days 23 hours 11 ...	03C4	0401	Server connection error.
11 days 23 hours 11 ...	03D3	0000	Link OFF error.

12-4-2 Error Information Details

Message		Corrective Actions
NE1A-series Controller System Failures		
System Failure	System failure	Replace the unit if the system failure still occurs after turning ON the power supply again.
Invalid Configuration	Configuration invalid	Configuration differs from the original configuration. Reconfigure after checking.
Programming-related Errors		
Function Block Status Error	Function Block Status Error	An incompatible signal input was set as an input condition in the function block's Set Parameters. Check the inputs entered in the function block or the program logic.
DeviceNet Communications Errors		
Switch Setting Mismatch	Switch setting mismatch	Check that the node address is the same as the one in the last configuration. If not, change back to the same node address or reconfigure. If the error occurs again, replace the unit.
Duplicate MAC ID	Node address duplication	Check the node address of other nodes. Correct the configuration so that each node address is used only once and then cycle the power supply.
Network PS Voltage Low	Network power supply voltage low error	Check the following points: <ul style="list-style-type: none"> • Make sure the power supply voltage is set within the specification range. • Make sure a cable or wire is not disconnected.
Bus Off	Bus Off (Communications cut off by frequent data errors.)	Check the following points: <ul style="list-style-type: none"> • Make sure the baud rate is the same for all nodes. • Make sure the cable lengths (of main/branch lines) are not too long. • Make sure a cable or wire is not disconnected or loose. • Make sure terminating resistance is at both ends of the main line and only at both ends. • Make sure there is not a lot of noise. • Make sure power is being supplied to the Slave.
Transmission Timeout	Transmission timeout	
Standard I/O Connection Timeout	Standard I/O connection timeout	
Relevant Safety I/O communication stopped	The corresponding safety I/O connection was stopped due to a safety I/O connection timeout.	
All Safety I/O communication stopped	All safety I/O connections were stopped due to a safety I/O connection timeout.	
Safety I/O Connection Timeout	Safety I/O connection timeout	
Nonexistent Slave Device	No slave	
Safety I/O Connection Establishment Failure	Safety I/O connection establishment error	Check the following points on the slave device: <ul style="list-style-type: none"> • Make sure it is configured. • Make sure it is operating normally.
Invalid Slave Device	Unauthorized slave device (verification error)	Verify the slave device (select Device - Parameters - Compare) and connect a suitable slave device.
EM Transmission Error (Duplicate MAC ID)	Unable to transmit due to node address duplication.	Refer to the section on <i>Duplicate MAC ID</i> .
EM Transmission Error (Invalid Header)	Unable to transmit due to invalid header.	Check the following points: <ul style="list-style-type: none"> • Node address of the transmission message • Class ID of the transmission message • Instance ID of the transmission message
EM Transmission Error (Device Offline)	Unable to transmit because local device is not on the network.	Check the following points: <ul style="list-style-type: none"> • Make sure the baud rate is the same for all nodes. • Make sure the cable lengths (of main/branch lines) are not too long. • Make sure a cable or wire is not disconnected or loose. • Make sure terminating resistance is at both ends of the main line and only at both ends. • Make sure there is not a lot of noise. • Make sure the power supply voltage for the network power source is set within the specification range.
EM Transmission Error (Message ID Error)	Unable to transmit due to message ID error.	
EM Transmission Error (Response Timeout)	Unable to transmit due to response timeout.	

Message		Corrective Actions
EM Transmission Error (Destination Device Absence)	Unable to transmit because the destination device is not on the network.	Check the following points: <ul style="list-style-type: none"> • Node address of the destination node • Node address of the transmission message • Make sure the power supply voltage for the destination node is set within the specification range. • Make sure the baud rate is the same for all nodes. • Make sure the cable lengths (of main/branch lines) are not too long. • Make sure a cable or wire is not disconnected or loose. • Make sure terminating resistance is at both ends of the main line and only at both ends. • Make sure there is not a lot of noise.
EM Transmission Error (Destination Buffer Full)	Unable to transmit because the destination buffer was busy.	Check the message reception size at the destination node.
EM Transmission Error (Command Length Error)	Unable to transmit because the command is longer than the maximum length.	Check the response message size from the destination. Or check that the response size expected in the request message is correct.
EM Transmission Error (New Request Received)	Message was deleted due to receiving the new request.	No
Received Error Response (UEM)	Receiving an error response when the user explicit message function is used.	Check that the specified service or data size in the user explicit message matches the destination object specifications.
Error Related to Power Supply for I/O		
Input PS Voltage Low	I/O power supply (input) is not connected.	Check the following points: <ul style="list-style-type: none"> • Make sure the power supply voltage is set within the specification range. • Make sure that a cable or wire is not disconnected.
Output PS Voltage Low	I/O power supply (output) is not connected.	
Safety Input Terminal-related Failures		
External Test Signal Failure at Safety Input	Failure in the external wire at safety input	Check the following points: <ul style="list-style-type: none"> • Make sure the input signal wire is not contacting the power source (positive side). • Make sure the input signal wire does not have an earth fault. • Make sure the input signal wire is not disconnected. • Make sure there is not a short circuit between input signal wires. • Make sure a failure had not occurred in the connected device. • Make sure the set value of discrepancy time is valid. <p>To recover from these failures, the following conditions are required: Latch input error time must have passed, and the root cause must have been removed. The target safety input terminal inputs must turn OFF.</p> <p>When changing the discrepancy time, reconfiguration is required.</p>
Discrepancy Error at Safety Input	Discrepancy error between two inputs at safety input	
Internal Input Failure at Safety Input	Internal circuit failure at safety input	Replace the unit if the system failure still occurs after cycling the power supply.
Test Output Terminal-related Failures		
Overload Detected at Test Output	Overloading was detected at test output.	Check whether the output signal wire has an earth fault or is overloaded.
Stuck-at-high Detected at Test Output	Stuck-at-high at test output	Check whether the power source (positive side) is contacting the output signal wire. After the latch input error time has passed, turn OFF the input when the cause of the error has been removed, and the error will be reset. If there is no fault with the wires, replace the unit.
Under Current Detected Using Muting Lamp	Lower limit error of current was detected at test output.	Check whether the output signal wire is disconnected. If there is no fault with the wires, check the indicators.

Message		Corrective Actions
Safety Output Terminal-related Failures		
Over Current Detected at Safety Output	Overcurrent was detected at safety output.	Check the following points: <ul style="list-style-type: none"> • Make sure there is no overcurrent for the output. • Make sure the output signal wire does not have an earth fault. • Make sure the output signal wire is not contacting the power source (positive side). • Make sure there is not a short circuit between output signal wires. To recover from these failures, the following conditions are required: Latch output error time must have passed, and the root cause must have been removed. The output signal from the user application for the target safety output must turn OFF.
Short Circuit Detected at Safety Output	Short circuit was detected at safety output.	
Stuck-at-high Detected at Safety Output	Stuck-at-high at safety output	
Cross Connection Detected at Safety Output	Short circuit was detected between output signal wires at safety output.	
Dual Channel Violation at Safety Output	Output data error at safety output	Check whether the data of the two outputs in the Dual Channel Mode are configured as equivalent channels.
Ethernet Errors (CPU Units with EtherNet/IP)		
EtherNet/IP Standard Target Communications Error	EtherNet/IP standard target communications error	Check the following items. <ul style="list-style-type: none"> • Make sure the same communications settings are used for each node. • Make sure cables are not disconnected or loose. • Make sure power is supplied to the originator.
EtherNet/IP Standard Target Write Timeout	EtherNet/IP Standard Target Write Timeout	Check the following items. <ul style="list-style-type: none"> • Make sure the same communications settings are used for each node. • Make sure cables are not disconnected or loose. • Make sure power is supplied to the client. • Make sure that the client application is operating.

12-4-3 EtherNet/IP Error History

Message	Error information	Error information details		Corrective Actions
		1 st byte	2 nd byte	
Memory access error	0602	01: Read error 02: Write error	Not set.	Cycle the power supply. If the problem occurs again, replace the Controller.
Ethernet communications controller error	020F	00	01	Cycle the power supply. If the problem occurs again, replace the Controller.
IP address duplication	0211	02	Rightmost 8 bits of IP address	The same IP address is set for another device on the network. Check the IP addresses of the other devices, and set an address that does not duplicate any other.
Device parameter error	021A	00	Not set.	Correct the configuration. If the problem occurs again, replace the Controller.
Server connection error	03C4	04: BOOTP	01: Specified host cannot be found. 07: Send error 08: Receive error 0A: Acquired IP address error	Check the following points. <ul style="list-style-type: none"> • Make sure the cable is connected correctly. • Make sure the BOOTP server is operating normally.

Message	Error information	Error information details		Corrective Actions
		1 st byte	2 nd byte	
Ethernet basic setting error	03D0	01: Ethernet setting error	01: Checksum error 11: Inconsistent settings 12: Specified baud rate not supported.	Correct the settings. If the problem occurs again, replace the Controller.
		02: TCP/IP basic setting error	01: Checksum error 11: Illegal IP address 12: Illegal subnet mask 13: Illegal default gateway address 14: Illegal primary name server 15: Illegal secondary name server 16: Illegal domain name 17: Illegal host name	
Tag data link error	03D5	00	Rightmost 8 bits of IP address	Check the following points. <ul style="list-style-type: none"> • Make sure the same communications settings are used for each node. • Make sure cables are not disconnected or bent. • Make sure power is supplied to the Originator.
Link OFF error	03D3	00	00	Check the following points. <ul style="list-style-type: none"> • Make sure the same communications settings are used for each node. • Make sure cables are not disconnected or bent. • Make sure power is supplied to the hub.

12-5 Errors When Downloading

12-5-1 Outline

An NE1A-series Controller or other Safety Device may return an error when configuration data is downloaded to them. The cause of the error can be determined from the error information displayed on the Network Configurator.

12-5-2 Error Messages and Countermeasures

Message displayed on the Network Configurator	Countermeasure
Cannot be executed in the current mode.	A fatal error (Abort) (MS indicator flashes red) has occurred. Set the switches correctly or execute reset (restarting with factory default settings) to clear the configuration data.
The device is locked.	The configuration data is locked. (LOCK indicator is lit.) Release the lock.
The TUNID is different.	<p>The device is waiting for a TUNID setting after being reset (NS indicator is flashing green/red) or the TUNID of the Network Configurator is different from the device when downloading. Use the following steps to check the setting.</p> <ol style="list-style-type: none"> 1. Reset the device to default settings and then download the parameters again. The network number may, however, be different from other devices. If the Controller's 7-segment display shows "d6" (a Safety I/O Connection Establishment Failure message appears on the Error History Tab Page in the Network Configurator Monitor Device Window when Device – Device Monitor is selected) after the operating mode has been changed, use steps (2) or (3) to correct the error. 2. Select Network – Upload in the Network Configurator. Unify the network numbers and reset all devices to the default settings. Once reset, download the parameters to all devices again. 3. Select Network – Property, and then click the Get from Network Button in the Network Number Field in the dialog box that appears. If there are multiple network numbers, select one of these numbers to unify all to that network number.
Privilege violation.	1. The password that is being used does not have the right to change the configuration. Check to see if the password is correct.
	2. An attempt was made to disable DeviceNet communications (Standalone) through a DeviceNet connection. Connect the Network Configurator via the USB connector and download the parameters again. With Controllers that support EtherNet/IP, it is also possible to download via EtherNet/IP.
Cannot be executed in the current device mode.	Downloading from more than one Network Configurator at the same time. Wait until other downloads have been completed.

Message displayed on the Network Configurator	Countermeasure
<p>An error was found during parameter check.</p>	<ol style="list-style-type: none"> 1. There is a non-alignment between configuration parameters. Check the following items and change the parameters. <ul style="list-style-type: none"> • The time parameters (e.g., Discrepancy Time) set for function blocks in the NE1A-series Controller's settings is shorter than the Controller's cycle time. • The safety connection EPI is shorter than the cycle time. • The safety input channel mode is set to <i>Test pulse from test output</i>, but the test source has not been set. • One of the safety inputs in a dual channel setting is set as a standard input and the other has a different setting. • One of the safety inputs in a dual channel setting is set to <i>Not used</i> and the other has a different setting. • One of the safety outputs in a dual channel setting is set to <i>Not used</i> and the other has a different setting. • The maximum number of connection IDs for one Safety Master (12) has been exceeded in the safety I/O configuration. Change the ID allocation under Edit Safety Connection – Expansion Connection Setting to "Check Produced IDs in the Safety Slave" in the corresponding Safety I/O Connection (Safety Input Assembly) setting, then download the device parameters to the Safety Master again. 2. The program may have been created with an earlier Network Configurator than version 1.5□. The checks for safety functions have been improved in version 1.5□ so programs created in an earlier version cannot be downloaded as is. Use the following procedure to convert the program and then download the program again. <ol style="list-style-type: none"> a. Click the Edit Button on the Logic Tab page in the Edit Device Parameters Window of the NE1A-series Controller to open the Logic Editor. b. Select Edit – Find Function Blocks with Open Connections to check whether all function block I/O are connected. For information on open function block connections, refer to Finding Function Blocks with Open Connections in <i>6-3-3 Programming Using Function Blocks</i> and <i>Precautions Updating from Network Configurator Version 1.3□ to a Higher Version</i> in the <i>DeviceNet Safety System Configuration Manual (Z905-E1-07 or higher)</i>. c. Select File – Apply to save the user program then close the Logic Editor. d. Return to the NE1A-series Controller's Edit Device Parameters Window and click the OK Button. 3. The hardware may be malfunctioning. Cycle the NE1A-series Controller's power and execute self-diagnosis. If the MS indicator is lit red, replace the hardware.
<p>The data used by the user program is not aligned with other data.</p>	<p>The network configuration has changed, which has resulted in a non-alignment between the user program data and other data. Start Logic Editor and check changed I/O locations and make the settings again.</p>
<p>Could not access the device.</p>	<ol style="list-style-type: none"> 1. Device is waiting for a TUNID setting (NS indicator is flashing green/red) after reset was executed from another node during download. Set the TUNID and download again. Refer to <i>3-4-2 Network Numbers</i> in the <i>DeviceNet Safety System Configuration Manual (Z905)</i> for information on TUNIDs. 2. For NE1A-series Controllers that support EtherNet/IP, downloading is not possible from the EtherNet/IP sheet. Switch to the DeviceNet sheet to download.
<p>Could not open connection.</p>	<ol style="list-style-type: none"> 1. Could not establish connection with device when downloading to the device via DeviceNet or EtherNet/IP. Check that the power is ON to the device and download again. 2. The connection resources available for the device are being used to establish safety I/O connections with the Safety Master, so a connection cannot be established with the Network Configurator. Change the operation mode of the Safety Master to which the safety connections are registered to IDLE mode. 3. If the above causes do not apply, noise or other factors may be making communications unstable. Check the following items. <ul style="list-style-type: none"> • Do all nodes have the same baud rate? • Is the cable length correct (trunk lines and branch lines)? • Is the cable disconnected or slack? • Is the terminating resistance only on both ends of the main line?
<p>Message could not be sent.</p>	<p>Downloaded via USB or EtherNet/IP to the device but could not connect to the device. Check that the power is turned ON to the device and download again.</p>

Message displayed on the Network Configurator	Countermeasure
<p>Connection failed.</p>	<p>Tried to configure a device on the DeviceNet or EtherNet/IP network via the NE1A-series Controller's USB port, but connection failed. Check that power is turned ON to the device and download again.</p> <p>If the above cause does not apply, noise or other factors may be making communications unstable. Check the following items.</p> <ul style="list-style-type: none"> • Do all nodes have the same baud rate? • Is the cable length correct (trunk lines and branch lines)? • Is the cable disconnected or slack? • Is the terminating resistance only on both ends of the main line? • Is there a lot of noise?
<p>Program incomplete. Start Logic Editor and check program.</p>	<p>There are open inputs or outputs in a function block used in the user program. Click the Edit Button on the Logic Tab Page to open the logic and perform the following measures.</p> <ul style="list-style-type: none"> • Connect the open inputs or outputs. • Change the number of I/O setting for the function block to delete the open input or output. <p>Function blocks with open inputs or outputs can be searched by using Edit – Find Function Blocks with Open Connections. For information on open function block connections, refer to Finding Function Blocks with Open Connections in <i>6-3-3 Programming Using Function Blocks</i> and <i>Precautions Updating from Network Configurator Version 1.3 to a Higher Version</i> in the <i>DeviceNet Safety System Configuration Manual</i> (Z905-E1-07 or higher).</p>

12-6 Errors When Resetting

12-6-1 Outline

The NE1A-series Controller may return an error response when it is reset. The messages displayed on the Network Configurator can be used to identify and correct the error.

12-6-2 Error Messages and Countermeasures

Message displayed on the Network Configurator	Countermeasures
Cannot execute in current mode.	The specified reset cannot be executed in the current device status. Refer to 9-2-2 <i>Reset Type and NE1A-series Controller Status</i> and change the operating mode or configuration lock status of the Controller. Then execute the reset again.
The device has a different TUNID. The device TUNID will be used to reset. Is that OK?	<ol style="list-style-type: none"> The TUNID saved to the device and the TUNID specified by Network Configurator do not match. Check that the device node address matches and execute the reset if it is OK to use the device TUNID. This message will be displayed if an attempt is made to reset an NE1A-series Controller that supports EtherNet/IP from the EtherNet/IP sheet. If there is no problem in using the device TUNID to reset the Controller, then reset the Controller.
Access error	The password used does not provide authority to change configurations. Check that the correct password is being used.
The device cannot be accessed or the device type or password is different.	1. The device has just been reset or the power cycled and the device is not ready for communications (i.e., not online with the NS indicator flashing or lit green.) Check that the device is communications ready then reset.
	2. The device specified for reset may not support that service. Check that the device node address is correct.
	3. The configuration data is locked. (The LOCK indicator is lit.) Remove the lock then execute the specified reset.
	4. The device is performing safety I/O communications and cannot, therefore, execute the specified reset. Change the operating mode of the relevant Safety Master to IDLE mode. Then execute the specified reset.
Connection failed.	<p>Tried to reset a device on the DeviceNet or EtherNet/IP network via the NE1A-series Controller's USB port, but connection failed. Check that power is turned ON to the device and reset again.</p> <p>If the above cause does not apply, noise or other factors may be making communications unstable. Check the following items.</p> <ul style="list-style-type: none"> • Do all nodes have the same baud rate? • Is the cable length correct (trunk lines and branch lines)? • Is the cable disconnected or slack? • Is the terminating resistance only on both ends of the main line? • Is there a lot of noise?
The specified operation is not possible on this network. Use the DeviceNet network (for Controllers that support EtherNet/IP).	This message will be displayed if an attempt is made to reset an NE1A-series Controller that supports EtherNet/IP from the EtherNet/IP Network Window. If there is no problem in using the device TUNID to reset, then reset the Controller from the EtherNet/IP Network Window.

12-7 Errors When Changing Modes

12-7-1 Outline

The NE1A-series Controller may return an error response when its operating mode is being changed. The messages displayed on the Network Configurator can be used to identify and correct the error.

12-7-2 Error Messages and Countermeasures

Message Displayed on the Network Configurator	Countermeasures
Cannot be executed in the current mode.	<ol style="list-style-type: none"> 1. The device has not been configured (Configuring Mode). Download the device parameters. 2. A fatal error (Abort) has occurred. Set the switches correctly or execute reset (restarting with factory default settings) to clear the configuration data. Once the configuration data is cleared, download the device parameters again.
Already set to the specified mode.	The device is already in the specified operating mode.
The device has a different TUNID.	The TUNID saved to the device and the TUNID specified by the Network Configurator do not match. Check that the device node address matches. If it does, it means that the device network number and the network number in the Network Configurator do not match. Select Network – Upload in the Network Configurator to match the network numbers.
Access error	The password used does not provide authority to change the operating mode. Check that the correct password is being used.
The device cannot be accessed or the device type or password is different.	<ol style="list-style-type: none"> 1. The device has just been reset or the power cycled and the device is not ready for communications (i.e., not online with the NS indicator flashing or lit green.) Check that the device is communications ready then reset. 2. The device for which the operating mode change request was made may not support that service. Check that the device node address is correct.
Connection failed.	<p>Tried to change the operating mode of a device on the DeviceNet or Ether-Net/IP network via the NE1A-series Controller's USB port, but connection failed. Check that power is turned ON to the device and reset again.</p> <p>If the above cause does not apply, noise or other factors may be making communications unstable. Check the following items.</p> <ul style="list-style-type: none"> • Do all nodes have the same baud rate? • Is the cable length correct (trunk lines and branch lines)? • Is the cable disconnected or slack? • Is the terminating resistance only on both ends of the main line? • Is there a lot of noise?

12-8 Connection Status Tables

12-8-1 Outline

If an error occurs when the NE1A-series Controller tries to establish a safety connection with a DST1-series Safety I/O Terminal or an NE1A-series Controller set as a Slave, the 7-segment display will display the error code "d6" or "d5." If an error occurs during I/O communications, the 7-segment display will display the error code "dA" or "bA."

Check the status code (error code) shown on the Safety Connection Tab Page in the Monitor Device Window and take the corresponding countermeasure.

12-8-2 Connection Status for DST1 Series

Status		Countermeasure
00:0001	Normal communications	The Safety I/O connection status is normal.
01:0001	Safety I/O Connection Timeout	The Safety I/O connection has timed out. Check the following items. <ul style="list-style-type: none"> • Do all nodes have the same baud rate? • Is the cable length correct (trunk lines and branch lines)? • Is the cable disconnected or slack? • Is the terminating resistance only on both ends of the main line? • Is there a lot of noise? • Is the network bandwidth allocation suitable?
01:0105	Configuration Owner Error	The Safety Slave was configured from a configuration tool or Safety Master at a different node address last time. Reset the Safety Slave to the default settings and download the device parameters again. Refer to <i>5-1-2 Setting Safety Connection Parameters</i> in the <i>DeviceNet Safety System Configuration Manual (Z905-E1-07 or higher)</i> for information on configuration owners.
01:0106	Output connection Owner Error	The Safety Slave established output safety I/O connections with a Safety Master at a different node address last time. Reset the Safety Slave to the default settings and download the device parameters again. Refer to <i>5-1-2 Setting Safety Connection Parameters</i> in the <i>DeviceNet Safety System Configuration Manual (Z905-E1-07 or higher)</i> for information on output connection owners.
01:0110	Device Not Configured	The Safety Slave has not been configured. Download the device parameters to the Safety Slave.
01:0113	No. of Connections Error	The setting for the number of safety I/O connections exceeds the upper limit supported by the Safety Slave. Adjust the Safety Connection setting for the relevant Safety Master.
01:0114	Vendor ID or Program Code Error	The device data (vendor ID or product code) for the device on the Configurator and the device used in the actual system does not match. <ul style="list-style-type: none"> • Use Safety Slave Verification (Device – Parameter – Verify) to check that the device in the system and the device registered to the Safety Master match. • If they do match, delete then re-register the connections registered to the Safety Master.
01:0115	Device Type Error	The device data (device type) for the device on the Configurator and the device used in the actual system does not match. <ul style="list-style-type: none"> • Use Safety Slave Verification (Device – Parameter – Verify) to check that the device in the system and the device registered to the Safety Master match. • If they do match, delete then re-register the connections registered to the Safety Master.
01:0116	Revision Error	The device data (revision) for the device on the Configurator and the device used in the actual system does not match. <ul style="list-style-type: none"> • Use Safety Slave Verification (Device – Parameter – Verify) to check that the device in the system and the device registered to the Safety Master match. • If they do match, delete then re-register the connections registered to the Safety Master.

Status		Countermeasure
01:0117	Connection Path Error	<p>1. Two or more output safety I/O connections have been set for the Safety Slave.</p> <ul style="list-style-type: none"> • Change the Safety Connection setting for the Safety Master so there is only one connection. Then reset the Safety Slave to default settings and download the device parameters to the Safety Slave again. <p>2. The same output assembly number for a Safety Slave has been used for both a Safety Master and a Standard Master.</p> <ul style="list-style-type: none"> • Input assembly numbers can be duplicated but output assembly numbers cannot. Check the Safety Connection setting for both the Safety Master and the Standard Master then return the Safety Slave to default settings and download the device parameters to the Safety Slave again. • If the error remains even after the above countermeasure has been performed, delete and re-register the connections registered to the Safety Master.
01:0119	Safety I/O Communications Failure	<p>The execution mode of the DST1-XD□□ Safety Slave was set to Auto Execution. Safety I/O communications are not possible in Auto Execution Mode. If the DST1-XD□□ Safety Slave is to be used with safety I/O communications, set the execution mode to <i>After Establishing Safety I/O Connection</i>.</p>
01:031E	No. of Connections Error	<p>The setting for the number of safety I/O connections exceeds the upper limit supported by the Safety Slave. Adjust the Safety Connection setting for the relevant Safety Master. In particular, check that no more than 15 Safety Masters are set for each Multicast connection, with a maximum total of 30.</p>
01:031F	Connection ID Resource Error	<p>The maximum number of connection IDs for one Safety Master (12) has been exceeded.</p> <p>Change the ID allocation under Edit Safety Connection – Expansion Connection Setting to “Check Produced IDs in the Safety Slave” in the corresponding Safety I/O Connection (Safety Input Assembly) setting, then download the device parameters to the Safety Master again.</p>
01:07FF	Non-existent Safety Slave	<p>The Safety Slave may not have been added to the network correctly. Check that the corresponding Safety Slave is online (i.e., the NS indicator is flashing green or lit green.) If the Safety Slave is not online, check the following items.</p> <ul style="list-style-type: none"> • Is the node address for the Safety Slave correct? • Do all nodes have the same baud rate? • Is the cable length correct (trunk lines and branch lines)? • Is the cable disconnected or slack? • Is the terminating resistance only on both ends of the main line? • Is there a lot of noise?
01:080C	Safety Signature Mismatch	<p>The safety signature for the Safety Slave monitored by the Safety Master does not match the safety signature of the Safety Slave itself.</p> <ul style="list-style-type: none"> • Reset the Safety Slave to default settings then download the device parameters again. • If the above remedy does not work, delete then re-register the connections registered to the Safety Master.
01:080E	TUNID Mismatch	<p>The TUNID for the Safety Slave monitored by the Safety Master does not match the TUNID of the Safety Slave itself.</p> <ul style="list-style-type: none"> • Reset the Safety Slave to default settings then download the correct device parameters. • If the above remedy does not work, delete then re-register the connections registered to the Safety Master. <p>Refer to 3-4-2 Network Numbers in the <i>DeviceNet Safety System Configuration Manual (Z905)</i> for information on TUNIDs.</p>

Status		Countermeasure
01:080F	Safety Configuration not possible	<p>1. The Safety Slave is configuration locked and <i>Configure the target device</i> is selected for the Open Type setting for the Safety Master connection.</p> <ul style="list-style-type: none"> • Release the configuration lock on the Safety Slave to configure the Safety Slave from the Safety Master. • To configure the Safety Slave from a configuration tool, set the Safety Master connection to <i>Check the safety signature</i> under Open Type. Then reset the Safety Slave to default settings and download the device parameters to the Safety Slave again. <p>2. The execution mode of the DST1-XD□□ Safety Slave was set to Auto Execution and then the open type setting in the safety connection settings in the safety master was set to configure a safety slave.</p> <ul style="list-style-type: none"> • Safety I/O communications are not possible in Auto Execution Mode. If the DST1-XD□□ Safety Slave is to be used with safety I/O communications, set the execution mode to After Establishing Safety I/O Connection.
D0:0001	IDLE Mode	Safety I/O communications have not been started because the NE1A-series Controller that is the safety master is in IDLE Mode. Change the Controller to RUN mode.

12-8-3 Connection Status for the NE1A-series Controller (Safety Slave Function)

Status		Countermeasures
00:0001	Normal communications	The Safety I/O connection status is normal.
01:0001	Safety I/O Connection Timeout	<p>The Safety I/O connection has timed out. Check the following items.</p> <ul style="list-style-type: none"> • Do all nodes have the same baud rate? • Is the cable length correct (trunk lines and branch lines)? • Is the cable disconnected or slack? • Is the terminating resistance only on both ends of the main line? • Is there a lot of noise? • Is the network bandwidth allocation suitable?
01:0106	Output Connection Owner Error	<p>The Safety Slave has previously established an output safety I/O connection with a Safety Master at a different node address.</p> <p>Reset the Safety Slave to the default settings, and then download the device parameters again.</p> <p>Refer to <i>5-1-2 Setting Safety Connection Parameters</i> in the <i>DeviceNet Safety System Configuration Manual (Z905-E1-07 or higher)</i> for information on output connection owners.</p>
01:0109	Data Size Error	The Safety Slave I/O size set to the NE1A-series Safety Slave and the size set under the Safety Master safety connection setting does not match. The Safety Slave I/O setting may have been changed, so delete then re-register the connections registered to the Safety Master.
01:0110	Unconfigured Device	The Safety Slave has not been configured. Download the device parameters to the Safety Slave.
01:0111	EPI Error	The EPI set under the Safety Master safety connection setting is smaller than the Safety Slave cycle time. The EPI must be longer than both the Safety Master and the Safety Slave cycle times. Check the Safety Master safety connection setting.
01:0113	No. of Connections Error	The setting exceeds the maximum number of safety I/O connections supported by the Safety Slave. Check the relevant Safety Master safety connection settings.
01:0114	Vendor ID or Product Code Error	<p>The device data (vendor ID or product code) for the device on the Configurator and the device used in the actual system does not match.</p> <ul style="list-style-type: none"> • Use Safety Slave Verification (Device – Parameter – Verify) to check that the device in the system and the device registered to the Safety Master match. • If they do match, delete then re-register the connections registered to the Safety Master.

Status		Countermeasures
01:0115	Device Type Error	<p>The device data (device type) for the device on the Configurator and the device used in the actual system does not match.</p> <ul style="list-style-type: none"> • Use Safety Slave Verification (Device – Parameter – Verify) to check that the device in the system and the device registered to the Safety Master match. • If they do match, delete then re-register the connections registered to the Safety Master.
01:0116	Revision Error	<p>The device data (revision) for the device on the Configurator and the device used in the actual system does not match.</p> <ul style="list-style-type: none"> • Use Safety Slave Verification (Device – Parameter – Verify) to check that the device in the system and the device registered to the Safety Master match. • If they do match, delete then re-register the connections registered to the Safety Master.
01:0117	Connection Path Error	<p>Two ore more single-cast safety I/O connections or a multicast safety I/O connection with a different EPI has been set for a safety slave I/O.</p> <ul style="list-style-type: none"> • To share one safety slave I/O on a Safety Slave with more than one Safety Master, make the EPI all the same and set the connection type to Multicast. • NE1A-series Safety Slaves cannot have more than one single-cast safety I/O connection for each Safety Slave I/O. Set multiple connection paths for the NE1A-series Safety Slave Safety Slave I/O. • If the connection is not restored with the above remedy, delete then re-register the connections registered to the Safety Master.
01:031E	No. of Connections Error	<p>The setting for the number of safety I/O connections exceeds the upper limit supported by the Safety Slave. Adjust the Safety Connection setting for the relevant Safety Master. In particular, check that no more than 15 Safety Masters are set for each Multicast connection, with a maximum total of 60.</p>
01:031F	Connection ID Resource Error	<p>The maximum number of connection IDs for one Safety Master (12) has been exceeded.</p> <p>Change the ID allocation under Edit Safety Connection – Expansion Connection Setting to “Check Produced IDs in the Safety Slave” in the corresponding Safety I/O Connection (Safety Input Assembly) setting, then download the device parameters to the Safety Master again.</p>
01:07FF	Non-existent Safety Slave	<p>The Safety Slave may not have been added to the network correctly. Check that the corresponding Safety Slave is online (i.e., the NS indicator is flashing green or lit green.) If the Safety Slave is not online, check the following items.</p> <ul style="list-style-type: none"> • Is the node address for the Safety Slave correct? • Do all nodes have the same baud rate? • Is the cable length correct (trunk lines and branch lines)? • Is the cable disconnected or slack? • Is the terminating resistance only on both ends of the main line? • Is there a lot of noise?
01:080C	Safety Signature Mismatch	<p>The safety signature for the Safety Slave monitored by the Safety Master does not match the safety signature of the Safety Slave itself.</p> <ul style="list-style-type: none"> • Reset the Safety Slave to default settings then download the device parameters again. • If the above remedy does not work, delete then re-register the connections registered to the Safety Master.

Status		Countermeasures
01:080E	TUNID Mismatch	<p>The TUNID for the Safety Slave monitored by the Safety Master does not match the TUNID of the Safety Slave itself.</p> <ul style="list-style-type: none"> • Reset the Safety Slave to default settings then download the correct device parameters. • If the above remedy does not work, delete then re-register the connections registered to the Safety Master. <p>Refer to 3-4-2 Network Numbers in the <i>DeviceNet Safety System Configuration Manual (Z905)</i> for information on TUNIDs.</p>
C0:0002	Safety slave that is communications partner is in IDLE Mode	<p>The communications partner, a NE1A-series Controller that is functioning as a safety slave, is in IDLE Mode, so a safety I/O connection cannot be established. Change the operating mode of the communications partner to RUN Mode.</p>
D0:0001	IDLE Mode	<p>The NE1A-series Controller that is functioning as the safety master is in IDLE mode, so a safety I/O communications have not been started. Change the Controller's operating mode to RUN mode.</p>

SECTION 13

Maintenance and Inspection

13-1 Inspection	272
13-2 NE1A-series Controller Replacement.....	273

13-1 Inspection

To use an NE1A-series Controller's functions in the best condition, daily or periodical inspection must be performed.

- Check that the NE1A-series Controller is used within the range of specifications.
- Check that installation conditions and wiring of the NE1A-series Controller are proper.
- Diagnose the safety functions to maintain a level of operating reliability in safety functions.

13-2 NE1A-series Controller Replacement

Note the following points when you find a defect and replace the NE1A-series Controller:

- Do not disassemble, repair, or modify the NE1A-series Controller. To do so is dangerous because the original safety functions would be lost.
- Replace the unit in conditions where safety is ensured.
- To prevent electric shocks or unexpected performance of the device, perform the replacement after turning OFF the power supply.
- Check that there is no error in the new unit after replacement.

 **WARNING**

Serious injury may possibly occur due to loss of required safety function. To restart operation after replacing the NE1A-series Controller, reset all necessary configuration information, such as the user program. Check that the safety functions perform properly before starting actual operation.



Appendix A

Appendix 1: Usage Examples by Application

A-1-1 Emergency Stop Application

Safety category	Safety detection device	Stop category	Reset method
Equivalent to 4	Emergency stop push-button	0	Manual

Wiring Diagram

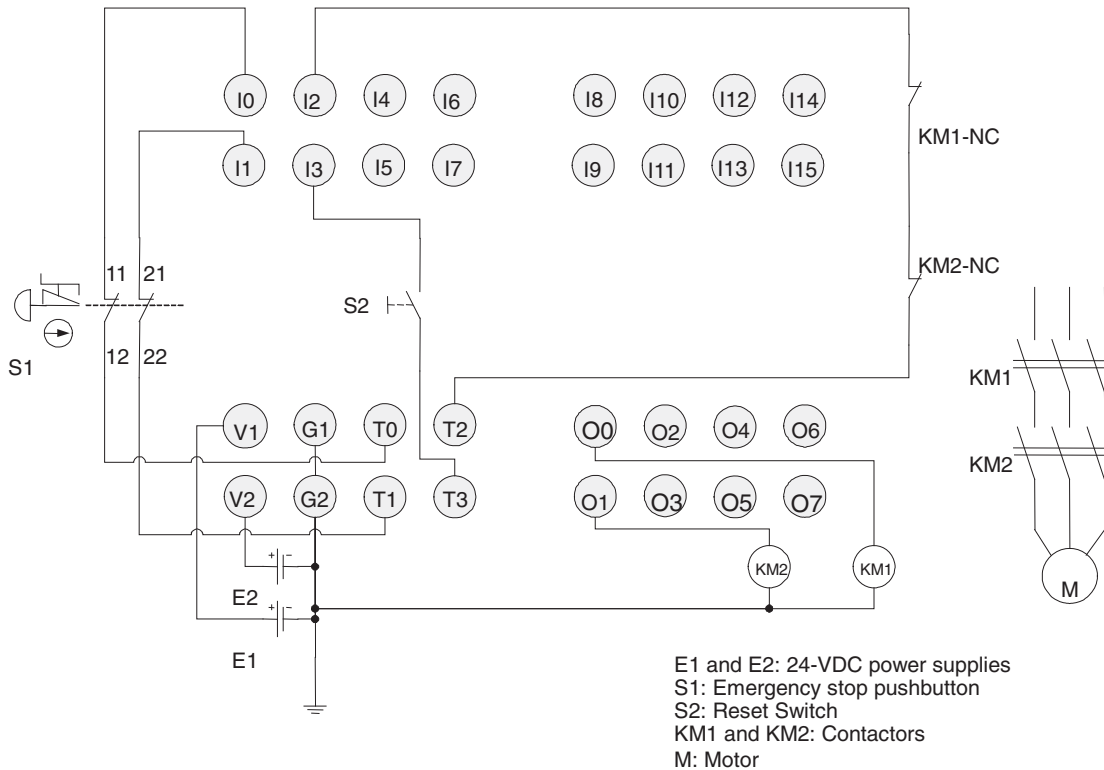

- Note**
- (1) Connect a 24-VDC power supply to terminals V0 and G0 (power supply terminals for internal circuits).
 - (2) This example shows the terminal layout for an NE1A-SCPU01(-V1) or NE1A-SCPU01-EIP Controller.

Timing Diagram

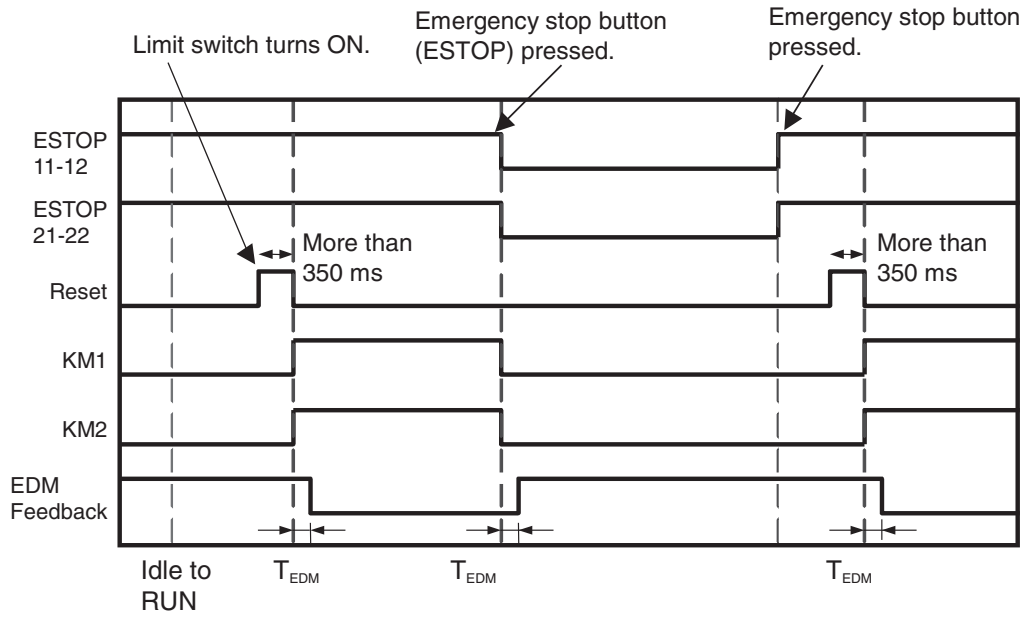

Programming Example

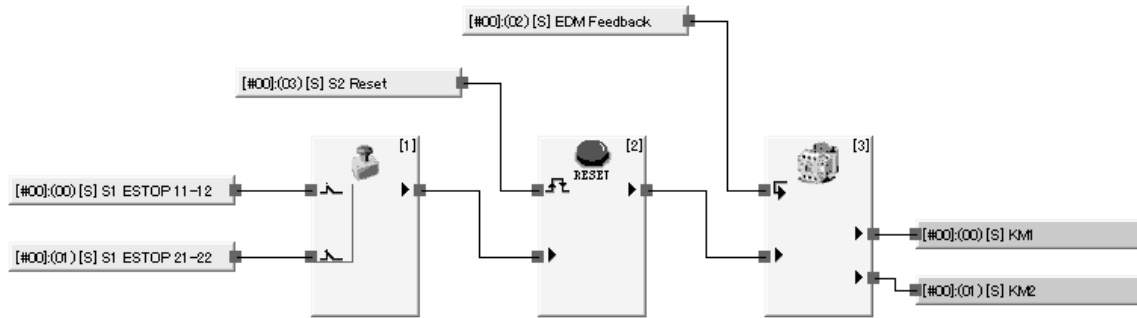

Local Input and Test Output Setting Example

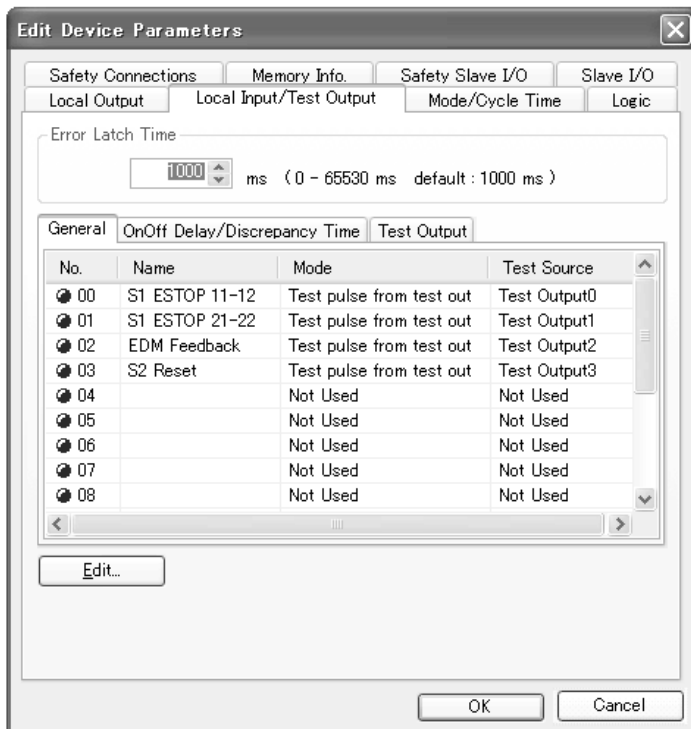

Local Output Setting Example

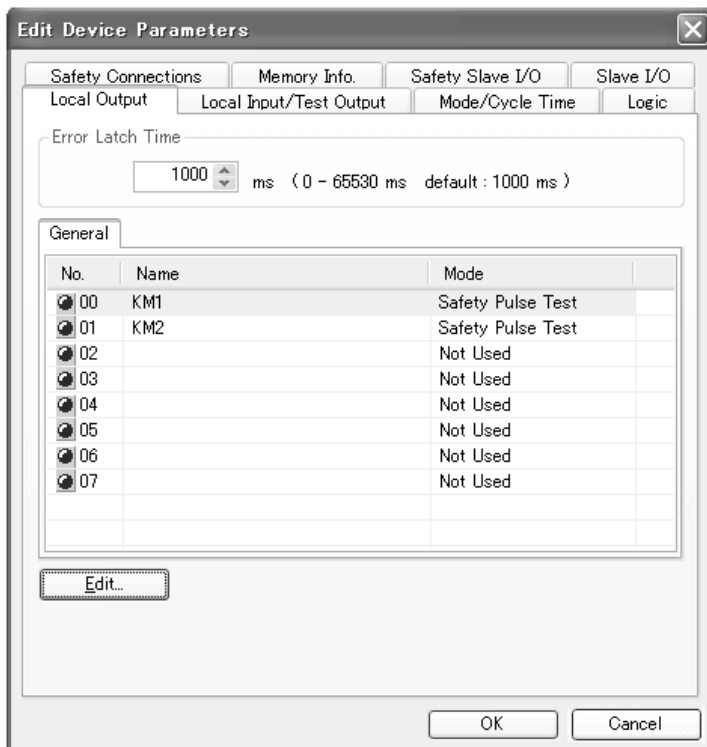

A-1-2 Safety Gate Application (1)

Safety category	Safety detection device	Stop category	Reset method
Equivalent to 4	Safety limit switch	0	Auto reset

Wiring Example

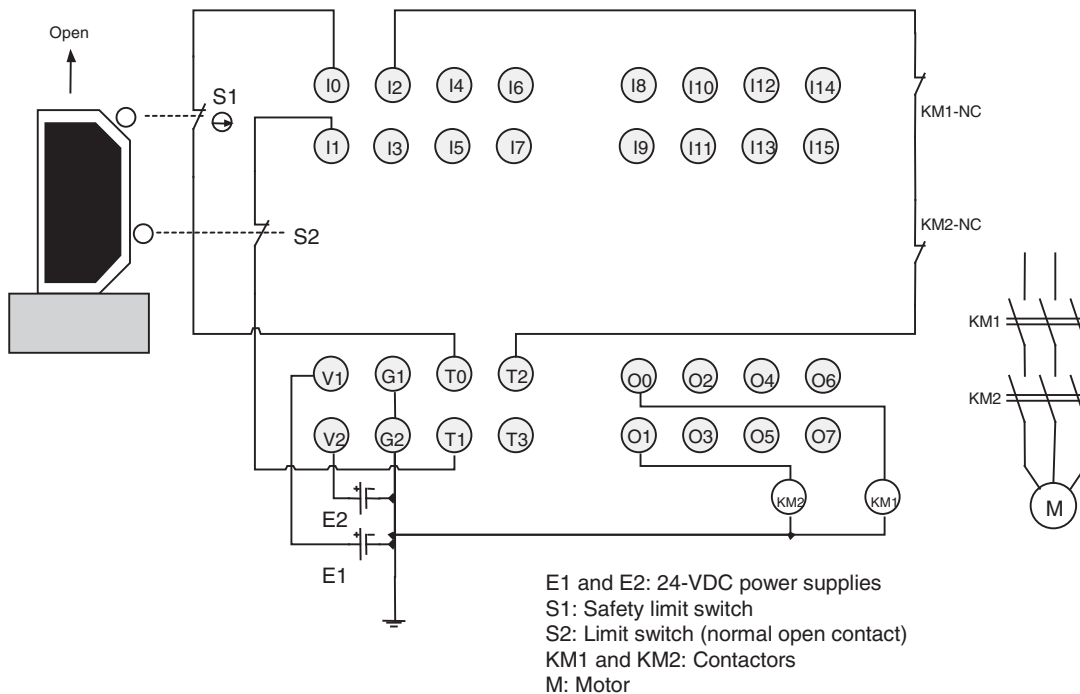

- Note**
- (1) Connect a 24-VDC power supply to terminals V0 and G0 (power supply terminals for internal circuits).
 - (2) This example shows the terminal layout for an NE1A-SCPU01(-V1) or NE1A-SCPU01-EIP Controller.

Timing Diagram

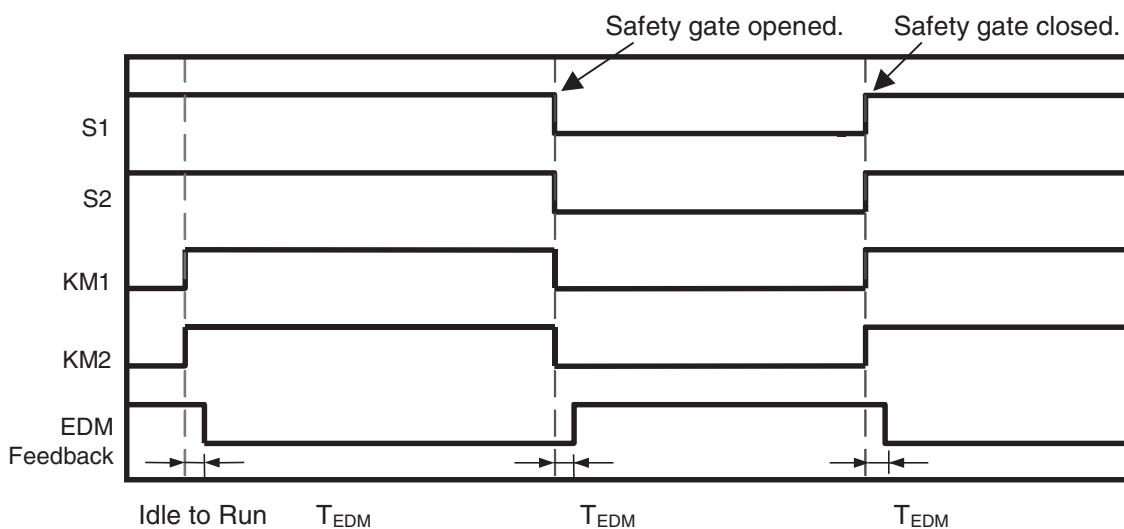

Programming Example

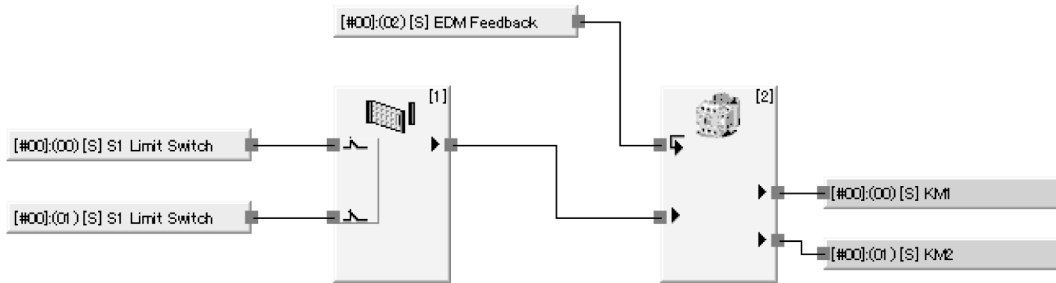

Local Input and Test Output Setting Example

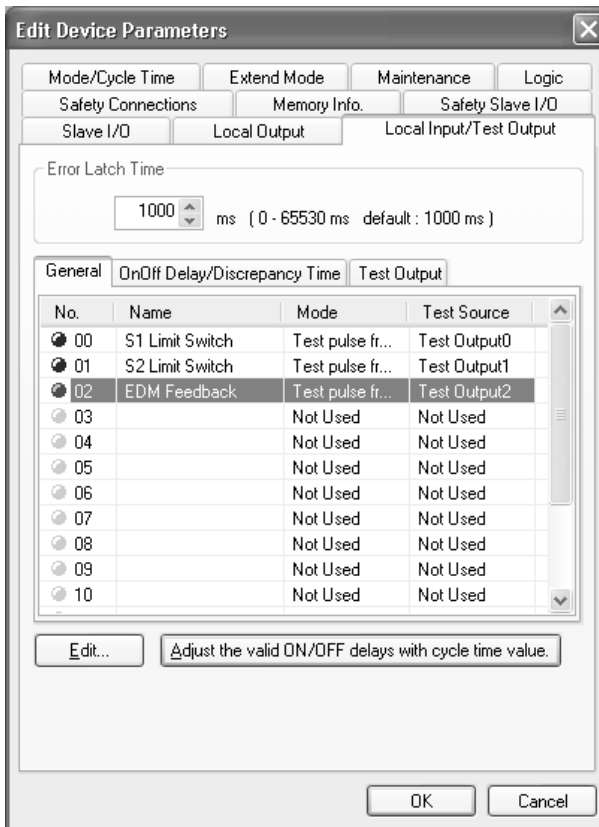

Local Output Setting Example

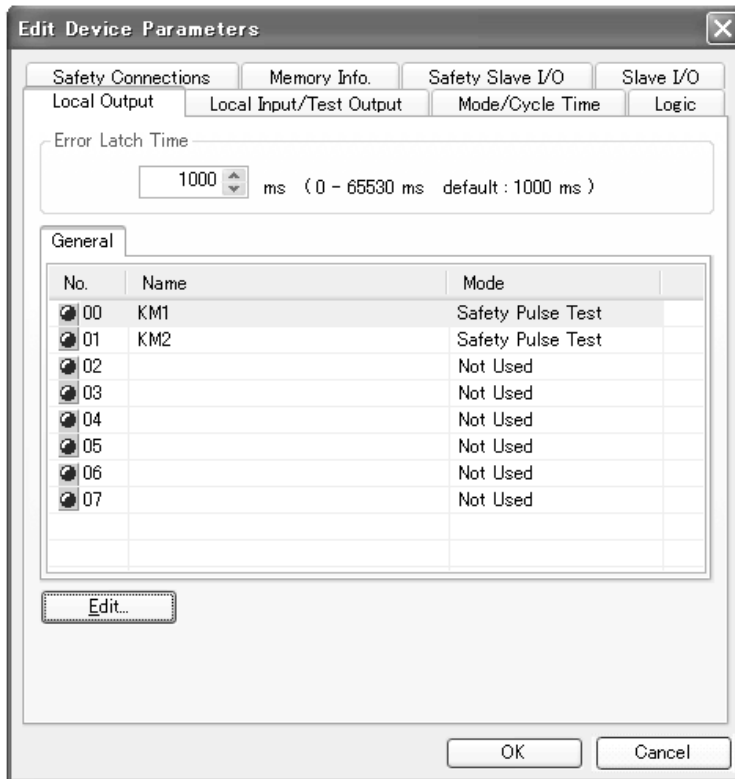

A-1-3 Safety Gate Application (2)

Safety category	Safety detection device	Stop category	Reset method
Equivalent to 4	Safety limit switch	0	Auto reset
	Emergency stop push-button	0	Manual

Wiring Example

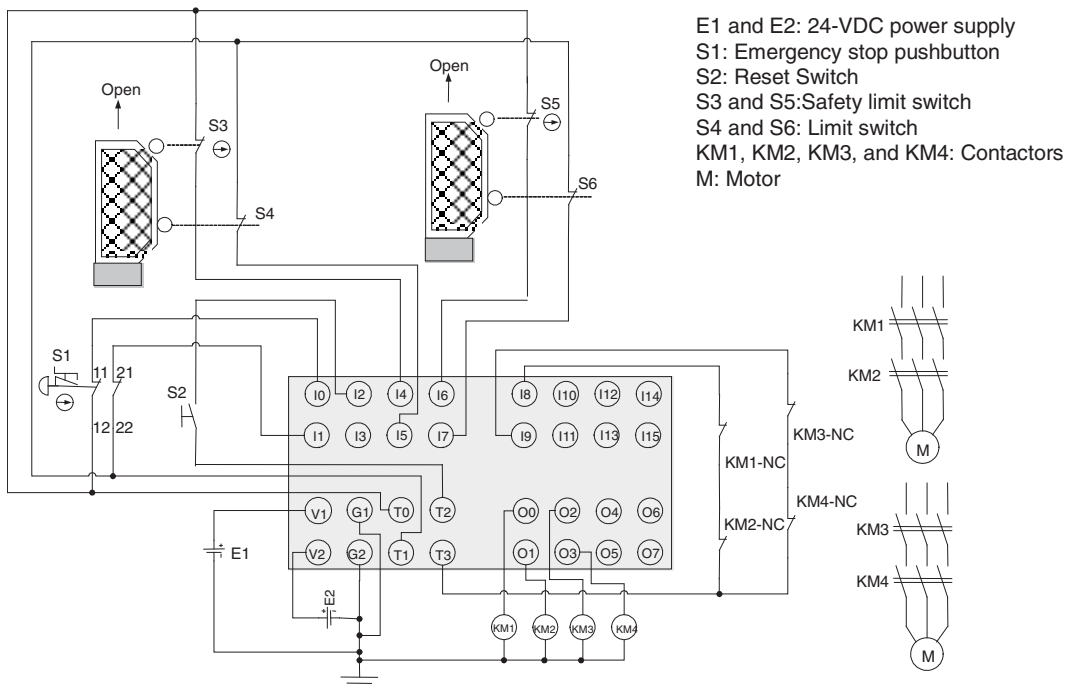

- Note**
- (1) Connect a 24-VDC power supply to terminals V0 and G0 (power supply terminals for internal circuits).
 - (2) This example shows the terminal layout for an NE1A-SCPU01(-V1) or NE1A-SCPU01-EIP Controller.

Timing Diagram

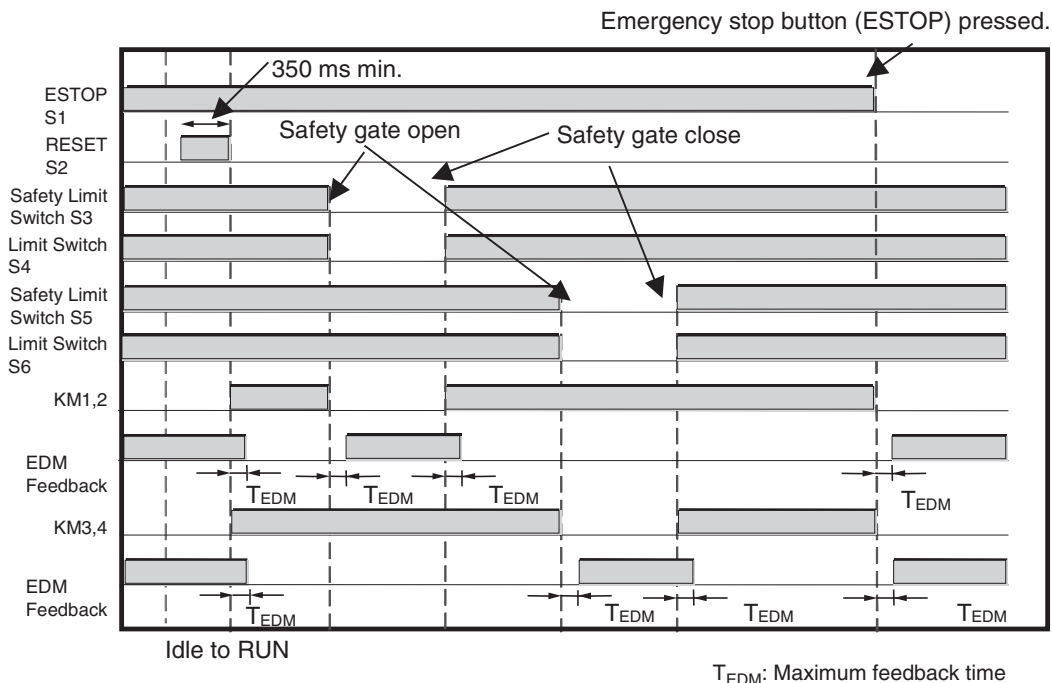

Programming Example

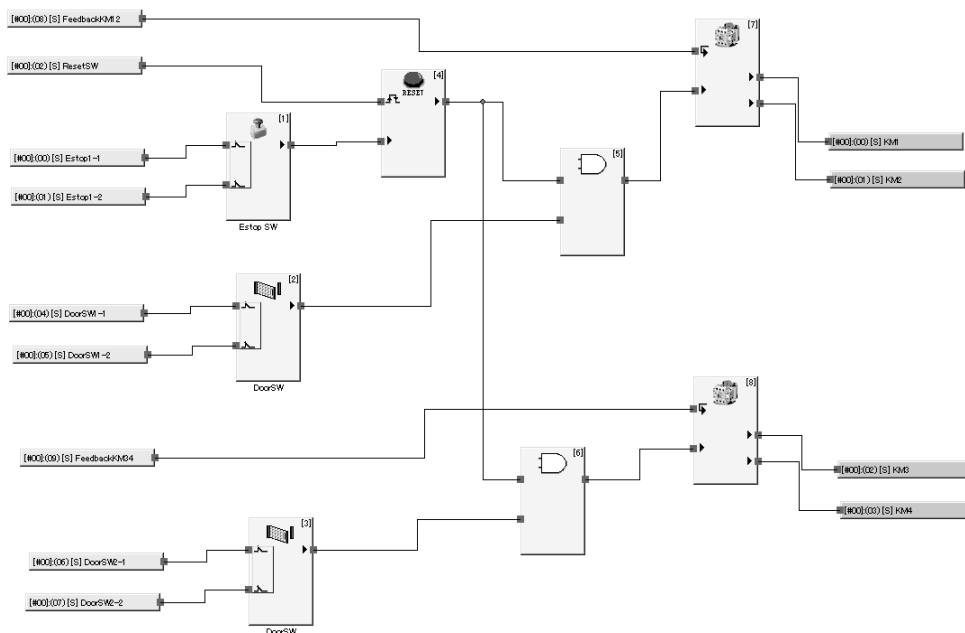

Local Input and Test Output Setting Example

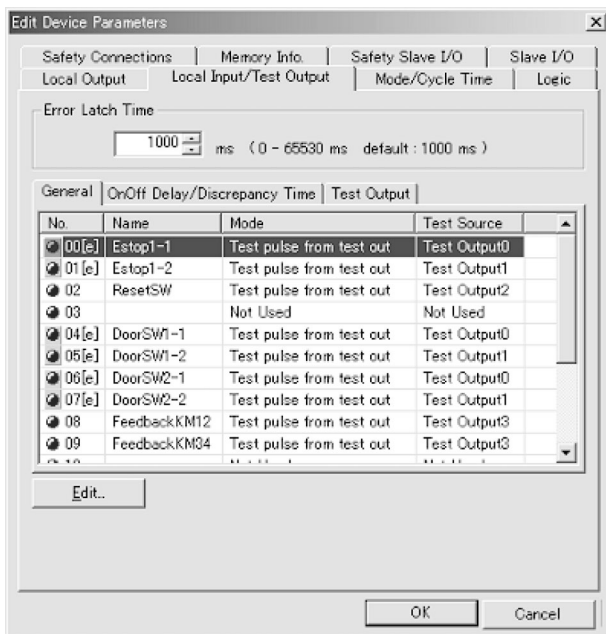

Local Output Setting Example

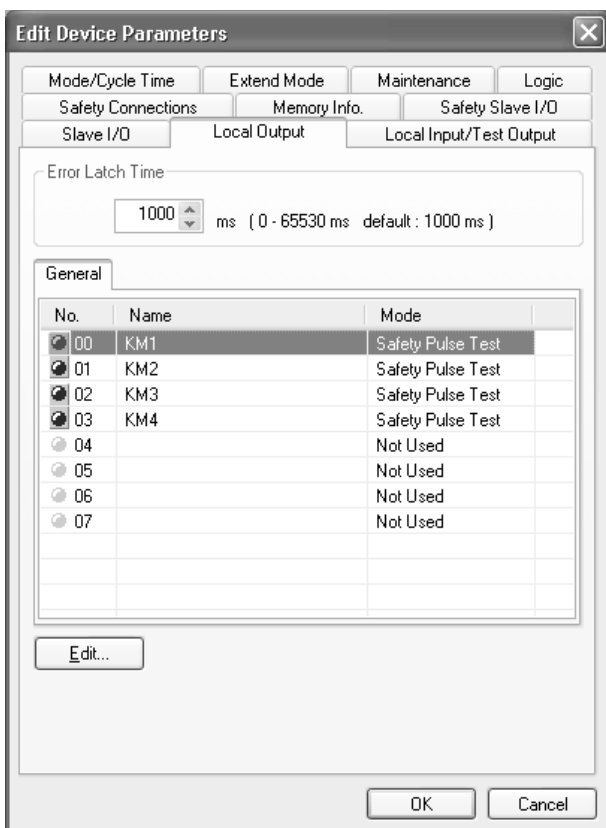

A-1-4 Safety Light Curtain Application

Safety category	Safety detection device	Stop category	Reset method
Equivalent to 4	<ul style="list-style-type: none"> Safety limit switch Emergency stop pushbutton 	0	Manual

Wiring Example

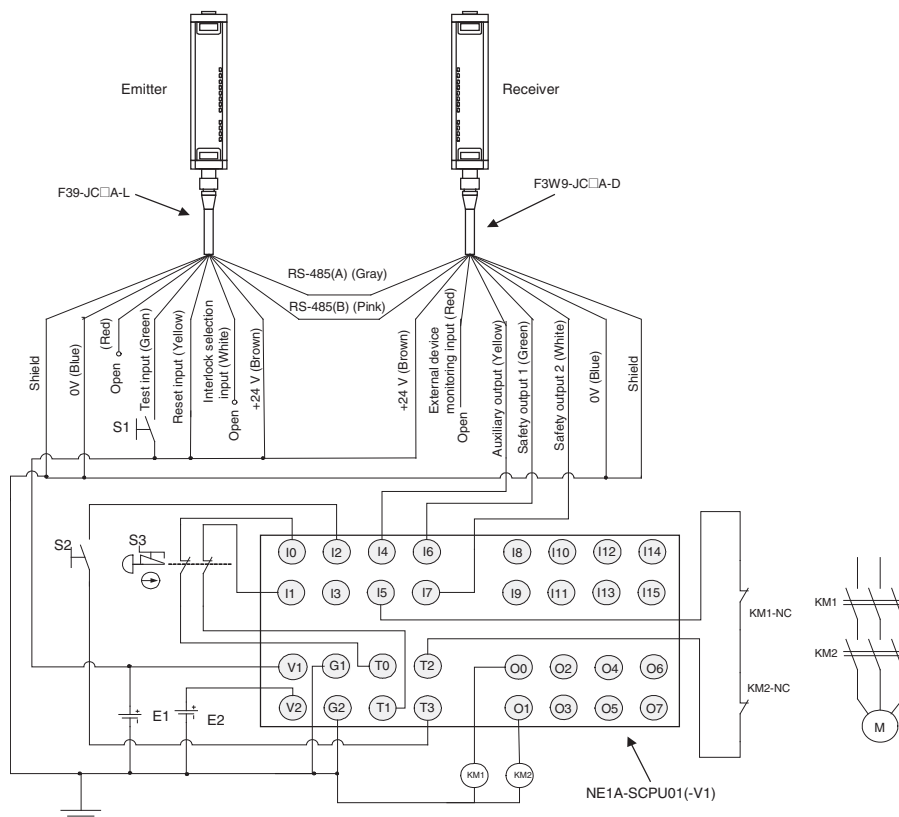

E1 and E2: 24-VDC power supply

S1: Reset switch

S2: Reset switch

S3: Emergency stop pushbutton

KM1 and KM2: Contactors

M: Motor

- Note**
- (1) Connect a 24-VDC power supply to terminals V0 and G0 (power supply terminals for internal circuits).
 - (2) This example shows the terminal layout for an NE1A-SCPU01(-V1) or NE1A-SCPU01-EIP Controller.

Timing Diagram

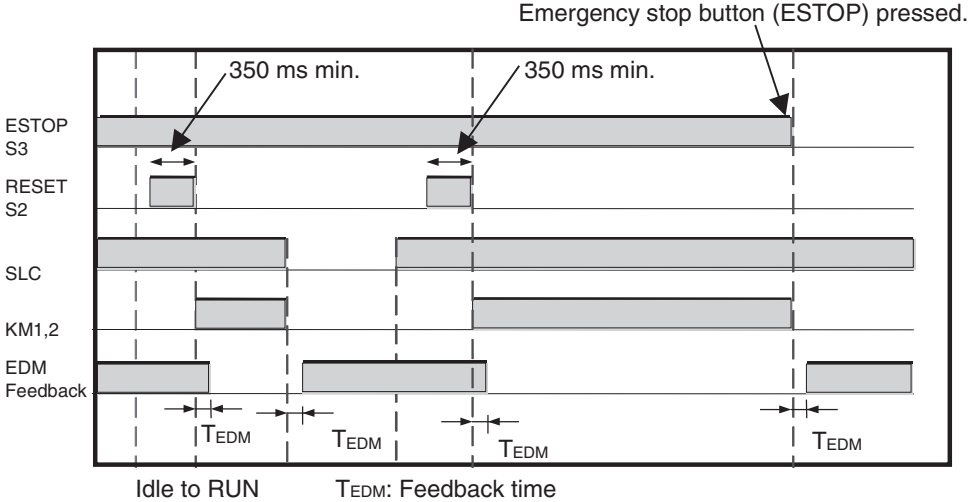

Programming Example

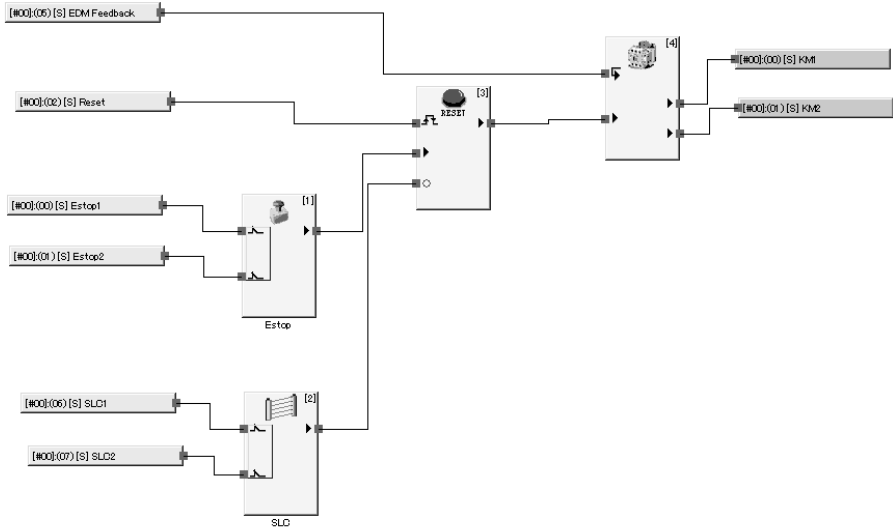

Local Input and Test Output Setting Example

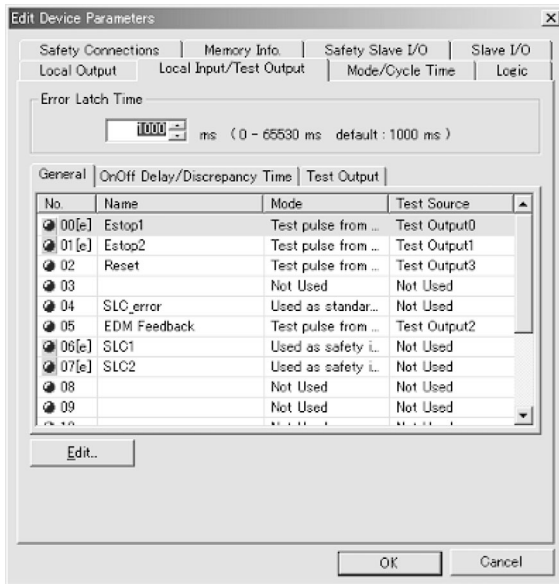

Local Output Setting Example

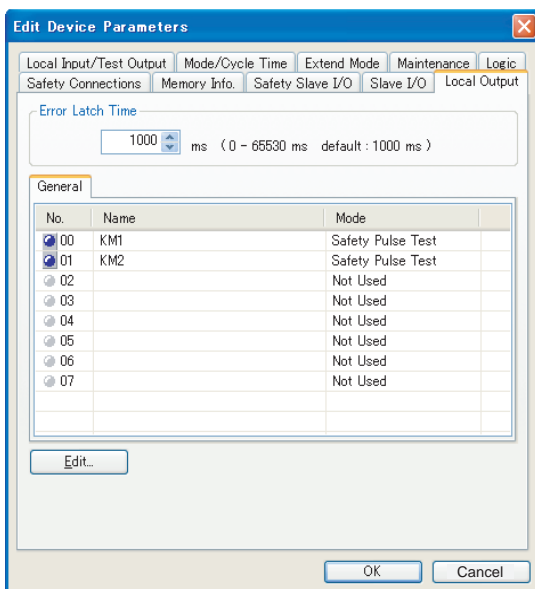

A-1-5 Safety Mat Application

Safety category	Safety detection device	Stop category	Reset method
Equivalent to 3	<ul style="list-style-type: none"> Safety mat Emergency stop pushbutton 	0	Manual

Wiring Example

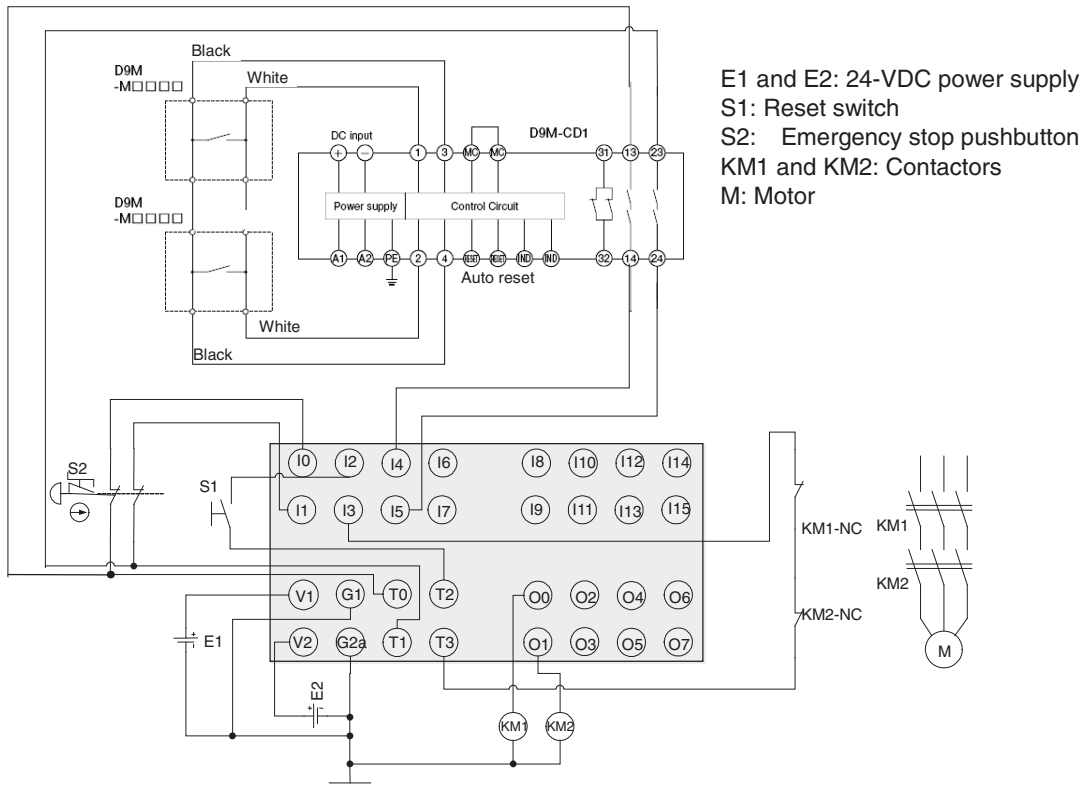

- Note**
- (1) Connect a 24-VDC power supply to terminals V0 and G0 (power supply terminals for internal circuits).
 - (2) This example shows the terminal layout for an NE1A-SCPU01(-V1) or NE1A-SCPU01-EIP Controller.

Timing Diagram

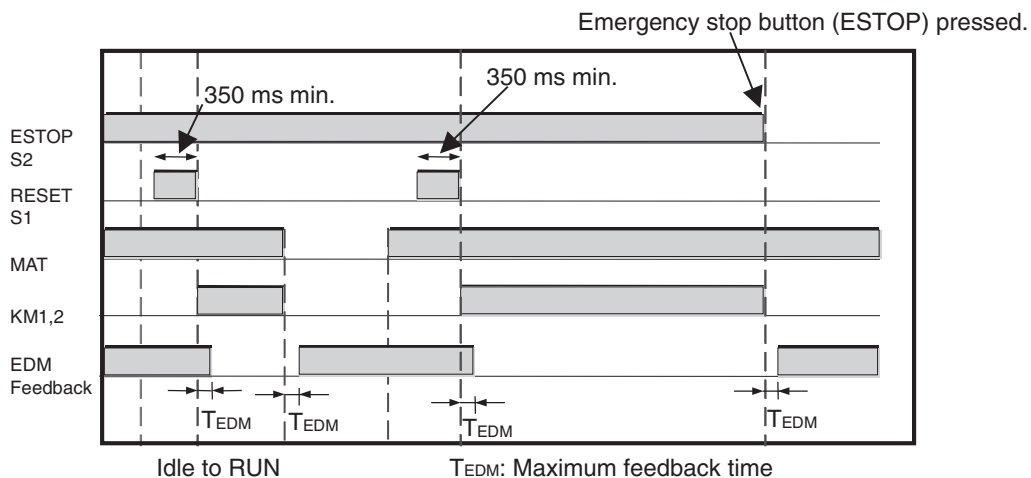

Programming Example

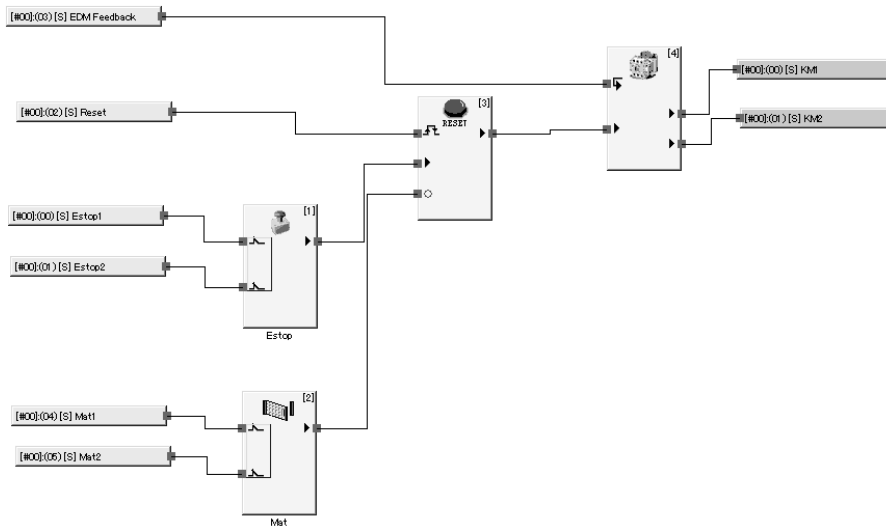

Local Input and Test Output Setting Example

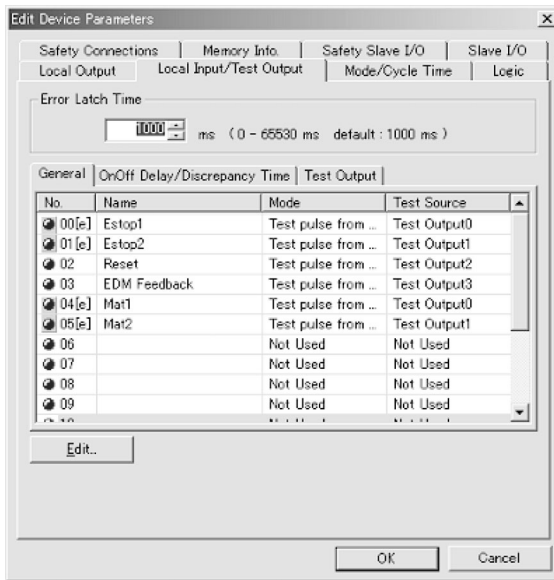

Local Output Setting Example

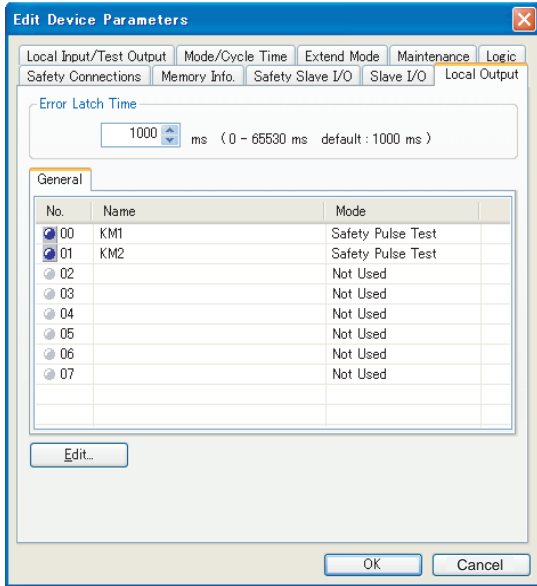

Appendix 2: Calculated Values of PFD and PFH

Calculated values of PFD and PFH for the NE1A-series Controller are given in the following tables. These values must be calculated for the overall devices within the system to comply with the SIL required for application.

A-2-1 Calculated PFD Values

Model	Proof test interval (years)	PFD
NE1A-SCPU01(-V1) NE1A-SCPU01-EIP	0.25	4.68E-07
	0.5	9.32E-07
	1	1.86E-06
	2	3.72E-06
NE1A-SCPU02 NE1A-SCPU02-EIP	0.25	5.90E-07
	0.5	1.17E-07
	1	2.34E-06
	2	4.68E-06

A-2-2 Calculated PFH Values

Model	PFH
NE1A-SCPU01(-V1) NE1A-SCPU01-EIP	4.25E-10
NE1A-SCPU02 NE1A-SCPU02-EIP	5.39E-10

Appendix 3: Explicit Messages

User-specified NE1A parameters can be read and written by sending explicit messages to the NE1A-series Controller. The NE1A-series Controller will process the received messages and return responses. This appendix describes the messages that are supported by the NE1A-series Controller.

A-3-1 Explicit Messages: NE1A-SCPU01-V1/NE1A-SCPU01-EIP

Reading General Status

Explicit message	Service	Function	Command					Response
			Service code	Class ID	Instance ID	Attribute ID	Data size	
Read Unit General Status	Read	Reads the Unit's general status.	0E hex	39 hex	01 hex	6E hex	---	1 byte

Reading I/O Area

Explicit message	Service	Function	Command					Response
			Service code	Class ID	Instance ID	Attribute ID	Data size	
Read I/O Area	Read	Reads the Unit's I/O data. Instance ID Specification Range: Local input = 01 Local output/test output = 02 Safety input = 05 Safety output = 06 Address Specification Range: Local input: 0 or 1 Local output/test output: 0 or 1 Safety input: 0 to 511 Safety output: 0 to 511	4B hex	306 hex	01, 02, 05, or 06 hex	---	First and second byte offset size: 0000 to 01FF hex (0 to 511), Third and fourth byte read size: 0001 to 0030 hex (1 to 48)	Read data

Setting and Monitoring Safety Input Terminals

Explicit message	Service	Function	Command					Response
			Service code	Class ID	Instance ID	Attribute ID	Data size	
Monitor Mode for Terminal Maintenance Information	Read	Reads the monitor mode of maintenance information for the input (1 to 16) specified by the Instance ID.	0E hex	3D hex	01 to 10 hex	65 hex	---	1 byte 00 hex: Total ON time mode 01 hex: Contact operation counter mode
	Write	Writes the monitor mode of maintenance information for the input (1 to 16) specified by the Instance ID.	10 hex	3D hex	01 to 10 hex	65 hex	1 byte 00 hex: Total ON time mode 01 hex: Contact operation counter mode	---
SV for Input Total ON Time or Contact Operation Counter	Read	Reads the SV of the total ON time (unit: seconds) or contact operation counter (unit: operations) for the input (1 to 16) specified by the Instance ID.	0E hex	3D hex	01 to 10 hex	68 hex	---	4 bytes 0000 0000 to FFFF FFFF hex (0 to 4,294,967,295)
	Write	Writes the SV of the total ON time (unit: seconds) or contact operation counter (unit: operations) for the input (1 to 16) specified by the Instance ID.	10 hex	3D hex	01 to 10 hex	68 hex	4 bytes 0000 0000 to FFFF FFFF hex (0 to 4,294,967,295)	---
Read Input Total ON Time or Contact Operation Counter	Read	Reads the total ON time (unit: seconds) or contact operation counter (unit: operations) for the input (1 to 16) specified by the Instance ID.	0E hex	3D hex	01 to 10 hex	66 hex	---	4 bytes 0000 0000 to FFFF FFFF hex (0 to 4,294,967,295)
Reset Input Total ON Time or Contact Operation Counter	Reset	Resets to 0 the total ON time (unit: seconds) or contact operation counter (unit: operations) for the input (1 to 16) specified by the Instance ID.	05 hex	3D hex	01 to 10 hex	66 hex	---	---
Read Monitor Status of Input Total ON Time or Contact Operation Counter	Read	Reads the monitor status of the total ON time or contact operation counter for the input (1 to 16) specified by the Instance ID.	0E hex	3D hex	01 to 10 hex	67 hex	---	1 byte 00 hex: In range 01 hex: Out of range (over monitor value)
Read Safety Input Normal Flag	Read	Reads the normal flag status of the number (1 to 16) specified by the Instance ID.	0E hex	3D hex	01 to 10 hex	04 hex	---	1 byte 00 hex: Error 01 hex: Normal
Read Safety Input Error Information Cause	Read	Reads the cause for the normal flag of the number (1 to 16) specified by the Instance ID being OFF (error).	0E hex	3D hex	01 to 10 hex	6E hex	---	1 byte 00 hex: No error 01 hex: Invalid configuration 02 hex: Test signal error 03 hex: Internal circuit error 04 hex: Discrepancy error 05 hex: Error in other channel of dual channels
Read AND of Safety Input Normal Flags	Read	Reads the logical AND of the normal flag status for all inputs 1 to 16.	0E hex	3E hex	01 hex	05 hex	---	1 byte 00 hex: Error 01 hex: All normal
Read OR of Monitor Status of Input Total ON Times or Contact Operation Counters	Read	Reads the logical OR of the monitor status of the total ON time or contact operation counter for all inputs 1 to 16.	0E hex	3E hex	01 hex	72 hex	---	1 byte 00 hex: All in range 01 hex: Input out of range (over monitor value)

Setting and Monitoring Safety Output Terminals

Explicit message	Service	Function	Command					Response
			Service code	Class ID	Instance ID	Attribute ID	Data size	
Monitor Mode for Terminal Maintenance Information	Read	Reads the monitor mode of maintenance information for the output (1 to 8) specified by the Instance ID.	0E hex	3B hex	01 to 08 hex	65 hex	---	1 byte 00 hex: Total ON time mode 01 hex: Contact operation counter mode
	Write	Writes the monitor mode of maintenance information for the output (1 to 8) specified by the Instance ID.	10 hex	3B hex	01 to 08 hex	65 hex	1 byte 00 hex: Total ON time mode 01 hex: Contact operation counter mode	---
SV for Output Total ON Time or Contact Operation Counter	Read	Reads the SV of the total ON time (unit: seconds) or contact operation counter (unit: operations) for the input (1 to 8) specified by the Instance ID.	0E hex	3B hex	01 to 08 hex	68 hex	---	4 bytes 0000 0000 to FFFF FFFF hex (0 to 4,294,967,295)
	Write	Writes the SV of the total ON time (unit: seconds) or contact operation counter (unit: operations) for the input (1 to 8) specified by the Instance ID.	10 hex	3B hex	01 to 08 hex	68 hex	4 bytes 0000 0000 to FFFF FFFF hex (0 to 4,294,967,295)	---
Read Output Total ON Time or Contact Operation Counter	Read	Reads the total ON time (unit: seconds) or contact operation counter (unit: operations) for the input (1 to 8) specified by the Instance ID.	0E hex	3B hex	01 to 08 hex	66 hex	---	4 bytes 0000 0000 to FFFF FFFF hex (0 to 4,294,967,295)
Reset Output Total ON Time or Contact Operation Counter	Reset	Resets to 0 the total ON time (unit: seconds) or contact operation counter (unit: operations) for the output (1 to 8) specified by the Instance ID.	05 hex	3B hex	01 to 08 hex	66 hex	---	---
Read Monitor Status of Output Total ON Time or Contact Operation Counter	Read	Reads the monitor status of the total ON time or contact operation for the output (1 to 8) specified by the Instance ID.	0E hex	3B hex	01 to 08 hex	67 hex	---	1 byte 00 hex: In range 01 hex: Out of range (over monitor value)
Read Safety Output Normal Flag	Read	Reads the normal flag status of the number (1 to 8) specified by the Instance ID.	0E hex	3B hex	01 to 08 hex	05 hex	---	1 byte 00 hex: Error 01 hex: Normal
Read Safety Output Error Information Cause	Read	Reads the cause for the normal flag of the number (1 to 8) specified by the Instance ID being OFF (error).	0E hex	3B hex	01 to 08 hex	6E hex	---	1 byte 00 hex: No error 01 hex: Invalid configuration 02 hex: Overcurrent detection 03 hex: Short-circuit detection 04 hex: High constant error 05 hex: Error in other channel of dual channels 06 hex: Internal relay circuit error 07 hex: Relay error 08 hex: Data error between dual channel outputs 09 hex: Detection of short circuit between wires
Read AND of Safety Output a Normal Flags	Read	Reads the logical AND of all outputs 1 to 8.	0E hex	3C hex	01 hex	05 hex	---	1 byte 00 hex: Error 01 hex: All normal
Read OR of Monitor Status of Output Total ON Times or Contact Operation Counters	Read	Reads the logical OR of the monitor status of the total ON time or contact operation counter for all outputs 1 to 8.	0E hex	3C hex	01 hex	72 hex	---	1 byte 00 hex: All in range 01 hex: Output out of range (over monitor value)

Monitoring Test Output Terminals

Explicit message	Service	Function	Command					Response
			Service code	Class ID	Instance ID	Attribute ID	Data size	
Monitor Mode for Terminal Maintenance Information	Read	Reads the monitor mode of maintenance information of the test output (1 to 4) specified by the Instance ID.	0E hex	307 hex	01 to 04 hex	83 hex	---	1 byte 00 hex: Total ON time mode 01 hex: Contact operation counter mode
	Write	Writes the monitor mode of maintenance information of the test output (1 to 4) specified by the Instance ID.	10 hex	307 hex	01 to 04 hex	83 hex	1 byte 00 hex: Total ON time mode 01 hex: Contact operation counter mode	---
SV for Test Output Total ON Time or Contact Operation Counter	Read	Reads the SV of the total ON time (unit: seconds) or contact operation counter (unit: operations) for the input (1 to 4) specified by the Instance ID.	0E hex	307 hex	01 to 04 hex	86 hex	---	4 bytes 0000 0000 to FFFF FFFF hex (0 to 4,294,967,295)
	Write	Writes the SV of the total ON time (unit: seconds) or contact operation counter (unit: operations) for the input (1 to 4) specified by the Instance ID.	10 hex	307 hex	01 to 04 hex	86 hex	4 bytes 0000 0000 to FFFF FFFF hex (0 to 4,294,967,295)	---
Read Test Output Total ON Time or Contact Operation Counter	Read	Reads the total ON time (unit: seconds) or contact operation counter (unit: operations) for the input (1 to 16) specified by the Instance ID.	0E hex	307 hex	01 to 04 hex	84 hex	---	4 bytes 0000 0000 to FFFF FFFF hex (0 to 4,294,967,295)
Reset Test Output Total ON Time or Contact Operation Counter	Reset	Resets to 0 the total ON time (unit: seconds) or contact operation counter (unit: operations) for the test output (1 to 4) specified by the Instance ID.	05 hex	307 hex	01 to 04 hex	84 hex	---	---
Read Monitor Status of Test Output Total ON Time or Contact Operation Counter	Read	Reads the monitor status of the total ON time or contact operation counter of the test output (1 to 4) specified by the Instance ID.	0E hex	307 hex	01 to 04 hex	85 hex	---	1 byte 00 hex: In range 01 hex: Out of range (over monitor value)
Read Test Output Safety Flag	Read	Reads the normal flag status for the test output (1 to 4) specified by the Instance ID.	0E hex	307 hex	01 to 04 hex	68 hex	---	1 byte 00 hex: Normal 01 hex: Error
Read Test Output Error Information Cause	Read	Reads the cause for the normal flag of the test output (1 to 4) specified by the Instance ID being OFF (error).	0E hex	307 hex	01 to 04 hex	76 hex	---	1 byte 00 hex: No error 01 hex: Invalid configuration 02 hex: Overcurrent detection 05 hex: High constant error 06 hex: Undercurrent detection
Read OR of Test Output Safety Flags	Read	Reads the logical OR of the normal flag status for all test outputs 1 to 4.	0E hex	308 hex	01 hex	69 hex	---	1 byte 00 hex: All normal 01 hex: Error
Read OR of Monitor Status of Test Output Total ON Times or Contact Operation Counters	Read	Reads the logical OR of the monitor status of the total ON time or contact operation counter for all test outputs 1 to 4.	0E hex	308 hex	01 hex	72 hex	---	1 byte 00 hex: All in range 01 hex: Test output out of range (over monitor value)

Reading and Writing EtherNet/IP Target I/O Areas (NE1A-SCPU01-EIP (Unit Version 1.1 or Later))

Explicit message	Service	Function	Command					Response
			Service code	Class ID	Instance ID	Attribute ID	Data size	
EtherNet/IP Target I/O Area.	Read	Reads an EtherNet/IP target I/O area. Instance ID Specification Range: Output 1 area = 10 hex Output 2 area = 11 hex Input 1 area = 12 hex Input 2 area = 13 hex Address Specification Range: Output 1/Output 2: 0 to 15 Input 1/Input 2: 0 to 127	4B hex	306 hex	10 to 13 hex	---	First and second bytes Offset size: 0000 to 007F hex (0 to 127) Third and fourth bytes Read size: 0001 to 0080 hex (1 to 128)	Read data
	Write	Writes an EtherNet/IP target I/O area. Instance ID Specification Range: Output 1 area = 10 hex Output 2 area = 11 hex Address Specification Range: 0 to 15	4C hex	306 hex	10 to 11 hex	---	First and second bytes Offset size: 0000 to 000F hex (0 to 15) Third and fourth bytes Write size: 0001 to 0010 hex (1 to 16) Fifth byte and beyond Write data	---
	Write with Access Right	Writes an EtherNet/IP target I/O area with an access right. Instance ID Specification Range: Output 1 area = 10 hex Output 2 area = 11 hex Address Specification Range: 0 to 15	4D hex	306 hex	10 to 11 hex	---	First and second bytes Program number 0001 to FFFE hex (1 to 65534) Third and fourth bytes Offset size: 0000 to 000F hex (0 to 15) Fifth and sixth bytes Write size: 0001 to 0010 hex (1 to 16) Seventh byte and beyond Write data	---
EtherNet/IP Target I/O Area Access Right	Get	Acquires the access right. Instance ID Specification Range: Output 1 area = 10 hex Output 2 area = 11 hex	4E hex	306 hex	10 to 11 hex	---	First and second bytes Program number 0000 to FFFE hex (0 to 65534) Third and fourth bytes Access right monitor timer set value 0001 to 0258 hex (1 to 600)	---
	Update	Updates the access right monitor timer. Instance ID Specification Range: Output 1 area = 10 hex Output 2 area = 11 hex	4F hex	306 hex	10 to 11 hex	---	First and second bytes Program number 0001 to FFFE hex (1 to 65534)	---
	Release	Releases the access right. Instance ID Specification Range: Output 1 area = 10 hex Output 2 area = 11 hex	50 hex	306 hex	10 to 11 hex	---	First and second bytes Program number 0001 to FFFE hex (1 to 65534)	---

A-3-2 Explicit Messages: NE1A-SCPU02/NE1A-SCPU02-EIP

Reading General Status

Explicit message	Service	Function	Command					Response
			Service code	Class ID	Instance ID	Attribute ID	Data size	
Read Unit General Status	Read	Reads the Unit's general status.	0E hex	39 hex	01 hex	6E hex	---	1 byte

Reading I/O Area

Explicit message	Service	Function	Command					Response
			Service code	Class ID	Instance ID	Attribute ID	Data size	
Read I/O Area	Read	Reads the Unit's I/O data. Instance ID Specification Range: Local input = 01 Local output/test output = 02 Safety input = 05 Safety output = 06 Address Specification Range: Local input: 0 to 4 Local output/test output: 0 or 1 Safety input: 0 to 511 Safety output: 0 to 511	4B hex	306 hex	01, 02, 05, and 06 hex	---	First and second byte offset size: 0000 to 01FF hex (0 to 511), Third and fourth byte read size: 0001 to 0030 hex (1 to 48)	Read data

Setting and Monitoring Safety Input Terminals

Explicit message	Service	Function	Command					Response
			Service code	Class ID	Instance ID	Attribute ID	Data size	
Monitor Mode for Terminal Maintenance Information	Read	Reads the monitor mode of maintenance information for the input (1 to 40) specified by the Instance ID.	0E hex	3D hex	01 to 28 hex	65 hex	---	1 byte 00 hex: Total ON time mode 01 hex: Contact operation counter mode
	Write	Writes the monitor mode of maintenance information for the input (1 to 40) specified by the Instance ID.	10 hex	3D hex	01 to 28 hex	65 hex	1 byte 00 hex: Total ON time mode 01 hex: Contact operation counter mode	---
SV for Input Total ON Time or Contact Operation Counter	Read	Reads the SV of the total ON time (unit: seconds) or contact operation counter (unit: operations) for the input (1 to 40) specified by the Instance ID.	0E hex	3D hex	01 to 28 hex	68 hex	---	4 bytes 0000 0000 to FFFF FFFF hex (0 to 4,294,967,295)
	Write	Writes the SV of the total ON time (unit: seconds) or contact operation counter (unit: operations) for the input (1 to 40) specified by the Instance ID.	10 hex	3D hex	01 to 28 hex	68 hex	4 bytes 0000 0000 to FFFF FFFF hex (0 to 4,294,967,295)	---
Read Input Total ON Time or Contact Operation Counter	Read	Reads the total ON time (unit: seconds) or contact operation counter (unit: operations) for the input (1 to 40) specified by the Instance ID.	0E hex	3D hex	01 to 28 hex	66 hex	---	4 bytes 0000 0000 to FFFF FFFF hex (0 to 4,294,967,295)
Reset Input Total ON Time or Contact Operation Counter	Reset	Resets to 0 the total ON time (unit: seconds) or contact operation counter (unit: operations) for the input (1 to 40) specified by the Instance ID.	05 hex	3D hex	01 to 28 hex	66 hex	---	---
Read Monitor Status of Input Total ON Time or Contact Operation Counter	Read	Reads the monitor status of the total ON time or contact operation counter for the input (1 to 40) specified by the Instance ID.	0E hex	3D hex	01 to 28 hex	67 hex	---	1 byte 00 hex: In range 01 hex: Out of range (over monitor value)
Read Safety Input Normal Status	Read	Reads the normal flag status of the number (1 to 40) specified by the Instance ID.	0E hex	3D hex	01 to 28 hex	04 hex	---	1 byte 00 hex: Error 01 hex: Normal
Read Safety input Error Information Cause	Read	Reads the cause for the normal flag status of the number (1 to 40) specified by the Instance ID being OFF (error).	0E hex	3D hex	01 to 28 hex	6E hex	---	1 byte 00 hex: No error 01 hex: Invalid configuration 02 hex: Test signal error 03 hex: Internal circuit error 04 hex: Discrepancy error 05 hex: Error in other channel of dual channels
Read AND of Safety Input Normal Flags	Read	Reads the logical AND of the normal flag status for all inputs 1 to 40.	0E hex	3E hex	01 hex	05Hex	---	1 byte 00 hex: Error 01 hex: All normal
Read OR of Monitor Status of Input Total ON Times or Contact Operation Counters	Read	Reads the logical OR of the monitor status of the total ON time or contact operation counter for all inputs 1 to 40.	0EHex	3EHex	01 hex	72Hex	---	1 byte 00 hex: All in range 01 hex: Input out range (over monitor value)

Setting and Monitoring Safety Output Terminals

Explicit message	Service	Function	Command					Response
			Service code	Class ID	Instance ID	Attribute ID	Data size	
Monitor Mode for Terminal Maintenance Information	Read	Reads the monitor mode of maintenance information for the output (1 to 8) specified by the Instance ID.	0E hex	3B hex	01 to 08 hex	65 hex	---	1 byte 00 hex: Total ON time mode 01 hex: Contact operation counter mode
	Write	Writes the monitor mode of maintenance information for the output (1 to 8) specified by the Instance ID.	10 hex	3B hex	01 to 08 hex	65 hex	1 byte 00 hex: Total ON time mode 01 hex: Contact operation counter mode	---
SV for Output Total ON Time or Contact Operation Counter	Read	Reads the SV of the total ON time (unit: seconds) or contact operation counter (unit: operations) for the output (1 to 8) specified by the Instance ID.	0E hex	3B hex	01 to 08 hex	68 hex	---	4 bytes 0000 0000 to FFFF FFFF hex (0 to 4,294,967,295)
	Write	Writes the SV of the total ON time (unit: seconds) or contact operation counter (unit: operations) for the output (1 to 8) specified by the Instance ID.	10 hex	3B hex	01 to 08 hex	68 hex	4 bytes 0000 0000 to FFFF FFFF hex (0 to 4,294,967,295)	---
Read Output Total ON Time or Contact Operation Counter	Read	Reads the total ON time (unit: seconds) or contact operation counter (unit: operations) for the output (1 to 8) specified by the Instance ID.	0E hex	3B hex	01 to 08 hex	66 hex	---	4 bytes 0000 0000 to FFFF FFFF hex (0 to 4,294,967,295)
Reset Output Total ON Time or Contact Operation Counter	Reset	Resets to 0 the total ON time (unit: seconds) or contact operation counter (unit: operations) for the output (1 to 8) specified by the Instance ID.	05 hex	3B hex	01 to 08 hex	66 hex	---	---
Read Monitor Status of Output Total ON Time or Contact Operation Counter	Read	Reads the monitor status of the total ON time or contact operation of the number (1 to 8) specified by the Instance ID.	0E hex	3B hex	01 to 08 hex	67 hex	---	1 byte 00 hex: In range 01 hex: Out of range (over monitor value)
Read Safety Output Normal Flag	Read	Reads the normal flag status of the number (1 to 8) specified by the Instance ID.	0E hex	3B hex	01 to 08 hex	05 hex	---	1 byte 00 hex: Error 01 hex: Normal
Read Safety Output Error Information Cause	Read	Reads the cause for the normal flag status of the number (1 to 8) specified by the Instance ID being OFF (error).	0E hex	3B hex	01 to 08 hex	6E hex	---	1 byte 00 hex: No error 01 hex: Invalid configuration 02 hex: Overcurrent detection 03 hex: Short-circuit detection 04 hex: High constant error 05 hex: Error in other channel of dual channels 06 hex: Internal relay circuit error 07 hex: Relay error 08 hex: Data error between dual channel outputs 09 hex: Detection of short circuit between wires
Read AND of Safety Output Normal Flags	Read	Reads the logical AND of the normal flag status for all outputs 1 to 8.	0E hex	3C hex	01 hex	05 hex	---	1 byte 00 hex: Error 01 hex: All normal
Read OR of Monitor Status of Output Total ON Times or Contact Operation Counters	Read	Reads the logical OR of the monitor status of the total ON time or contact operation counter for all outputs 1 to 8.	0E hex	3C hex	01 hex	72 hex	---	1 byte 00 hex: All in range 01 hex: Output out of range (over monitor value)

Monitoring Test Output Terminals

Explicit message	Service	Function	Command					Response
			Service code	Class ID	Instance ID	Attribute ID	Data size	
Monitor Mode for Terminal Maintenance Information	Read	Reads the monitor mode of maintenance information for the test output (1 to 8) specified by the Instance ID.	0E hex	307 hex	01 to 08 hex	83 hex	---	1 byte 00 hex: Total ON time mode 01 hex: Contact operation counter mode
	Write	Writes the monitor mode of maintenance information for the test output (1 to 8) specified by the Instance ID.	10 hex	307 hex	01 to 08 hex	83 hex	1 byte 00 hex: Total ON time mode 01 hex: Contact operation counter mode	---
SV for Test Output Total ON Time or Contact Operation Counter	Read	Reads the SV of the total ON time (unit: seconds) or contact operation counter (unit: operations) for the test output (1 to 8) specified by the Instance ID.	0E hex	307 hex	01 to 08 hex	86 hex	---	4 bytes 0000 0000 to FFFF FFFF hex (0 to 4,294,967,295)
	Write	Writes the SV of the total ON time (unit: seconds) or contact operation counter (unit: operations) for the test output (1 to 8) specified by the Instance ID.	10 hex	307 hex	01 to 08 hex	86 hex	4 bytes 0000 0000 to FFFF FFFF hex (0 to 4,294,967,295)	---
Read Test Output for Total ON Time or Contact Operation Counter	Read	Reads the total ON time (unit: seconds) or contact operation counter (unit: operations) for the test output (1 to 8) specified by the Instance ID.	0E hex	307 hex	01 to 08 hex	84 hex	---	4 bytes 0000 0000 to FFFF FFFF hex (0 to 4,294,967,295)
Reset Test Output for Total ON Time or Contact Operation Counter	Reset	Resets to 0 the total ON time (unit: seconds) or contact operation counter (unit: operations) for the test output (1 to 8) specified by the Instance ID.	05 hex	307 hex	01 to 08 hex	84 hex	---	---
Read Monitor Status of Test Output Total ON Time or Contact Operation Counter	Read	Reads the monitor status of the total ON time or contact operation counter for the test output (1 to 8) specified by the Instance ID.	0E hex	307 hex	01 to 08 hex	85 hex	---	1 byte 00 hex: In range 01 hex: Out of range (over monitor value)
Read Test Output Normal Flag	Read	Reads the normal flag status for the test output (1 to 8) specified by the Instance ID.	0E hex	307 hex	01 to 08 hex	68 hex	---	1 byte 00 hex: Normal 01 hex: Error
Read Test Output Error Information Cause	Read	Reads the cause for the normal flag of the test output (1 to 8) specified by the Instance ID being OFF (error).	0E hex	307 hex	01 to 08 hex	76 hex	---	1 byte 00 hex: No error 01 hex: Invalid configuration 02 hex: Overcurrent detection 05 hex: High constant error 06 hex: Undercurrent detection
Read OR of Test Output Normal Flags	Read	Reads the normal flag status of all test outputs 1 to 8.	0E hex	308 hex	01 hex	69 hex	---	1 byte 00 hex: All normal 01 hex: Error
Read OR of Monitor Status of Test Output Total ON Times or Contact Operation Counters	Read	Reads the logical OR of the monitor status of total ON time or contact operation counter for all test outputs 1 to 8.	0E hex	308 hex	01 hex	72 hex	---	1 byte 00 hex: All in range 01 hex: Test output out of range (over monitor value)

Reading and Writing EtherNet/IP Target I/O Areas (NE1A-SCPU02-EIP (Unit Version 1.1 or Later))

Explicit message	Service	Function	Command					Response
			Service code	Class ID	Instance ID	Attribute ID	Data size	
EtherNet/IP Target I/O Area.	Read	Reads an EtherNet/IP target I/O area. Instance ID Specification Range: Output 1 area = 10 hex Output 2 area = 11 hex Input 1 area = 12 hex Input 2 area = 13 hex Address Specification Range: Output 1/Output 2: 0 to 15 Input 1/Input 2: 0 to 127	4B hex	306 hex	10 to 13 hex	---	First and second bytes Offset size: 0000 to 007F hex (0 to 127) Third and fourth bytes Read size: 0001 to 0080 hex (1 to 128)	Read data
	Write	Writes an EtherNet/IP target I/O area. Instance ID Specification Range: Output 1 area = 10 hex Output 2 area = 12 hex Address Specification Range: 0 to 15	4C hex	306 hex	10 to 11 hex	---	First and second bytes Offset size: 0000 to 000F hex (0 to 15) Third and fourth bytes Write size: 0001 to 0010 hex (1 to 16) Fifth byte and beyond Write data	---
	Write with Access Right	Writes an EtherNet/IP target I/O area with an access right. Instance ID Specification Range: Output 1 area = 10 hex Output 2 area = 11 hex Address Specification Range: 0 to 15	4D hex	306 hex	10 to 11 hex	---	First and second bytes Program number 0001 to FFFF hex (1 to 65534) Third and fourth bytes Offset size: 0000 to 000F hex (0 to 15) Fifth and sixth bytes Write size: 0001 to 0010 hex (1 to 16) Seventh byte and beyond Write data	---
EtherNet/IP Target I/O Area Access Right	Get	Acquires the access right. Instance ID Specification Range: Output 1 area = 10 hex Output 2 area = 11 hex	4E hex	306 hex	10 to 11 hex	---	First and second bytes Program number 0000 to FFFE hex (0 to 65534) Third and fourth bytes Access right monitor timer set value 0001 to 0258 hex (1 to 600)	---
	Update	Updates the access right monitor timer. Instance ID Specification Range: Output 1 area = 10 hex Output 2 area = 11 hex	4F hex	306 hex	10 to 11 hex	---	First and second bytes Program number 0001 to FFFE hex (1 to 65534)	---
	Release	Releases the access right. Instance ID Specification Range: Output 1 area = 10 hex Output 2 area = 11 hex	50 hex	306 hex	10 to 11 hex	---	First and second bytes Program number 0001 to FFFE hex (1 to 65534)	---

A-3-3 Explicit Messages: NE1A-SCPU01

Reading General Status

Explicit message	Service	Function	Command					Response
			Service code	Class ID	Instance ID	Attribute ID	Data size	
Read Unit General Status	Read	Reads the Unit's general status.	0E hex	39 hex	01 hex	6E hex	---	1 byte

Reading I/O Area

Explicit message	Service	Function	Command					Response
			Service code	Class ID	Instance ID	Attribute ID	Data size	
Read I/O Area	Read	Reads the Unit's I/O data. Instance ID Specification Range: Local input = 01 Local output/test output = 02 Safety input = 05 Safety output = 06 Address Specification Range: Local input: 0 or 1 Local output/test output: 0 or 1 Safety input: 0 to 511 Safety output: 0 to 511	4B hex	306 hex	01, 02, 05, and 06 hex	---	First and second byte offset size: 0000 to 01FF hex (0 to 511), Third and fourth byte read size: 0001 to 0030 hex (1 to 48)	Read data

Safety Input Terminal Settings and Monitors

Explicit message	Service	Function	Command					Response
			Service code	Class ID	Instance ID	Attribute ID	Data size	
Read Safety Input Normal Flag	Read	Reads the normal flag status of the number (1 to 16) specified by the Instance ID.	0E hex	3D hex	01 to 10 hex	04 hex	---	1 byte 00 hex: Error 01 hex: Normal
Read Safety input Error Information Cause	Read	Reads the cause for the normal flag of the number (1 to 16) specified by the Instance ID being OFF (error).	0E hex	3D hex	01 to 10 hex	6E hex	---	1 byte 00 hex: No error 01 hex: Invalid configuration 02 hex: Test signal error 03 hex: Internal circuit error 04 hex: Discrepancy error 05 hex: Error in other channel of dual channels
Read AND of Safety Input Normal Flags	Read	Reads the logical AND of the normal flag status for all inputs 1 to 16.	0E hex	3E hex	01 hex	05 hex	---	1 byte 00 hex: Error 01 hex: All normal

Setting and Monitoring Safety Output Terminals

Explicit message	Service	Function	Command					Response
			Service code	Class ID	Instance ID	Attribute ID	Data size	
Read Safety Output Normal Flag	Read	Reads the normal flag status of the number (1 to 8) specified by the Instance ID.	0E hex	3B hex	01 to 08 hex	05 hex	---	1 byte 00 hex: Error 01 hex: Normal
Read Safety Output Error Information Cause	Read	Reads the cause for the normal flag of the number (1 to 8) specified by the Instance ID being OFF.	0E hex	3B hex	01 to 08 hex	6E hex	---	1 byte 00 hex: No error 01 hex: Invalid configuration 02 hex: Overcurrent detection 03 hex: Short-circuit detection 04 hex: High constant error 05 hex: Error in other channel of dual channels 06 hex: Internal relay circuit error 07 hex: Relay error 08 hex: Data error between dual channel outputs 09 hex: Detection of short circuit between wires
Read AND of Safety Output Normal Flags	Read	Reads the logical AND of the normal flag status for all outputs 1 to 8.	0E hex	3C hex	01 hex	05 hex	---	1 byte 00 hex: Error 01 hex: All normal

Monitoring Test Output Terminals

Explicit message	Service	Function	Command					Response
			Service code	Class ID	Instance ID	Attribute ID	Data size	
Read Test Output Normal Flag	Read	Reads the normal flag status of the test output (1 to 4) specified by the Instance ID.	0E hex	307 hex	01 to 04 hex	68 hex	---	1 byte 00 hex: Normal 01 hex: Error
Read Test Output Error Information Cause	Read	Reads the cause for the normal flag of the test output (1 to 4) specified by the Instance ID being OFF (error).	0E hex	307 hex	01 to 04 hex	76 hex	---	1 byte 00 hex: No error 01 hex: Invalid configuration 02 hex: Overcurrent detection 05 hex: High constant error 06 hex: Undercurrent detection
Read OR of Test Output Normal Flags	Read	Reads the logical OR of the normal flag status for all outputs 1 to 4.	0E hex	308 hex	01 hex	69 hex	---	1 byte 00 hex: All normal 01 hex: Error

Appendix 4: Response Code Table

This appendix provides a table of the response code that shows the execution results of explicit message requests. The response codes for communications with devices on DeviceNet consist of the following codes.

- General Status Code (1 byte)
- Additional Status Code (1 byte)

The additional status code provides error details. It will be 0xFF when not used. If the additional status code is not 0xFF, refer to the manual of the device that returned the response for the meaning of the code. This table gives the general status codes that are defined in the CIP specifications that are provided by the ODVA.

CIP General Status Code

General Status Code (in hex)	Status Name	Description of Status
00	Success	Service was successfully performed by the object specified.
01	Connection failure	A connection related service failed along the connection path.
02	Resource unavailable	Resources needed for the object to perform the requested service were unavailable
03	Invalid parameter value	See Status Code 0x20, which is the preferred value to use for this condition.
04	Path segment error	The path segment identifier or the segment syntax was not understood by the processing node. Path processing shall stop when a path segment error is encountered.
05	Path destination unknown	The path is referencing an object class, instance or structure element that is not known or is not contained in the processing node. Path processing shall stop when a path destination unknown error is encountered.
06	Partial transfer	Only part of the expected data was transferred.
07	Connection lost	The messaging connection was lost.
08	Service not supported	The requested service was not implemented or was not defined for this Object Class/Instance.
09	Invalid attribute value	Invalid attribute data detected
0A	Attribute list error	An attribute in the Get_Attribute_List or Set_Attribute_List response has a non-zero status.
0B	Already in requested mode/state	The object is already in the mode/state being requested by the service
0C	Object state conflict	The object cannot perform the requested service in its current mode/state
0D	Object already exists	The requested instance of object to be created already exists.
0E	Attribute not settable	A request to modify a non-modifiable attribute was received.
0F	Privilege violation	A permission/privilege check failed
10	Device state conflict	The device's current mode/state prohibits the execution of the requested service.
11	Reply data too large	The data to be transmitted in the response buffer is larger than the allocated response Buffer
12	Fragmentation of a primitive value	The service specified an operation that is going to fragment a primitive data value, i.e. half a REAL data type.
13	Not enough data	The service did not supply enough data to perform the specified operation.
14	Attribute not supported	The attribute specified in the request is not supported
15	Too much data	The service supplied more data than was expected
16	Object does not exist	The object specified does not exist in the device.
17	Service fragmentation sequence not in progress	The fragmentation sequence for this service is not currently active for this data.
18	No stored attribute data	The attribute data of this object was not saved prior to the requested service.
19	Store operation failure	The attribute data of this object was not saved due to a failure during the attempt.
1A	Routing failure, request packet too large	The service request packet was too large for transmission on a network in the path to the destination. The routing device was forced to abort the service.
1B	Routing failure, response packet too large	The service response packet was too large for transmission on a network in the path from the destination. The routing device was forced to abort the service.
1C	Missing attribute list entry data	The service did not supply an attribute in a list of attributes that was needed by the service to perform the requested behavior.

General Status Code (in hex)	Status Name	Description of Status
1D	Invalid attribute value list	The service is returning the list of attributes supplied with status information for those attributes that were invalid.
1E	Embedded service error	An embedded service resulted in an error.
1F	Vendor specific error	A vendor specific error has been encountered. The Additional Code Field of the Error Response defines the particular error encountered. Use of this General Error Code should only be performed when none of the Error Codes presented in this table or within an Object Class definition accurately reflect the error.
20	Invalid parameter	A parameter associated with the request was invalid. This code is used when a parameter does not meet the requirements of this specification and/or the requirements defined in an Application Object Specification.
21	Write-once value or medium already written	An attempt was made to write to a write-once medium (e.g. WORM drive, PROM) that has already been written, or to modify a value that cannot be changed once established.
22	Invalid Reply Received	An invalid reply is received (e.g. reply service code does not match the request service code, or reply message is shorter than the minimum expected reply size). This status code can serve for other causes of invalid replies.
23	Buffer Overflow	The message received is larger than the receiving buffer can handle. The entire message was discarded.
24	Message Format Error	The format of the received message is not supported by the server.
25	Key Failure in path	The Key Segment that was included as the first segment in the path does not match the destination module. The object specific status shall indicate which part of the key check failed.
26	Path Size Invalid	The size of the path which was sent with the Service Request is either not large enough to allow the Request to be routed to an object or too much routing data was included.
27	Unexpected attribute in list	An attempt was made to set an attribute that is not able to be set at this time.
28	Invalid Member ID	The Member ID specified in the request does not exist in the specified Class/Instance/Attribute
29	Member not settable	A request to modify a non-modifiable member was received
2A	Group 2 only server general failure	This error code may only be reported by DeviceNet Group 2 Only servers with 4K or less code space and only in place of Service not supported, Attribute not supported and Attribute not settable.
2B	Unknown Modbus Error	A CIP to Modbus translator received an unknown Modbus Exception Code.
2C-2F		Reserved by CIP for future extensions
D0-FF	Reserved for Object Class and service errors	This range of error codes is to be used to indicate Object Class specific errors. Use of this range should only be performed when none of the Error Codes presented in this table accurately reflect the error that was encountered.

Appendix 5: Exclusive Control of Writing NE1A EtherNet/IP Target I/O Areas

A-5-1 Overview

With an NE1A-series CPU Unit with EtherNet/IP (unit version 1.1 or later), standard I/O communications targets can be set for EtherNet/IP to write EtherNet/IP standard I/O areas from explicit message clients without using a dedicated EtherNet/IP standard originator. Messages to control access are provided to exclusively control access when more than one client may attempt to write the same area.

If the EtherNet/IP standard I/O area is being used in communications with the EtherNet/IP standard originator, writing the I/O area will end in an error because I/O communications are given priority.

Overview of Access Control for EtherNet/IP Standard Output Areas

Explicit messages can be used to control access to the EtherNet/IP target I/O areas to prevent another computer or PLC from writing to the same area. The program number that was specified by the client is used to control the access right. You must manage the program numbers so that the same program number is not used by more than one client. For emergency control applications, such as for errors, special program numbers can be specified to enable writing areas without being restricted by access rights.

If the relevant area is not written within the access right monitor time after the access right is acquired, the access right will be released and the write data will be cleared to zeros as error processing.

Note You can write output areas in IDLE mode. The access right monitor time is measured.

However, errors are reflected in the 7-segment display, status, and error history, and errors can be cleared only in RUN mode.

A-5-2 Sequence for Writing with Exclusive Control

Exclusive control to write to an EtherNet/IP target output area is performed according to the following flowchart.

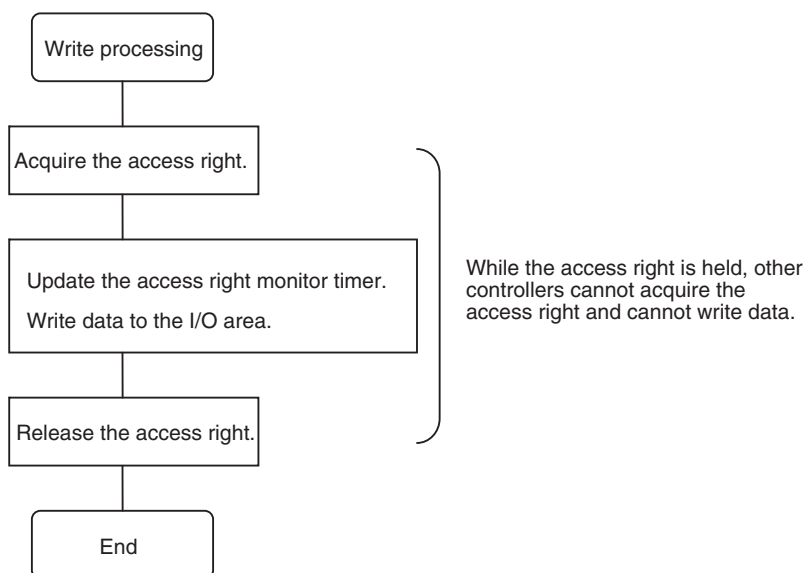

Processing to Get the Access Right

To enable exclusive control with the access right, a program number is registered in the NE1A-series Controller (CPU Unit with EtherNet/IP, unit version 1.1).

If another controller already holds the access right, it cannot be acquired.

A timeout monitor time is also registered in case there is no access from the controller for the specified period of time after the access right is acquired. If this process is finished normally, access from other controllers is prohibited.

Note If the program number is set to 0, the following operation occurs. Do not set the program number to 0 except for the specified applications.

- **Device Operation When Program Number Is Set to 0**
Exclusive access right control is not performed and only the timeout monitor timer operates.
This setting is used when intentionally allowing access from more than one controller or when there is no need for exclusive control because there is only one controller, but timeout monitor needs to be used.

Processing Updating the Access Right Monitor Timer

A request to update the access right monitor timer can be performed to enable continued use of exclusive access right control.

If data in the EtherNet/IP target I/O area is written within the monitor time, there is no need to perform an update request for the access right monitor timer.

Processing to Write Data to the I/O Area

Data is written to an EtherNet/IP target output area. Writing data to the specified area and updating the access right monitor timer are performed at the same time.

Note If the program number is set to FFFF hex, the following operation occurs. Do not set the program number to FFFF hex except for the specified application.

- **Device Operation When Program Number Is Set to FFFF Hex**
Data is written regardless of the current condition of the exclusive control of the access right.
Use this to write data regardless of access right control to force the Controller to stop during exclusive control for more than one Controller. Do not use this program number for any other application.

Processing to Release the Access Right

You can release the access right. The access right monitor timer will also stop.

Any data that has been written will remain, i.e., it will not be cleared for the access right monitor timer. Perform a write to clear data as required before you release the access right.

The access right is also released when the access right monitor timer times out. For a timeout, the write data is cleared as error processing.

A-5-3 Commands Used for Exclusive Writing Control

The message formats of the commands used to perform exclusive writing control are given below.

Get Access Right

This command acquires the access right for the output instances in EtherNet/IP target I/O areas for an NE1A-series Controller (CPU Unit with EtherNet/IP, unit version 1.1 or later).

The format of the explicit message is shown below.

Request Format

+0	Service code	1 byte
+1	Class ID	2 bytes
+3	Instance ID	2 bytes
+5	Program number	2 bytes
+7	Access right monitor timer set value	2 bytes

Parameter	Description
Service code	Specify 4E hex as the service code to acquire the access right.
Class ID	Specify 306 hex as the class ID.
Instance ID	For the instance ID, specify an EtherNet/IP target output area that was configured. The setting range is as follows: 10 hex: EtherNet/IP target output 1 area 11 hex: EtherNet/IP target output 2 area
Program number	The program number is used to acquire the access right and to specify the command to write I/O with the access right. The client device must manage the program numbers and can specify them as required. Setting range: 0001 to FFFE hex 0 (Access right time is monitored but exclusive control is not performed.)
Access right monitor timer set value	Set the time until timeout processing is started if there is no I/O write request for the EtherNet/IP target output area specified in the explicit message or if there is no update request for the access right monitor timer. The setting unit is 100 ms. If the timer times out, the specified output area is cleared to zeros. Setting range: 0 (default value: 10 s) 1 to 258 hex (100 ms to 60 s, unit: 100 ms)

Response Format

+0	Service code	1 byte
+1	Response code	2 bytes

Parameter	Description
Service code	The service code that was set when the request was sent (4E hex) is stored. For a normal response, the most-significant bit in the requested service code is turned ON. (Here, the value would be CE hex.) For an error response, 94 hex is stored.
Response code	The response data is stored. The following data is returned for an error response. <ul style="list-style-type: none"> • General Error Code (1 byte) • Additional Error Code (1 byte)

Error Response Code Details

General Error Code	Additional Error Code	Description
0C hex	FF hex	The access right is already held, so the request for the specified program number cannot be executed.
13 hex	FF hex	The request data is insufficient.
15 hex	FF hex	There is too much request data.
20 hex	FF hex	The specified instance number is out of range (i.e., not 10 or 11 hex). Or, the access right monitor timer set value exceeded 60 s.

Update Access Right Monitor Timer

This command updates the monitor timer for the access right that is currently held for the output instances in EtherNet/IP target I/O areas for an NE1A-series Controller (CPU Unit with EtherNet/IP, unit version 1.1 or later).

The format of the explicit message is shown below.

Request Format

+0	Service code	1 byte
+1	Class ID	2 bytes
+3	Instance ID	2 bytes
+5	Program number	2 bytes

Parameter	Description
Service code	Specify 4F hex as the service code to update the access right monitor timer.
Class ID	Specify 306 hex as the class ID.
Instance ID	For the instance ID, specify an EtherNet/IP target output area that was configured. The setting range is as follows: 10 hex: EtherNet/IP target output 1 area 11 hex: EtherNet/IP target output 2 area
Program number	Specify the program number that was specified when the access right was acquired.

Response Format

+0	Service code	1 byte
+1	Response code	2 bytes

Parameter	Description
Service code	The service code that was set when the request was sent (4F hex) is stored. For a normal response, the most-significant bit in the requested service code is turned ON. (Here, the value would be CF hex.) For an error response, 94 hex is stored.
Response code	The response data is stored. The following data is returned for an error response. <ul style="list-style-type: none"> • General Error Code (1 byte) • Additional Error Code (1 byte)

Error Response Code Details

General Error Code	Additional Error Code	Description
0C hex	FF hex	The specified program number does not agree with the program number of the currently held access right.
13 hex	FF hex	The request data is insufficient.
15 hex	FF hex	There is too much request data.
20 hex	FF hex	The specified instance number is out of range (i.e., not 10 or 11 hex).

Release Access Right

This command releases the access right that was acquired for the output instances in EtherNet/IP target I/O areas for an NE1A-series Controller (CPU Unit with EtherNet/IP, unit version 1.1 or later).

The format of the explicit message is shown below.

Request Format

+0	Service code	1 byte
+1	Class ID	2 bytes
+3	Instance ID	2 bytes
+5	Program number	2 bytes

Parameter	Description
Service code	Specify 50 hex as the service code to release the access right.
Class ID	Specify 306 hex as the class ID.
Instance ID	For the instance ID, specify an EtherNet/IP target output area that was configured. The setting range is as follows: 10 hex: EtherNet/IP target output 1 area 11 hex: EtherNet/IP target output 2 area
Program number	Specify the program number of the access right to release.

Response Format

+0	Service code	1 byte
+1	Response code	2 bytes

Parameter	Description
Service code	The service code that was set when the request was sent (50 hex) is stored. For a normal response, the most-significant bit in the requested service code is turned ON. (Here, the value would be D0 hex.) For an error response, 94 hex is stored.
Response code	The response data is stored. The following data is returned for an error response. <ul style="list-style-type: none"> • General Error Code (1 byte) • Additional Error Code (1 byte)

Error Response Code Details

General Error Code	Additional Error Code	Description
0C hex	FF hex	The specified program number does not agree with the program number of the currently held access right.
13 hex	FF hex	The request data is insufficient.
15 hex	FF hex	There is too much request data.
20 hex	FF hex	The specified instance number is out of range (i.e., not 10 or 11 hex).

Write EtherNet/IP Target I/O Area with Access Right

This command writes the output area for which the access right to the output instance in EtherNet/IP target I/O areas for an NE1A-series Controller (CPU Unit with EtherNet/IP, unit version 1.1 or later) is held. Only the client that holds the access right can write the output area.

The format of the explicit message is shown below.

Request Format

+0	Service code	1 byte
+1	Class ID	2 bytes
+3	Instance ID	2 bytes
+5	Program number	2 bytes
+7	Offset size	2 bytes
+9	Write data size	2 bytes
+11	Write data (for the specified write data size)	N bytes

Parameter	Description
Service code	Specify 4D hex as the service code to write.
Class ID	Specify 306 hex as the class ID.
Instance ID	For the instance ID, specify an EtherNet/IP target I/O area that was configured. The setting range is as follows: 10 hex: EtherNet/IP target output 1 area 11 hex: EtherNet/IP target output 2 area
Program number	Specify the program number that was specified when the access right was acquired. Writing is not possible unless the value matches the value used when the access right was set. A special program number (FFFF hex) can be specified to write even without the access right. Use this only in emergencies. Setting range: 0001 to FFFE hex 0000 (Writing is possible only when no access right is set.) FFFF hex (Writing is executed even if the access right is not held.)
Offset size	Set the offset of the byte at which to start writing. To start writing from the beginning of the I/O area, set the offset to 0.
Write data size	Specifies the number of bytes to write. The unit is bytes. The upper limit is the size of the EtherNet/IP target I/O area that is set. Setting range: 1 to 10 hex (1 to 16)
Write data	Store the amount of data specified for the write data size.

Response Format

+0	Service code	1 byte
+1	Response code	2 bytes

Parameter	Description
Service code	The service code that was set when the request was sent (4D hex) is stored. For a normal response, the most-significant bit in the requested service code is turned ON. (Here, the value would be CD hex.) For an error response, 94 hex is stored.
Response code	The response data is stored. The following data is returned for an error response. <ul style="list-style-type: none"> • General Error Code (1 byte) • Additional Error Code (1 byte)

Error Response Code Details

General Error Code	Additional Error Code	Description
0C hex	FF hex	There is no I/O data area configured for the specified instance.
0F hex	FF hex	The program number of the currently held access right and the specified program number do not match, so the write request cannot be executed.
10 hex	FF hex	The device is not in IDLE mode or RUN mode.
13 hex	FF hex	The request data is insufficient.
15 hex	FF hex	There is too much request data.
20 hex	FF hex	The data area is not configured for the specified write data size from the offset position. Or, the specified instance number is out of range (i.e., not 10 or 11 hex).

Appendix 6: UDP/IP Message Application Example

A-6-1 Overview

This appendix shows how to use message communications with UDP/IP frames from a general-purpose controller on Ethernet (PLC, computer, etc.) through NE1A-series Controllers to access NE1A-series Controllers or devices on DeviceNet Safety or DeviceNet networks. NE1A-series Controllers (CPU Units with EtherNet/IP, unit version 1.1 or later) are required.

Here, a programming example in which UDP/IP message communications from a Mitsubishi Electric CPU Module and Ethernet Interface Module on Ethernet are used to read and write an EtherNet/IP target output area in an NE1A-series Controller (CPU Unit with EtherNet/IP, unit version 1.1 or later) is provided.

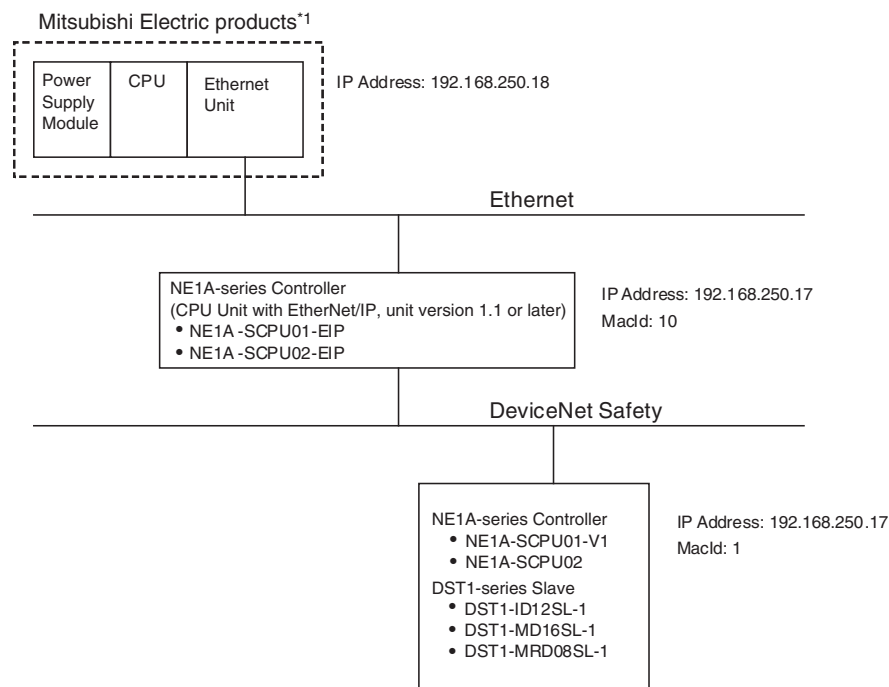

*1: The following Mitsubishi Electric products are used in this example.

Product	Model/version
Power Supply Module	Q61P
CPU Module	Q02HCPU
Ethernet Module	QJ71E71-100
Programming Software	GX Developer

A-6-2 Settings

The following settings are made for this example.

Mitsubishi Electric Ethernet Interface Module Settings

PLC Parameter Settings (Refer to *A-6-3 Mitsubishi Electric Ethernet Interface Module Settings*.)

- I/O Assignment Settings
- Program Settings

Network Parameter Settings (Refer to *A-6-3 Mitsubishi Electric Ethernet Interface Module Settings*.)

- Ethernet Operational Settings
- Initial Settings
- Open Settings

Creating the Ladder Program (Refer to A-6-4 Sample Ladder Programming.)

Note Refer to *Appendix 3: Explicit Messages* for detailed settings of the NE1A-series explicit messages.

A-6-3 Mitsubishi Electric Ethernet Interface Module Settings

This section describes the settings for the Mitsubishi Electric QJ71E71-100 Ethernet Interface Module.

Note Refer to the following manuals for actual setting procedures.

- QCPU User's Manual (Function Explanation, Program Fundamentals)
- Q Corresponding Ethernet Interface Module User's Manual (Basic)

PLC Parameter Settings

I/O Assignment Settings

These parameters set the Module models, I/O signal ranges, and other information for the Modules that are mounted on the Base Units.

This example uses the I/O assignment settings that are given in the following table.

Parameter	Description	Set value for this example
Type	Set the models of the mounted Modules.	Intelligent
Model name	Set the model names of the mounted Modules.	QJ71E71-100
Points	Set the number of points for each slot.	32
Start-XY (start I/O number)	Set the start I/O number for each slot.	0000

Program Settings

These parameters set the file name of the program and the execution type (execution condition).

This setting enables writing the program to the CPU Module.

The settings are shown below.

The following program settings are used in this example.

Parameter	Description	Set value for this example
Program name	Set the program name.	MAIN
Execution type	Set the execution type (execution condition).	Scan

Network Parameter Settings

This parameters set information to use the Ethernet Module as a Network Module.

Select **MELSECNET/Ethernet** from the Network Parameter Window and make the following settings.

Parameter	Description	Set value for this example
Network type	Select the mounted Module.	Ethernet
Starting I/O No.	Set the head address of the Module.	0000
Network No.	Set the network number of the Module.	1
Group No.	Set the group number of the Module.	1
Station No.	Set the station number of the Module.	1
Mode	Set the operation mode of the Module.	Online

Ethernet Operational Settings

These parameters set the common Module parameters to use the Ethernet Module.

This example uses the Ethernet operation settings that are given in the following table.

Parameter		Description	Set value for this example
Communication data code		Set the communications data code.	Binary code
Initial timing		Perform the setting for opening.	Do not wait for OPEN.
IP address	Input format	Set the IP address input format.	Decimal
	IP address	Set the IP address of the local station.	192.168.250.18
Send frame setting		Set the frame format to send.	Ethernet (V2.0)
TCP existence confirmation setting		Select the existence check method for TCP communications.	Use the KeepAlive

Initial Settings

These parameters set the common timer settings for TCP/IP communications and the DNS server settings for e-mail to use the Ethernet Module. This example uses the initial settings that are given in the following table.

Parameter	Description	Set value for this example
Response monitoring timer	Set the response wait time.	100

Open Settings

These parameters set the connection open processing and buffer memory application for fixed buffer communications to perform data communications with other devices.

This example uses the open settings that are given in the following table.

Parameter	Description	Set value for this example
Protocol	Set the communications protocol.	UDP
Fixed buffer ^{*1}	Set the usage of the fixed buffer.	This parameter is automatically set when the Pairing Open parameter is set to <i>Pairs</i> .
Fixed buffer communication ^{*1}	Select which protocol to use for fixed buffer communications.	No procedure
Pairing open ^{*1}	Select whether pairing open is used.	Pairs
Existence confirmation	Select whether to confirm the continued existence of a destination station.	Confirm
Local station port No.	Set the local station port number.	0401 hex
Destination IP address	Set the IP address of the remote device.	192.168.250.17 (NE1A-SCPU01-EIP, unit version 1.1 or later)
Dest. port No.	Set the port number of the remote device.	FA00 hex (= 64000 decimal)

*1: Always use the value given in the *Set value for this example* Column for these parameters.

A-6-4 Sample Ladder Programming

This section provides a programming example in which UDP/IP message communications from a Mitsubishi Electric CPU Module and Ethernet Interface Module on Ethernet are used to read and write an EtherNet/IP target output area in an NE1A-series Controller that supports EtherNet/IP with unit version 1.1 or later.

System Configuration

Ethernet Network

Device	IP address
Mistubishi Electric product	192.168.250.18
NE1A-series Controller (CPU Unit with EtherNet/IP, unit version 1.1 or later)	192.168.250.17

DeviceNet Network

Device	Node address
NE1A-series Controller (CPU Unit with EtherNet/IP, unit version 1.1 or later)	10

Overview of Processing in Sample Programming

The following processing is performed. (Refer to *A-6-6 Sample Ladder Programming Process Flowchart* for a processing flowchart.)

1. A connection is opened.
2. The access right to the EtherNet/IP target output area (instance 10) is acquired.
3. Data is written to the EtherNet/IP target output area (instance 10).
4. The access right monitor timer for the EtherNet/IP target output area (instance 10) is updated.
5. Data is read from the EtherNet/IP target output area (instance 10).
6. The connection is closed.

A-6-5 Memory Allocations

Memory in the CPU Module is allocated to the data that is used by the sample programming as shown in the following table.

Address	Contents	Remarks
D Area		
D100	Open execution type	
:		
D300	Entire data length for Get Access Right	Request message area for Get Access Right
D301	Message sequence number for Get Access Right	
D302	Timeout monitor time for Get Access Right	
D303	Request data length for Get Access Right	
D304	Node address and service code for Get Access Right	
D305	Class ID for Get Access Right	
D306	Instance ID for Get Access Right	
D307	Program number for Get Access Right	
D308	Access right monitor time for Get Access Right	
:		
D350	Receive data size for response to Get Access Right	Response message area for Get Access Right
D351	Message sequence number for response to Get Access Right	
D352	Data size for response to Get Access Right	

Address	Contents	Remarks
D353	Node address and response code for response to Get Access Right	
:		
D400	Entire data length for Write I/O	Request message area for Write I/O
D401	Message sequence number for Write I/O	
D402	Timeout monitor time for Write I/O	
D403	Request data length for Write I/O	
D404	Node address and service code for Write I/O	
D405	Class ID for Write I/O	
D406	Instance ID for Write I/O	
D407	Program number for Write I/O	
D408	Offset size for Write I/O	
D409	Write data size for Write I/O	
D410	Write data for Write I/O	
:		
D450	Receive data size for response to Write I/O	Response message area for Write I/O
D451	Message sequence number for response to Write I/O	
D452	Data size for response to Write I/O	
D453	Node address and response code for response to Write I/O	
:		
D500	Entire data length for Update Monitor Timer	Request message area for Update Monitor Timer
D501	Message sequence number for Update Monitor Timer	
D502	Timeout monitor time for Update Monitor Timer	
D503	Request data length for Update Monitor Timer	
D504	Node address and service code for Update Monitor Timer	
D505	Class ID for Update Monitor Timer	
D506	Instance ID for Update Monitor Timer	
D507	Program number for Update Monitor Timer	
:		
D550	Receive data size for response to Update Monitor Timer	Response message area for Update Monitor Timer
D551	Message sequence number for response to Update Monitor Timer	
D552	Data size for response to Update Monitor Timer	
D553	Node address and response code for response to Update Monitor Timer	
:		
D600	Entire data length for Release Access Right	Request area for Release Access Right
D601	Message sequence number for Release Access Right	
D602	Timeout monitor time for Release Access Right	
D603	Request data length for Release Access Right	
D604	Node address and service code for Release Access Right	
D605	Class ID for Release Access Right	
D606	Instance ID for Release Access Right	
D607	Program number for Release Access Right	
:		

Address	Contents	Remarks
D650	Receive data size for response to Release Access Right	Response area for Release Access Right
D651	Message sequence number for response to Release Access Right	
D652	Data size for response to Release Access Right	
D653	Node address and response code for response to Release Access Right	
:		
D700	Entire data length for Read I/O	Request area for Read I/O
D701	Message sequence number for Read I/O	
D702	Timeout monitor time for Read I/O	
D703	Request data length for Read I/O	
D704	Node address and service code for Read I/O	
D705	Class ID for Read I/O	
D706	Instance ID for Read I/O	
D707	Offset size for Read I/O	
D708	Read data size for Read I/O	
:		
D750	Receive data size for response to Read I/O	Response area for Read I/O
D751	Message sequence number for response to Read I/O	
D752	Data size for response to Read I/O	
D753	Node address and response code for response to Read I/O	
D754	Read data for response to Read I/O	
M Area		
M0	Connection 1 open completed signal	
:		
M20	Connection 1 open request signal	
:		
M40	Fixed buffer 1 reception status signal	
:		
M100	OPEN instruction completed flag	
M101	OPEN instruction error completion device	
:		
M110	Message send completed flag for Get Access Right	
M111	Message send error flag for Get Access Right	
M112	Message send normal flag for Get Access Right	
:		
M120	Message receive completed flag for response to Get Access Right	
M121	Message receive error flag for response to Get Access Right	
:		
M130	Message send completed flag for Write I/O	
M131	Message send error flag for Write I/O	
M132	Message send normal flag for Write I/O	
:		
M140	Message receive completed flag for response to Write I/O	

Address	Contents	Remarks
M141	Message receive error flag for response to Write I/O	
:		
M150	Message send completed flag for Update Monitor Timer	
M151	Message send error flag for Update Monitor Timer	
M152	Message send normal flag for Update Monitor Timer	
:		
M160	Message receive completed flag for response to Update Monitor Timer	
M161	Message receive error flag for response to Update Monitor Timer	
:		
M170	Message send completed flag for Release Access Right	
M171	Message send error flag for Release Access Right	
M172	Message send normal flag for Release Access Right	
:		
M180	Message receive completed flag for response to Release Access Right	
M181	Message receive error flag for response to Release Access Right	
:		
M190	Message send completed flag for Read I/O	
M191	Message send error flag for Read I/O	
M192	Message send normal flag for Read I/O	
:		
M200	Message receive completed flag for response to Read I/O	
M201	Message receive error flag for response to Read I/O	
:		
M210	CLOSE instruction completed flag	
M211	CLOSE instruction error flag	
M212	CLOSE instruction normal flag	
:		
M900	Communications error flag	
:		
M1000	OPEN command 1 PLS	
M1001	Request send command for Get Access Right	
M1002	Request send command for Write I/O	
M1003	Request send command for Update Monitor Timer	
M1004	Request send command for Release Access Right	
M1005	Request send command for Read I/O	
M1006	CLOSE command	
SM Area		
SM400	Always ON	
:		
SM402	ON one scan only after RUN	
T Area		

Address	Contents	Remarks
T1	Response wait timer for Get Access Right	
T2	Response wait timer for Write I/O	
T3	Response wait timer for Update Monitor Timer	
T4	Response wait timer for Release Access Right	
T5	Response wait timer for Read I/O	

A-6-6 Sample Ladder Programming Process Flowchart

A process flowchart for the sample programming is provided below.

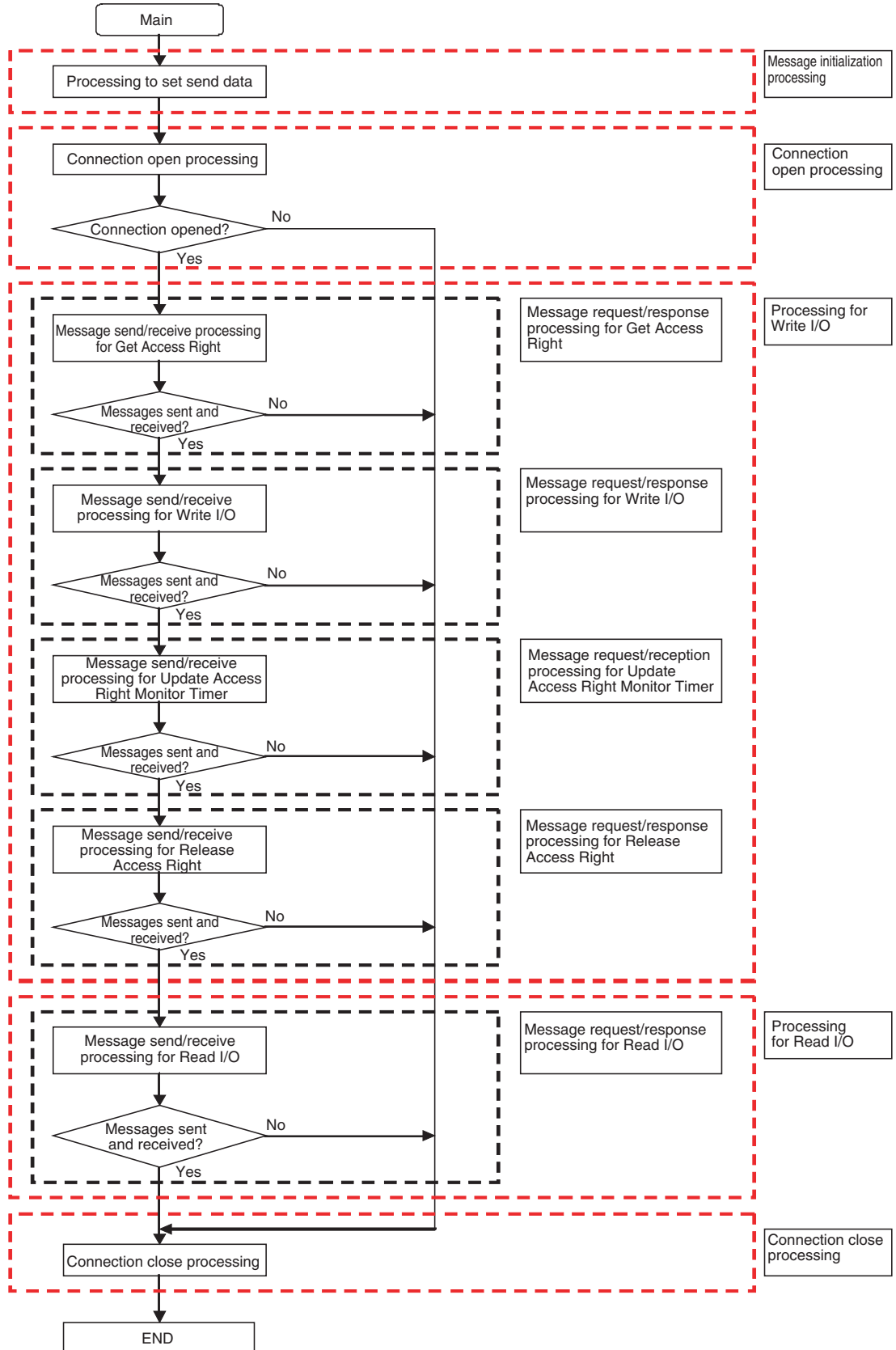

A-6-7 Explicit Message Used in the Sample Programming

The basic formats of the messages that are used in this sample are shown below.

Settings for Get Access Right Message

Request Message Contents

Item	Set value
Destination node address	0A hex
Service code	4E hex
Class ID	306 hex
Instance ID	10 hex
Request data	5555003C hex

Memory Map of Fixed Buffer

Send Data for Get Access Right Request Message

Address	15	8	7	0	Remarks
D300	00 hex		10 hex		Entire data length
D301	00 hex		00 hex		Message sequence number
D302	03 hex		E8 hex		Timeout monitor time
D303	00 hex		0A hex		Request data length
D304	4E hex		0A hex		Node address and service code
D305	03 hex		06 hex		Class ID
D306	00 hex		10 hex		Instance ID
D307	55 hex		55 hex		Program number
D308	00 hex		3C hex		Access right monitor time

Receive Data for Get Access Right Response Message

Address	15	8	7	0	Remarks
D350	00 hex		06 hex		Receive data size
D351	00 hex		00 hex		Message sequence number
D352	00 hex		02 hex		Data size
D353	CE hex		0A hex		Node address and service code

Settings for Write I/O Message

Request Message Contents

Item	Set value
Destination node address	0A hex
Service code	4D hex
Class ID	306 hex
Instance ID	10 hex
Request data	55550000002 AA55 hex

Memory Map of Fixed Buffer

Send Data for Write I/O Request Message

Address	15	8	7	0	Remarks
D400	00 hex		14 hex		Entire data length
D401	00 hex		01 hex		Message sequence number
D402	03 hex		E8 hex		Timeout monitor time
D403	00 hex		0E hex		Request data length
D404	4D hex		0A hex		Node address and service code

Address	15	8	7	0	Remarks
D405	03 hex		06 hex		Class ID
D406	00 hex		10 hex		Instance ID
D407	55 hex		55 hex		Program number
D408	00 hex		00 hex		Offset size
D409	00 hex		02 hex		Write data size
D410	AA hex		55 hex		Write data

Receive Data for Write I/O Response Message

Address	15	8	7	0	Remarks
D450	00 hex		06 hex		Receive data size
D451	00 hex		01 hex		Message sequence number
D452	00 hex		02 hex		Data size
D453	CD hex		0A hex		Node address and service code

Settings for Update Access Right Monitor Timer Message**Request Message Contents**

Item	Set value
Destination node address	0A hex
Service code	4F hex
Class ID	306 hex
Instance ID	10 hex
Request data	5555 hex

Memory Map of Fixed Buffer

Send Data for Update Access Right Monitor Timer Request Message

Address	15	8	7	0	Remarks
D500	00 hex		0E hex		Entire data length
D501	00 hex		02 hex		Message sequence number
D502	03 hex		E8 hex		Timeout monitor time
D503	00 hex		08 hex		Request data length
D504	4F hex		0A hex		Node address and service code
D505	03 hex		06 hex		Class ID
D506	00 hex		10 hex		Instance ID
D507	55 hex		55 hex		Program number

Receive Data for Update Access Right Monitor Timer Response Message

Address	15	8	7	0	Remarks
D550	00 hex		06 hex		Receive data size
D551	00 hex		02 hex		Message sequence number
D552	00 hex		02 hex		Data size
D553	CF hex		0A hex		Node address and service code

Settings for Release Access Right Message

Request Message Contents

Item	Set value
Destination node address	0A hex
Service code	50 hex
Class ID	306 hex
Instance ID	10 hex
Request data	5555 hex

Memory Map of Fixed Buffer

Send Data for Release Access Right Request Message

Address	15	8	7	0	Remarks
D600	00 hex		0E hex		Entire data length
D601	00 hex		03 hex		Message sequence number
D602	03 hex		E8 hex		Timeout monitor time
D603	00 hex		08 hex		Request data length
D604	50 hex		0A hex		Node address and service code
D605	03 hex		06 hex		Class ID
D606	00 hex		10 hex		Instance ID
D607	55 hex		55 hex		Program number

Receive Data for Release Access Right Response Message

Address	15	8	7	0	Remarks
D650	00 hex		06 hex		Receive data size
D651	00 hex		03 hex		Message sequence number
D652	00 hex		02 hex		Data size
D653	D0 hex		0A hex		Node address and service code

Settings for Read I/O Message

Request Message Contents

Item	Set value
Destination node address	0A hex
Service code	4B hex
Class ID	306 hex
Instance ID	10 hex
Request data	00000002 hex

Memory Map of Fixed Buffer

Send Data for Read I/O Request Message

Address	15	8	7	0	Remarks
D700	00 hex		10 hex		Entire data length
D701	00 hex		04 hex		Message sequence number
D702	03 hex		E8 hex		Timeout monitor time
D703	00 hex		0A hex		Request data length
D704	4B hex		0A hex		Node address and service code
D705	03 hex		06 hex		Class ID
D706	00 hex		10 hex		Instance ID
D707	00 hex		00 hex		Offset size
D708	00 hex		02 hex		Read data size

Receive Data for Read I/O Response Message

Address	15	8	7	0	Remarks
D750	00 hex			08 hex	Receive data size
D751	00 hex			04 hex	Message sequence number
D752	00 hex			04 hex	Data size
D753	CB hex			0A hex	Node address and service code
D754	**			**	Read data

Note Refer to *Appendix 3: Explicit Messages* for detailed settings of the explicit messages.

A-6-8 Sample Ladder Programming for Each Process

This section provides sample programming for each process in the sample programming process flowchart.

Processing to Set Send Data

The messages to use are stored in the buffer in advance.

Initialization for Get Access Right Request Message

Initializing of [Get Access Right] message

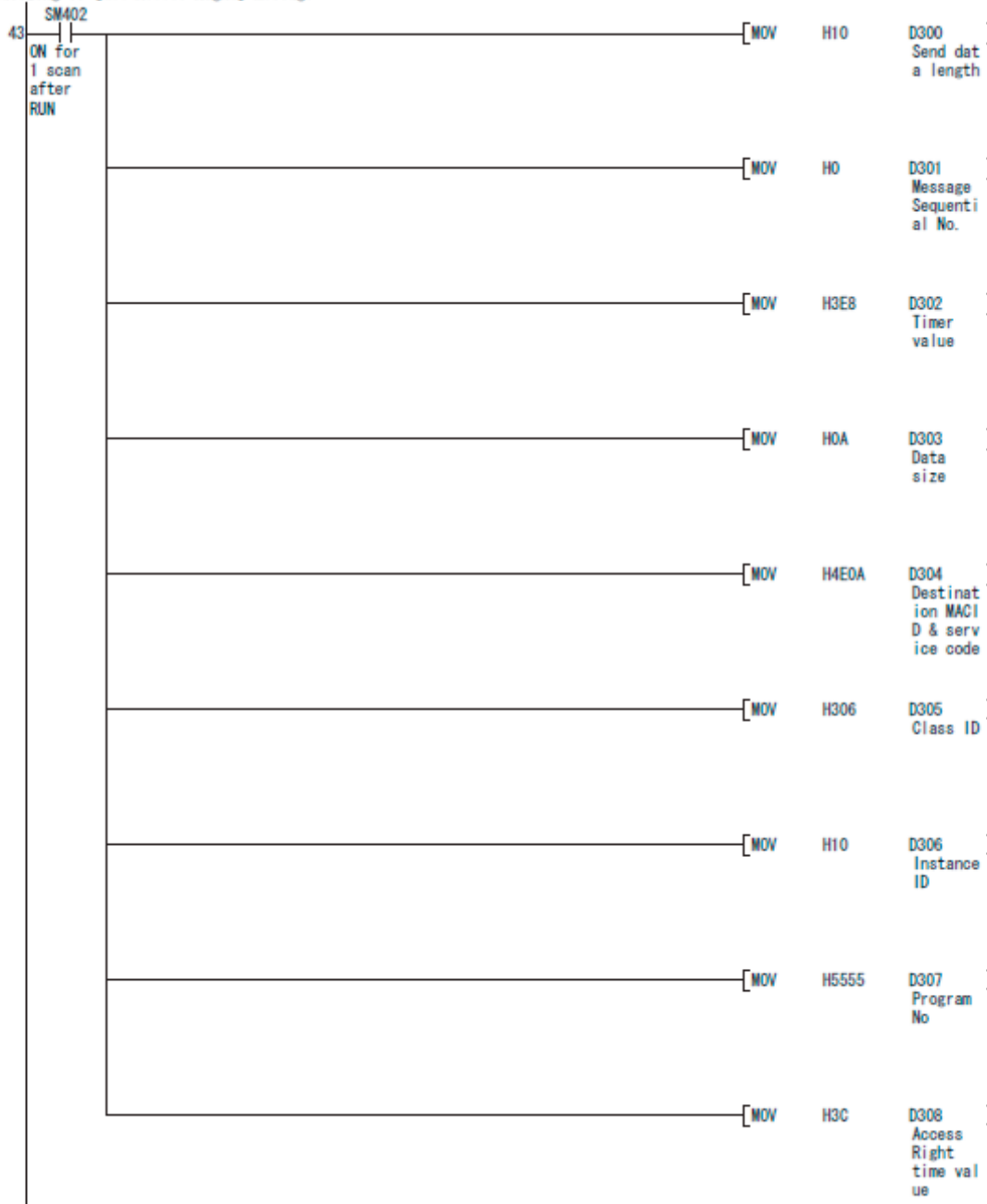

Initialization for Write I/O Request Message

Initializing of [I/O Write] message

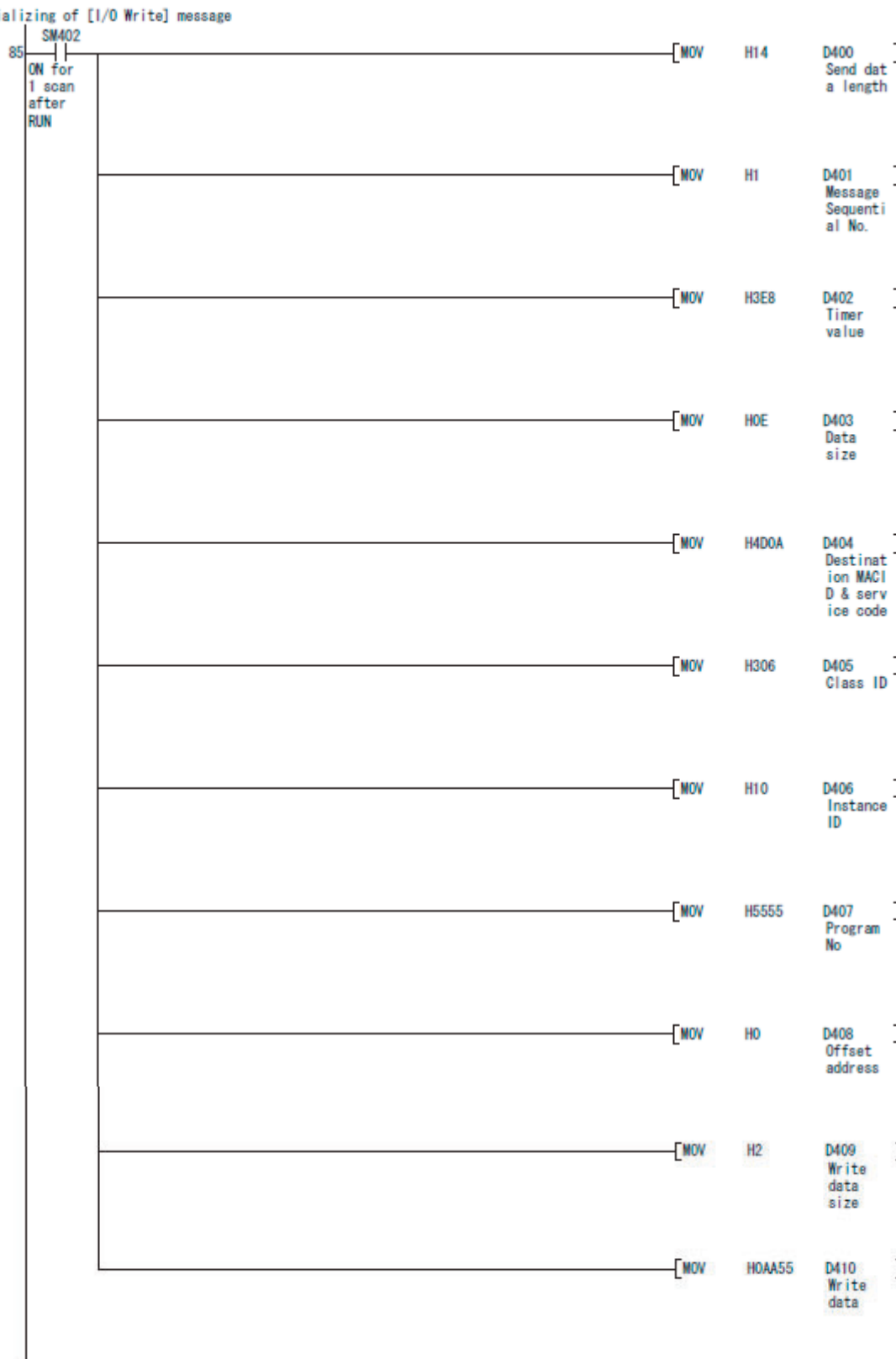

Initialization for Update Access Right Monitor Timer Message

Initializing of [Refresh Monitor time] message

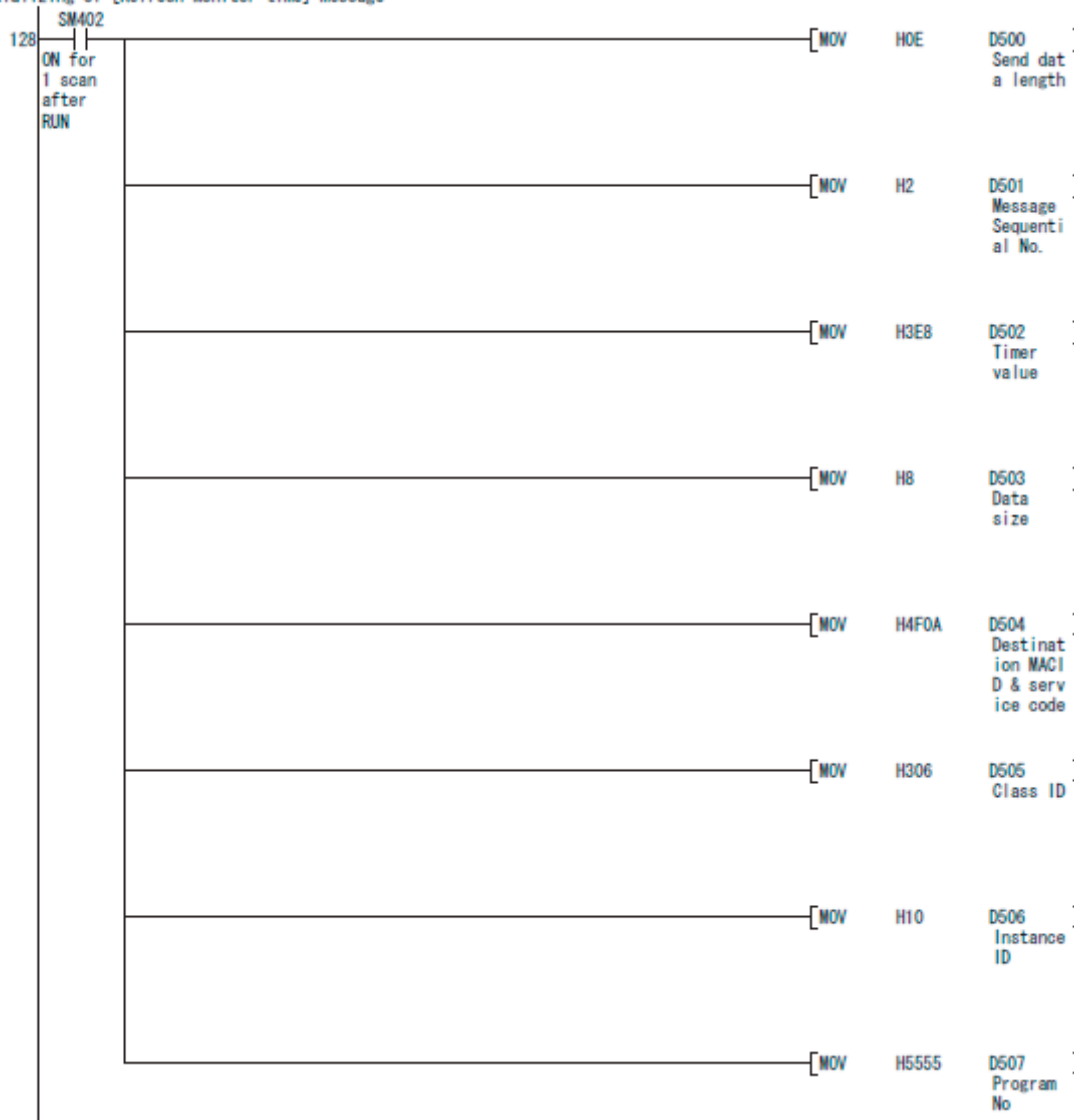

Initialization for Release Access Right Request Message

Initializing of [Release Access Right] message

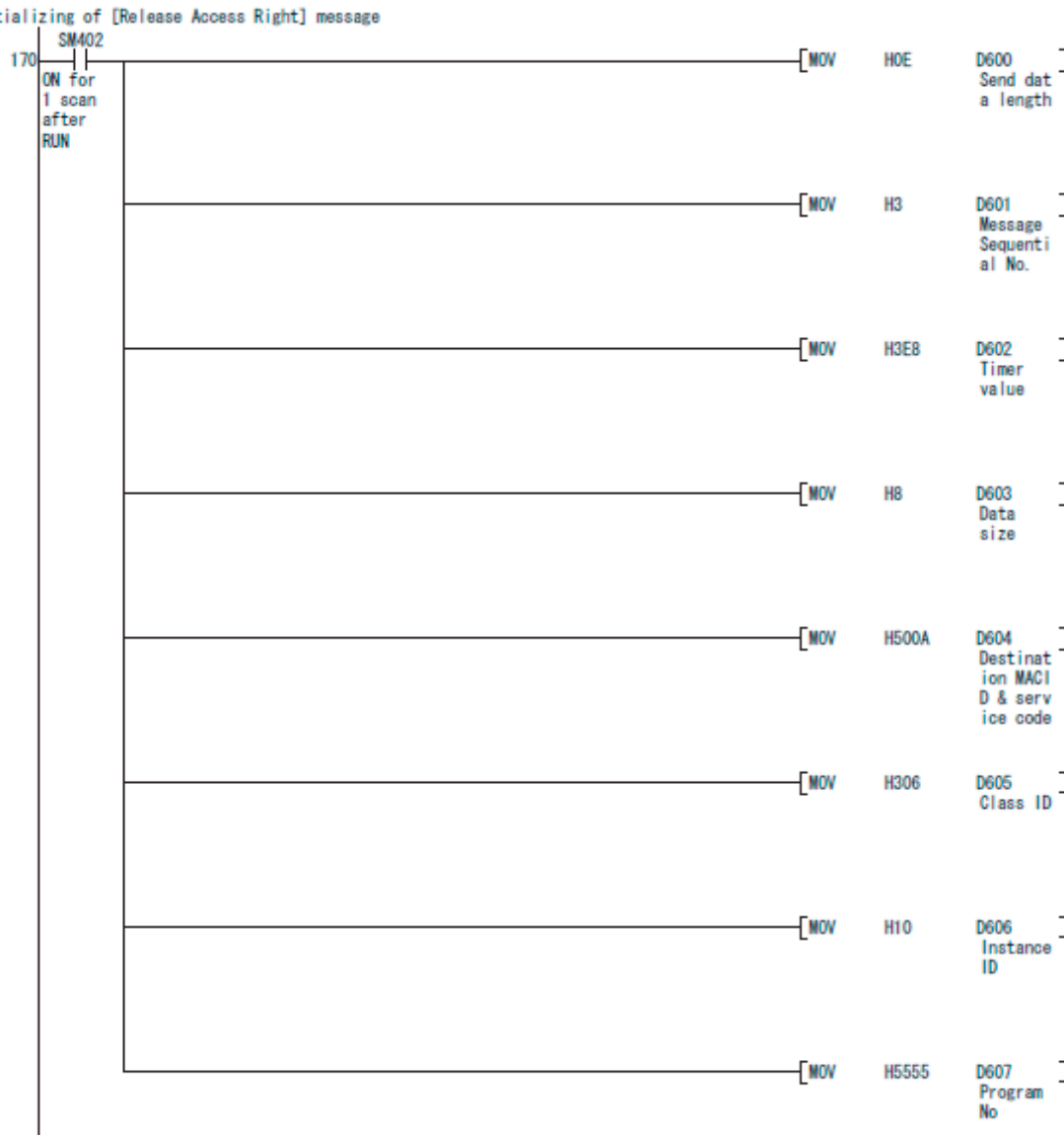

Initialization for Read I/O Request Message

Initializing of [I/O Read] message

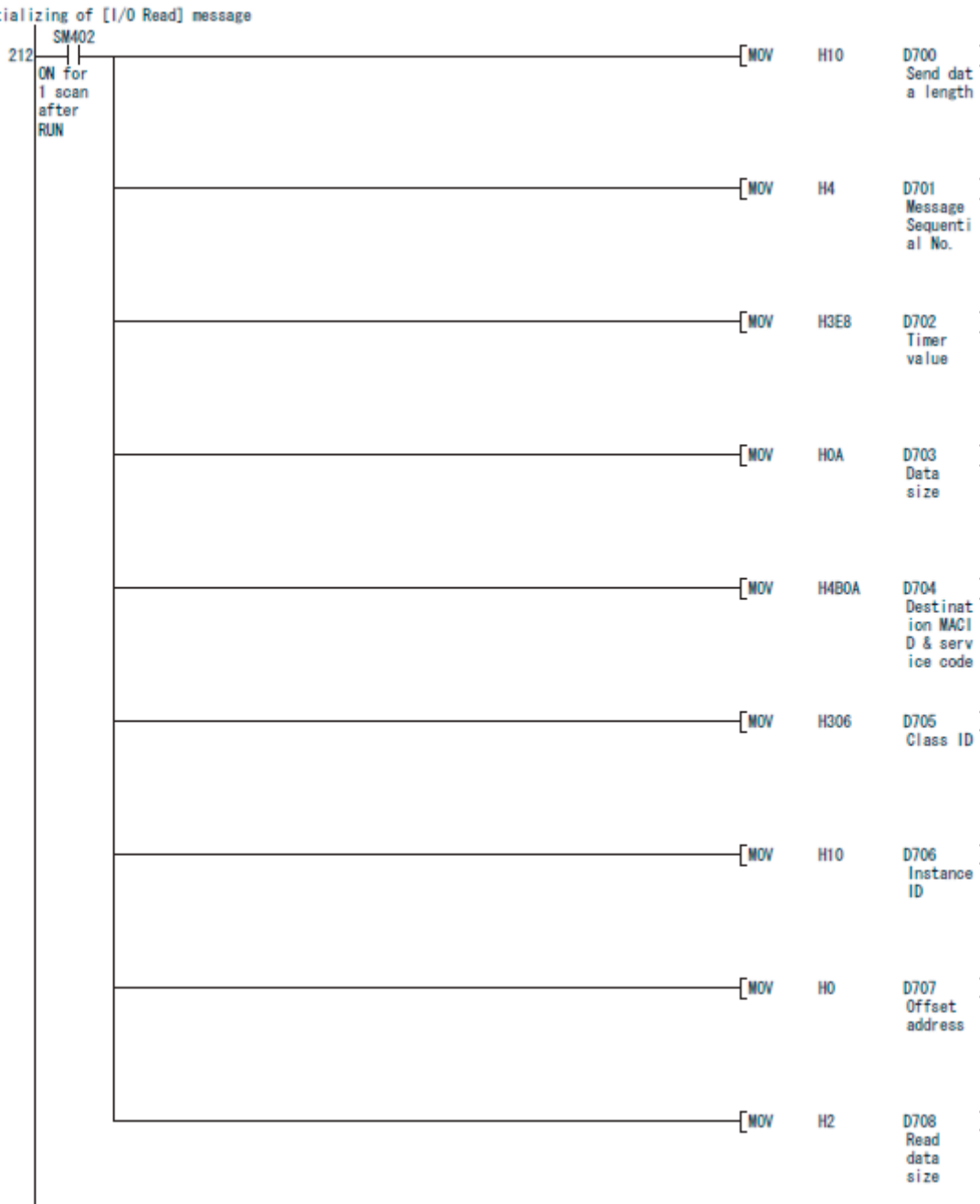

Connection Open Processing

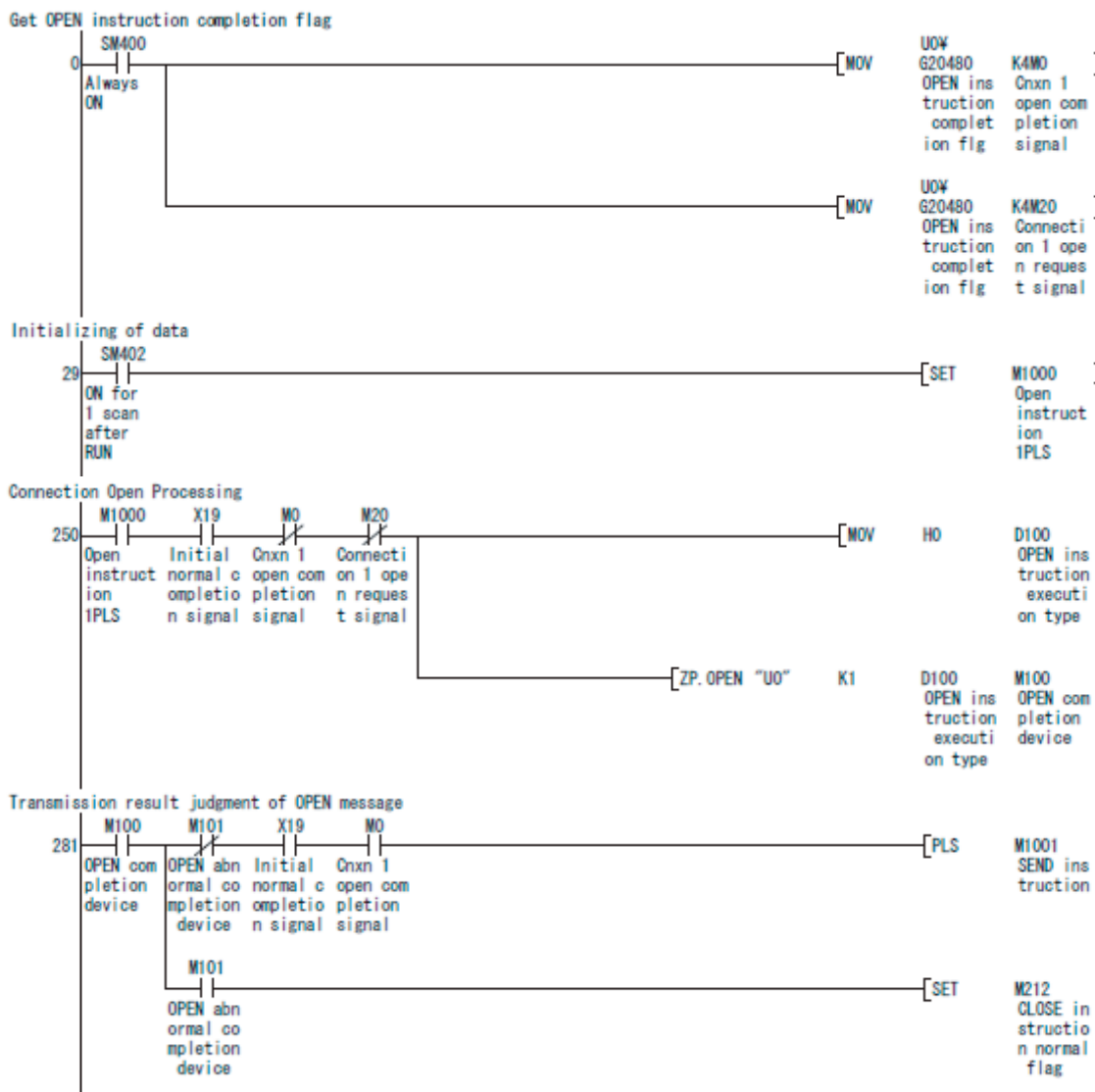

Message Send/Receive Processing

Send and receive processing is performed for each message.

Sending Get Access Right Request Message

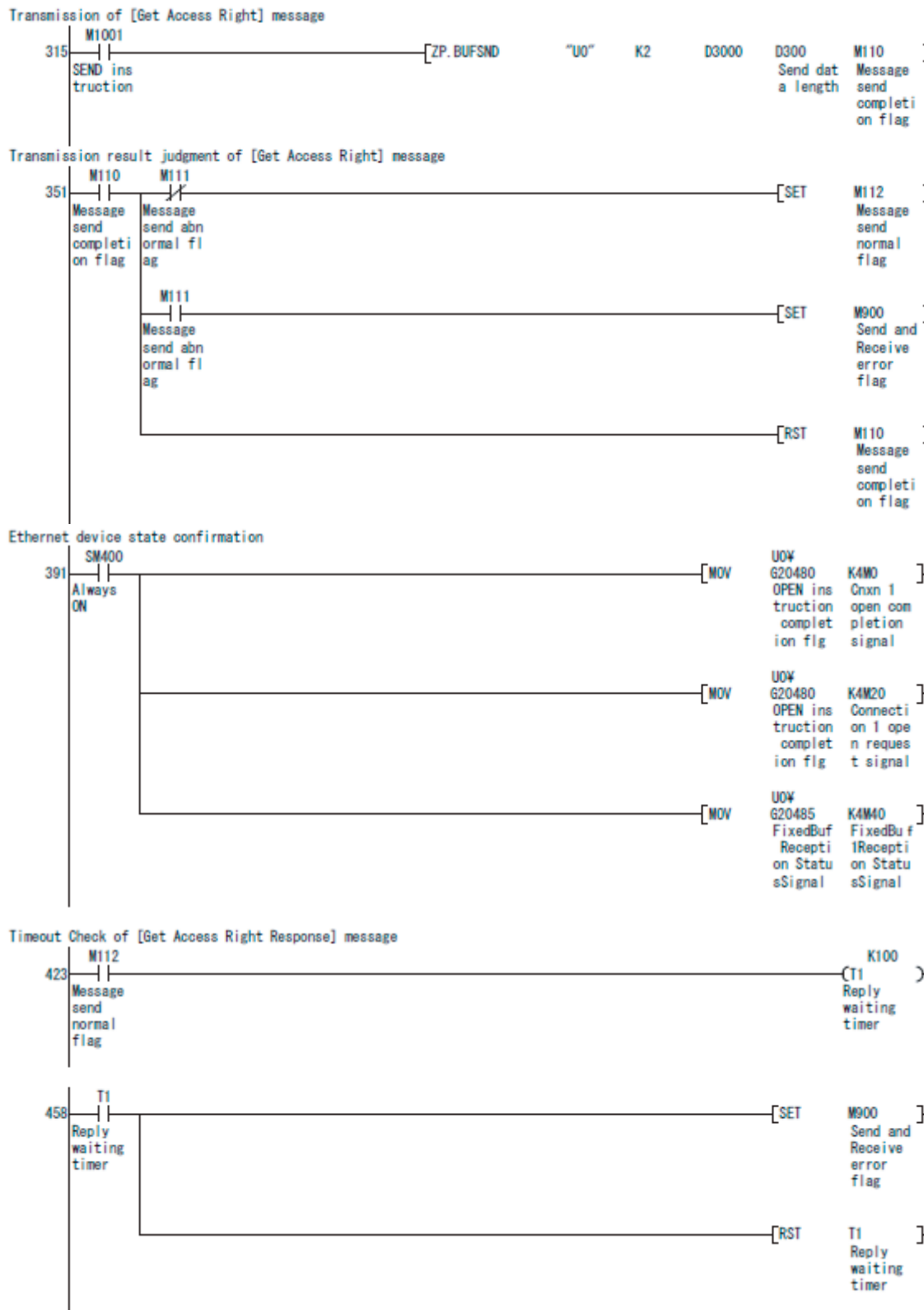

Receiving Get Access Right Response Message

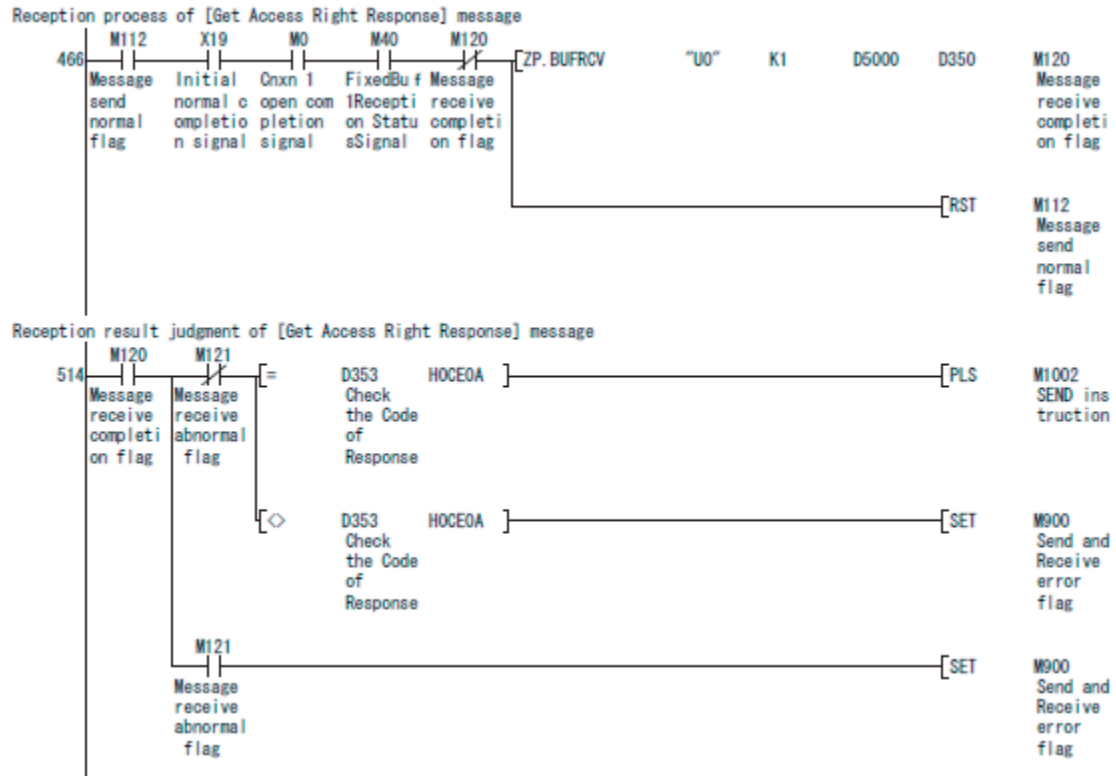

Sending Write I/O Request Message

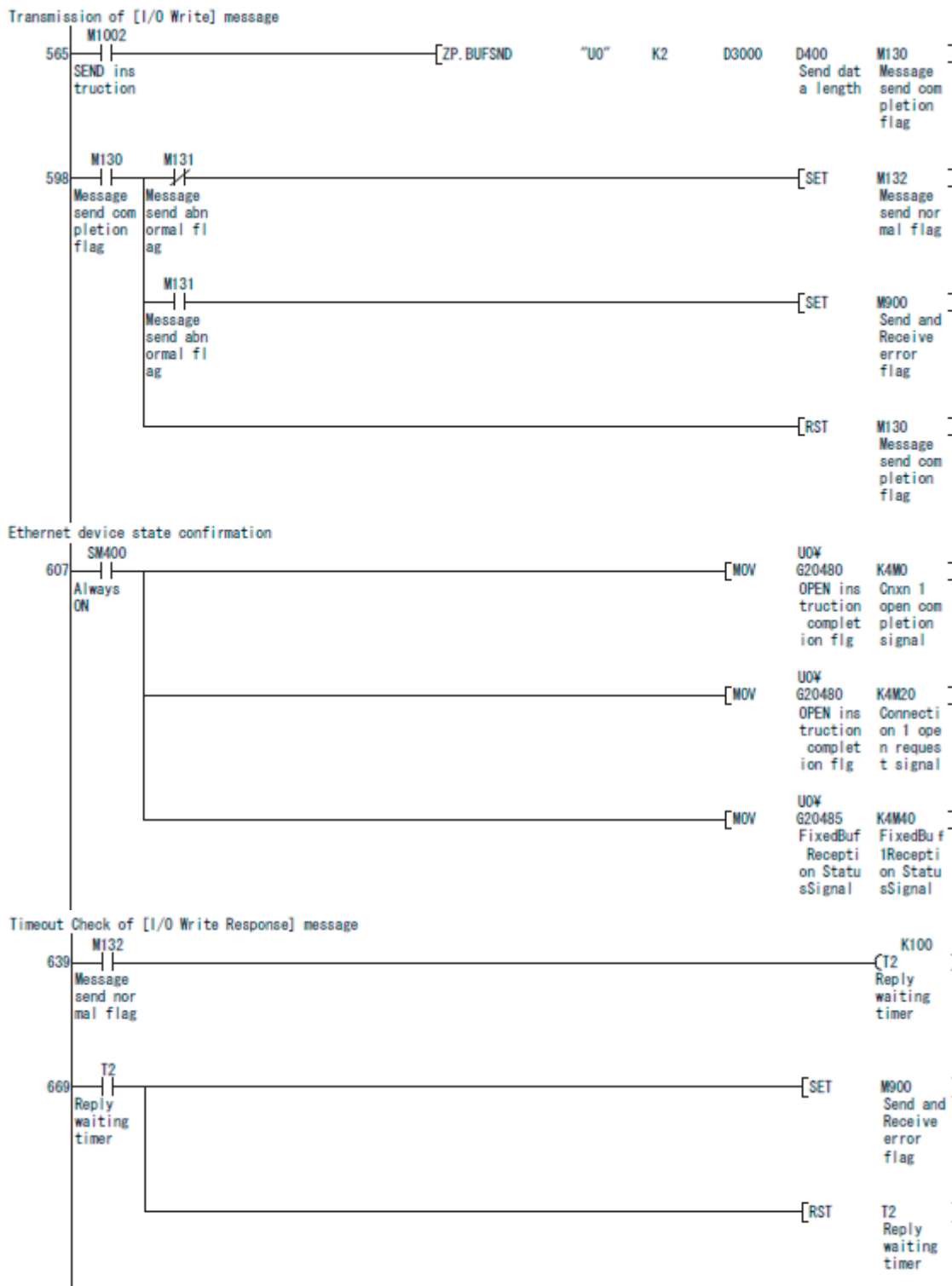

Receiving Write I/O Response Message

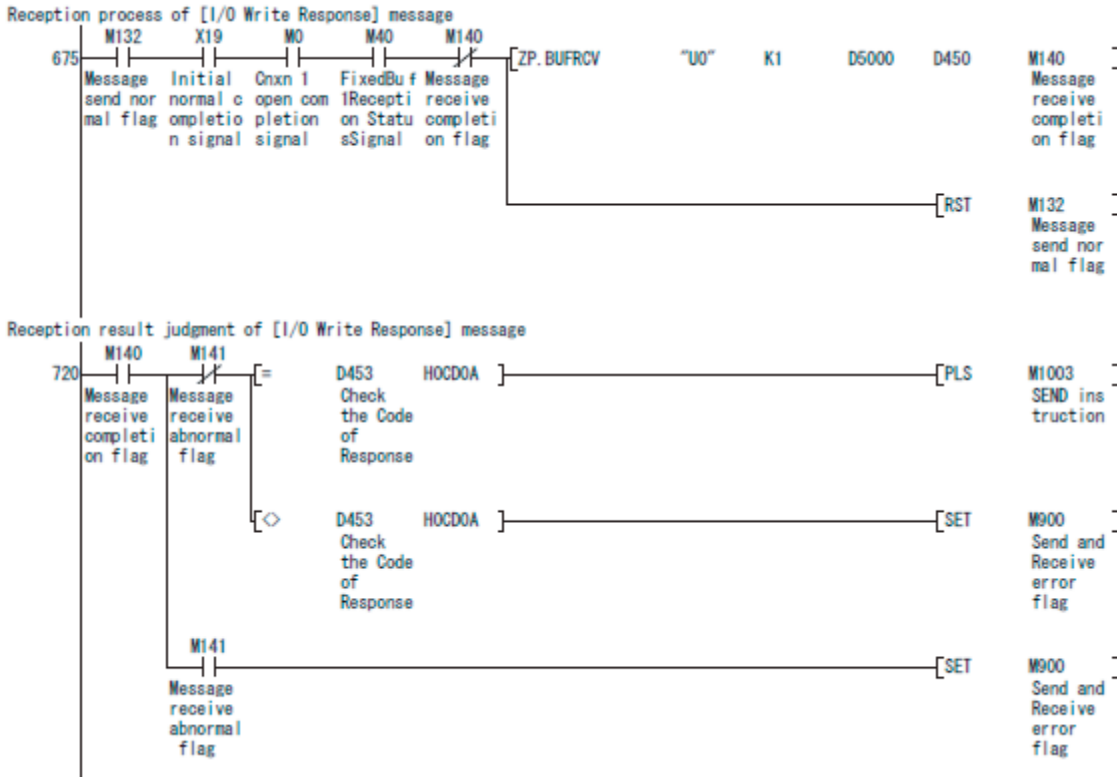

Sending Update Access Right Monitor Timer Request Message

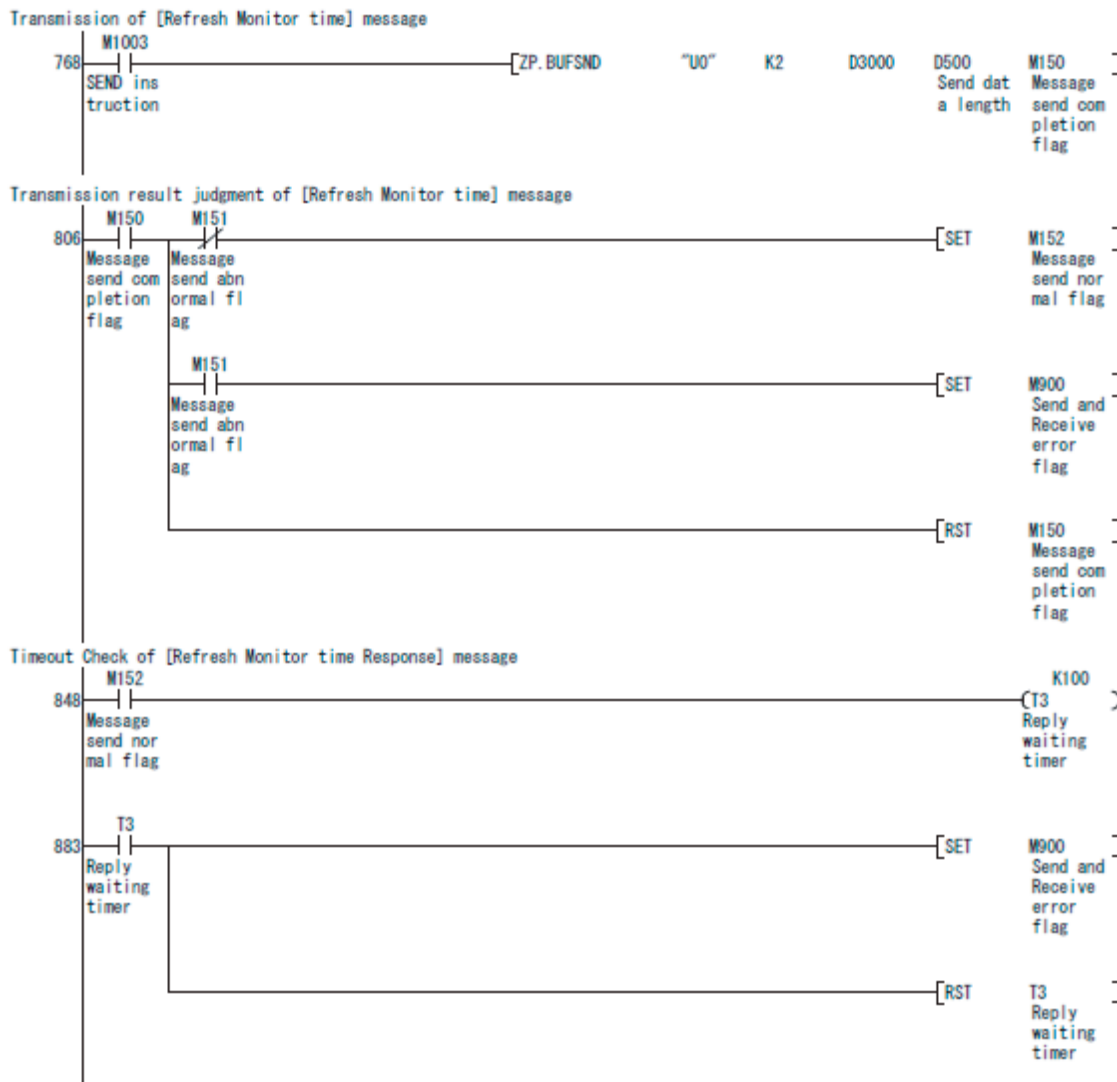

Receiving Update Access Right Monitor Timer Response Message

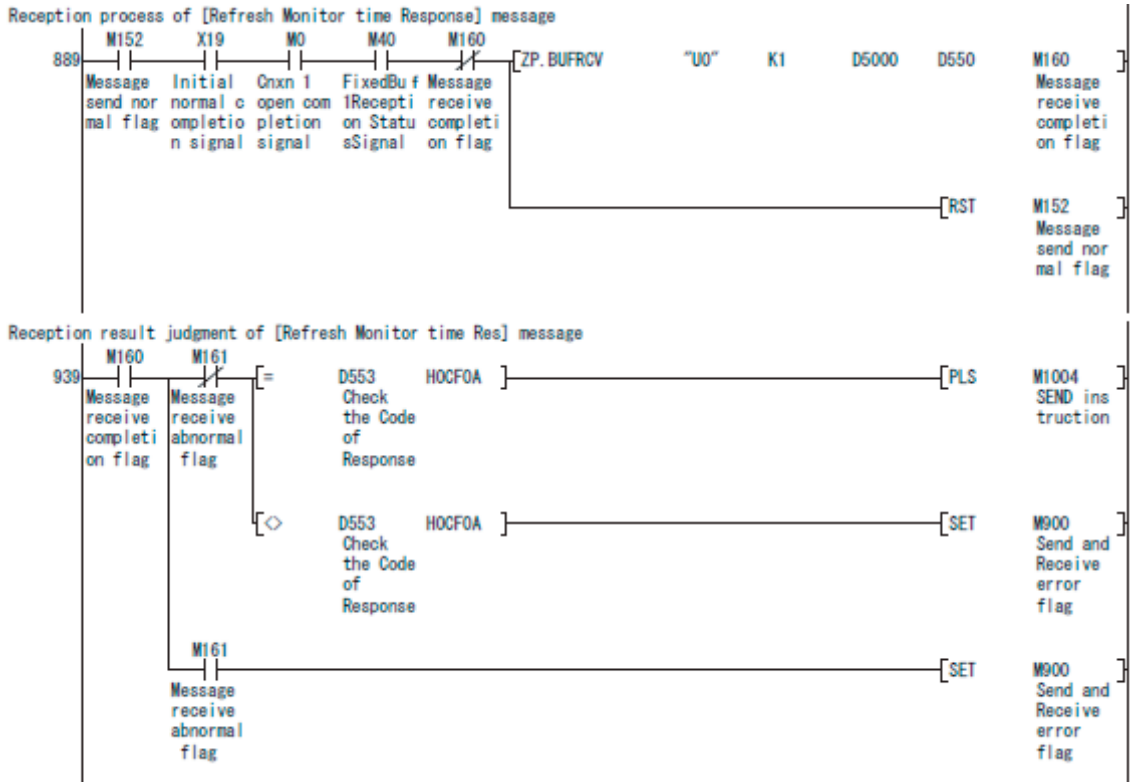

Sending Release Access Right Request Message

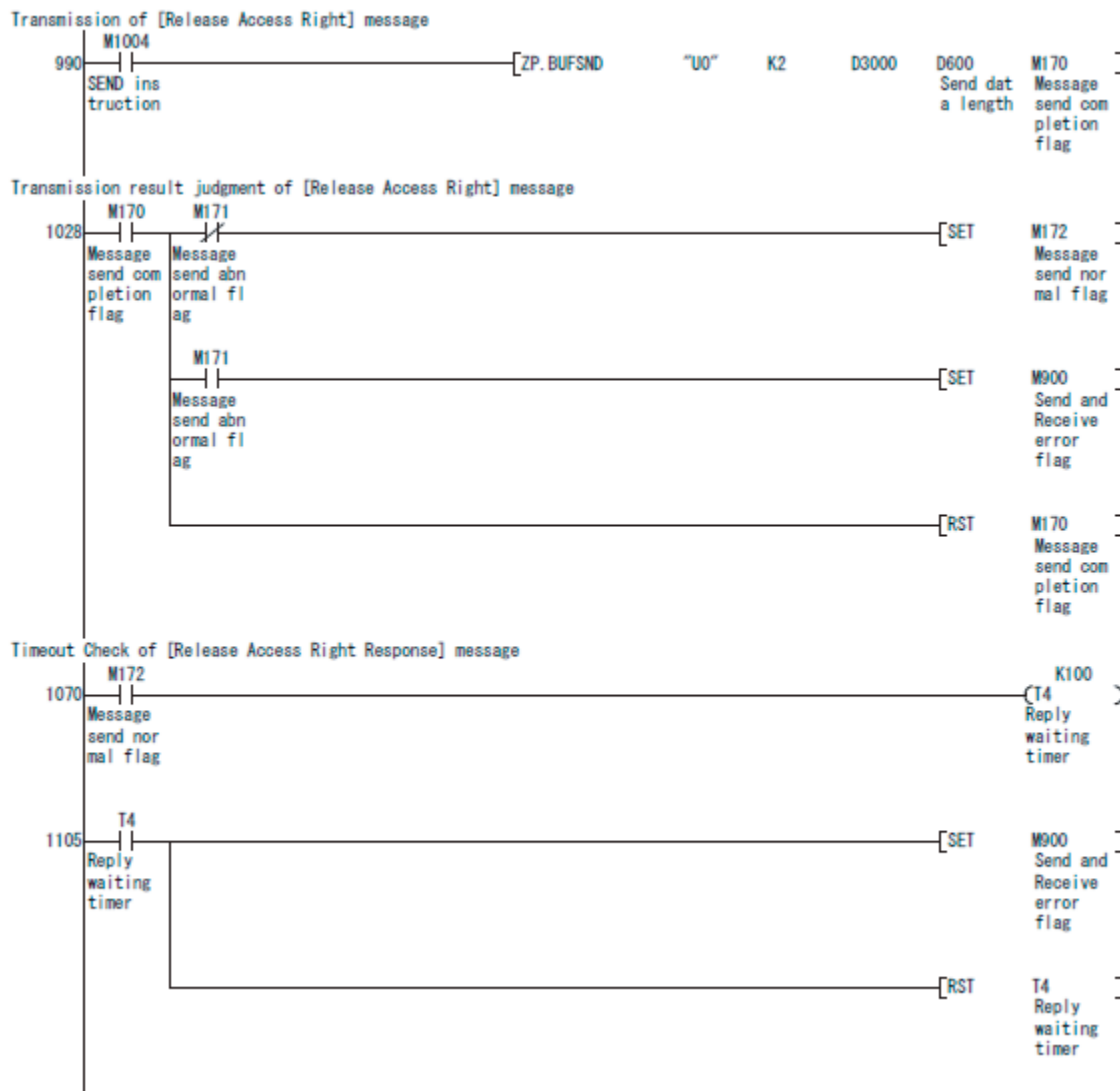

Receiving Release Access Right Response Message

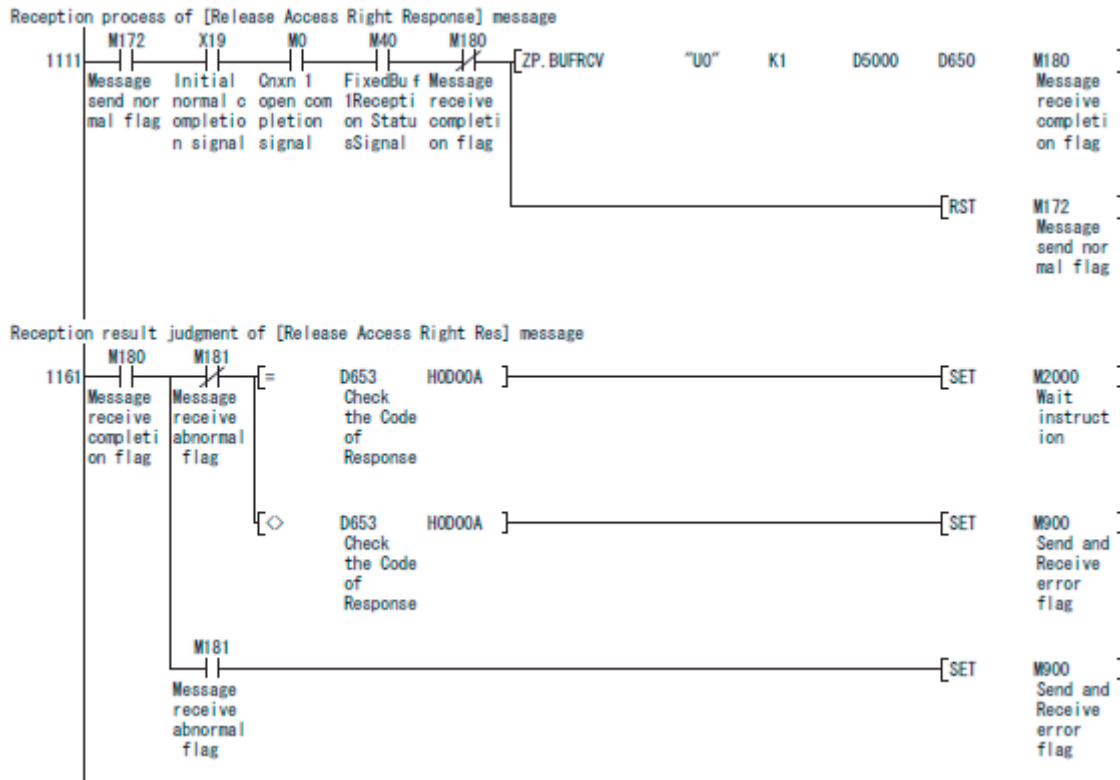

Sending Read I/O Request Message

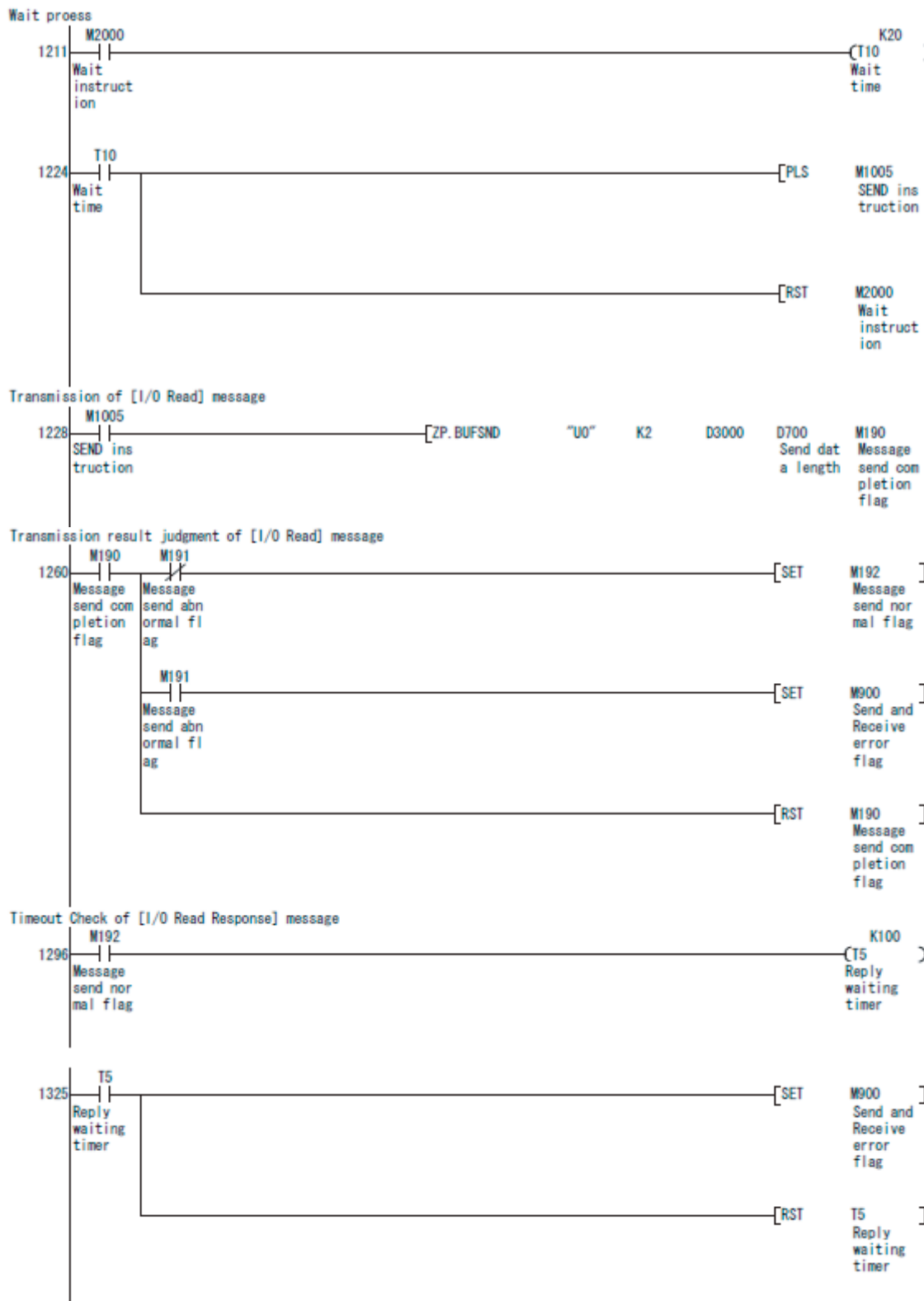

Receiving Read I/O Response Message

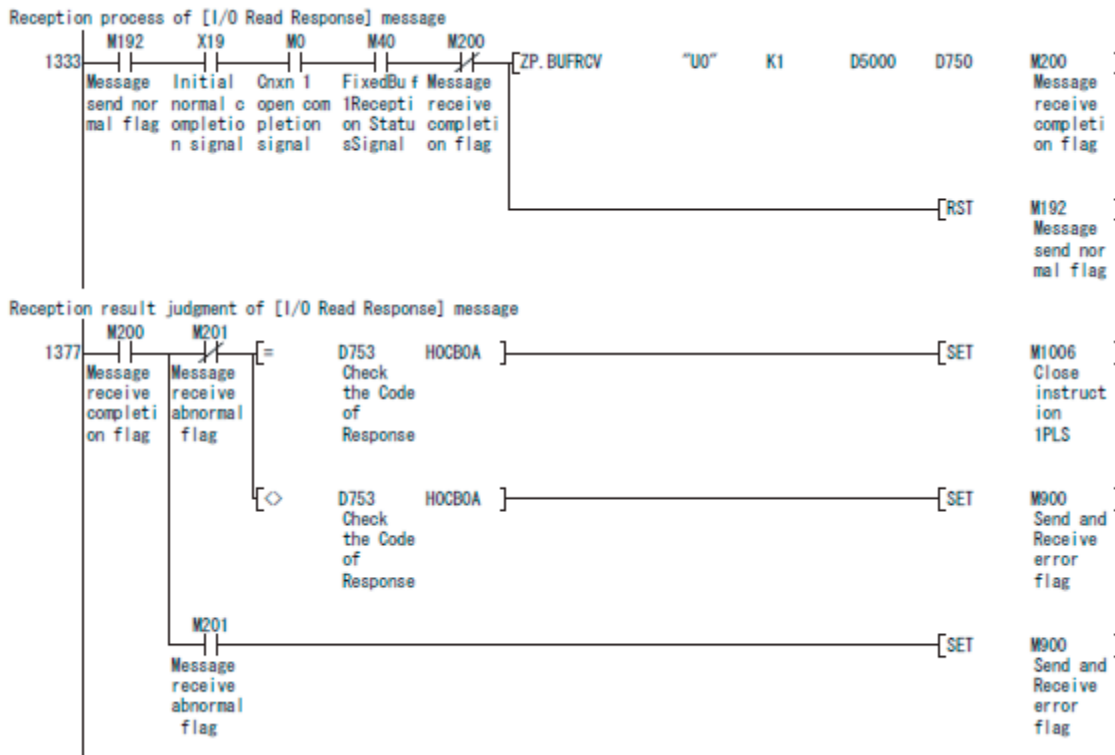

Connection Close Processing

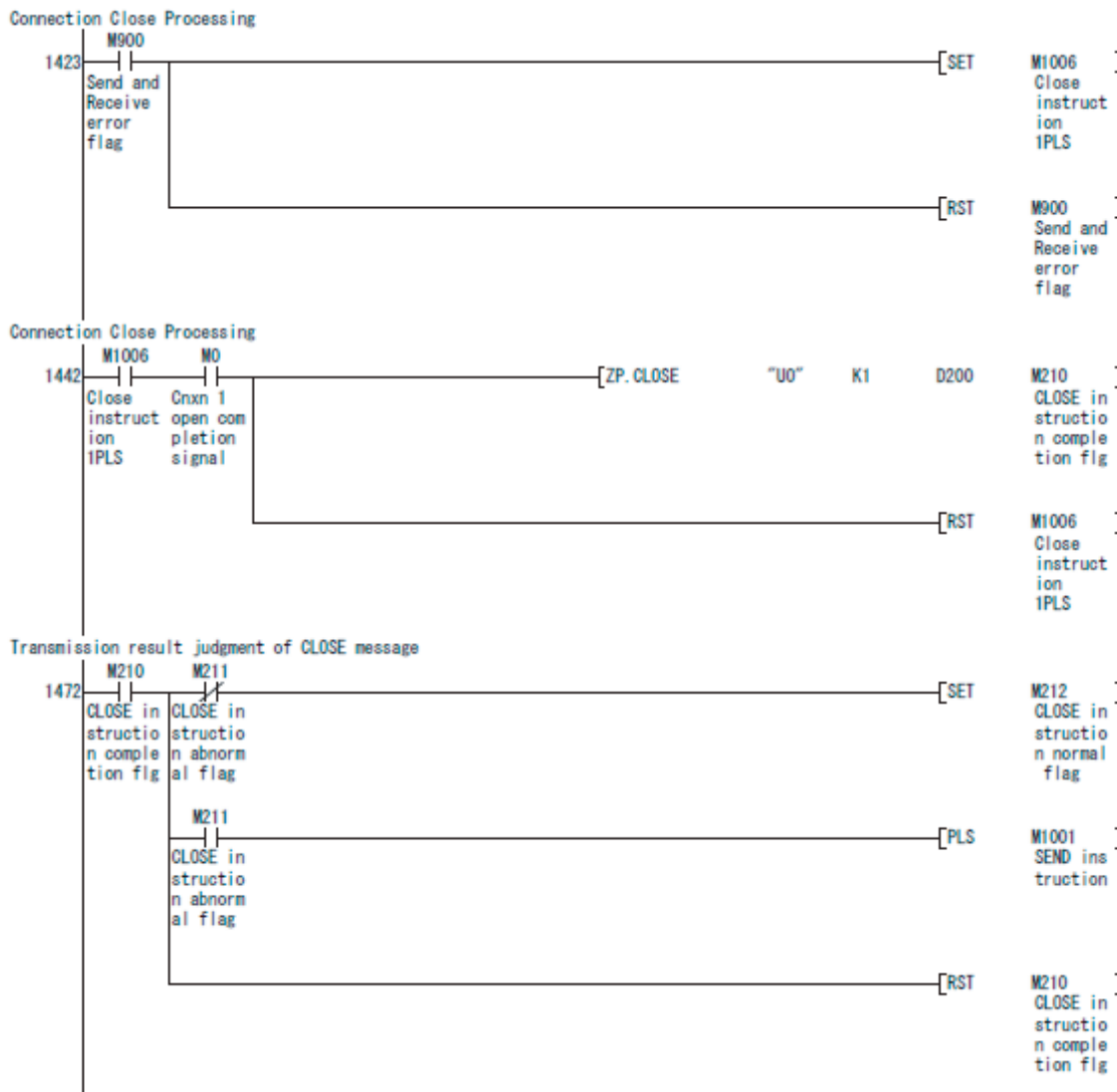

Processing after receiving CLOSE success response

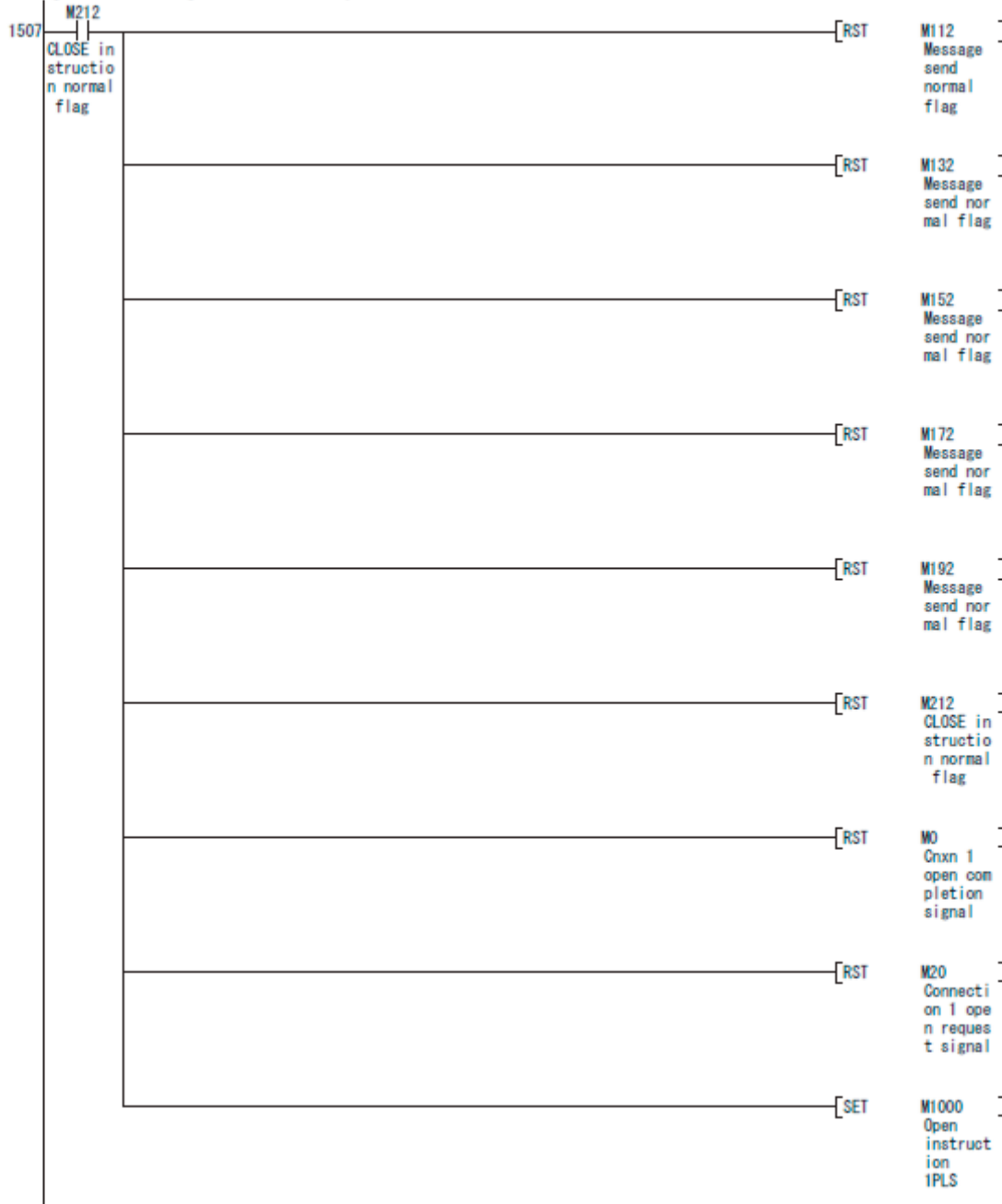

Glossary

Term	Definition
assembly	Internal data in a device gathered as one group to be accessed externally.
bit-strobe connection	One of the connection types for I/O communications in DeviceNet standard communications. For a bit-strobe connection, the Master broadcasts a message and the Slaves that receive the message return input data. Communications are performed on a communication cycle, just as for poll connections, but effective communications are possible for Input Slaves.
Busoff	Status that occurs when the error rate on the DeviceNet network is extremely high over a communications cable. An error is detected when the internal error counter in a device exceeds a certain threshold value. Countermeasures based on error corrective actions are required when a busoff occurs.
CAN	An acronym for Controller Area Network. CAN is a highly reliable yet low-cost communications protocol standardized by the ISO.
CIP	An acronym for Common Industrial Protocol. CIP is an open multivender communications protocol. It enables communications between various devices without restrictions due to network types or differences in devices. DeviceNet and EtherNet/IP and CIP networks.
CIP safety	A safety extension of the CIP that supports IEC 61508 SIL3 and EN 954-1 Safety Category 4. A safety layer is added to the CIP application layer so that traditional CIP communications and CIP safety communication can coexist simultaneously without interfering with each other, achieving highly reliable safety communications. DeviceNet Safety and EtherNet/IP Safety are CIP Safety-compliant networks based on DeviceNet and EtherNet/IP Safety.
configuration	Using the Network Configurator to built a network and set devices.
configuration data	The device setting parameters. Configuration data is set in devices using the Network Configurator. There are parameters related to safety functions and parameter not related to safety functions. Parameters related to safety functions are protected by a safety signature.
configuration lock	Indicates that device operation has been checked by user testing and that the parameters that have been set related to safety functions have been verified.
connection	A logical communications path used to communicate between devices.
connection type	The connection types are as follows depending on the communications method. DeviceNet Standard Communications <ul style="list-style-type: none"> • Poll connection • Bit-strobe connection • COS connection • Cyclic connection • Explicit message connection DeviceNet Safety Communications <ul style="list-style-type: none"> • Single-cast connection • Double-cast connection
COS connection	An acronym for Change of State. One of the connection types for I/O communications in DeviceNet standard communications. For this connection type, data is sent after a set period of time elapses, just as for a cyclic connection, but data can also be sent when data changes or a data send request is received from the application. Conditions depend on the device. A COS connection enables effective communications for changes in data or requests from applications without being dependent on the communications cycle of the Master. COS connections cannot be used at the same time as cyclic connections.
CPU Unit without EtherNet/IP	A CPU Unit with one of the following model numbers: NE1A-SCPU01(-V1) or NE1A-SCPU02.

Glossary

Term	Definition
CPU Unit with EtherNet/IP (Unit supporting EtherNet/IP)	A CPU Unit with one of the following model numbers: NE1A-SCPU01-EIP or NE1A-SCPU02-EIP
cyclic connection	One of the connection types for I/O communications in DeviceNet standard communications. For a cycle connection, data is sent after a set period of time elapses. A cyclic connection enables sending data on a cycle that is different from the communications cycle of the Master.
DeviceNet	A CIP-compliant network that uses CAN technology. DeviceNet is mainly used as a field network to connect controllers, sensors, and other devices.
DeviceNet Safety	A DeviceNet that complies with CIP Safety, i.e., IEC 61508 SIL3 and EN 954-1 Safety Category 4.
discrepancy time	The time period from a change in one of two inputs until the other input changes. When using a dual-channel input, a suitable time must be set depending on the characteristics of the connected devices.
dual channel	Using two inputs or outputs as the input or output for redundancy.
Dual Channel Complementary	Setting to evaluate that two logic states are complementary.
Dual Channel Equivalent	Setting to evaluate that two logic states are equivalent.
EPI	An acronym for Expected Packet Interval. The interval of safety data communications between the Safety Master and the Safety Slave through an established connection.
error latch time	The time period to hold an error state (control data, status data, and LED indications).
EtherNet/IP	A CIP-compliant network that uses TCP/IP technology. EtherNet/IP can coexist with other TCP/IP-based protocols in high-capacity, high-speed networks.
explicit message connection	A connection type for explicit messages in DeviceNet standard communications.
Fault Present	Several function blocks have Fault Present as an optional output. This is an error output that indicates that the applicable function block has detected an internal logic error or an input data timing error.
multicast connection	One of the connection types for DeviceNet Safety communications. With a multicast connection, multicast input data can be sent from a Safety Slave to up to 15 Safety Masters. This connection type can be set only for a Safety Slave input. It cannot be set for outputs. This connection type enables effective communications when sharing the data from one Safety Slave between more than one Safety Master.
Network Configurator	A software tool used to set networks and devices for CIP and CIP Safety.
node	A generic name for devices to which addresses are allocated in a network. Nodes are sometimes also called devices.
offline	The state in which a device is not connected to the network or in which communications are not possible because they have not been set from the Network Configurator.
online	The state in which communications through the network are possible.
open type	The opening method for a safety connection. One of three types is selected in the settings of a connection to the Safety Master. Refer to 5-1 Setting Safety Connections in the <i>DeviceNet Safety System Configuration Manual</i> (Cat. No. Z905-E1-07 or higher) for details. <ul style="list-style-type: none"> • Configuring the target device • Checking the safety signature • Only opening
PFD	An acronym for Probability of Failure on Demand. Shows the average failure rate for a system or device demand. Used for calculating the SIL (Safety Integrity Level) for a safety system.
PFH	An acronym for Probability of Failure per Hour. Shows the failure rate per hour for a system or device. Used for calculating the SIL (Safety Integrity Level) for a safety system.

Glossary

Term	Definition
poll connection	<p>One of the connection types for I/O communications in DeviceNet standard communications.</p> <p>For a poll connection, output data is sent from the Master and Slaves that receive the output data return input data. This connection type is used for cyclic communications with Slaves that have both inputs and outputs.</p>
reaction time	The worst-case response time required to move the system to a safe state after a safety input occurs (e.g., an emergency stop switch is pressed, a light curtain is interrupted, or a safety door is opened) or a device fails. The system reaction time includes the reaction time of sensors and actuators, just as it includes the reaction time of controllers and networks.
safe state	The state of a component or device when the risk of human harm reduced to a permissible level.
safety chain	The logical chain to actualize a safety function, that consists of the input device (sensor), the control device (including a remote I/O device), and the output device (actuator).
safety controller	A controller with high reliability used for safety control. A safety network controller is a controller that is compatible with a safety network. Safety controllers and safety network controllers are sometimes generically referred to as safety PLCs.
safety network controller	
safety data	Extremely reliable data, with the risk of human harm reduced to a permissible level.
safety function	A function executed by a safety-related system to achieve a safe state for a machine hazard.
safety network number	<p>A unique number set for a safety network. With CIP Safety, a system can be built that included multiple networks. In this type of configuration, devices are uniquely identified and mutually confirmed using a TUNID that combines the network number and node address.</p> <p>The Network Configurator automatically sets network numbers for communications. Network numbers can also be specified by the user.</p>
safety protocol	The communications hierarchy added to actualize highly reliable communications.
safety signature	A certificate of the configuration data issued to a device from the Network Configurator. The device verifies that the configuration data is correct by using the safety signature.
single channel	Using only one input or output as the input or output.
single-cast connection	<p>One of the connection types for DeviceNet Safety communications.</p> <p>With a single-cast connection, a Safety Master and Safety Slave communications 1:1. This connection can be set for either an input or an output, and separate connections are needed for each.</p>
standard	In this manual, items used for general control purposes are called “standard” to differentiate them from devices, functions, data, and other items for which safety measures have been applied.
Standard CPU Unit	A CPU Unit used for standard control, such as CPU Units in OMRON’s CS or CJ Series. This term is used to differentiate from Safety CPU Units.
test pulse	A signal used to detect external wiring coming into contact with the power supply (positive) or short circuits between signal lines.
TUNID	<p>An acronym for Target Unique Network Identifier.</p> <p>The TUNID is the UNID of the local node. The TUNID is automatically set when configuring devices with the Network Configurator. The set TUNID is saved in nonvolatile memory in the device and used in the future.</p>
UNID	<p>An acronym for Unique Network Identifier.</p> <p>An ID used to uniquely identify once device in and configuration of multiple networks. The UNID consists of the Safety Network number and node address.</p>

Glossary

Index

A

abort, 28, 70
abort errors, 244, 247
ABORT State, 222
access control, 219
AND, 149, 155
automatic baud rate detection, 71

B

baud rate, 107
baud rate setting, 30, 71
baud rate switch, 30

C

calculated PFD values, 290
calculated PFH values, 290
centralized monitoring system, 11
COMM, 26
communication connectors, 64
Comparator, 163
configuration lock, 216
configuration lock status, 26
CONFIGURING Mode, 222
connection type setting, 89, 90
contact operation counter, 129
contact operations alarm threshold, 129
Counter, 210
creating a send message, 124
CRITICAL ERROR State, 222
critical errors, 244, 246
cycle time, 231

D

data expected packet interval setting, 89, 91
default gateway, 107
DeviceNet communications connector, 31
DeviceNet communications specifications, 38
discrepancy error, 138, 139
discrepancy time, 137, 150, 152
distributed safety control system, 11
dual channel, 141

dual channel complementary, 137, 150
dual channel complementary (2 pairs), 150
dual channel equivalent, 137, 138, 150
dual channel equivalent (2 pairs), 150
dual channel mode setting, 137, 141

E

EDM, 149
emergency stop pushbutton monitoring, 149, 171
Enable Switch, 206
EPI (data expected packet interval) setting, 89
error detected during self-diagnosis, 139, 142
error history, 246, 251
error history saving area, 253
error history table, 253
error latch time, 139, 143
example for dual channel equivalent setting, 152
Exclusive NOR, 149, 161
Exclusive OR, 149, 160
EXNOR, 149
EXOR, 149
external device monitoring, 149, 188

F

fault present setting, 154
function block editing, 150
function block parameter settings, 150
function blocks, 149, 150
function tests, 153

G

gateway
 default gateway, 107
general precautions, xviii
general status, 95, 96, 99, 100, 109
glossary, 345

I

I/O comments, 128
I/O connection settings, 89
I/O power monitor, 129

I/O refresh cycle time, 234
I/O tags, 74, 96, 99, 110, 128, 137, 142
I/O type, 96, 99, 109
IDLE Mode, 222
IN 0 to 15, 26
IN 0 to 39, 26
input and output size settings, 153
input channel mode, 136
input OFF delays, 136
input ON delays, 136
input tags, 147
input type settings, 150
input/output terminals and internal connections, 32
inspection, 272
IP address, 106

L

laws and regulations, xix
LED indicators, 26
light curtain monitoring, 149, 174
Local Input Monitor, 85
Local Input Status, 26, 84, 95, 96, 99, 100, 109
local inputs, 118
Local Output Monitor, 86
Local Output Status, 26, 85, 95, 96, 99, 100, 109
local outputs, 118
local safety I/O, 3
LOCK, 26
LOCK LED, 216
logic functions, 146, 149
lost password, 219

M

mode setting, 141
module status, 26
monitoring control system, 9, 10
MS, 26
Multi Connector, 212
multicast, 90
multicast connection, 90
muting, 190

N

NE1A-series, 3
network configurator, 19
network reaction time, 235
node address duplication, 30
node address duplication error, 70
node address setting, 70
node address switches, 30
nomenclature, 22
nonfatal errors, 244, 247
non-safety data, 85, 96
NOT, 149, 155

O

OFF-delay timer, 149, 184
ON-delay timer, 149
online monitoring, 6
open type setting, 89, 90
operating mode, 222
operating mode changes, 225
operating mode setting at startup, 225
OR, 149, 158
OUT 0 to 7, 26
outline of programming, 146
output channel mode, 141
output points setting, 153
output tags, 147

P

password, 219
power supply terminal for external input devices and test outputs, 32
power supply terminal for external output devices, 32
power supply terminal for internal circuits, 32
program capacity, 148
Pulse Generator, 208

R

reaction time, 237
reaction time calculation, 238
reaction time calculation examples, 238
reading and clearing the error history table, 253

remote I/O area, 74
remote I/O area attributes, 75
Remote I/O Area Data Configuration, 76
reset, 149, 166, 217
Reset Set Flip-Flop, 161
reset types, 217
resetting errors, 139, 143
restart, 149, 169
routing, 149, 189
RUN Mode, 222

S

safety chain, 237, 242
safety connections, 89
safety control system, 9, 10
safety data, 84, 85, 91
safety gate monitoring, 149, 176
safety I/O communications, 3, 89
safety input, 136
safety input terminals, 32
safety master, 88
safety network controller, 2
safety output terminals, 32
safety precautions, xx
safety signature, 90
safety slave, 88, 95
safety slave I/O, 116
selecting the I/O type, 96
SELF-DIAGNOSTIC Mode, 222
send condition setting, 124
setting additional status, 96, 99, 110
setting I/O tags, 96
setting slave I/O, 99, 110
seven-segment display, 28
single channel, 137, 141, 150
single-cast, 90
single-cast connection, 90
slave I/O, 98
slave I/O area hold setting, 75
software setting, 30, 70
standalone controller, 72
standard I/O communications, 3, 98, 108
standard slave, 98, 108
standards, xviii

subnet masks, 106
supported function blocks, 149
synchronization time setting, 153
system configuration, 8

T

test output mode, 140
Test Output/Muting Lamp Status, 85, 95, 96, 99, 100, 109
test outputs, 118
test source, 136
total ON time alarm threshold, 133
total ON time monitor, 131
trigger address setting, 124
two inputs evaluated, 137
two-hand control, 181
two-hand controller, 149

U

USB communications connector, 31
USB communications status, 26
user mode switch, 149, 186

W

waiting for TUNID setting, 223
wiring input devices, 54
wiring output devices, 55

Revision History

A manual revision code appears as a suffix to the catalog number on lower left corners of the front and back covers of the manual.

Cat. No. Z906-E1-10

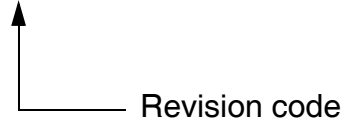

The following table outlines the changes made to the manual during each revision. Page numbers refer to the previous version.

Revision code	Date	Revised content
01	April 2005	Original production
02	April 2006	<p>Page 16: Regulations and standards modified.</p> <p>Page 34: Seven-segment display information modified.</p> <p>Page 38: Information added on DeviceNet communications specifications.</p> <p>Page 59: Information added on node address setting.</p> <p>Page 60: Information added on baud rate setting.</p> <p>Page 63: Seven-segment display information modified.</p> <p>Pages 64 to 67: Information added on Remote I/O Area data configuration.</p> <p>Page 80: Information added on explicit message transmission.</p> <p>Pages 88 and 92: Information added on error latch time setting.</p> <p>Page 103: Information changed on number of inputs and outputs setting.</p> <p>Page 103: Information changed on output points setting.</p> <p>Pages 114 and 116: Headings changed.</p> <p>Pages 113, 118, 121, 124, and 128: Information changed on optional output setting.</p> <p>Pages 126 and 134: Information added on error handling and resetting.</p> <p>Pages 154 to 157: Information added on calculating reaction times.</p> <p>Page 161: Information added on indicator status.</p> <p>Page 166: Information added on error history table.</p> <p>Page 167: Information added to error information details.</p> <p>Pages 169 to 172: Information changed and added on corrections in response to display messages.</p> <p>Pages 173 to 176: Information added on connection status tables.</p> <p>Page 184: Changes and additions made to glossary.</p>
03	September 2006	Information added describing the functions added to the NE1A-SCPU01-V1 unit version 1.0 and NE1A-SCPU02 unit version 1.0 Controllers.
04	June 2007	Information added describing the functions added to the NE1A-SCPU01-V1 unit version 2.0 and NE1A-SCPU02 unit version 1.0 Controllers.
05	December 2007	Added descriptions and corrected mistakes.
06	April 2008	Added descriptions and corrected mistakes.
07	July 2009	Added descriptions on the NE1A-SCPU01-EIP and NE1A-SCPU02-EIP.
08	May 2011	Information added describing the functions added to the NE1A-SCPU01-EIP unit version 1.1 and NE1A-SCPU02-EIP unit version 1.1 Controllers.
09	May 2021	<p><i>Terms and Conditions Agreement</i></p> <p>Updated descriptions.</p> <p><i>6. Regulations and Standards</i></p> <p><i>Added Conformance to KC Certification.</i></p> <p><i>13-2 NE1A-series Controller Replacement</i></p> <p>Deleted an incorrect note.</p>
10	October 2022	Revisions for adding safety precautions regarding security.

OMRON Corporation Industrial Automation Company

Kyoto, JAPAN

Contact : www.ia.omron.com

Regional Headquarters

OMRON EUROPE B.V.

Wegalaan 67-69, 2132 JD Hoofddorp
The Netherlands
Tel: (31) 2356-81-300 Fax: (31) 2356-81-388

OMRON ASIA PACIFIC PTE. LTD.

438B Alexandra Road, #08-01/02 Alexandra
Technopark, Singapore 119968
Tel: (65) 6835-3011 Fax: (65) 6835-2711

OMRON ELECTRONICS LLC

2895 Greenspoint Parkway, Suite 200
Hoffman Estates, IL 60169 U.S.A.
Tel: (1) 847-843-7900 Fax: (1) 847-843-7787

OMRON (CHINA) CO., LTD.

Room 2211, Bank of China Tower,
200 Yin Cheng Zhong Road,
PuDong New Area, Shanghai, 200120, China
Tel: (86) 21-5037-2222 Fax: (86) 21-5037-2200

Authorized Distributor:

©OMRON Corporation 2005-2022 All Rights Reserved.
In the interest of product improvement,
specifications are subject to change without notice.

Cat. No. Z906-E1-10 1022